

LSRD-6 Datasheet



Think Automation and beyond...

DiGi Electronics Part Number	LSRD-6-DG
Manufacturer	IDEC
Manufacturer Product Number	LSRD-6
Description	CONFIG SWITCH LAMP LED WHITE 6V
Detailed Description	Configurable Switch Lamp LED 6V

<https://www.DiGi-Electronics.com>

This model LSRD-6 is available at DiGi Electronics.

DiGi Electronics offers a global database of semiconductor and electronic component datasheets.

We welcome your inquiries regarding pricing, lead time, or other product-related questions.

 [Request a Quote](#)

 [Datasheet Search](#)



Tel: +00 852-30501935

RFQ Email: Info@DiGi-Electronics.com

DiGi is a global authorized distributor of electronic components.

Purchase and inquiry

Manufacturer Product Number:

LSRD-6

Series:

-

Type:

LED

Voltage:

6V

Manufacturer:

IDEC

Product Status:

Active

Color:

-

(Select First, Then Apply Filters) Compatible Series:

IDEC, HW

Environmental & Export classification

Moisture Sensitivity Level (MSL):

Not Applicable



Push-in Switches & Pilot Lights

Simple wiring with Push-in technology



All thoughts focused on the same goal

Since the late 1970s, IDEC has continued to instill and pursue "Save and Safe", as part of our corporate DNA.

Along with the rapid advancement in machine intelligence and demands for environmental resistance and high reliability in recent years, we need to face societal issues such as shortage in workforce.

To solve these issues, we have set as our goals "Safe, Simple & Smart=S3 (S cube)", aiming to provide society with products and services that will bring about greater innovation and lasting quality.

Safe

Products anyone can use with safety and assurance, from a company seeking to be number one in safety

Simple

Products appreciated by all our customers for their ease of connection regardless of experience

Smart

Products that make labor-saving and space-saving a reality

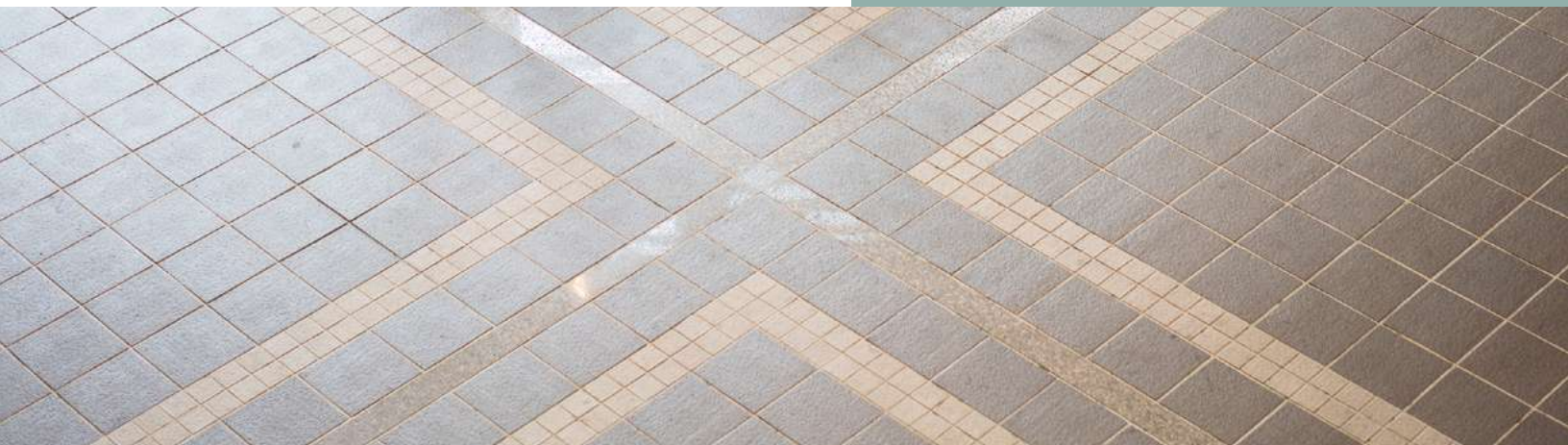

Innovative

We provide easy and user-friendly products with new technology.

First in the industry Six different colors with a single LED

Previously, 5 different color LEDs were required but with the new illuminated LED unit, only a single LED is used. Only the lens needs to be replaced to change the illumination color.

The new LED reduces maintenance time, makes stock control easier, and is environmentally friendly.

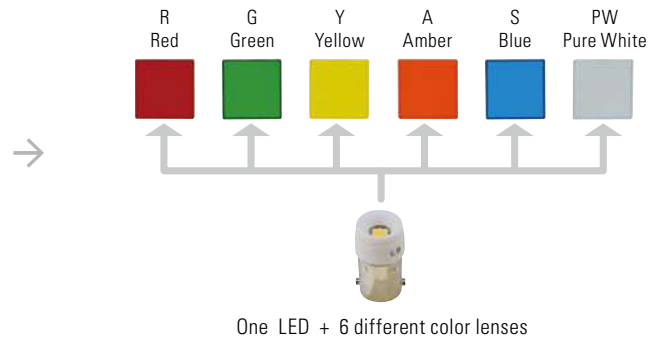
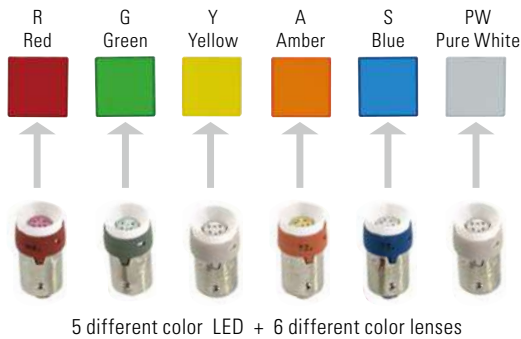

High visibility with new LED

Brighter and clearer compared to conventional LEDs

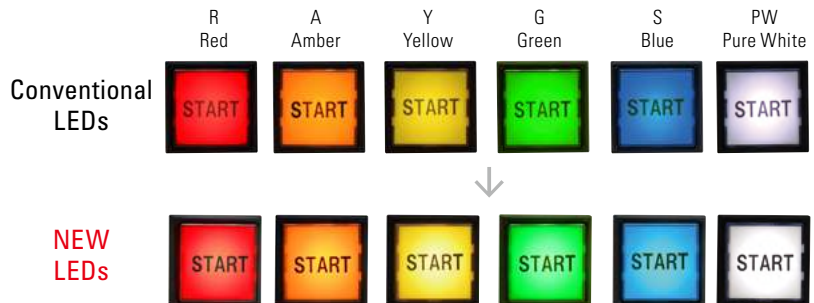

ISO3864-4 Safety color compliant

Safety colors are defined with ISO standards.

The bright and clear colors improve visibility in safety applications.

*Except for products below

- Illuminated selector switches (illumination color: S (Blue), PW (Pure white))
- Illuminated pushbuttons (illumination color: S (Blue))

Push-in

Smart

Simple

Simple wiring for greater work efficiency

Ferrules and solid wires can be connected simply by push-in insertion, without a screwdriver. ^(*1)

To remove, a flat-blade screwdriver is inserted in a simple two-action process.

Since wiring can be performed regardless of operators' skill level, wiring time is reduced.

(*1) When connecting stranded wire, insert the wire while holding down the pusher with a flat-blade screwdriver.

Connecting

1

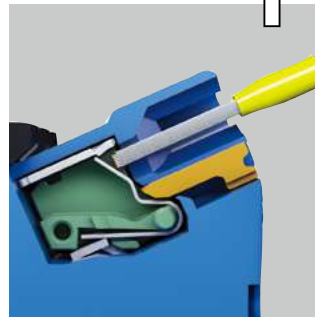

Push the wire straight in as far as it will go.

2



Connection is completed. Pull lightly to make sure it is firmly in place.

Removing

1

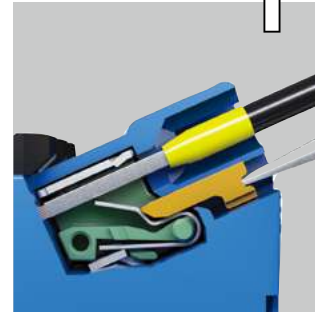

Hold down the pusher with a flat-blade screwdriver.

2

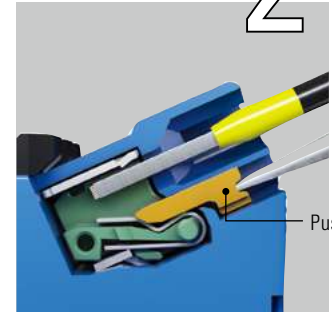

While holding down the pusher, pull out the wire. Release the flat-blade screwdriver.

Smart

Time saving and efficient

Push-in connections are made simple by inserting the wire, reducing wiring time by approximately 55% compared to conventional screw terminals.

[Conditions]

Push-in: Insert wire with ferrule.

Screw terminals: With screw loosened, insert wire, then tighten with electric driver.

Push-in HW Series

Conventional screw terminals

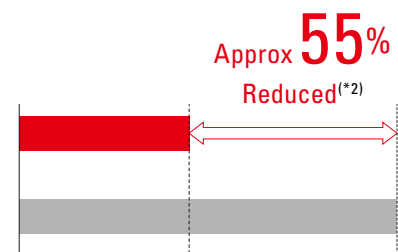

(*2) As of IDEC research (as of January 2020)

Safe

Reliable and easy

Finger-safe structure and vibration resistance.
What's more, the space-saving design means better workability in a smaller space.

Stays firmly in place

Since the ferrule is held in place by a spring load, the wiring remains taut and vibration resistance is improved.

Finger-safe structure

IP20 Finger-safe protection enables wiring to be performed without direct contact between screwdriver and conductive part.

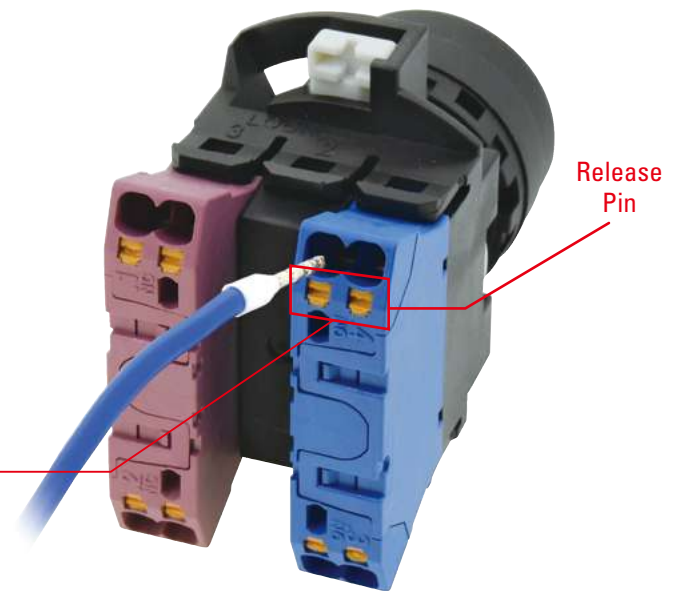

Smart Simple

Wiring procedure comparison

Work can be performed without using tools and regardless of operators' skill level.

*1) When ferrule is used.

Conventional screw terminal



Push-in Terminal ^(*)



Smart

No additional tightening needed

Because screws are not used on push-in terminals, re-tightening of screws is not required.



Product Upgrade

The superior functions of the conventional HW Series still remain while improving ease of use.

Space-Saving Smart

Contact block depth reduced
Saves space inside panel and enables downsizing of equipment.

Pilot light
full voltage type



Conventional HW Series

Panel depth
reduced by
50%
DOWN



Push-in HW Series

Illuminated pushbuttons
6V, 12V, 24V AC/DC



Conventional HW Series

Panel depth
reduced by
30%
DOWN



Push-in HW Series

Illuminated pushbuttons
100/120V AC/DC, 200/220V AC, 230/240V AC



Conventional HW Series

Panel depth
reduced by
40%
DOWN



Push-in HW Series

No transformers required for high voltage types

Smart Smart

High-voltage pilot lights
No transformer required

Applicable for a wide range of voltage (100/120V AC/DC, 200/240V AC). Mounts directly on control and power panels without transformers. Ideal for use in Europe and north America for applications requiring high voltage.



Locking lever

Usability improved by easy mounting and removal. The mounting status of the contact blocks can be confirmed at a glance from the back of the switch.

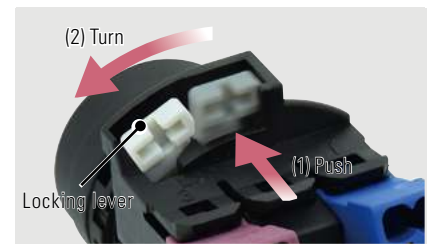

The specifications are the same as the conventional series, enabling easy installation

Panel design
Push-in design does not change the panel design.

Electrical rating and durability
Same electrical ratings and durability with push-in terminal contact blocks.

4-contact configuration available with double contact blocks

Double contact blocks available for all models including emergency stop switches, selector switches, key selector switches.



High voltage LED illuminated unit for illuminated pushbuttons

100/120V AC/DC, 200/220V AC, 230/240V AC types available. No transformers required and same depth behind the panel for all illuminated voltages.

High voltage models do not require transformers enabling downsizing of equipment and panels.

1-contact types also available.

Conventional screw terminal

Push-in

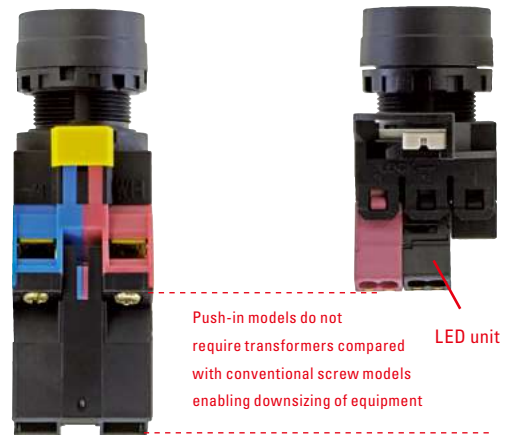

100/120V AC/DC, 200/220V AC, 230/240V AC types

Angled connections

Angled connections make wiring easy even when switches are mounted on a panel.

Also, 24-degree inclination faced to the panel improves the fit of the wires, and contributes to downsizing of the panel and equipment.

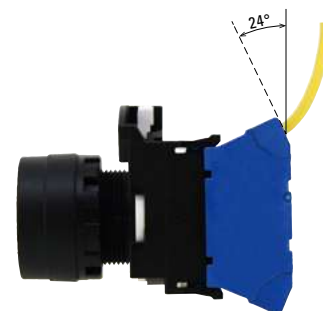



Added Value

Our aim is to create products that enable customers to experience the utmost usability.

Test point

A test point is available to check connectivity of the wiring.
Check the connectivity easily using a multimeter.

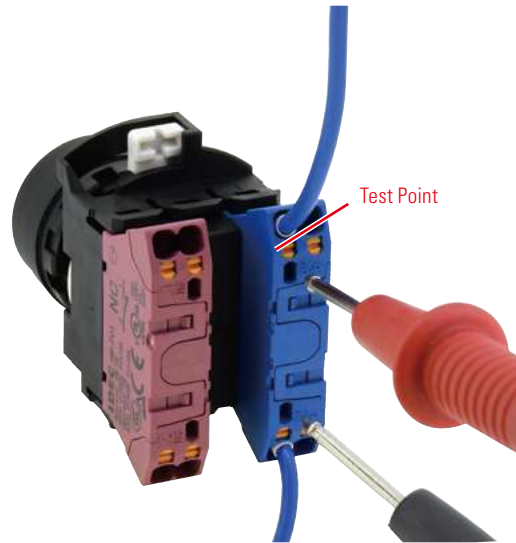

Sub-Assembled Units

Sub-assembled units can be ordered for flexible use, such as unplanned changes in design.



ø22 HW Series Push-in Switches & Pilot Lights

- Push-in terminal connection reduces wiring time.
- Safety enhanced with IP20 finger-safe protection.



File No. E68961

- See website for details on approvals and standards.

Note) Approvals for pushbuttons, selector switches, pilot lights only.

For illuminated/non-illuminated buzzer (page 45) and emergency stop switches (page 46), see each page.

Specifications and Ratings

Contact Ratings

Pushbuttons Illuminated Pushbuttons Dual Pushbuttons Selector Switches Key Selector Switches Illuminated Selector Switches Selector Pushbuttons Monolever Switches Emergency Stop Switches	Rated insulation voltage	600V
	Rated continuous current	10A
	Contact ratings by utilization category IEC60947-5-1	AC-15 (A600) DC-13

- See website for approved contact ratings.

Rated Operating Voltage and Current by Utilization Category

HW-P10 (NO contact), HW-P01 (NC contact), HW-PW20 (2NO contact), HW-PW11 (1NO-1NC contact), HW-PW02 (2NC contact)

Operating Voltage			24V	48V	50V	110V	220V	440V
Operating Current	AC 50/60 Hz	AC-12 Control of resistive loads and solid state loads	10A	-	10A	10A	6A	2A
		AC-15 Control of electromagnetic loads (> 72 VA)	10A	-	7A	5A	3A	1A
	DC	DC-12 Control of resistive loads and solid state loads	10A	5A	-	2.2A	1.1A	-
		DC-13 Control of electromagnets	5A	2A	-	1.1A	0.6A	-

- The operating current represents making and breaking currents (IEC 60947-5-1).
- Contact materials: Silver contacts
- Minimum applicable load: 3V AC/DC, 5 mA (applicable range may vary with operating conditions)

Push-in Contact Block (HW-P..)

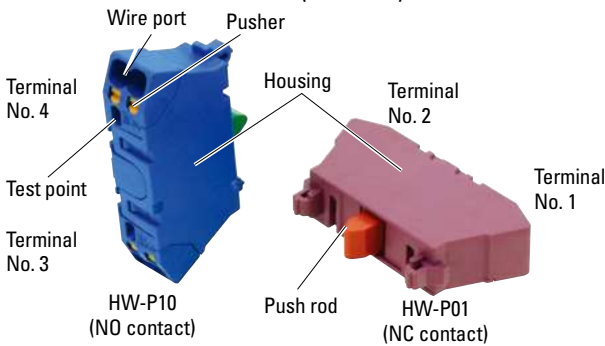

Contact	Single Contact Block		Double Contact Block		
	1NO	1NC	2NO	2NC	1NO-1NC
Part No.	HW-P10	HW-P01	HW-PW20	HW-PW02	HW-PW11
Shape					
Housing	Blue	Purple red	Blue	Purple red	Blue/Purple red
Push Rod	Green	Red	Green	Red	Light Blue
Contact No.	3-4	1-2	1st deck: 13-14 2nd deck: 23-24	1st deck: 11-12 2nd deck: 21-22	1st deck: 13-14 2nd deck: 21-22
Weight	8g		16g		

LED Illuminated Part Specifications

Illuminated Pushbuttons, Illuminated Selector Switches, Dual Pushbuttons (with pilot light)

Rated Voltage	Operating Voltage		LED Lamp	
			Ramp Base	Part No.
6V AC/DC	6V AC/DC	±10%	BA9S/13	LSRD-6
12V AC/DC	12V AC/DC			LSRD-1
24V AC/DC	24V AC/DC			LSRD-2
100/120V AC/DC	100/120V AC/DC			LSRD-H2
200/220V AC	200/220V AC			LSRD-M2
230/240V AC	230/240V AC	207-250V		LSRD-M4

Pilot Light (Short Body)

Rated Voltage		Operating Voltage		LED Lamp	
				Ramp Base	Part No.
6V AC/DC		6V AC/DC	±10%	BA9S/13	LSRD-6
12V AC/DC		12V AC/DC			LSRD-1
24V AC/DC		24V AC/DC			LSRD-2
100/120V AC	50/60Hz	100/120V AC			LSRD-6
200/240V AC		200/240V AC			

LED Lamp Ratings

Part No.	LSRD-6	LSRD-1	LSRD-2	LSRD-H2	LSRD-M2	LSRD-M4
Ramp Base	BA9S/13					
Rated Voltage	6V AC/DC	12V AC/DC	24V AC/DC	100/120V AC/DC	200/220V AC	230/240V AC
Voltage Range	6V AC/DC ±10%	12V AC/DC ±10%	24V AC/DC ±10%	100/120V AC/DC ±10%	200/220V AC ±10%	230/240V AC ±10%
Current Draw	DC	10mA	7mA	7mA	2mA	2mA
	AC	14mA	8mA	8mA	2mA	2mA
Life (reference value)	Approx. 50,000 hours (The luminance is reduced to 50% the initial intensity when used on complete DC at 25°C.)					
Internal Circuit						

Direct Opening of Key Selector Switch

Applicable Type	2-position	3-position
Minimum Operator Angle for Direct Opening Action	60° (90° Maintained)	45°
Minimum Operator Torque for Direct Opening Action	0.4 N·m	
Maximum Operator Angle	60° (90° Maintained)	45°

Degree of Protection

IEC60529

Unit	IEC 60529
All models except illuminated selector switches, dual pushbuttons, pilot lights	IP65 (*1)
Illuminated selectors, pilot lights	IP65
Dual pushbuttons	IP40 (*2)

*1) When using a nameplate with the HW series, IP65 protection degree is achieved only when nameplates shown on page 50 are used. (IP40 when other ø22 nameplates such as NWA are used)

*2) IP65 when used with button covers (HW9Z-D7D).

UL50

Unit	UL50
All models except illuminated selector switches	Type 4X (*3)(*4)

*3) When using a nameplate with the HW series, IP65 protection degree is achieved only when nameplates shown on page 50 are used.

*4) For dual pushbuttons, Type 4X is achieved when used with button covers (HW9Z-D7D).

Specifications

Switches (except for emergency stop switch)

Operating Temperature	-25 to +60°C (no freezing) Illuminated unit: -25 to +50°C
Operating Humidity	45 to 85% RH (no condensation)
Storage Temperature	-40 to +80°C (no freezing)
Contact Resistance	50 mΩ maximum (initial value)
Insulation Resistance	100 MΩ minimum (500V DC megger)
Overvoltage Category	II
Impulse Withstand Voltage	4.0kV Illuminated unit: 2.5kV
Pollution Degree	3 (IEC60947-5-1)
Dielectric Strength	Between live and dead parts: 2500V AC, 1 minute
Vibration Resistance	Damage limits: 30 Hz, amplitude 1.5 mm Operating extremes: 5 to 55Hz, amplitude 0.5 mm
Shock Resistance	Damage limits: 1,000 m/s ² Operating extremes: 100 m/s ²
Degree of Protection	Terminal: Finger-safe (IP20) structure Panel front: IP65 (IEC 60529), UL Type 4X
Recommended Tightening Torque for Locking Ring	2.0N·m
Terminal Style	Push-in terminal
Mechanical Life (minimum operations)	Pushbuttons, Illuminated Pushbuttons
	Momentary 5,000,000 (*5)
	Maintained 1,000,000 (*6)
	Dual pushbuttons 500,000 (*5)
	Selector switches 100,000 (*6)
	Key selector switches (Disc tumbler) 500,000 (*5)
	Key selector switches (Pin tumbler) 100,000 (*6)
	Illuminated selector switches 100,000 (*5)
	Selector pushbuttons 500,000 (*5)
	Monolever switches 100,000 (*6)
	Illuminated selector switches 250,000 (*5)
	Selector pushbuttons 100,000 (*6)
	Monolever switches 250,000 (*5)
	Illuminated selector switches 100,000 (*6)
	Electrical Life (*5)
Momentary 500,000 (*1)(*5)	
Maintained 50,000 (*1)(*6)	
Dual pushbuttons 500,000 (*3)(*5)	
Selector switches 50,000 (*3)(*6)	
Key selector switches 500,000 (*1)(*5)	
Key selector switches (Disc tumbler) 50,000 (*1)(*6)	
Key selector switches (Pin tumbler) 500,000 (*2)(*5)	
Illuminated selector switches 50,000 (*2)(*6)	
Selector pushbuttons 100,000 (*2)(*5)	
Monolever switches 50,000 (*2)(*6)	
Illuminated selector switches 500,000 (*2)(*5)	
Selector pushbuttons 50,000 (*2)(*6)	
Monolever switches 250,000 (*2)(*5)	
Illuminated selector switches 50,000 (*2)(*6)	
Weight (approx.)	38g (HW1B-M1P11), 54g (HW1B-M1P22)
	38g (HW1S-2TP11), 54g (HW1S-2TP22)
	76g (HW1K-2AP11), 92g (HW1K-2AP22N2)
	66g (HW1K-2PCP11), 45g (HW1L-M1P11Q4)
	44g (HW1F-2P11Q4), 43g (HW1R-2AP11)
55g (HW1M-1010P-20), 45g (HW7D-B11P1001)	

*1) Switching frequency 1,800 operations/h, duty ratio 40%

*2) Switching frequency 1,200 operations/h, duty ratio 40%

*3) Switching frequency 900 operations/h, duty ratio 40%

*4) Load condition 220V AC, 3A (AC-15)

*5) Single contact block

*6) Double contact block

Pilot lights

Operating Temperature	-25 to +50°C (no freezing)
Operating Humidity	45 to 85% RH (no condensation)
Storage Temperature	-40 to +80°C (no freezing)
Insulation Resistance	100 MΩ minimum (500V DC megger)
Overvoltage Category	II
Impulse Withstand Voltage	2.5kV
Pollution Degree	3
Dielectric Strength	Between live and dead parts: 2000V AC, 1 minute
Vibration Resistance	Damage limits: 30 Hz, amplitude 1.5 mm Operating extremes: 5 to 55Hz, amplitude 0.5 mm
Shock Resistance	Damage limits: 1,000 m/s ² Operating extremes: 100 m/s ²
Degree of Protection	Terminal: Finger-safe (IP20) structure Panel front: IP65 (IEC 60529), UL Type 4X
Recommended Tightening Torque for Locking Ring	2.0N·m
Terminal Style	Push-in terminal
Weight (approx.)	26g (HW1P-2JPCQ4) 27g (HW1P-2JPRH2) 28g (HW1P-2JPCM2)

Mounting Hole Layout

(Dimensions in mm)

Panel Cut (IEC60947-5-1)

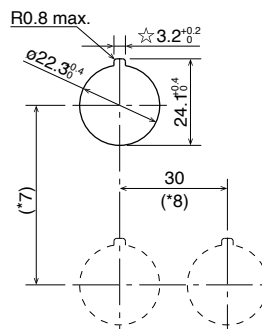

- When high temperature is expected, take necessary measures such as securing sufficient mounting centers or using a cooling fan.
- The 3.2 mm recess is for preventing rotation and is not necessary when the nameplate or anti-rotation ring is not used.

Minimum Mounting Centers

(Dimensions in mm)

Unit	Vertical (*7)	Horizontal (*8)
ø40mm mushroom buttons	50	40
Selector pushbuttons	50	50
Monolever switches	72	72
Pilot lights	50	30
Dual pushbuttons	55	30
Illuminated selector switches	50	50

- For emergency stop switch mounting centers, see page 46.
- Determine the mounting centers in consideration of the operation, wiring, and testing terminals.

Ordering Information

- Specify the Ordering No. when ordering.
When ordering, specify button color, lens color, key removal specification, or key number codes.
- Some combinations cannot be ordered. For details, contact IDEC.
- Nameplates and accessories for mono-lever switch are ordered separately.
See page 50 to 55.

Illuminated / non-illuminated buzzer specifications: see page 45



Emergency stop switch specifications: see page 46

Pushbuttons

Assembled



Package Quantity: 1

Name / Shape	Operation	Contact Configuration	Part No. Coded	⑤ Color Code
Flush HW1B-M1 / HW1B-A1  HW1B-A1 / HW4B-A1	Momentary	1NO	HW1B-M1P10⑤ HW4B-M1P10⑤	B (black) G (green) R (red) Y (yellow) S (blue) W (white)
		1NC	HW1B-M1P01⑤ HW4B-M1P01⑤	
		1NO-1NC	HW1B-M1P11⑤ HW4B-M1P11⑤	
		2NO	HW1B-M1P20⑤ HW4B-M1P20⑤	
		2NC	HW1B-M1P02⑤ HW4B-M1P02⑤	
		2NO-2NC	HW1B-M1P22⑤ HW4B-M1P22⑤	
Extended HW1B-M2 / HW4B-M2 	Momentary	1NO	HW1B-M2P10⑤ HW4B-M2P10⑤	
		1NC	HW1B-M2P01⑤ HW4B-M2P01⑤	
		1NO-1NC	HW1B-M2P11⑤ HW4B-M2P11⑤	

Package Quantity: 1

Name / Shape	Operation	Contact Configuration	Part No. Coded	⑤ Color Code
ø60mm Mushroom HW1B-M5 	Momentary	1NO	HW1B-M5P10⑤	B (black) G (green) R (red) Y (yellow) S (blue) * W (white) *
		1NC	HW1B-M5P01⑤	
ø40mm Mushroom HW1B-M4 / HW4B-M4	Momentary	1NO	HW1B-M4P10⑤ HW4B-M4P10⑤	* Not available for ø60mm
		1NC	HW1B-M4P01⑤ HW4B-M4P01⑤	
		1NC-1NC	HW1B-M4P11⑤ HW4B-M4P11⑤	

- Specify a button color code in place of ⑤ in the Part No.
- Pushbuttons with 1 contact block contain 2 dummy blocks. Pushbuttons with 2 contact blocks contain 1 dummy block.
- When requiring flush type maintained switches other than 1NO contact configuration, select from sub-assembled product.

• For other configurations, select from sub-assembled units (page 13 to 14).

Pushbuttons Part No. Example

Assembled and sub-assembled unit

Assembled

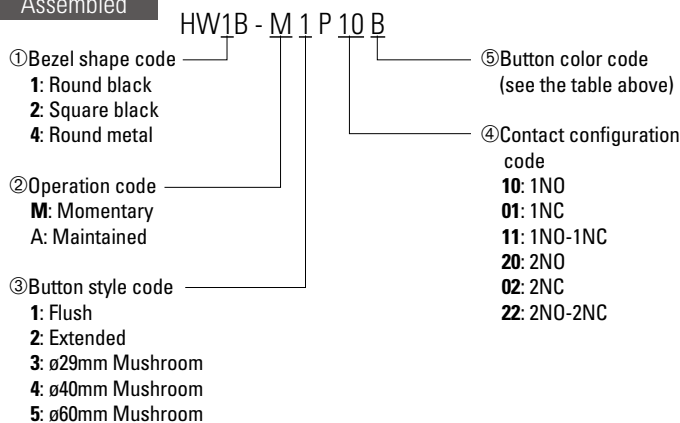

• For available assembled products, see above table.

Operator unit

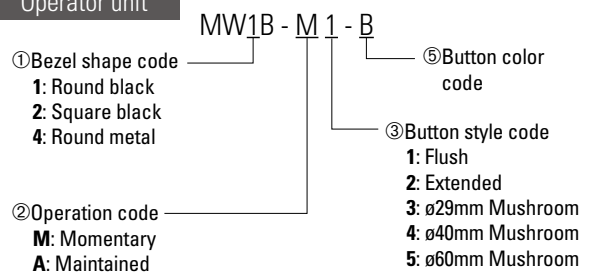

Contact unit

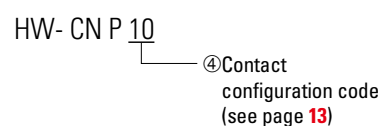

Pushbuttons

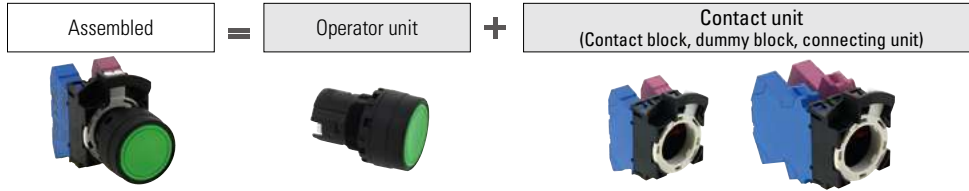

Sub-Assembled

When ordering, specify the sub-assembled ordering no. See page 12 for available assembled products.



Sub-Assembled Ordering No.

Package Quantity: 1

Name / Shape	Operation	Contact Configuration	<Reference> Assembled Part No. ① = 1 or 4	Ⓢ Button Color Code
	Momentary	1NO	HW①B-M1P10⑤	B (black) G (green) R (red) Y (yellow) S (blue) W (white)
		1NC	HW①B-M1P01⑤	
		1NO-1NC	HW①B-M1P11⑤	
		2NO	HW①B-M1P20⑤	
		2NC	HW①B-M1P02⑤	
		2NO-2NC	HW①B-M1P22⑤	
	Maintained	1NO	HW①B-A1P10⑤	
		1NC	HW①B-A1P01⑤	
		1NO-1NC	HW①B-A1P11⑤	
		2NO	HW①B-A1P20⑤	
		2NC	HW①B-A1P02⑤	
		2NO-2NC	HW①B-A1P22⑤	
	Momentary	1NO	HW①B-M2P10⑤	B (black) G (green) R (red) Y (yellow) S (blue) W (white)
		1NC	HW①B-M2P01⑤	
		1NO-1NC	HW①B-M2P11⑤	
		2NO	HW①B-M2P20⑤	
		2NC	HW①B-M2P02⑤	
		2NO-2NC	HW①B-M2P22⑤	
	Maintained	1NO	HW①B-A2P10⑤	
		1NC	HW①B-A2P01⑤	
		1NO-1NC	HW①B-A2P11⑤	
		2NO	HW①B-A2P20⑤	
		2NC	HW①B-A2P02⑤	
		2NO-2NC	HW①B-A2P22⑤	
	Momentary	1NO	HW①B-M3P10⑤	B (black) G (green) R (red) Y (yellow) S (blue) W (white)
		1NC	HW①B-M3P01⑤	
		1NO-1NC	HW①B-M3P11⑤	
		2NO	HW①B-M3P20⑤	
		2NC	HW①B-M3P02⑤	
		2NO-2NC	HW①B-M3P22⑤	
	Maintained	1NO	HW①B-A3P10⑤	
		1NC	HW①B-A3P01⑤	
		1NO-1NC	HW①B-A3P11⑤	
		2NO	HW①B-A3P20⑤	
		2NC	HW①B-A3P02⑤	
		2NO-2NC	HW①B-A3P22⑤	

Operator Unit	
Name / Shape	Part No.
	HW①B-M1-⑤
	HW①B-A1-⑤
	HW①B-M2-⑤
	HW①B-A2-⑤
	HW①B-M3-⑤
	HW①B-A3-⑤

Contact Unit		
Shape	Contact Configuration	Part No. (Ordering No.)
	1NO	HW-CNP10
	1NC	HW-CNP01
	1NO-1NC	HW-CNP11
	2NO	HW-CNP20
	2NC	HW-CNP02
	2NO-2NC	HW-CNP22
	1NO	HW-CNP10
	1NC	HW-CNP01
	1NO-1NC	HW-CNP11
	2NO	HW-CNP20
	2NC	HW-CNP02
	2NO-2NC	HW-CNP22
	1NO	HW-CNP10
	1NC	HW-CNP01
	1NO-1NC	HW-CNP11
	2NO	HW-CNP20
	2NC	HW-CNP02
	2NO-2NC	HW-CNP22

- Specify a bezel type code in place of ① in the Part No. See page 12.
- Specify a button color code in place of Ⓢ in the Part No.
B (black), G (green), R (red), Y (yellow), S (blue), W (white)

For Part No. (Ordering No.)/ mounting positions of contact units, see page 51.





Pushbuttons

Sub-Assembled

When ordering, specify the sub-assembled ordering no. See page 12 for available assembled products.

Sub-Assembled Ordering No.

Package Quantity: 1

Name / Shape	Operation	Contact Configuration	<Reference> Assembled Part No. ① = 1 or 4	⑤ Button Color Code
 ø40mm Mushroom	Momentary	1NO	HW①B-M4P10⑤	B (black) G (green) R (red) Y (yellow) S (blue) W (white)
		1NC	HW①B-M4P01⑤	
		1NO-1NC	HW①B-M4P11⑤	
		2NO	HW①B-M4P20⑤	
		2NC	HW①B-M4P02⑤	
		2NO-2NC	HW①B-M4P22⑤	
	Maintained	1NO	HW①B-A4P10⑤	
		1NC	HW①B-A4P01⑤	
		1NO-1NC	HW①B-A4P11⑤	
		2NO	HW①B-A4P20⑤	
		2NC	HW①B-A4P02⑤	
		2NO-2NC	HW①B-A4P22⑤	
 ø60mm Mushroom	Momentary	1NO	HW1B-M5P10⑤	B (black) G (green) R (red) Y (yellow)
		1NC	HW1B-M5P01⑤	
		1NO-1NC	HW1B-M5P11⑤	
		2NO	HW1B-M5P20⑤	
		2NC	HW1B-M5P02⑤	
		2NO-2NC	HW1B-M5P22⑤	
		 Square Flush	Momentary	
1NC	HW2B-M1P01⑤			
1NO-1NC	HW2B-M1P11⑤			
2NO	HW2B-M1P20⑤			
2NC	HW2B-M1P02⑤			
2NO-2NC	HW2B-M1P22⑤			
Maintained	1NO		HW2B-A1P10⑤	
	1NC		HW2B-A1P01⑤	
	1NO-1NC		HW2B-A1P11⑤	
	2NO		HW2B-A1P20⑤	
	2NC		HW2B-A1P02⑤	
	2NO-2NC		HW2B-A1P22⑤	
 Square Extended	Momentary	1NO	HW2B-M2P10⑤	B (black) G (green) R (red) Y (yellow) S (blue) W (white)
		1NC	HW2B-M2P01⑤	
		1NO-1NC	HW2B-M2P11⑤	
		2NO	HW2B-M2P20⑤	
		2NC	HW2B-M2P02⑤	
		2NO-2NC	HW2B-M2P22⑤	
	Maintained	1NO	HW2B-A2P10⑤	
		1NC	HW2B-A2P01⑤	
		1NO-1NC	HW2B-A2P11⑤	
		2NO	HW2B-A2P20⑤	
		2NC	HW2B-A2P02⑤	
		2NO-2NC	HW2B-A2P22⑤	

Operator Unit	
Name / Shape	Part No.
 ø40mm Mushroom	HW①B-M4-⑤
	HW①B-A4-⑤
 ø60mm Mushroom	HW1B-M5-⑤ (*1)
 Square Flush	HW2B-M1-⑤
	HW2B-A1-⑤
 Square Extended	HW2B-M2-⑤
	HW2B-A2-⑤

Contact Unit		
Shape	Contact Configuration	Part No. (Ordering No.)
	1NO	HW-CNP10
	1NC	HW-CNP01
	1NO-1NC	HW-CNP11
	2NO	HW-CNP20
	2NC	HW-CNP02
	2NO-2NC	HW-CNP22
	1NO	HW-CNP10
	1NC	HW-CNP01
	1NO-1NC	HW-CNP11
	2NO	HW-CNP20
	2NC	HW-CNP02
	2NO-2NC	HW-CNP22
	1NO	HW-CNP10
	1NC	HW-CNP01
	1NO-1NC	HW-CNP11
	2NO	HW-CNP20
	2NC	HW-CNP02
	2NO-2NC	HW-CNP22
	1NO	HW-CNP10
	1NC	HW-CNP01
	1NO-1NC	HW-CNP11
	2NO	HW-CNP20
	2NC	HW-CNP02
	2NO-2NC	HW-CNP22

• Specify a bezel type code in place of ① in the Part No. See page 12.

• Specify a button color code in place of ⑤ in the Part No.
 B (black), G (green), R (red), Y (yellow), S (blue), W (white)

*1) Only B (black), G (green), R (red), Y (yellow) available for ø60mm mushroom.

The anti-rotation ring P/N: HW9Z-RL is **not** included with the operator and can be purchased separately.

For Part No. (Ordering No.) / mounting positions of contact units, see page 51.

Pushbuttons Dimensions

All dimensions in mm.

Flush

1 to 2 contacts
HW1B-□1P

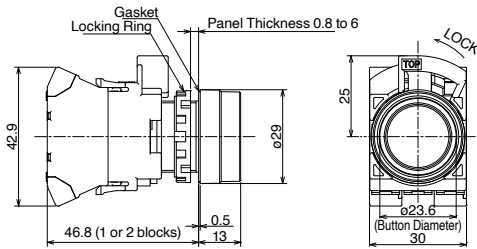

3 to 4 contacts
HW1B-□1P

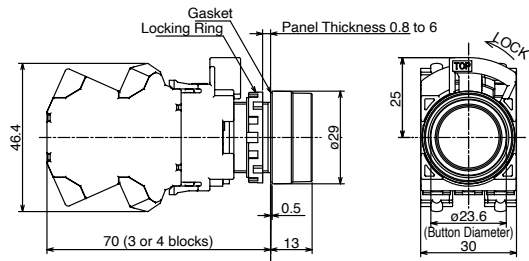

Extended

1 to 2 contacts
HW1B-□2P

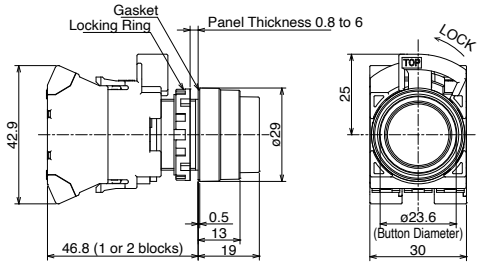

3 to 4 contacts
HW1B-□2P

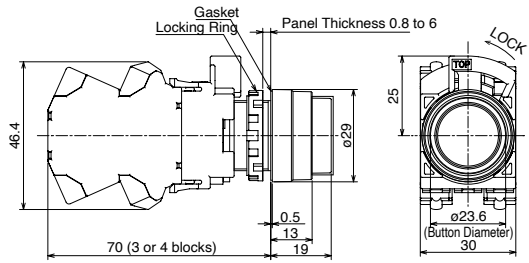

ø29mm Mushroom

1 to 2 contacts
HW1B-□3P

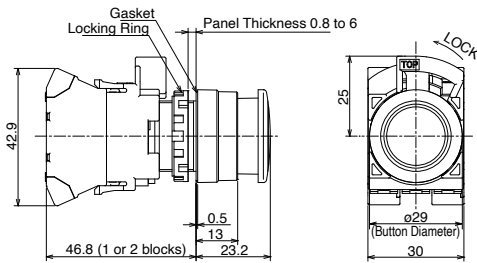

3 to 4 contacts
HW1B-□3P

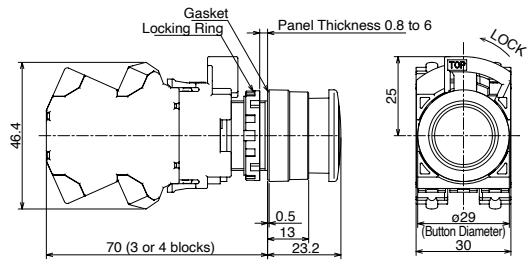

ø40mm Mushroom

1 to 2 contacts
HW1B-□4P

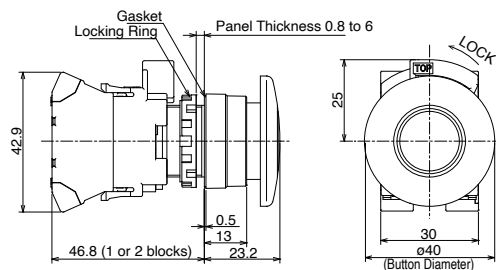

3 to 4 contacts
HW1B-□4P

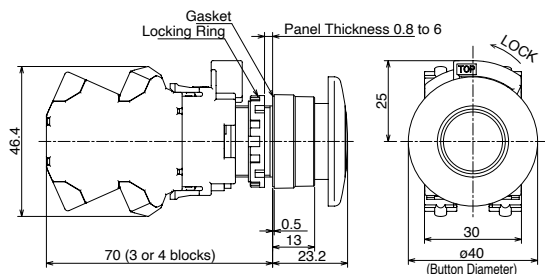

Pushbuttons Dimensions

All dimensions in mm.

ø60mm Mushroom

1 to 2 contacts
HW1B-M5P

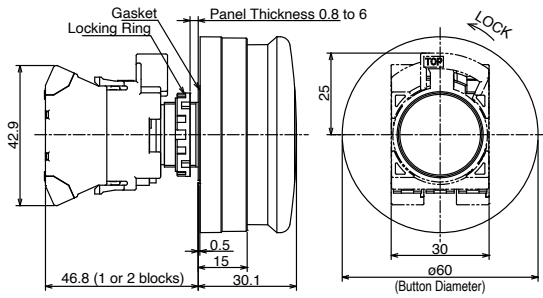

3 to 4 contacts
HW1B-M5P

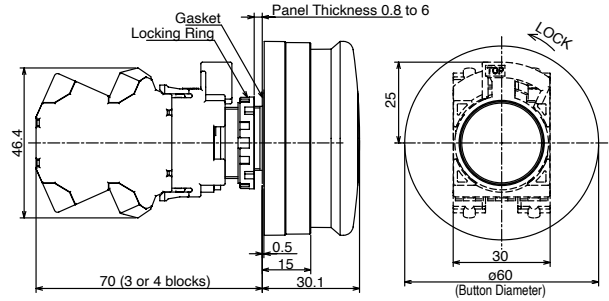

Square Flush

1 to 2 contacts
HW2B-□1P

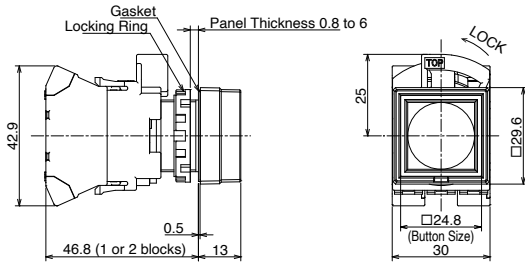

3 to 4 contacts
HW2B-□1P

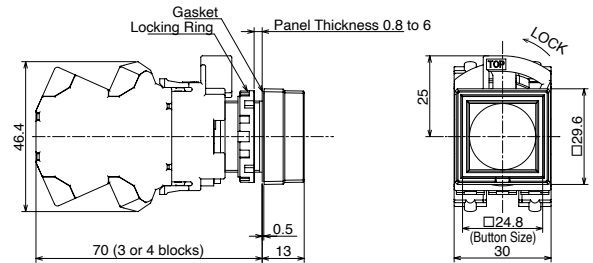

Square Extended

1 to 2 contacts
HW2B-□2P

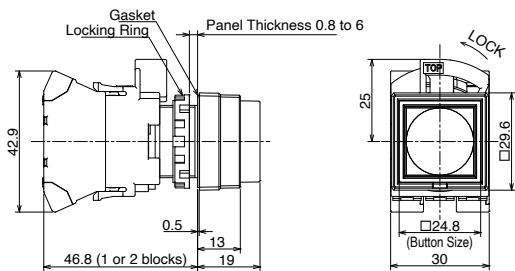

3 to 4 contacts
HW2B-□2P

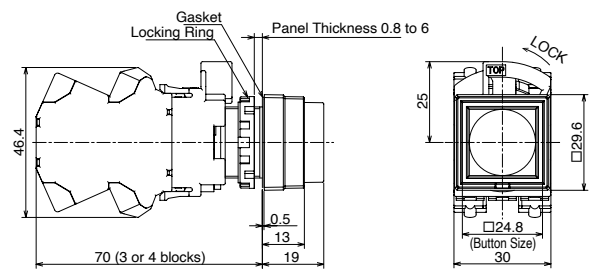

Illuminated Pushbuttons

Assembled



Package Quantity: 1

Name / Shape	Operation	Rated Voltage	Contact Configuration	Part No. (coded) ① = 1 or 4	⑥ Illumination Color Code
Round Flush (marking) HW1L-M1 HW1L-A1 HW4L-M1 HW4L-A1 	Momentary	24V AC/DC	1NO	HW①L-M1P10Q4⑥	R (red) G (green) Y (yellow) A (amber) S (blue) PW (pure white)
			1NO-1NC	HW①L-M1P11Q4⑥	
		100/120V AC/DC	1NO	HW①L-M1P10QH2⑥	
	Maintained	24V AC/DC	1NO	HW①L-A1P10Q4⑥	
			1NO-1NC	HW①L-A1P11Q4⑥	
			2NO	HW①L-A1P20Q4⑥	
Round Extended (marking) HW1L-M2 / HW4L-M2 	Momentary	24V AC/DC	1NO	HW①L-M2P10Q4⑥	R (red) G (green) Y (yellow) A (amber) S (blue) PW (pure white)
			1NO-1NC	HW①L-M2P11Q4⑥	
Round Extended with Full Shroud (marking) HW1L-MF2 	Momentary	24V AC/DC	1NO	HW①L-MF2P10Q4⑥	R (red) G (green) Y (yellow) A (amber) S (blue) PW (pure white)
		100/120V AC/DC	1NO	HW①L-MF2P10QH2⑥	
Square Flush (marking) HW2L-M1 	Momentary	24V AC/DC	1NO	HW2L-M1P10Q4⑥	R (red) G (green) Y (yellow) A (amber) S (blue) PW (pure white)
			1NO-1NC	HW2L-M1P11Q4⑥	

- Specify a bezel type code in place of ① in the Part No. See page 12.
- Specify an illumination color code in place of ⑥ in the Part No.

• For other configurations, select from sub-assembled units (page 18 to 19).

Illuminated Pushbuttons

Sub-Assembled

When ordering, specify the sub-assembled ordering no. See page 17 for available assembled products.

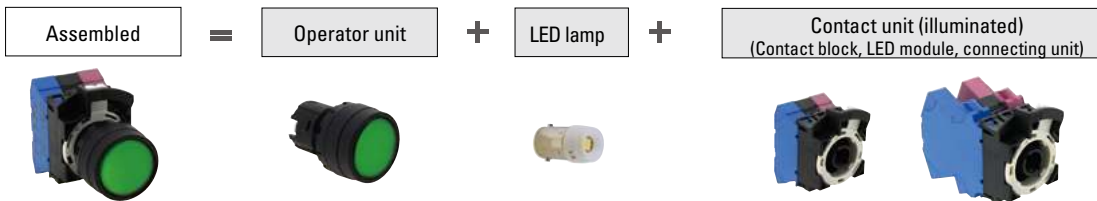

Sub-Assembled Ordering No.

Package Quantity: 1

Name / Shape	Operation	Contact Configuration	<Reference> Assembled Part No. ① = 1 or 4	⑥ Illumination Color Code
	Momentary	1NO	HW①L-M1P10⑤⑥	R (red) G (green) Y (yellow) A (amber) S (blue) PW (pure white)
		1NC	HW①L-M1P01⑤⑥	
		1NO-1NC	HW①L-M1P11⑤⑥	
		2NO	HW①L-M1P20⑤⑥	
	Maintained	2NC	HW①L-M1P02⑤⑥	
		2NO-2NC	HW①L-M1P22⑤⑥	
		1NO	HW①L-A1P10⑤⑥	
		1NC	HW①L-A1P01⑤⑥	
		1NO-1NC	HW①L-A1P11⑤⑥	
		2NO	HW①L-A1P20⑤⑥	
		2NC	HW①L-A1P02⑤⑥	
		2NO-2NC	HW①L-A1P22⑤⑥	
	Momentary	1NO	HW①L-M2P10⑤⑥	R (red) G (green) Y (yellow) A (amber) S (blue) PW (pure white)
		1NC	HW①L-M2P01⑤⑥	
		1NO-1NC	HW①L-M2P11⑤⑥	
		2NO	HW①L-M2P20⑤⑥	
	Maintained	2NC	HW①L-M2P02⑤⑥	
		2NO-2NC	HW①L-M2P22⑤⑥	
		1NO	HW①L-A2P10⑤⑥	
		1NC	HW①L-A2P01⑤⑥	
		1NO-1NC	HW①L-A2P11⑤⑥	
		2NO	HW①L-A2P20⑤⑥	
		2NC	HW①L-A2P02⑤⑥	
		2NO-2NC	HW①L-A2P22⑤⑥	
	Momentary	1NO	HW①L-MF2P10⑤⑥	R (red) G (green) Y (yellow) A (amber) S (blue) PW (pure white)
		1NC	HW①L-MF2P01⑤⑥	
		1NO-1NC	HW①L-MF2P11⑤⑥	
		2NO	HW①L-MF2P20⑤⑥	
	Maintained	2NC	HW①L-MF2P02⑤⑥	
		2NO-2NC	HW①L-MF2P22⑤⑥	
		1NO	HW①L-AF2P10⑤⑥	
		1NC	HW①L-AF2P01⑤⑥	
		1NO-1NC	HW①L-AF2P11⑤⑥	
		2NO	HW①L-AF2P20⑤⑥	
		2NC	HW①L-AF2P02⑤⑥	
		2NO-2NC	HW①L-AF2P22⑤⑥	

Operator unit	
Name / Shape	<Reference> Assembled Part No. ① = 1 or 4
	HW①L-M1⑥-PI-USA
	HW①L-M2⑥-PI-USA
	HW①L-MF2⑥-PI-USA
	HW①L-AF2⑥-PI-USA

Contact Unit		
Shape	Contact Configuration	Part No. (Ordering No.)
	1NO	HW-CNP100Q
	1NC	HW-CNP010Q
	1NO-1NC	HW-CNP110Q
	2NO	HW-CNP200Q
	2NC	HW-CNP020Q
	2NO-2NC	HW-CNP220Q
	1NO	HW-CNP100Q
	1NC	HW-CNP010Q
	1NO-1NC	HW-CNP110Q
	2NO	HW-CNP200Q
	2NC	HW-CNP020Q
	2NO-2NC	HW-CNP220Q

- Specify a bezel type code in place of ① in the Part No. See page 12.
- Specify a rated voltage code in place of ⑤ in the Part No.

Code	Rated voltage	Code	Rated voltage
Q2	6V AC/DC	QH2	100/120V AC/DC
Q3	12V AC/DC	QM	200/220V AC
Q4	24V AC/DC	QM4	230/240V AC



- Specify an illumination color code in place of ⑥ in the Part No.
R (red), G (green), Y (yellow), A (amber), S (blue), PW (pure white)

Note) LED lamp is not supplied. When ordering contact units (illuminated) selected LED from below table.

LED lamp (package quantity:1)	
Rated Voltage	Part No. (Ordering No.)
6V AC/DC	LSRD-6
12V AC/DC	LSRD-1
24V AC/DC	LSRD-2
100/120V AC/DC	LSRD-H2
200/220V AC	LSRD-M2
230/240V AC	LSRD-M4

For Part No. (Ordering No.)/ mounting positions of contact units, see page 52.



Illuminated Pushbuttons

Name / Shape	Operation	Contact Configuration	<Reference> Assembled Part No. ① = 1 or 4	⑥ Color Code
Square Flush (marking) 	Momentary	1NO	HW2L-M1P10⑤⑥	R (red) G (green) Y (yellow) A (amber) S (blue) PW (pure white)
		1NC	HW2L-M1P01⑤⑥	
		1NO-1NC	HW2L-M1P11⑤⑥	
		2NO	HW2L-M1P20⑤⑥	
		2NC	HW2L-M1P02⑤⑥	
	Maintained	1NO	HW2L-A1P10⑤⑥	
		1NC	HW2L-A1P01⑤⑥	
		1NO-1NC	HW2L-A1P11⑤⑥	
		2NO	HW2L-A1P20⑤⑥	
		2NC	HW2L-A1P02⑤⑥	
ø29 Mushroom (marking) 	Momentary	1NO	HW①L-M3P10⑤⑥	R (red) G (green) Y (yellow) A (amber) S (blue) PW (pure white)
		1NC	HW①L-M3P01⑤⑥	
		1NO-1NC	HW①L-M3P11⑤⑥	
		2NO	HW①L-M3P20⑤⑥	
		2NC	HW①L-M3P02⑤⑥	
	Maintained	1NO	HW①L-A3P10⑤⑥	
		1NC	HW①L-A3P01⑤⑥	
		1NO-1NC	HW①L-A3P11⑤⑥	
		2NO	HW①L-A3P20⑤⑥	
		2NC	HW①L-A3P02⑤⑥	
ø40 Jumbo Mushroom (marking) 	Momentary	1NO	HW①L-M4P10⑤⑥	R (red) G (green) Y (yellow) A (amber) S (blue) PW (pure white)
		1NC	HW①L-M4P01⑤⑥	
		1NO-1NC	HW①L-M4P11⑤⑥	
		2NO	HW①L-M4P20⑤⑥	
		2NC	HW①L-M4P02⑤⑥	
	Maintained	1NO	HW①L-A4P10⑤⑥	
		1NC	HW①L-A4P01⑤⑥	
		1NO-1NC	HW①L-A4P11⑤⑥	
		2NO	HW①L-A4P20⑤⑥	
		2NC	HW①L-A4P02⑤⑥	

Sub-Assembled Ordering No.

Operator unit	
Name / Shape	<Reference> Assembled Part No. ① = 1 or 4
Square Flush (marking) 	HW2L-M1⑥-PI-USA
ø29 Mushroom (marking) 	HW①L-M3⑥-PI-USA
ø40 Jumbo Mushroom (marking) 	HW①L-M4⑥-PI-USA

Package Quantity: 1

Contact Unit		
Shape	Contact Configuration	Part No. (Ordering No.)
	1NO	HW-CNP10Q0
	1NC	HW-CNP01Q0
	1NO-1NC	HW-CNP11Q0
	2NO	HW-CNP20Q0
	2NC	HW-CNP02Q0
	1NO	HW-CNP10Q0
	1NC	HW-CNP01Q0
	1NO-1NC	HW-CNP11Q0
	2NO	HW-CNP20Q0
	2NC	HW-CNP02Q0
	1NO	HW-CNP10Q0
	1NC	HW-CNP01Q0
	1NO-1NC	HW-CNP11Q0
	2NO	HW-CNP20Q0
	2NC	HW-CNP02Q0

- Specify a bezel type code in place of ① in the Part No. See page 12.
- Specify a rated voltage code in place of ⑤ in the Part No.

Code	Rated voltage	Code	Rated voltage
Q2	6V AC/DC	QH2	100/120V AC/DC
Q3	12V AC/DC	QM	200/220V AC
Q4	24V AC/DC	QM4	230/240V AC

- Specify an illumination color code in place of ⑥ in the Part No.
R (red), G (green), Y (yellow), A (amber), S (blue), PW (pure white)

Note) LED lamp is not supplied. When ordering contact units (illuminated) selected LED from below table.

LED lamp (package quantity:1)	
Rated Voltage	Part No. (Ordering No.)
6V AC/DC	LSRD-6
12V AC/DC	LSRD-1
24V AC/DC	LSRD-2
100/120V AC/DC	LSRD-H2
200/220V AC	LSRD-M2
230/240V AC	LSRD-M4

For Part No. (Ordering No.)/ mounting positions of contact units, see page 52.

Illuminated Pushbuttons Dimensions

All dimensions in mm.

Round Flush
1 to 2 contacts
HW1L-□1P

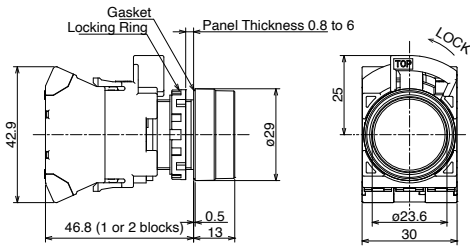

3 to 4 contacts
HW1L-□1P

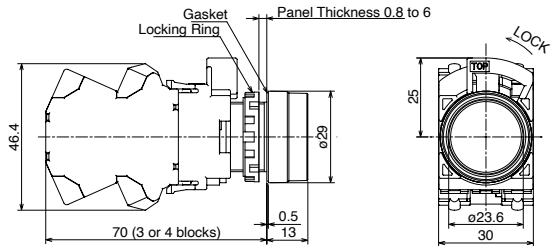

Round Extended
1 to 2 contacts
HW1L-□2P

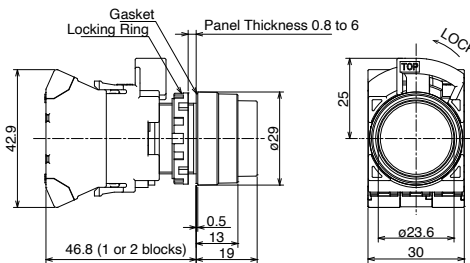

3 to 4 contacts
HW1L-□2P

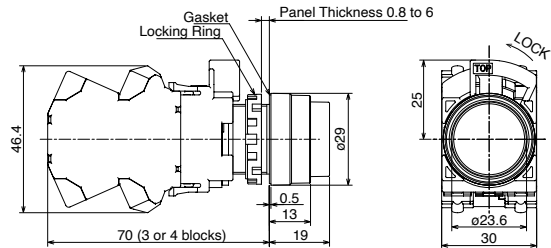

Round Extended with Full Shroud
1 to 2 contacts
HW1L-□F2P

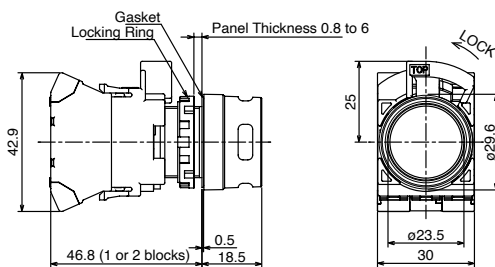

3 to 4 contacts
HW1L-□F2P

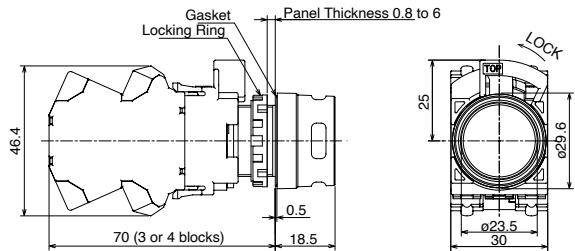

Square Flush
1 to 2 contacts
HW2L-□1P

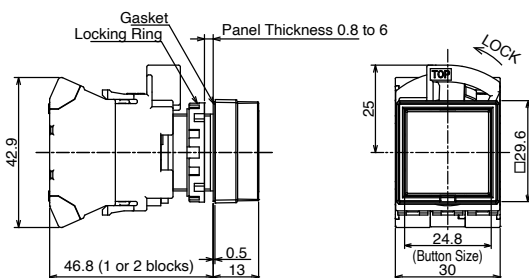

3 to 4 contacts
HW2L-□1P

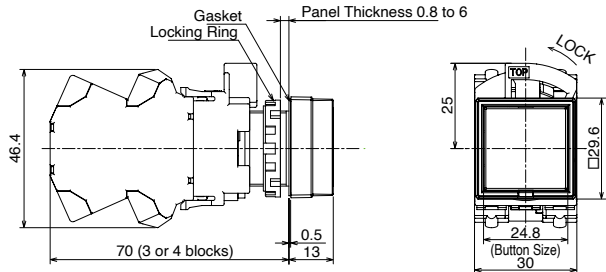

Illuminated Pushbuttons Dimensions

All dimensions in mm.

ø29 Mushroom

1 to 2 contacts
HW1L-□3P

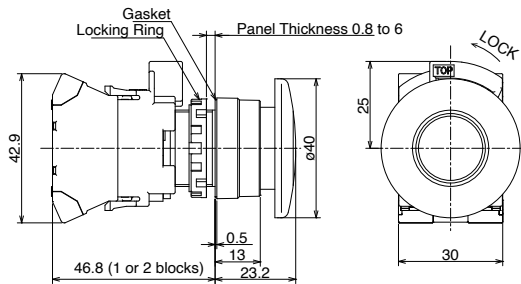

3 to 4 contacts
HW1L-□3P

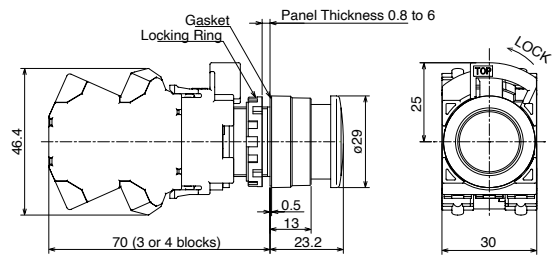

ø40 Jumbo Mushroom

1 to 2 contacts
HW1L-□4P

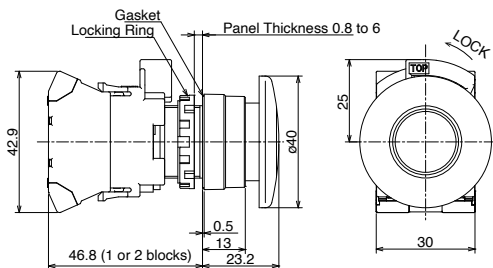

3 to 4 contacts
HW1L-□4P

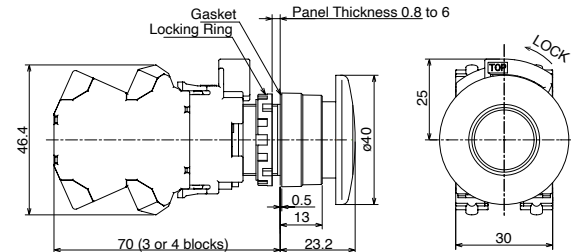

Illuminated Pushbuttons Part No. Example

Assembled and sub-assembled unit

Assembled

HW1L - M 1 P 11 Q4 R

- ① Bezel shape code
1: Round black
2: Square black
4: Round Metal
- ② Operation code
M: Momentary
A: Maintained
- ③ Button style code
1: Flush
2: Extended
F2: Round Extended with full Shroud
3: ø29mm Mushroom
4: ø40mm Mushroom
- ④ Contact configuration code
10: 1NO
01: 1NC
11: 1NO1NC
20: 2NO
02: 2NC
22: 2NO-2NC
- ⑤ Rated voltage code
Q2 : 6V AC/DC
Q3 : 12V AC/DC
Q4 : 24V AC/DC
QH2 : 100/120V AC/DC
QM : 200/220V AC
QM4 : 230/240V AC
- ⑥ Button color code (see page 17)

Operator unit

HW1L - M 1 R - PI-USA

- ① Bezel shape code
1: Round black
2: Square black
4: Round metal
- ② Operation code
M: Momentary
A: Maintained
- ③ Button style code
1: Flush
2: Extended
F2: Round Extended with full Shroud
3: ø29mm Mushroom
4: ø40mm Mushroom
- ⑥ Button color code (see page 18)

Contact unit (illuminated)

HW - CN P 10 Q0

- ④ Contact configuration code (see page 18)

• LED lamps are not supplied.

LED lamp

LSRD - 6

- ⑤ Rated voltage code
6 : 6V AC/DC
1 : 12V AC/DC
2 : 24V AC/DC
H2 : 100/120V AC/DC
M2 : 200/220V AC
M4 : 230/240V AC

• For available assembled products, see table on page 17.

Dual Pushbuttons without Pilot Light

Sub-Assembled

Dual pushbuttons can be purchased only as a sub-assembled product.

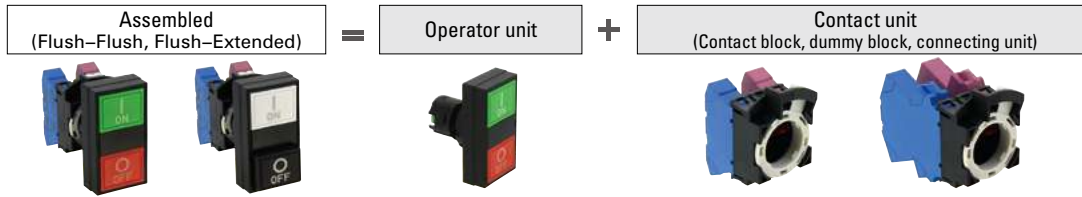





Without Pilot Light

Sub-Assembled Ordering No.

Package Quantity: 1

Operation	Button style	Contact Configuration		<Reference> Assembled Part No
		Top Button	Bottom Button	
		<Reference>		
Momentary	Flush-Flush	1NO	1NC	HW7D-B11P1001⑥⑦
		1NO	1NO	HW7D-B11P1010⑥⑦
		1NO-1NC	1NO-1NC	HW7D-B11P1111⑥⑦
		2NO	2NC	HW7D-B11P2002⑥⑦
	Flush-Extended	1NO	1NC	HW7D-B12P1001⑥⑦
		1NO	1NO	HW7D-B12P1010⑥⑦
Interlocking (*1)	Flush-Flush	1NO	1NC	HW7D-B21P1001⑥⑦
		1NO	1NO	HW7D-B21P1010⑥⑦
		1NO-1NC	1NO-1NC	HW7D-B21P1111⑥⑦
		2NO	2NC	HW7D-B21P2002⑥⑦
	Flush-Extended	1NO	1NC	HW7D-B22P1001⑥⑦
		1NO	1NO	HW7D-B22P1010⑥⑦
		1NO-1NC	1NO-1NC	HW7D-B22P1111⑥⑦
		2NO	2NC	HW7D-B22P2002⑥⑦

Operator Unit Part No. (Ordering No.)
 HW7D-B11⑥⑦
 HW7D-B12⑥⑦
 HW7D-B21⑥⑦
 HW7D-B22⑥⑦

Contact Unit		
Contact Configuration		Part No. (Ordering No.)
Top Button	Bottom Button	
1NO	1NC	HW-CNP11
1NO	1NO	HW-CNP20
1NO-1NC	1NO-1NC	HW-CNP22
2NO	2NC	HW-CNP22N1
1NO	1NC	HW-CNP11
1NO	1NO	HW-CNP20
1NO-1NC	1NO-1NC	HW-CNP22
2NO	2NC	HW-CNP22N1

*1) Interlock: Momentary operation. When one of the buttons is pressed, the other button cannot be operated.

Do not operate top and bottom buttons at the same time. Operating the buttons at the same time may lead to malfunctions.

- For contact mounting position, see page 51.
- Specify a code in place of ⑥⑦ in the Part No. See tables below

⑥Button Color Code

Code	
GR	Top Button Green Bottom Button Red
WB	Top Button White Bottom Button Black

⑦Button Legends Code

Code	
Blank	Blank
1	Top Button: I & ON / Bottom Button: O & OFF

Contact Configuration

Contact Configuration			Contact Block		Top Button		Bottom Button		Button Position Pushbutton Operation
Top Button	Bottom Button	Code	Mounting Position	Contact	Nomal	Push	Nomal	Push	
1NO	1NC	1001	(1)	NO		X			
			(3)	NC			X		
1NO	1NO	1010	(1)	NO		X			
			(3)	NO				X	
1NO-1NC	1NO-1NC	1111	(1)	NONC	NO	X			
			(3)	NONC	NO			X	
2NO	2NC	2002	(1)	2NO	NO	X			
			(3)	2NC	NO	X			
					NC		X		
					NC		X		

Contact Block Mounting Position

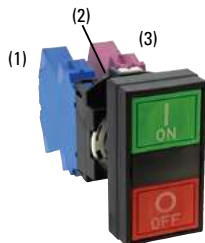

Note) (2) can only be mounted with a dummy block.

Contact block (1) is actuated by the top button.
Contact block (3) is actuated by the bottom button.

For Part No. (Ordering No.)/ mounting positions of contact units, see page 51.

Dual Pushbuttons with Pilot Light

Sub-Assembled

Dual pushbuttons can be purchased only as a sub-assembled product.

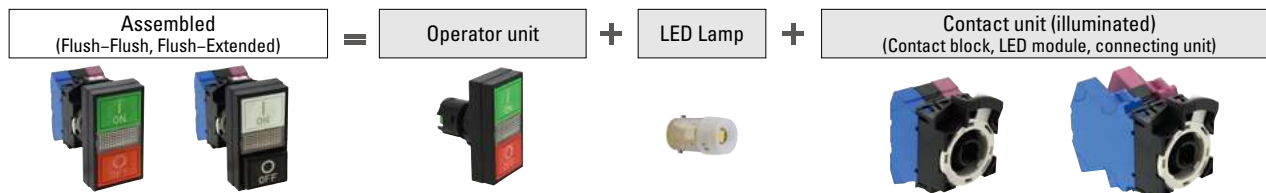

With Pilot Light

Sub-Assembled Ordering No.

Package Quantity: 1

Operation	Button Style	<Reference>		<Reference> Assembled Part No
		Contact Configuration		
		Top Button	Bottom Button	
Momentary	Flush-Flush	1NO	1NC	HW7D-L11P1001PW⑥⑦
		1NO	1NO	HW7D-L11P1010PW⑥⑦
		1NO-1NC	1NO-1NC	HW7D-L11P1111PW⑥⑦
		2NO	2NC	HW7D-L11P2002PW⑥⑦
	Flush-Extended	1NO	1NC	HW7D-L12P1001PW⑥⑦
		1NO	1NO	HW7D-L12P1010PW⑥⑦
		1NO-1NC	1NO-1NC	HW7D-L12P1111PW⑥⑦
		2NO	2NC	HW7D-L12P1010PW⑥⑦
Interlocking (*1)	Flush-Flush	1NO	1NC	HW7D-L21P1001PW⑥⑦
		1NO	1NO	HW7D-L21P1010PW⑥⑦
		1NO-1NC	1NO-1NC	HW7D-L21P1111PW⑥⑦
		2NO	2NC	HW7D-L21P2002PW⑥⑦
	Flush-Extended	1NO	1NC	HW7D-L22P1001PW⑥⑦
		1NO	1NO	HW7D-L22P1010PW⑥⑦
		1NO-1NC	1NO-1NC	HW7D-L22P1111PW⑥⑦
		2NO	2NC	HW7D-L22P2002PW⑥⑦

Operator Unit
Part No. (Ordering No.)
HW7D-L11⑥⑦
HW7D-L12⑥⑦
HW7D-L21⑥⑦
HW7D-L22⑥⑦

Contact Unit		
Contact Configuration		Part No. (Ordering No.)
Top Button	Bottom Button	
1NO	1NC	HW-CNP11Q0
1NO	1NO	HW-CNP20Q0
1NO-1NC	1NO-1NC	HW-CNP22Q0
2NO	2NC	HW-CNP22N1Q0
1NO	1NC	HW-CNP11Q0
1NO	1NO	HW-CNP20Q0
1NO-1NC	1NO-1NC	HW-CNP22Q0
2NO	2NC	HW-CNP22N1Q0

*1) Interlock: Momentary operation. When one of the buttons is pressed, the other button cannot be operated.

- Do not operate top and bottom buttons at the same time. Operating the buttons at the same time may lead to malfunctions.
- For contact mounting position, see page 52.
- Specify a code in place of ⑥⑦ in the Part No. See tables below

Code	Rated Voltage	Code	Rated Voltage
Q2	6V AC/DC	QH2	100/120V AC/DC
Q3	12V AC/DC	QM	200/220V AC
Q4	24V AC/DC	QM4	230/240V AC

⑥Button Color Code

Code	
GR	Top Button Green Bottom Button Red
WB	Top Button White Bottom Button Black

⑦Button Legends Code

Code	
Blank	Blank
1	Top Button: I & ON/ Bottom Button: O & OFF

Note) LED lamp is not supplied. When ordering contact units (illuminated) selected LED from below table.

LED lamp (Package Quantity: 1)	
Rated Voltage	Part No. (Ordering No.)
6V AC/DC	LSRD-6
12V AC/DC	LSRD-1
24V AC/DC	LSRD-2
100/120V AC/DC	LSRD-H2
200/220V AC	LSRD-M2
230/240V AC	LSRD-M4

Contact Block Mounting Position

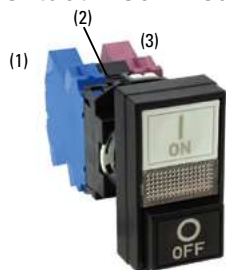

Note) (2) can only be mounted with a full voltage adapter.

For Part No. (Ordering No.)/ mounting positions of contact units, see page 52.

Dual Pushbuttons

Dual Pushbuttons Part No. Example

Assembled and sub-assembled unit

Assembled (without pilot light)

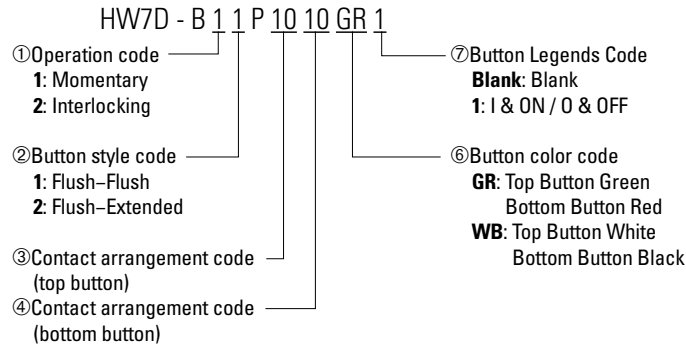

Top button	Bottom button	Contact configuration	
		Top button	Bottom button
1NO	1NC	10	01
1NO	1NO	10	10
1NO-1NC	1NO-1NC	11	11
2NO	2NC	20	02

Assembled (with pilot light)

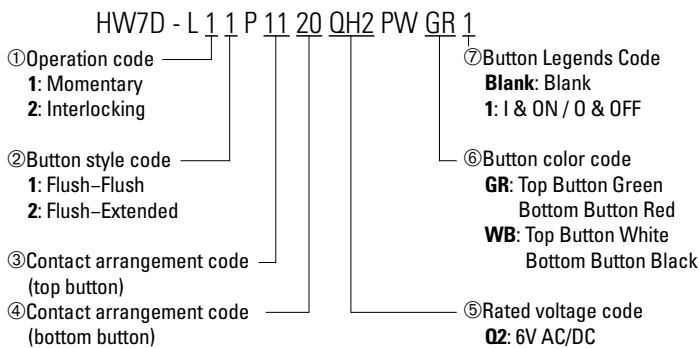

Top button	Bottom button	Contact configuration	
		Top button	Bottom button
1NO	1NC	10	01
1NO	1NO	10	10
1NO-1NC	1NO-1NC	11	11
2NO	2NC	20	02

Operator unit (without pilot light)

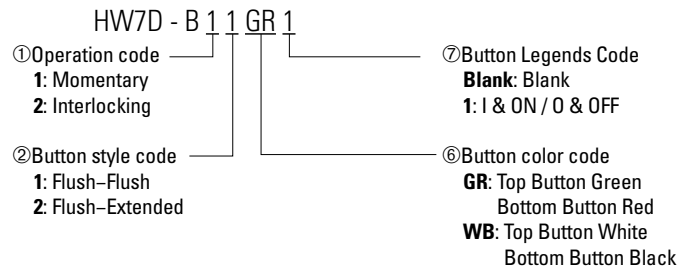

Contact unit

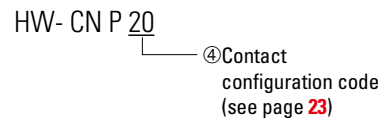

Operator unit (with pilot light)

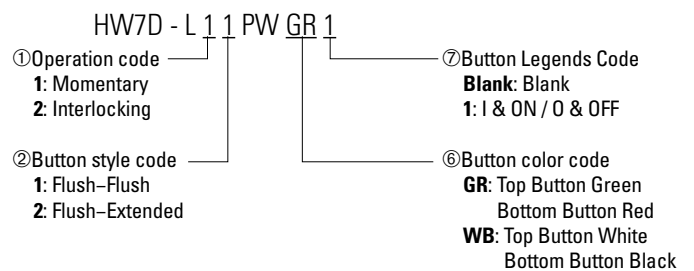

Contact unit (for illuminated unit)

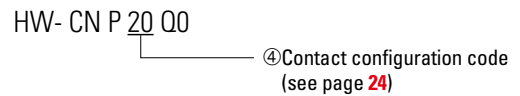

• LED lamps are not supplied.

LED Lamp

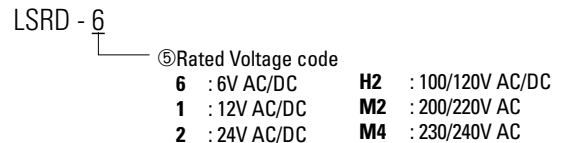

Dual Pushbuttons Dimensions

All dimensions in mm.

Without Pilot Light

Flush-Flush

1 to 2 contacts

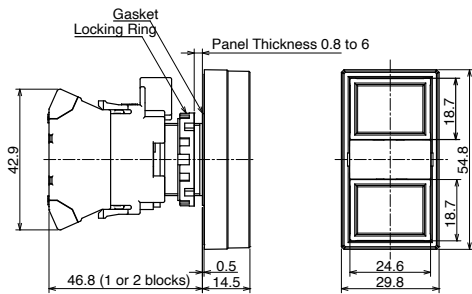

3 to 4 contacts

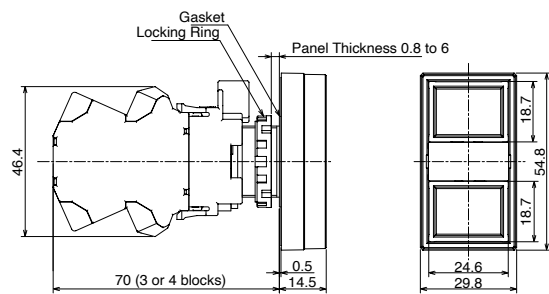

Flush-Extended

1 to 2 contacts

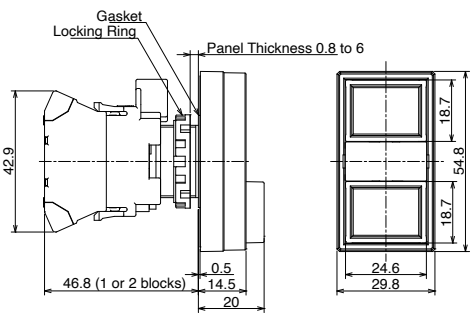

3 to 4 contacts

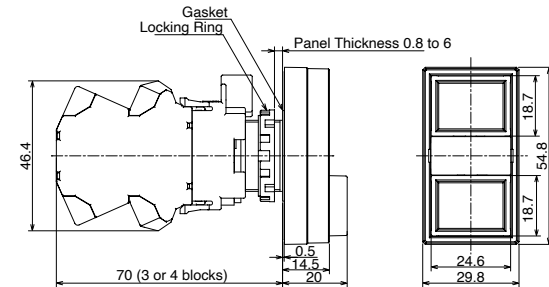

With Pilot Light

Flush-Flush

1 to 2 contacts

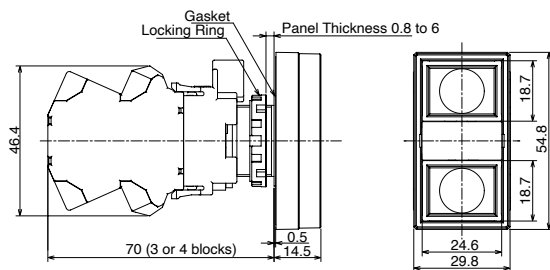

3 to 4 contacts

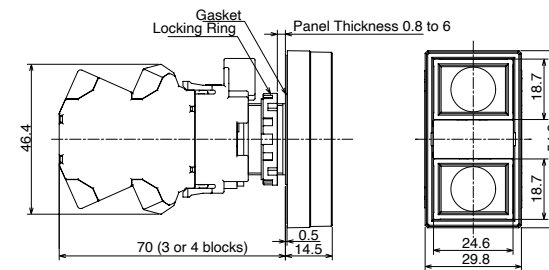

Flush-Extended

1 to 2 contacts

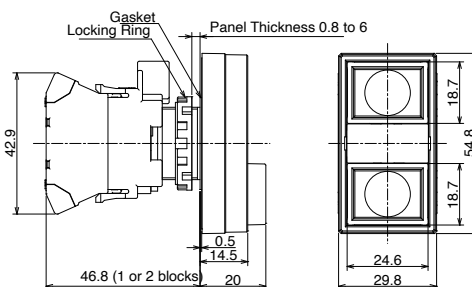

3 to 4 contacts

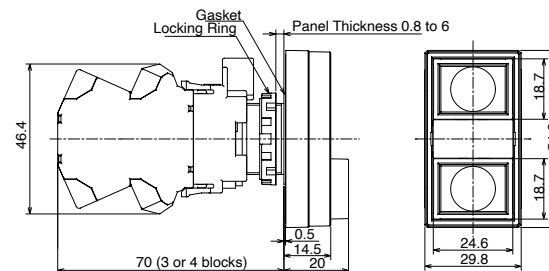

Selector Switches (Knob Operator)

Assembled



Package Quantity: 1

Shape	No. of Positions	Contact Configuration (Code)	Contact Block		Operator Position			Cam Code	Maintained	1 2							
			Mounting Position	Contact	1	2											
HWⓄS Ⓞ: Bezel Type 1: Black 2: Metal	90° 2-position	1NO (10)	(1)	NO		X		—	HWⓄS-2TP10	1 2							
			(3)	—		Dummy											
		1NC (01)	(1)	—		Dummy											
			(3)	NC	X												
		1NO-1NC (11)	(1)	NO		X											
			(3)	NC	X												
		2NO (20)	(1)	NO		X											
			(3)	NO		X											
	2NO-2NC (22)	(1)	NONC	NO		X		—	HWⓄS-2TP22	1 2							
				NC	X												
		(3)	NONC	NO		X											
				NC	X												
	45° 3-position		2NO (20)	(1)	NO	X			—	HWⓄS-3TP20	1 0 2	Spring return two-way					
				(3)	NO			X									
2NO-1NC (21N1) ★☆			(1)	NONC	NO	X							J	HWⓄS-3JTP21N3	1 0 2		
			(3)	NO	NO		X	X									
2NO-2NC (22)			(1)	NONC	NO	X							—	HWⓄS-3TP22	1 0 2		
			(3)	NONC	NO		X	X									
4NO (40)			(1)	2NO	NO	X							—	HWⓄS-3TP40	1 0 2		
					NO	X											
			(3)	2NO	NO			X									
					NO			X									

- On the contact configuration marked with ★ in the table above, the rated load switching current is reduced to a half of the related current of the contact block. The rated insulation voltage and the rated thermal current remain unchanged.
- On the contact configuration marked with ☆ in the table above, contacts may overlap when the operator position is changed.
- Knob operator: white indicator on black body
- Selector switches with 1 contact block contain 2 dummy blocks. Selector switches with 2 contact blocks contain 1 dummy block.
- Turn the operator to each position accurately.

Contact Block Mounting Position

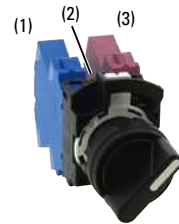

Note) (2) can only be mounted with a dummy block.

• For other contact configuration or operator position, select from sub-assembled units (page 27 to 28).

Dimensions

1 to 2 contacts

3 to 4 contacts

All dimensions in mm.

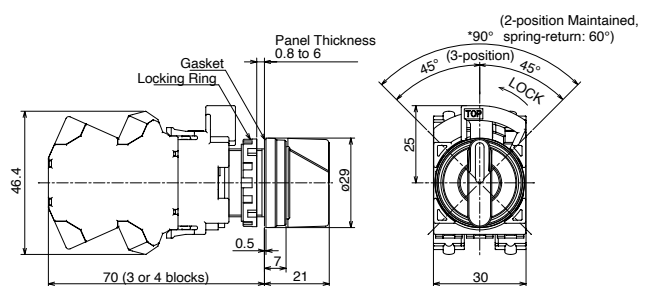
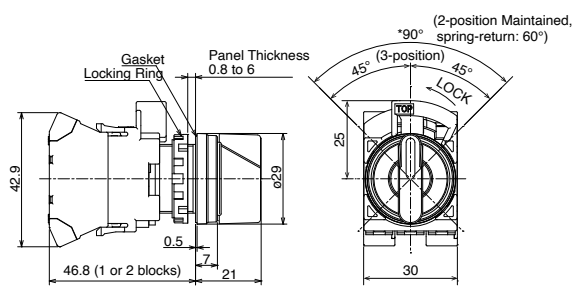

Selector Switches (Knob / Lever Operator) 2-Position

Sub-Assembled

When ordering, specify the sub-assembled ordering no. See page 26 for available assembled products.



90° 2-position

Package Quantity: 1

<Reference> Assembled Part No.						Operator Unit Ordering No.		Contact Unit					
No. of Positions	Contact Configuration (Code)	Contact Block		Operator Position		Cam Code	Operator Position Code Maintained $\begin{matrix} 1 & 2 \\ \diagdown & / \end{matrix}$	Operator type ④	Operator Position Code Maintained (90°) $\begin{matrix} 1 & 2 \\ \diagdown & / \end{matrix}$	Shape	Part No. (Ordering No.)		
		Mounting Position	Contact	1	2							<Reference> Assembled Part No.	Part No. (Ordering No.)
90° 2-position	1NO (10)	(1)	NO		X	—	HWⓉS-2④P10	Knob Operator	HWⓉS-2④		HW-CNP10		
		(3)	—		Dummy						HW-CNP01		
	1NC (01)	(1)	—		Dummy		HWⓉS-2④P01	Lever Operator		HWⓉS-2④P11		HW-CNP11	
		(3)	NC	X								HW-CNP20	
	1NO-1NC (11)	(1)	NO		X		HWⓉS-2④P20	HWⓉS-2④P02			HW-CNP22	HW-CNP20	
		(3)	NC	X								HW-CNP02	
	2NO (20)	(1)	NO		X		HWⓉS-2④P22	HWⓉS-2④P31N1			HW-CNP31N1	HW-CNP22	
		(3)	NC	X								HW-CNP40	
	2NC (02)	(1)	NC	X			HWⓉS-2④P40	HWⓉS-2④P03N2			HW-CNP03N2	HW-CNP40	
		(3)	NC	X								HW-CNP21N1	
	2NO-2NC (22)	(1)	NO		X		HWⓉS-2④P21N1	HWⓉS-2④P21N1			HW-CNP21N1	HW-CNP22	
		(3)	NC	X								HW-CNP31N1	
	3NO-1NC (31N1)	(1)	NO		X		HWⓉS-2④P31N1	HWⓉS-2④P40			HW-CNP40	HW-CNP31N1	
		(3)	NC	X								HW-CNP03N2	
	4NO (40)	(1)	NO		X		HWⓉS-2④P40	HWⓉS-2④P03N2			HW-CNP03N2	HW-CNP40	
		(4)	NO		X							HW-CNP21N1	
	3NC (03N2)	(1)	NC	X			HWⓉS-2④P03N2	HWⓉS-2④P21N1			HW-CNP21N1	HW-CNP03N2	
		(3)	NC	X								HW-CNP31N1	
2NO-1NC (21N1)	(1)	2NO	NO		X	HWⓉS-2④P21N1		HW-CNP21N1	HW-CNP21N1				
	(3)	NC	NC	X					HW-CNP31N1				

90° 2-position Reversed Cam

Package Quantity: 1

<Reference> Assembled Part No.						Operator Unit Ordering No.		Contact Unit					
No. of Positions	Contact Configuration (Code)	Contact Block		Operator Position		Cam Code	Operator position code Maintained $\begin{matrix} 1 & 2 \\ \diagdown & / \end{matrix}$	Shape	Operator position code Maintained (90°) $\begin{matrix} 1 & 2 \\ \diagdown & / \end{matrix}$	Shape	Part No. (Ordering No.)		
		Mounting Position	Contact	2	1							<Reference> Assembled Part No.	Part No. (Ordering No.)
90° 2-position	2NC (02)	(1)	NC		X	J	HWⓉS-2J④TP02	Knob Operator	HWⓉS-2J④		HW-CNP02		
		(3)	NC		X							HW-CNP02	

• For part no. other than maintained position, see Part No. Example on page 29.

Note: Turn the operator to each position accurately.

• Specify an operator unit code in place of ④ in the Part No.

• Ⓣ Bezel Type: 1: Black, 4: Metal

④Operator Unit Code

Code	Operator style	Code	Operator style
T	Knob Operator	L	Lever Operator

For Part No. (Ordering No.)/ mounting positions of contact units, see page 51.

Selector Switches (Knob / Lever Operator) 3-Position

Sub-Assembled

When ordering, specify the sub-assembled ordering no. See page 26 for available assembled products.



45° 3-position

Package Quantity: 1

No. of Positions	<Reference> Assembled Part No.						Operator Unit Ordering No.		Contact unit				
	Contact Configuration (Code)	Contact Block		Operator Position			Cam Code	Operator position code Maintained 1 0 2	④ Operator type	Operator position code Maintained 1 0 2	Shape	Part No. (Ordering No.)	
		Mounting Position	Contact	1	0	2							Part No. (Ordering No.)
45° 3-position	1NO-1NC (11)	(1)	NO	X			—	HWⓄS-3④P11	Knob Operator	HWⓄS-3④		HW-CNP11	
		(3)	NC	X	X							HWⓄS-3④P11N1	HW-CNP11N1
	1NO-1NC (11N1)	(1)	NC			X	X	—	HWⓄS-3④P20	Lever Operator	HWⓄS-3④		HHW-CNP20
		(3)	NO				X						HWⓄS-3④P02
	2NO (20)	(1)	NO	X				—	HWⓄS-3④P01	Knob Operator	HWⓄS-3④		HW-CNP01
		(3)	NO				X						HWⓄS-3④P02
	2NC (02)	(1)	NC		X	X		—	HWⓄS-3④P01	Lever Operator	HWⓄS-3④		HW-CNP01
		(3)	NC	X	X								HWⓄS-3④P02
	1NO-1NC (11N1) ★ ☆	(1)	NC			X		J	HWⓄS-3J④P11N1	Knob Operator	HWⓄS-3J④		HW-CNP11N1
		(3)	NO				X						HWⓄS-3J④P21N3
	2NO-1NC (21N3) ★ ☆	(1)	NONC	NO	X			J	HWⓄS-3J④P21N3	Lever Operator	HWⓄS-3J④		HW-CNP21N3
		(3)	NO				X						HWⓄS-3④P22N1
	2NO-2NC (22)	(1)	NONC	NO	X			—	HWⓄS-3④P22N1	Knob Operator	HWⓄS-3④		HW-CNP22N1
		(3)	NONC	NO		X	X						HWⓄS-3④P22N2
	2NO-2NC (22N2)	(1)	2NC	NO		X	X	—	HWⓄS-3④P22N2	Lever Operator	HWⓄS-3④		HW-CNP22N2
		(3)	2NO	NO			X						HWⓄS-3④P40
4NO (40)	(1)	2NO	NO	X			—	HWⓄS-3④P40	Knob Operator	HWⓄS-3④		HW-CNP40	
	(3)	2NO	NO			X						HWⓄS-3④P04	HW-CNP04
4NC (04)	(1)	2NC	NC		X	X	—	HWⓄS-3④P04	Lever Operator	HWⓄS-3④		HW-CNP04	
	(3)	2NC	NC	X	X								

- On the contact configuration marked with ★ in the table above, the rated load switching current is reduced to a half of the related current of the contact block. The rated insulation voltage and the rated thermal current remain unchanged.
- On the contact configuration marked with ☆ in the table above, contacts may overlap when the operator position is changed.
- For part no. other than maintained position, see Part No. Example on page 29.
- Ⓞ Bezel Type: 1: Black, 4: Metal
- Specify an operator unit code in place of ④ in the Part No.

④Operator Unit Code

Code	Operator style	Code	Operator style
T	Knob Operator	L	Lever Operator

Note: Turn the operator to each position accurately.

Contact Block Mounting Position

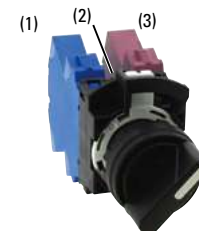

Note) (2) can only be mounted with a dummy block.

For Part No. (Ordering No.)/ mounting positions of contact units, see page 51.

Selector Switches (Knob / Lever Operator)

Selector Switches Part No. Example

Assembled and sub-assembled unit

Assembled (Without Pilot Light)

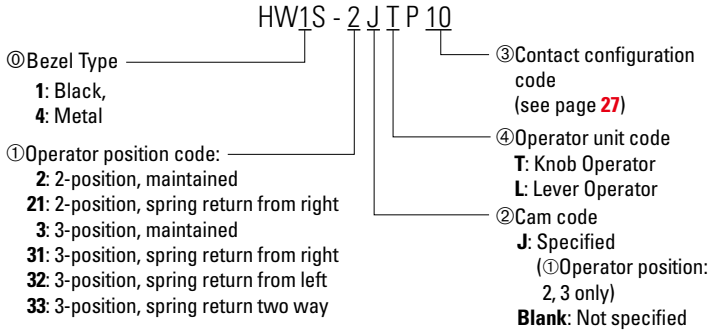

① Operator position code

Maintained (90° 2-position)		Spring Return (60° 2-position)
		Spring Return from Right
Cam code: blank	Cam code: J	Cam code: blank

• For available assembled products, see table on page 26.

Operator Truth Tables

2 Position Selector Switches

	Contact	Mounting Position	Operator Position	
			Left	Right
HW①S-2T HW①K-2* HW①F-2	HW-P10 (NO)	1	0	X
		3	0	X
	HW-P01 (NC)	1	X	0
		3	X	0
	HW-P10R (NO-EM)	1	0	X
		3	0	X

3 Position Selector Switches

	Contact	Mounting Position	Operator Position		
			Left	Center	Right
HW①S-3T HW①K-3* HW①F-3	HW-P10 (NO)	1	X	0	0
		3	0	0	X
	HW-P01 (NC)	1	0	X	X
		3	X	X	0
	HW-P10R (NO-EM)	1	X	0	0
		3	0	0	X

	Contact	Mounting Position	Operator Position		
			Left	Center	Right
HW①S-3ST HW①K-3S*	HW-P10 (NO)	1	X	0	0
		3	0	0	X
	HW-P01 (NC)	1	0	0	X
		3	X	0	0
	HW-P10R (NO-EM)	1	X	X	0
		3	0	X	X

1. Mounting position indicates which side of operator each contact should be mounted (as viewed from the front of the panel).
2. *For key removable code see page 33

Operator (Without Pilot Light)

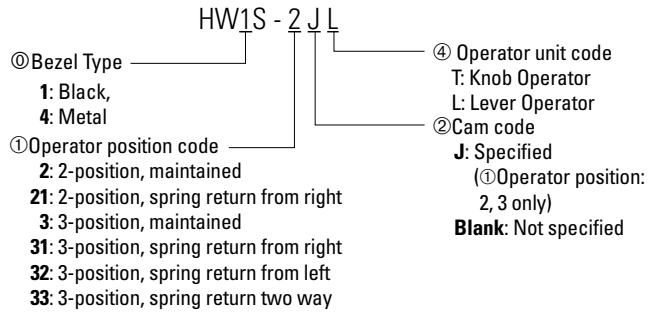

Contact Unit

HW- CN P 10

③ Contact configuration code (see page 27, 28)

Maintained (45° 3-position)	Spring Return (45° 3-position)		
	Spring return from right 	Spring return from left 	Spring return two-way
Cam code: Blank, J, or S	Cam code: blank		

3 Position Selector Switches con't

	Contact	Mounting Position	Operator Position		
			Left	Center	Right
HW①S-3JT HW①K-3J*	HW-P10 (NO)	1	X	0	0
		3	0	0	X
	HW-P01 (NC)	1	0	X	0
		3	0	X	0
	HW-P10R (NO-EM)	1	X	0	X
		3	X	0	X

4 Position Selector Switches

	Contact	Mounting Position	Operator Position			
			1	2	3	4
HW①S-4T	HW-P10 (NO)	1	X	0	0	0
		3	0	0	0	X
	HW-P01 (NC)	1	0	0	X	0
		3	0	X	0	0
	HW-P10R (NO-EM)	1	X	X	0	X
		3	X	0	X	X

5 Position Selector Switches

	Contact	Mounting Position	Operator Position				
			1	2	3	4	5
HW①S-5T	HW-P10 (NO)	1	X	0	0	0	0
		3	0	0	0	0	X
	HW-P01 (NC)	1	0	0	0	X	0
		3	0	X	0	0	0
	HW-P10R (NO-EM)	1	X	X	X	0	X
		3	X	0	X	X	X

3. HW1S-3T is identified by white plungers on the operator.
4. HW1S-3ST is identified by red plungers on the operator.
5. HW1S-3JT is identified by black plungers on the operator.













Pin tumbler keys can be purchased only as a sub-assembled product.

Key Selector Switches (Disc Tumbler Key)

Assembled



Package Quantity: 1

Name / Shape	No. of Positions	Contact Configuration (Code)	Contact Block		Operator Position			Cam Code	Operator position code			
			Mounting Position	Contact	1	2			Maintained (90°)			
Disc Tumbler Key HW1K / HW4K  (NC contact only)	90° 2-position	1NO (10)	(1)	NO		X		—	Maintained (90°) 			
			(3)	—			Dummy					
		1NO-1NC (11)	(1)	NO		X			—	Maintained (90°) 		
			(3)	NC	X							
		2NO (20)	(1)	NO		X				—	Maintained (90°) 	
			(3)	NO		X						
	2NO-2NC (22)	(1)	NONC	NO	X		—	Maintained (90°) 				
		(3)	NONC	NC	X							
	NO			X								
	NC	X										
			Operator position code		Maintained			Spring return from right				
												
45° 3-position	2NO (20)	Contact Code	Mounting Position	Contact	1	0	2	—	Maintained 			
											(1)	NO
		(3)	NO			X						
		1NO-1NC (11N1)	(1)	NC		X			J	Maintained 		
			(3)	NO			X					
		2NO-2NC (22)	(1)	NONC	NO	X	X			—	Spring return from right 	
	(3)		NONC	NO	X	X						
		NC		X	X							
			Operator position code		Maintained		Spring return from right					
												
	2a-2b (22N2)	(1)	2NC	NC	X	X	—	Spring return from right 				
		(3)	2NO	NC	X	X						
NO	X			X								
NO	X	X										

• Selector switches with 1 contact block contain 2 dummy blocks.
 Selector switches with 2 contact blocks contain 1 dummy block.



• Standard key number (231) is available for assembled products.
 *For numbers other than standard key numbers, contact IDEC.

• For other contact configuration or operator position, select from sub-assembled units (page 31 to 32).

Key removal position





Ⓞ Bezel Type 1: Black, 4: Metal

① 90° 2-position

Key Retained Position (Cam code: blank)	
A: Key removable in all positions 	B: Key removable at left 

①②: Key removal position ①②: Key retained position

② 45° 3-position

Key Retained Position			
A: Key removable in all positions 	B: Key removable at left / center 	D: Key removable at center 	G: Key removable at left 

Ⓞ①②: Key removal position ①①②: Key retained position

Note: The key cannot be removed in a spring return position.

Contact Block Mounting Position

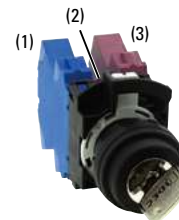

Note) (2) can only be mounted with a dummy block.

Pin tumbler keys can be purchased only as a sub-assembled product.

Key Selector Switches (Disc Tumbler Key / Pin Tumbler Key) 2-Position

Sub-Assembled

When ordering, specify the sub-assembled ordering no. See page 30 for available assembled products.

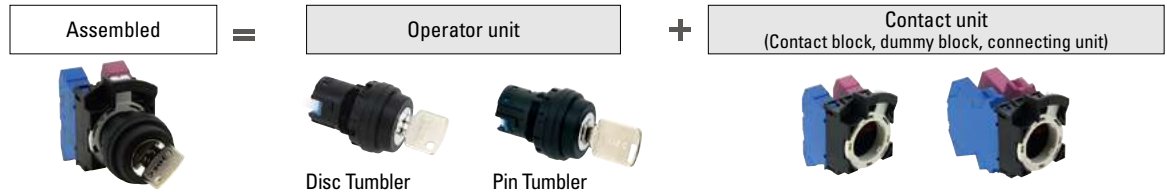

90° 2-position

Package Quantity: 1

No. of Positions	Contact Configuration (Code)	Contact Block		Operator Position		Cam Code	Operator position code		Operator Unit Ordering No.		Contact Unit	
		Mounting Position	Contact	1	2		Maintained	1	2	③Key Operator Type	Shape	Part No. (Ordering No.)
90° 2-position	1NO (10)	(1)	NO		X	—	HW⓪K-2③④P10	Disc Tumbler	HW⓪K-2③④⑥		HW-CNP10	
		(3)	—	Dummy							HW-CNP01	
	1NC (01)	(1)	—	Dummy			HW⓪K-2③④P01	Pin Tumbler		HW-CNP11		
		(3)	NC	X							HW-CNP20	
	1NO-1NC (11)	(1)	NO		X		HW⓪K-2③④P11	Pin Tumbler		HW-CNP02		
		(3)	NC	X							HW-CNP22	
	2NO (20)	(1)	NO		X		HW⓪K-2③④P20	Pin Tumbler		HW-CNP31		
		(3)	NO		X						HW-CNP40	
	2NC (02)	(1)	NC	X			HW⓪K-2③④P02	Pin Tumbler		HW-CNP03N2		
		(3)	NC	X							HW-CNP21N1	
	2NO-2NC (22)	(1)	NONC	NO	X		HW⓪K-2③④P22	Pin Tumbler		HW-CNP31		
		(3)	NONC	NO	X						HW-CNP40	
	3NO-1NC (31)	(1)	NONC	NO	X		HW⓪K-2③④P31	Pin Tumbler		HW-CNP03N2		
		(3)	NONC	NO	X						HW-CNP21N1	
	4NO (40)	(1)	2NO	NO	X		HW⓪K-2③④P40	Pin Tumbler		HW-CNP03N2		
		(3)	2NO	NO	X						HW-CNP21N1	
	3NC (03N2)	(1)	2NC	NC	X		HW⓪K-2③④P03N2	Pin Tumbler		HW-CNP03N2		
		(3)	NC	NC	X						HW-CNP21N1	
2NO-1NC (21N1)	(1)	2NO	NO	X	HW⓪K-2③④P21N1	Pin Tumbler	HW-CNP03N2					
	(3)	NC	NC	X				HW-CNP21N1				

• For part no. other than maintained position, see Part No. Example on page 33.

• Each selector key switch is supplied with two keys.

• ⓪ Bezel Type 1: Black, 4: Metal

• Specify the key style in ③.

③Key type code

Code	Key Operator Shape
Blank	Disc tumbler
P	Pin tumbler

} See page 33 Part No. Development for details.

• Specify the desired key removal position in ④.

• Specify the key number in ⑥.

For Part No. (Ordering No.)/ mounting positions of contact units, see page .

Pin tumbler keys can be purchased only as a sub-assembled product.

Key Selector Switches (Disc Tumbler Key / Pin Tumbler Key) 3-Position

Sub-Assembled

When ordering, specify the sub-assembled ordering no. See page 30 for available assembled products.



45° 3-position

Package Quantity: 1

No. of Positions	Contact Configuration (Code)	Contact Block		Operator Position			Cam Code	Operator position code		Operator Unit Ordering No.		Contact Unit			
		Mounting Position	Contact	1	0	2		Maintained	1 0 2	Key Operator Type	Maintained	1 0 2	Shape	Part No. (Ordering No.)	
				☐	☐	☐		☐	☐		☐				
				<Reference> Assembled Part No.		Part No. (Ordering No.)									
45° 3-position	1NO-1NC (11)	(1)	NO	X			—	HW④K-3③④P11	Disc Tumbler				HW-CNP11		
		(3)	NC	X	X										
	1NO-1NC (11N1)	(1)	NC			X		X	HW④K-3③④P11N1		HW④K-3④⑥				HW-CNP11N1
		(3)	NO					X							
	2NO (20)	(1)	NO	X					HW④K-3③④P20						HHW-CNP20
		(3)	NO					X							
	2NC (02)	(1)	NC			X		X	HW④K-3③④P02	Pin Tumbler					HW-CNP02
		(3)	NC	X	X										
	1NO-1NC (11N1) ★ ☆	(1)	NC			X			J HW④K-3J③④P11N1						HW-CNP11N1
		(3)	NO					X							
	2NO-1NC (21N3) ★ ☆	(1)	NONC	NO	X				J HW④K-3J③④P21N3		HW④K-3J④⑥				HW-CNP21N3
		(3)	NO					X							
	2NO-2NC (22)	(1)	NONC	NO	X				HW④K-3③④P22						HW-CNP22N1
		(3)	NONC	NO				X							
	2NO-2NC (22N2)	(1)	NONC	NC		X		X	HW④K-3③④P22N2						HW-CNP22N2
		(3)	NONC	NO				X							
4NO (40)	(1)	NONC	NO	X			HW④K-3③④P40		HW④K-3④⑥				HW-CNP40		
	(3)	NONC	NO			X									
4NC (04)	(1)	NONC	NC		X	X	HW④K-3③④P04						HW-CNP04		
	(3)	NONC	NC	X	X										

- On the contact arrangement marked with ★ in the table above, the rated load switching current is reduced to a half of the related current of the contact block. The rated insulation voltage and the rated thermal current remain unchanged.
 - For models with ☆, contacts may overlap when the operator position is changed.
 - For part no. other than maintained position, see Part No. Example on page 33.
 - Each selector key switch is supplied with two keys.
 - ④ Bezel Type 1: Black, 4: Metal
 - Specify the key style in ③.
- ③Key type code
- | Code | Key Operator Shape |
|-------|--------------------|
| Blank | Disc tumbler |
| P | Pin tumbler |
- See page 33 Part No. Development for details.
- Specify the desired key removal position in ④.
 - Specify the key number in ⑥.

Contact Block Mounting Position

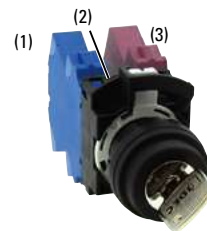

Note) (2) can only be mounted with a dummy block.

For Part No. (Ordering No.)/ mounting positions of contact units, see page 51.

Key Selector Switches (Disc Tumbler Key / Pin Tumbler Key)

Key Selector Switches Part No. Example

Assembled and sub-assembled unit

Assembled Part No. Example

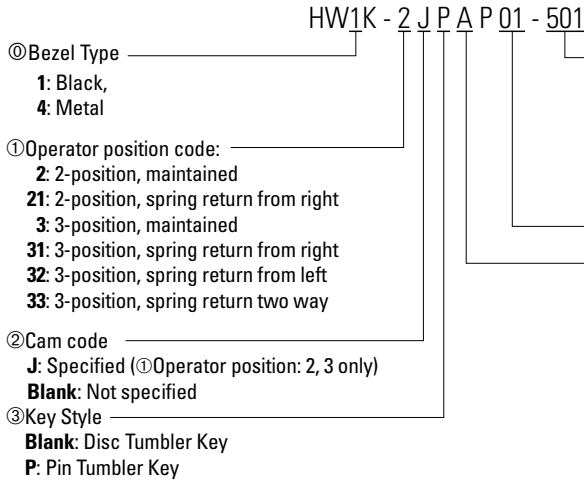

⑥ Key No.
Disc Tumbler Key
Blank: Standard (231)

*For key numbers other than the standard key number, contact us.

Pin Tumbler Key
Blank: Standard (500)
-501 to -515 (non-standard)

Note: The key number is engraved on the key cylinder.

⑤ Contact configuration code

④ Key removal position
2-position

A: Removable in all positions
B: Removable in the left only
C: Removable in the right only

3-position

A: Removable in all positions
B: Removable in the left and center
C: Removable in the right and center
D: Removable in center only
E: Removable in right and left
G: Removable in left only
H: Removable in right only

Operator unit

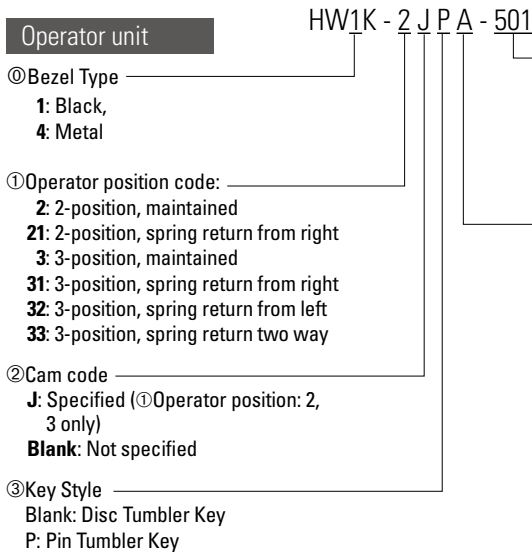

⑥ Key No.
Disc Tumbler Key
Blank: Standard (231)

*For key numbers other than the standard key number, contact us.

Pin Tumbler Key
Blank: Standard (500)
-501 to -515 (non-standard)

Note: The key number is engraved on the key cylinder.

④ Key removal position
2-position

A: Removable in all positions
B: Removable in the left only
C: Removable in the right only

3-position

A: Removable in all positions
B: Removable in the left and center
C: Removable in the right and center
D: Removable in center only
E: Removable in right and left
G: Removable in left only
H: Removable in right only

Contact unit

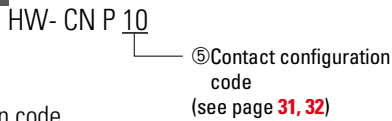

① Operator position code

Maintained (90° 2-position)		Spring Return (60° 2-position)
Cam code: blank	Cam code: J	Cam code: blank

Maintained (45° 3-position)	Spring Return (45° 3-position)		
Cam code: Blank, J, or S	Cam code: blank		

• For available assembled products, see table on page 30.

④ Key removal position

90° 2-position / 60° 2-position

Key Retained Position (Cam code: blank)		
A: Key removable in all positions 	B: Key removable at left 	C: Key removable at right

Key Retained Position (Cam code: J)		
A: Key removable in all positions 	B: Key removable at left 	C: Key removable at right

45° 3-position

Key Retained Position			
A: Key removable in all positions 	B: Key removable at left / center 	C: Key removable at center / right 	D: Key removable at center
E: Key removable at right / left 	G: Key removable at left 	H: Key removable at right 	

①①② : Key removal position ①①② : Key retained position

Note: The key cannot be removed in a spring return position.

Key Selector Switches (Pin Tumbler Key)

All dimensions in mm.

Dimensions

Disc Tumbler Key

1 to 2 contacts

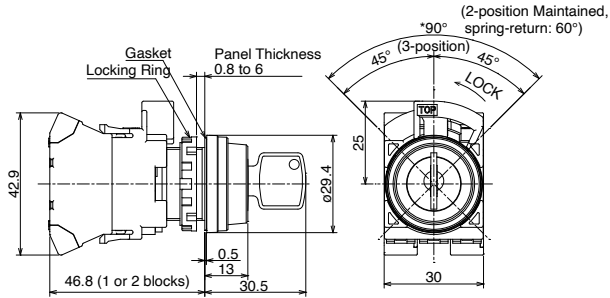

3 to 4 contacts

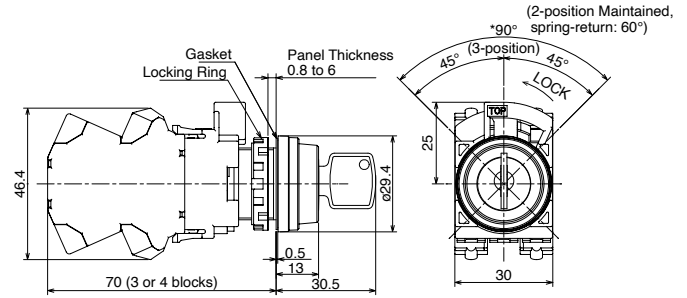

Pin Tumbler Key

1 to 2 contacts

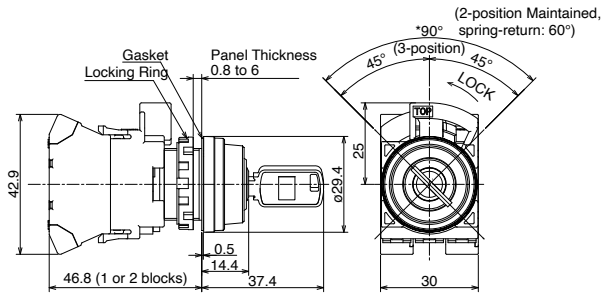

3 to 4 contacts

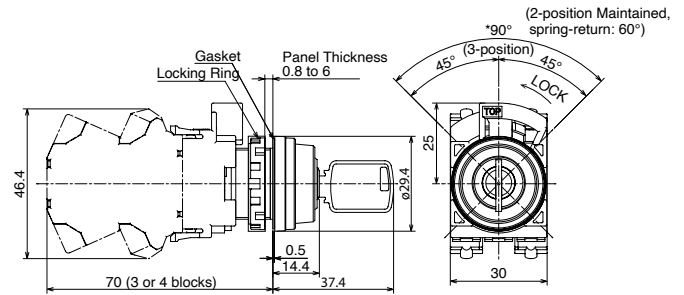

Lever operator can be purchased only as a sub-assembled product.

Illuminated Selector Switches (Knob / Lever Operator) (LED)

Assembled



Package Quantity: 1

Name / Shape	No. of Positions	Contact Configuration Table						Operating Voltage	Functional Specifications		© Illumination Color Code	
		Contact Configuration	Contact Block		Operator Position		Maintained 1 2		—			
			Mounting Position	Contact	1	2						
	90° 2-position	1NO (10)	(1)	NO		X	24V AC/DC	HW®F-2P10Q4®		R (red) G (green) Y (yellow) A (amber) S (blue) PW (pure white)		
			(3)	Dummy							HW®F-2P11Q4®	
		1NO-1NC (11)	(1)	NO		X		100/120V AC/DC			HW®F-2P20Q4®	
			(3)	—	X							HW®F-2P22Q4®
		2NO (20)	(1)	NO		X		100/120V AC/DC			HW®F-2P10QH2®	
			(3)	NO		X						HW®F-2P11QH2®
		2NO-2NC (22)	(1)	NONC	NO			X			100/120V AC/DC	HW®F-2P20QH2®
					NC	X						
			(3)	NONC	NO			X			100/120V AC/DC	HW®F-2P20QH2®
					NC	X						
	1NO (10)	(1)	NO		X	100/120V AC/DC	HW®F-2P10QH2®					
		(3)	—	Dummy				HW®F-2P11QH2®				
	1NO-1NC (11)	(1)	NO		X	100/120V AC/DC	HW®F-2P20QH2®					
		(3)	NC	X								
2NO (20)	(1)	NO		X	100/120V AC/DC	HW®F-2P20QH2®						
	(3)	NO		X								
Name / Shape	No. of Positions	Contact Configuration Table						Cam Code	Operator position code		© Illumination Color Code	
		Contact Configuration	Contact Block		Operator Position		Maintained 1 0 2		Spring return two-way 1 0 2			
			Mounting Position	Contact	1	0				2		
	45° 3-position	2NO (20)	(1)	NO	X		24V AC/DC	HW®F-3P20Q4®	HW®F-33P20Q4®	R (red) G (green) Y (yellow) A (amber) S (blue) PW (pure white)		
			(3)	NO							X	

- © Bezel Type 1: Black, 4: Metal
- Specify an illumination color code in place of © in the Part No.
- Turn the operator to each position accurately.

• For other contact configuration or operator position, select from sub-assembled units. (page 36 to 37).

Contact Block Mounting Position

(1) (2) (3)



Note) (2) can only be mounted with a full voltage adapter.

Illuminated Selector Switches (Knob / Lever Operator) (LED) 2-Position

Sub-Assembled

When ordering, specify the sub-assembled ordering no. See page 35 for available assembled products.



90° 2-position

Package Quantity: 1

No. of Positions	<Reference> Assembled Part No					Operator Unit		Contact Unit (Illuminated)									
	Contact Configuration	Contact Block		Operator Position		Cam Code	Operator position code		Shape	Part No. (Ordering No.)							
		Mounting Position	Contact	1	2		Maintained	1 2			Part No. (Ordering No.)						
90° 2-position	1NO (10)	(1)	NO		X	—	Maintained	1 2			HW⓪F-2③P10⑤⑥	Knob Operator	HW⓪F-2③⑥-PI-USA		HW-CNP10Q0		
		(3)	—		Dummy												
	1NC (01)	(1)	—		Dummy								HW⓪F-2③P01⑤⑥	Lever Operator	HW⓪F-2③⑥-PI-USA		HW-CNP01Q0
		(3)	NC	X													
	1NO-1NC (11)	(1)	NO		X								HW⓪F-2③P11⑤⑥	Lever Operator	HW⓪F-2③⑥-PI-USA		HW-CNP11Q0
		(3)	NC	X													
	2NO (20)	(1)	NO		X								HW⓪F-2③P20⑤⑥	Lever Operator	HW⓪F-2③⑥-PI-USA		HW-CNP20Q0
		(3)	NO		X												
	2NC (02)	(1)	NC	X									HW⓪F-2③P02⑤⑥	Lever Operator	HW⓪F-2③⑥-PI-USA		HW-CNP02Q0
		(3)	NC	X													
	2NO-2NC (22)	(1)	NONC	NO	X								HW⓪F-2③P22⑤⑥	Lever Operator	HW⓪F-2③⑥-PI-USA		HW-CNP22Q0
		(3)	NONC	NO	X												
	3NO-1NC (31)	(1)	NONC	NO	X								HW⓪F-2③P31⑤⑥	Lever Operator	HW⓪F-2③⑥-PI-USA		HW-CNP31Q0
		(3)	NONC	NO	X												
	4NO (40)	(1)	2NO	NO	X								HW⓪F-2③P40⑤⑥	Lever Operator	HW⓪F-2③⑥-PI-USA		HW-CNP40Q0
		(3)	2NO	NO	X												
	3NC (03N2)	(1)	2NC	NC	X								HW⓪F-2③P03N2⑤⑥	Lever Operator	HW⓪F-2③⑥-PI-USA		HW-CNP03N2Q0
		(3)	NC	NC	X												

• ⓪ Bezel Type 1: Black, 4: Metal

• Specify an operator unit code in place of ③ in the Part No.

③Operator Unit Code

Code	Operator style
Blank	Knob Operator
L	Lever Operator

• Specify a rated voltage code in place of ⑤ in the Part No.

Code	Rated voltage	Code	Rated voltage
Q2	6V AC/DC	QH2	100/120V AC/DC
Q3	12V AC/DC	QM	200/220V AC
Q4	24V AC/DC	QM4	230/240V AC

• Specify an illumination color code in place of ⑥ in the Part No.
R (red), G (green), Y (yellow), A (amber), S (blue), PW (pure white)

• For part no. other than maintained position, see Part No. Example on page 38.

Note) LED lamp is not supplied. When ordering contact units (illuminated) selected LED from below table.

LED lamp (package quantity:1)	
Rated Voltage	Part No. (Ordering No.)
6V AC/DC	LSRD-6
12V AC/DC	LSRD-1
24V AC/DC	LSRD-2
100/120V AC/DC	LSRD-H2
200/220V AC	LSRD-M2
230/240V AC	LSRD-M4

For Part No. (Ordering No.)/ mounting positions of contact units, see page 51.





















Illuminated Selector Switches (Knob / Lever Operator) (LED) 3-Position

Sub-Assembled

When ordering, specify the sub-assembled ordering no. See page 35 for available assembled products.

45° 3-position

Package Quantity: 1

No. of Positions	Contact Configuration	Contact Block		Operator Position			<Reference> Assembled Part No		Operator Unit		Contact Unit (Illuminated)								
		Mounting Position	Contact	1	0	2	Operator position code		Name / Shape	Operator position code		Shape	Part No. (Ordering No.)						
							Maintained	1 0 2		Maintained	1 0 2								
45° 3-position	1NO-1NC (11)	(1)	NO	X			HWⓄF-3③P11⑤⑥	Knob Operator	HWⓄF-3③⑥-PI-USA			HW-CNP1100							
		(3)	NC	X	X								HW-CNP11N100						
	1NO-1NC (11N1)	(1)	NC		X	X	HWⓄF-3③P11N1⑤⑥	Lever Operator				HWⓄF-3③⑥-PI-USA			HHW-CNP2000				
		(3)	NO			X										HW-CNP0200			
	2NO (20)	(1)	NO	X			HWⓄF-3③P20⑤⑥	Knob Operator				HWⓄF-3③⑥-PI-USA			HW-CNP11N100				
		(3)	NO			X										HW-CNP30N100			
	2NC (02)	(1)	NC		X	X	HWⓄF-3③P02⑤⑥	Lever Operator		HWⓄF-3③⑥-PI-USA						HW-CNP22N100			
		(3)	NC	X	X												HW-CNP22N200		
	1NO-1NC (11N1) ★☆	(1)	NC		X		HWⓄF-3J③P11N1⑤⑥	Knob Operator		HWⓄF-3③⑥-PI-USA						HW-CNP11N100			
		(3)	NO			X											HW-CNP4000		
	2NO-1NC (21N3) ★☆	(1)	NONC	NO	X		HWⓄF-3J③P21N3⑤⑥	Lever Operator					HWⓄF-3③⑥-PI-USA				HW-CNP0400		
		(3)	NONC	NC		X												HW-CNP0400	
	2NO-2NC (22)	(1)	NONC	NO	X		HWⓄF-3③P22⑤⑥	Knob Operator					HWⓄF-3③⑥-PI-USA				HW-CNP22N100		
		(3)	NONC	NC		X											X		HW-CNP22N200
	2NO-2NC (22N2)	(1)	2NC	NO		X	X	HWⓄF-3③P22N2⑤⑥			Lever Operator				HWⓄF-3③⑥-PI-USA				HW-CNP4000
		(3)	2NO	NO			X												
	4NO (40)	(1)	2NO	NO	X		HWⓄF-3③P40⑤⑥	Knob Operator			HWⓄF-3③⑥-PI-USA							HW-CNP22N200	
		(3)	2NO	NO														X	
4NC (04)	(1)	2NC	NC		X	X	HWⓄF-3③P04⑤⑥	Lever Operator	HWⓄF-3③⑥-PI-USA									HW-CNP0400	
	(3)	2NC	NC	X	X														HW-CNP0400

- Ⓞ Bezel Type 1: Black, 4: Metal
- Specify an operator unit code in place of ③ in the Part No.

③ Operator Unit Code

Code	Operator style
Blank	Knob Operator
L	Lever Operator

- Specify a rated voltage code in place of ⑤ in the Part No.

Code	Rated voltage	Code	Rated voltage
Q2	6V AC/DC	QH2	100/120V AC/DC
Q3	12V AC/DC	QM	200/220V AC
Q4	24V AC/DC	QM4	230/240V AC

- Specify an illumination color code in place of ⑥ in the Part No.
R (red), G (green), Y (yellow), A (amber), S (blue), PW (pure white)

- For part no. other than maintained position, see Part No. Example on page 38.

Note) LED lamp is not supplied. When ordering contact units (illuminated) selected LED from below table.

LED lamp (package quantity:1)	
Rated Voltage	Part No. (Ordering No.)
6V AC/DC	LSRD-6
12V AC/DC	LSRD-1
24V AC/DC	LSRD-2
100/120V AC/DC	LSRD-H2
200/220V AC	LSRD-M2
230/240V AC	LSRD-M4

Contact Block Mounting Position

(1) (2) (3)



Note) (2) can only be mounted with a LED module.

Illuminated Selector Switches (Knob / Lever Operator) (LED)

All dimensions in mm.

Dimensions

Knob Operator

1 to 2 contacts

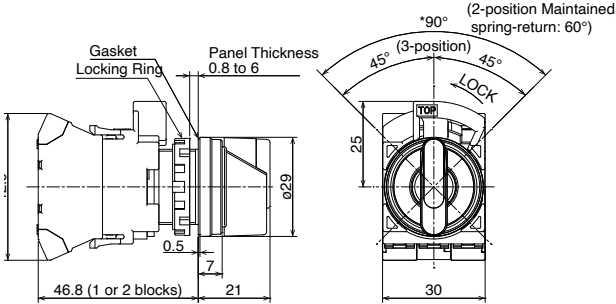

3 to 4 contacts

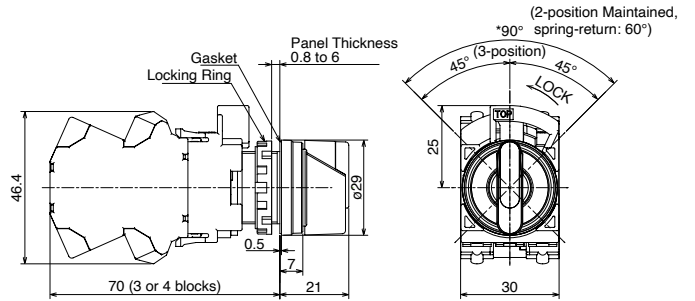

Lever Operator

1 to 2 contacts

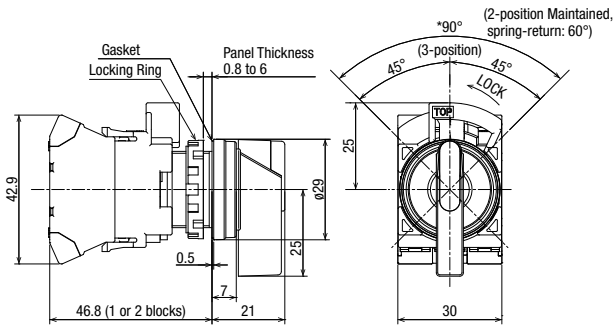

3 to 4 contacts

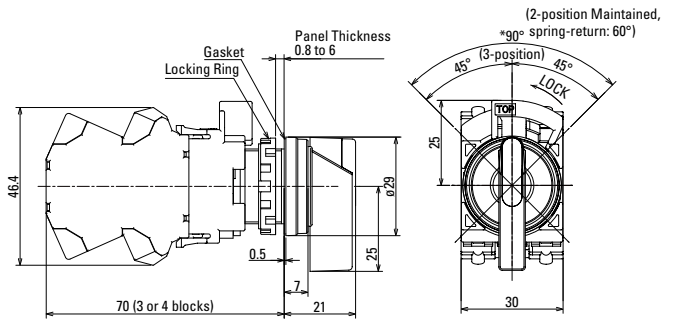

Illuminated Selector Switches Part No. Example

Assembled and sub-assembled unit

Assembled Part No. Example

HW1F - 2 J L P 11 Q4 R

- ① Bezel Type
1: Black,
4: Metal
- ② Operator position code:
2: 2-position, maintained
21: 2-position, spring return from right
3: 3-position, maintained
31: 3-position, spring return from right
32: 3-position, spring return from left
33: 3-position, spring return two way
- ③ Cam code
J: Specified
(① Operator position: 2, 3 only)
Blank: Not specified
- ④ Operator unit code
Blank: Knob Operator
L: Lever Operator
- ⑤ Illuminated color code (see page 37)
- ⑥ Operating voltage
Q2 : 6V AC/DC
Q3 : 12V AC/DC
Q4 : 24V AC/DC
QH2 : 100/120V AC/DC
QM : 200/220V AC
QM4 : 200/240V AC
- ⑦ Contact configuration code (see page 35)

Operator unit

HW1F - 2 L R - PI-USA

- ① Bezel Type
1: Black,
4: Metal
- ② Operator position code
2: 2-position, maintained
21: 2-position, spring return from right
3: 3-position, maintained
31: 3-position, spring return from right
32: 3-position, spring return from left
33: 3-position, spring return two way
- ③ Illuminated color code (see page 37)
- ④ Operator unit code
T: Knob Operator
L: Lever Operator

Contact Unit (for illuminated unit)

HW- CN P 20 Q0

- ④ Contact configuration code (see page 36, 37)

Note) LED lamps are not supplied.

LED Lamp

LSRD - 6

- ⑤ Rated voltage code
6: 6V AC/DC H2: 100/120V AC/DC
1: 12V AC/DC M2: 200/220V AC
2: 24V AC/DC M4: 230/240V AC

Selector Pushbuttons

Assembled



Package Quantity: 1

Name / Shape	Circuit Code.	Contact Configuration	Contact Block		Left		Right		Ring Operator	③ Button Color Code
			Mounting Position	Contact	Normal	Push	Normal	Push	Part No. (Ordering No.)	
 HW1R	D	2NO (20)	(1)	NO		X			HW1R-2DP20③	B (black) G (green)
			(3)	NO				X		

- Specify a button color code in place of ③ in the part No.
- When operating the pushbutton selector, do not turn the operator ring or the lock lever while the button is depressed. Otherwise the pushbutton selector may be damaged.

• For other circuit codes, select from sub-assembled units (page 40).

Contact Block Mounting Position

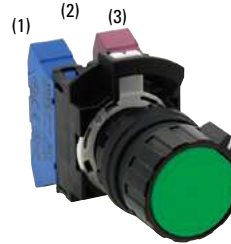

Note) (2) can only be mounted with a dummy block.

Dimensions

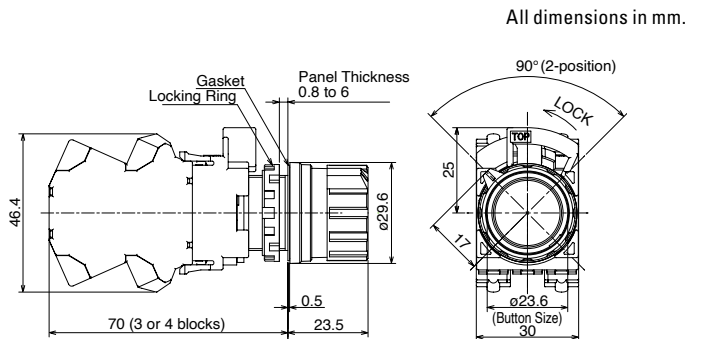
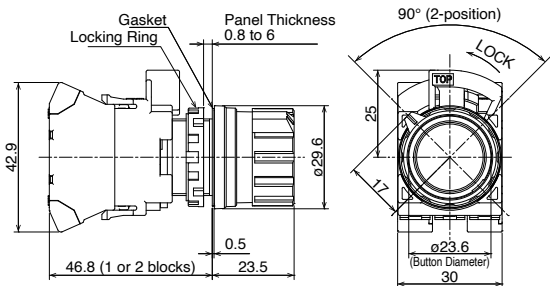

All dimensions in mm.

Selector Pushbuttons Part No. Example

Assembled and sub-assembled unit

Assembled Part No. Example

HW1R - 2 D P 20 B

① Circuit code (see page 40) — HW1R — ⑤ Button color code (see page 40)

② Contact configuration code

- 11: 1NO1NC
- 20: 2NO
- 22: 2NO-2NC
- 11N1: 1NO-1NC
- 22N2: 2NO-2NC

• For available assembled products, see table on page 40.

Operator unit

HW1R - 2 A B

① Circuit code (see page 40) — HW1R - 2 — ③ Button color code (see page 40)

Contact unit

HW - CN P 10

⑤ Contact configuration code (see page 40)

Selector Pushbuttons

Sub-Assembled

When ordering, specify the sub-assembled ordering no. See page 39 for available assembled products.



Sub-Assembled Ordering No.

Package Quantity: 1

<Reference> Assembled Part No.									
Circuit Code	Contact Configuration (Code)	Contact Block		Left		Right		Ring Operator	③ Button Color Code
		Mounting Position	Contact	Normal	Push	Normal	Push	Part No. (Ordering No.)	
A	1NO-1NC (11)	(1)	NO		X		X	HW1R-2AP11③	B (black) G (green) R (red) Y (yellow) S (blue) W (white)
		(3)	NC	X					
	2NO (20)	(1)	NO		X		X	HW1R-2AP20③	
		(3)	NO		X	X	X		
	2NO-2NC (22)	(1)	2NO	NO		X		HW1R-2AP22N1③	
				NO		X			
(3)		2NC	NC	X					
			NC	X					
D	2NO (20)	(1)	NO		X		HW1R-2DP20③		
		(3)	NO			X			
	2NO-2NC (22)	(1)	NONC	NO		X		HW1R-2DP22③	
				NC	X		X		
		(3)	NONC	NO			X		
				NC	X	X			
E	2NO-2NC (22)★	NONC	NO			X	HW1R-2EP22③		
			NC			X			
	(3)	NONC	NO			X			
			NC	X	X				
F	2NO-2NC (22)★☆	(1)	NONC	NO			HW1R-2FP22③		
				NC				X	
	(3)	NONC	NO		X				
			NC	X					
N	2NO-2NC (22N2)★☆	(1)	2NC	NC		X	HW1R-2NP22N2③		
				NC		X			
	(3)	2NO	NO		X	X			
			NO		X	X			
T	2NO-2NC (22)	(1)	NONC	NO		X	HW1R-2TP22③		
				NC	X				
	(3)	NONC	NO		X	X			
			NC	X		Operation Blocked			

Operator unit	Contact unit	
Part No. (Ordering No.)	Contact Configuration (Code)	Part No. (Ordering No.)
HW1R-2A③	1NO-1NC (11)	HW-CNP11
	2NO (20)	HW-CNP20
	2NO-2NC (22N1)	HW-CNP22N1
HW1R-2D③	2NO (20)	HW-CNP20
	2NO-2NC (22)	HW-CNP22
HW1R-2E③	2NO-2NC (22)	HW-CNP22
HW1R-2F③	2NO-2NC (22)	HW-CNP22
HW1R-2N③	2NO-2NC (22N2)	HW-CNP22N2
HW1R-2T③	2NO-2NC (22)	HW-CNP22

- On the contact arrangement marked with ★ in the table above, the rated load switching current is reduced to a half of the related current of the contact block. The rated insulation voltage and the rated thermal current remain unchanged.
- For models with ☆, contacts may overlap when the operator position is changed.
- When operating the pushbutton selector, do not turn the operator ring or the lock lever while the button is depressed. Otherwise the pushbutton selector may be damaged.
- For contact mounting position, see page 51.

For Part No. (Ordering No.)/ mounting positions of contact units, see page 51.

Momoloever switches can be purchased only as a sub-assembled product.

Monolever Switches

Sub-Assembled

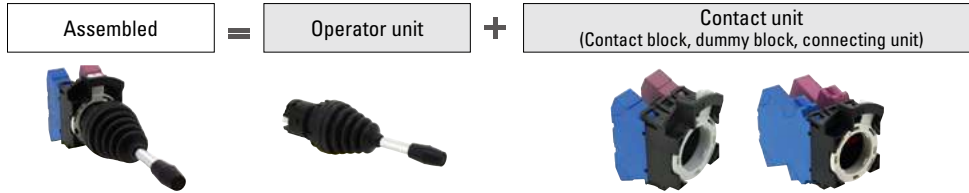

When ordering, specify the sub-assembled ordering no.





Sub-Assembled Ordering No.

Package Quantity: 1

Name / Shape	Positions	<Reference> Assembled Part No.
HW1M Standard 	2-position	HW1M-P1010-20
		HW1M-P2020-20
		HW1M-P0101-20
		HW1M-P0202-20
		HW1M-P0101-40
		HW1M-P0202-40
	4-position	HW1M-P1111-22N9
		HW1M-P2222-22N9
HW1M-L Interlocking 	2-position	HW1M-LP1010-20
		HW1M-LP2020-20
		HW1M-LP0101-20
		HW1M-LP0202-20
		HW1M-LP0101-40
		HW1M-LP0202-40
	4-position	HW1M-LP1111-22N9
		HW1M-LP2222-22N9

Operator unit	
Name / Shape	Part No. (Ordering No.)
HW1M Standard 	HW1M-1010
	HW1M-2020
	HW1M-0101
	HW1M-0202
	HW1M-0101
	HW1M-0202
	HW1M-1111
	HW1M-2222
HW1M-L Interlocking 	HW1M-L1010
	HW1M-L2020
	HW1M-L0101
	HW1M-L0202
	HW1M-L0101
	HW1M-L0202
	HW1M-L1111
	HW1M-L2222

Contact unit		
Shape	Contact Configuration	Part No. (Ordering No.)
	2NO (20)	HW-CNP20
	4NO (40)	HW-CNP40
	2NO-2NC (22)	HW-CNP22
	2NO (20)	HW-CNP20
	4NO (40)	HW-CNP40
	2NO-2NC (22)	HW-CNP22

• On all mono-lever switches, the rated current (load switching current) is reduced to a half of the rated current of the contact block. The rated insulation voltage and the rated thermal current remain unchanged.

• For contact mounting position, see page 51.

For Part No. (Ordering No.)/ mounting positions of contact units, see page 51.

Monolever Switches

Contact Configuration

2-position (Right/Left)

Contact Code	Contact Block		Lever Operator Position			
	Mounting Position	Contact	Left	Center	Right	
20	(1)	NO	X			
	(3)	NO			X	
40	(1)	2NO	NO	X		
			NO	X		
	(3)	2NO	NO			X
			NO			X

2-position (Up/Down)

Contact Code	Contact Block		Lever Operator Position			
	Mounting Position	Contact	Down	Center	Up	
20	(1)	NO	X			
	(3)	NO			X	
20	(1)	2NO	NO	X		
			NO	X		
	(3)	2NO	NO			X
			NO			X

Contact Code	Contact Block		Lever Operator Position					
	Mounting Position	Contact	Down	Left	Center	Up	Right	
22	(1)	NONC			X			
			NC					X
	(3)	NONC	NO				X	
			NC	X				

Contact Block Mounting Position

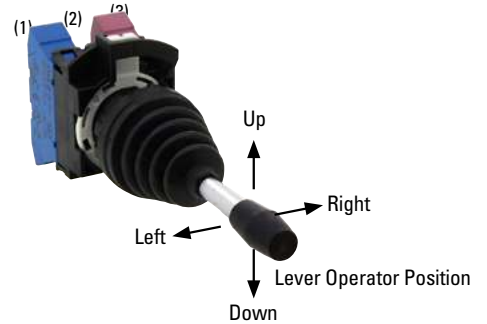

Note) (2) can only be mounted with a dummy block.

Note) The lever operator of the interlocking type HW1M-L is locked only in the center position. Pull on the interlocking lever before operating the lever up/down/right/left.

Monolever Switches Part No. Example

Assembled and sub-assembled unit

Assembled Part No. Example

HW1M-L P 1 0 1 0 - 20
Up Right Down Left

- ① Model
HW1M: Standard
HW1M-L: Interlocking
- ② Lever operation mode
Order of Entry
Up - Right - Down - Left
1: Maintained
2: Spring returned
0: Blocked
- ③ Contact configuration code
Select a required contact operation at each lever operator position from the contact arrangement charts above and specify the Contact Code.

• For available assembled products, see table on page 41.

Operator unit

HW1M-L 1 0 1 0
Up Right Down Left

- ① Model
HW1M: Standard
HW1M-L: Interlocking
- ② Lever operation mode
Order of Entry
Up - Right - Down - Left
1: Maintained
2: Spring returned
0: Blocked

Contact unit

HW- CN P 1 0 20

- ③ Contact configuration code
Select a required contact operation at each lever operator position from the contact arrangement charts above and specify the Contact Code.

Dimensions

Standard

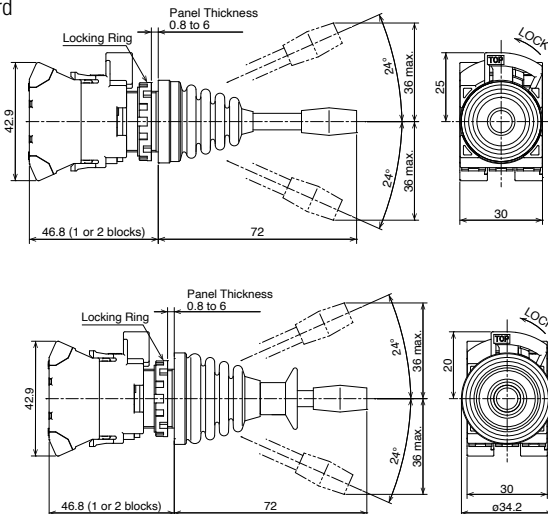

Interlocking

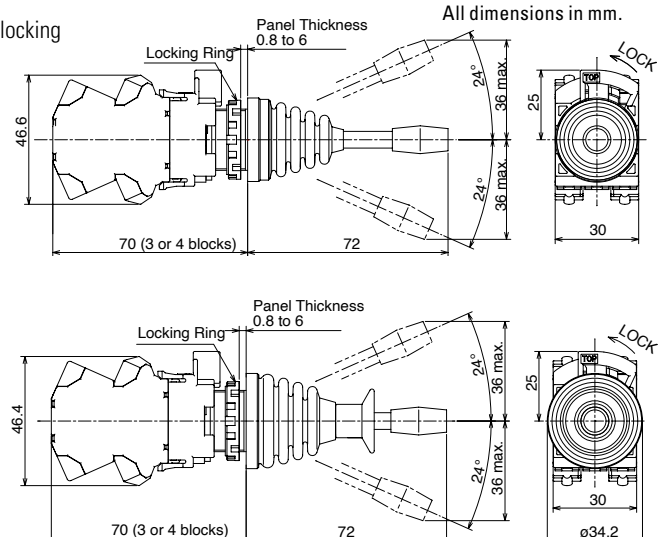



Short Body Pilot Lights

Assembled



Package Quantity: 1

Name / Shape	Operating Voltage	Part No. (Ordering No.)	① Lens Color Code
Extended (Dome) HW1P 	6V AC/DC	HW1P-2JPQ2①	R (red) G (green) Y (yellow) A (amber) S (blue) PW (Pure white)
	12V AC/DC	HW1P-2JPQ3①	
	24V AC/DC	HW1P-2JPQ4①	
	100/120V AC/DC	HW1P-2JPRH2①	
	200/240V AC/DC	HW1P-2JPCM2①	
Square Flush HW2P 	6V AC/DC	HW2P-1JPQ2①	R (red) G (green) Y (yellow) A (amber) S (blue) PW (Pure white)
	12V AC/DC	HW2P-1JPQ3①	
	24V AC/DC	HW2P-1JPQ4①	
	100/120V AC/DC	HW2P-1JPRH2①	
	200/240V AC/DC	HW2P-1JPCM2①	

- Built-in BA9S base LED lamp. See page 57 for LED Lamps.
- For square flush pilot lights, legends and symbols can be engraved on marking plates, or printed film can be inserted. For details on marking plates or film, see page 63. Engraving and films must be prepared by the customer.
- Specify a lens color code in place of ① in the Part No.

Short Body Pilot Lights

Dimensions

All dimensions in mm.

Extended (Dome)
6V, 12V, 24V AC/DC

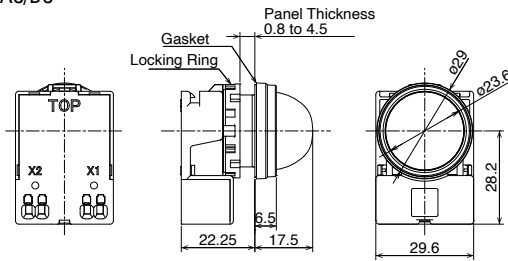

100/120V AC/DC, 200/240V AC

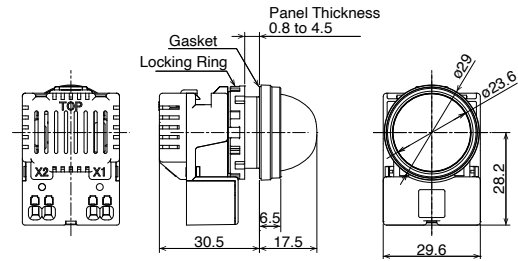

Square Flush
6V, 12V, 24V AC/DC

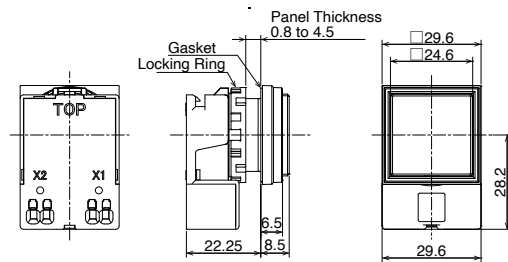

100/120V AC/DC, 200/240V AC

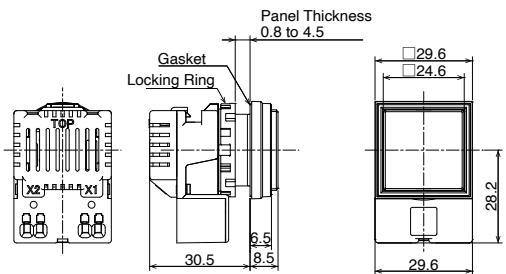

Illuminated / Non-Illuminated Buzzers



Easy installation of buzzers and lamps

- Short, 19.7 mm depth behind panel.
- Buzzer and lamp functions are integrated. (Illuminated buzzers)
- IP65 waterproof from the front of the panel
- Installing an optional terminal rubber boot upgrades the terminal's waterproof characteristics to IP54 without the need to use a rear enclosure.



• See website for details on approvals and standards.

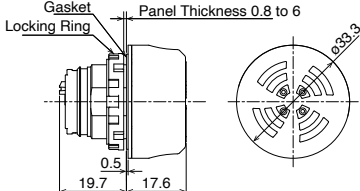

Name / Shape	Part No. (Ordering No.)	Illumination Color	Sound Type	Package Quantity	Dimensions (All dimensions in mm.)
 Illuminated Buzzer	HW1Z-P1F2PQ4R	Red	Intermittent	1	
	HW1Z-P1F2PQ4Y	Yellow			
 Non-Illuminated Buzzer	HW1Z-2PQ4B	—	Steady	1	
	HW1Z-F2PQ4B	—	Intermittent		

• See page 54 for details on terminal rubber boot.

Specifications and Ratings

Rated Insulation Voltage	30V	
Rated Voltage	12 to 24V DC	
Voltage Range	10.8 to 26.4V DC	
Rated Current (effective value)	Illuminated: 18mA (24V DC), 8mA (12V DC) Non-Illuminated (Steady sound): 9mA (24V DC), 4mA (12V DC) (Intermittent sound): 7mA (24V DC), 3mA (12V DC)	
Inrush Current	100mA maximum	
Buzzer	Sound Pressure (of HW1Z itself) (at 25°C)	90dB min. at 0.1m (24VDC) 70dB min. at 1m (24V DC, equivalent value) 84dB min. at 0.1m (12V DC) 64dB min. at 1m (12VDC, equivalent value)
	Sound Frequency (at 25°C)	2,200 to 2,450Hz
	Sound Type	Illuminated: Intermittent Non-Illuminated: Steady/Intermittent
	Intermittent Cycle (at 25°C)	105 cycles/minute approx. (1.75Hz approx.)
Illumination	Illumination Type	Flashing
	Flash Cycle (at 25°C)	105 cycles/minute approx. (1.75Hz approx.)
Operating Temperature	-20 to +50°C (no freezing)	
Operating Humidity	20 to 85% RH (no condensation)	
Storage Temperature	-30 to +80°C (no freezing)	
Insulation Resistance	100 MΩ minimum (500V DC megger)	
Dielectric Strength	Between live and earthed metal parts: 1000 AC, 1 minute	
Vibration Resistance	Damage limits: 5 to 55Hz, amplitude 0.5 mm Operating extremes: 5 to 55Hz, amplitude 0.5 mm	
Shock Resistance	Operating extremes: 100 m/s ² Damage limits: 1,000 m/s ²	
Degree of Protection	Panel front	IP65 (IEC60529)
	Terminal	IP40 (IEC 60529) IP54 (with terminal rubber boot) (IEC 60529)
Terminal Style	Push-in terminal	
Applicable Wire	Solid wire/ferrule (without insulation cover): 0.2 to 1.5 mm ² , AWG24-16 Ferrule (with insulation cover): 0.2 to 0.75 mm ² , AWG24-18	
Weight (approx.)	17g	

Dimensions

All dimensions in mm.

With terminal rubber boot

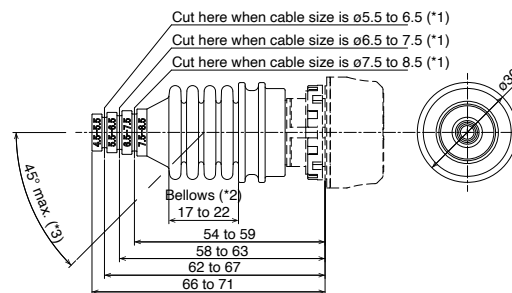

- *1: ø4.5-5.5 cable needs no cutting.
- *2: The bellows must be 17 to 22mm long after installing the terminal rubber boot.
- *3: Maintain a cable angle of 45° max. to the HW1Z axis.

Terminal Arrangement (bottom view)

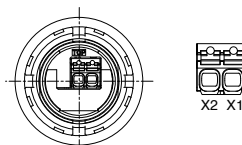

X1 and X2 have no polarity.

Mounting Hole Layout

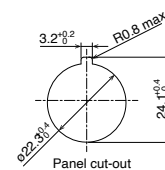

3.2ø2 hole is for anti-rotation. Not required when nameplate/anti-rotation is not used.

Instructions for Illuminated / Non-illuminated buzzers: see page 66

Emergency Stop Switches

Emergency Stop Switches

- Direct opening action (IEC 60947-5-5; 5.2, IEC 60947-5-1; Annex K)
- Safety lock mechanism (IEC 60947-5-5; 6.2)
- Degree of Protection IP65 (IEC 60529)



• See website for details on approvals and standards.

Specifications

Operating Temperature	-25 to +60°C (no freezing)	
Operating Humidity	45 to 85% RH (no condensation)	
Storage Temperature	-40 to +80°C (no freezing)	
Minimum Force Required for Direct Opening Action	80N	
Minimum Operator Stroke Required for Direct Opening Action	5.5mm	
Maximum Operator Stroke	10.0mm	
Contact Resistance	50 mΩ maximum (initial value)	
Insulation Resistance	100 MΩ minimum (500V DC megger)	
Dielectric Strength	Between live and dead parts: 2500V AC, 1 minute Between terminals of different poles: 2500V AC, 1 minute Between terminals of the same poles: 2500V AC, 1 minute	
Vibration Resistance	Damage limits	10 to 500 Hz, Amplitude 0.35 mm, Acceleration 50m/s ²
	Operating extremes	10 to 500 Hz, Amplitude 0.35 mm, Acceleration 50m/s ²
Shock Resistance	Damage limits: 1,000 m/s ² Operating extremes: 150 m/s ²	
Operation Frequency	900 operations/hour	
Life	Mechanical	Single contact block: 100,000 operations minimum Double contact block: 50,000 operations minimum
	Electrical	Single contact block: 100,000 operations minimum Double contact block: 50,000 operations minimum (at 900 operations/h, duty ratio 40%)
Degree of Protection	IP65 (IEC 60529), UL Type 4X	
Short-circuit Protection	250V/10A fuse (Type aM IEC 60269-1/IEC 60269-2)	
Weight (approx.)	51g (HW1B-V4P02) 67g (HW1B-V4P04) 48g (HW1B-Y2P02)	

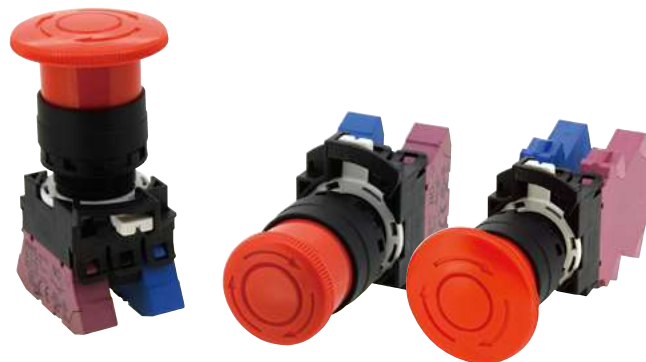

Mounting Hole Layout

All dimensions in mm.

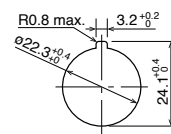

Minimum Mounting Centers for HW1B (emergency stop switch)

	Vertical Spacing	Horizontal Spacing
HW1B-V3 HW1B-V4 HW1B-Y2	50 mm minimum	50 mm minimum
HW1B-V5	60 mm minimum	60 mm minimum

- The minimum mounting centers of HW1B (pushbuttons) and each HW series emergency stop switches are shown. For other button shapes, refer to the dimensions and take wiring and operation of switches into consideration.

Nameplate (for ø22 mm Emergency Stop Switches)

Package Quantity: 1

Shape	Legend	Part No.	Ordering No.	Remarks
	(blank)	HWAV-0-Y	HWAV-0-Y	HWAV-27-Y Nameplate color: yellow Legend color: black Panel thickness: 0.8 to 4.5 mm Material: Polyamide Note) Cannot be used on ø60 mushroom pushlock turn reset switches. Use a nameplate exclusive for ø60 mushroom e-stop. See XW series catalog.
	EMERGENCY STOP	HWAV-27-Y	HWAV-27-Y	

- "EMERGENCY OFF" and white (blank) nameplates available. See website or catalog for SEMI Emergency off (EMO) switches and Stop switches.

Note) For machinery subject to ISO/IEC standards such as machine tools and food machinery, in compliant with the revised ISO13850, it is not recommended to display texts or symbols such as EMERGENCY STOP on the actuator or nameplate of an emergency stop device.

Emergency Stop Switches

Assembled



Package Quantity: 1

Name / Shape	Contact Configuration	Part No. (Coded)
 ø29mm Mushroom Pushlock Turn Reset HW®B-V3	1NC	HW®B-V3P01R
	1NO-1NC	HW®B-V3P11R
	2NC	HW®B-V3P02R
	3NC	HW®B-V3P03N2R
	1NO-1NC	HW®B-V3P22R
	4NC	HW®B-V3P04R

Package Quantity: 1

Name / Shape	Contact Configuration	Part No. (Coded)
 ø40mm Mushroom Pushlock Turn Reset HW1B-V4 HW4B-V4	1NC	HW®B-V4P01R
	1NO-1NC	HW®B-V4P11R
	2NC	HW®B-V4P02R
	3NC	HW®B-V4P03N2R
	1NO-1NC	HW®B-V4P22R
	4NC	HW®B-V4P04R

- Pushlock turn reset – Button is maintained when pressed and is reset when turned clockwise.
- Emergency stop switches with 1 contact block contain 2 dummy blocks. Pushbuttons with 2 contact block contains 1 dummy block.

• For other specifications, select from sub-assembled units (page 48).

Part No. Example

Assembled and sub-assembled unit

Assembled Part No. Example

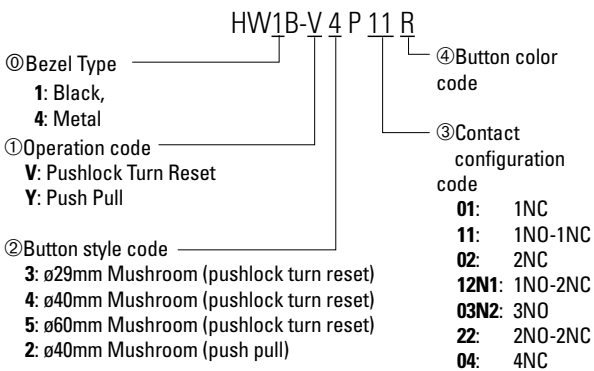

- For available assembled products, see table above.

Note

- For emergency stop purposes, these switches must contain at least one NC contact block.

Sub-assembled operator unit

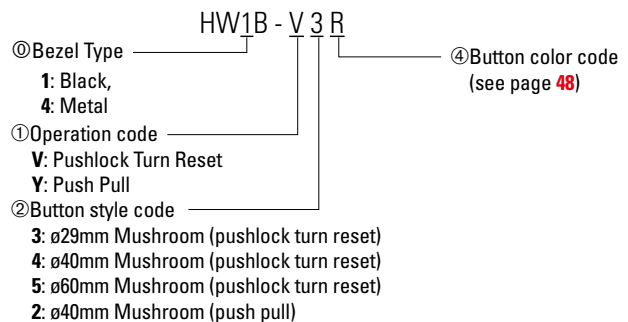

Sub-assembled contact unit

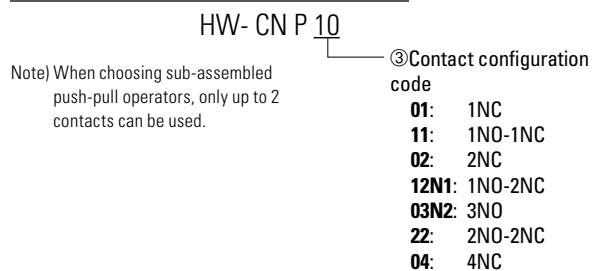



Emergency Stop Switches

Sub-Assembled

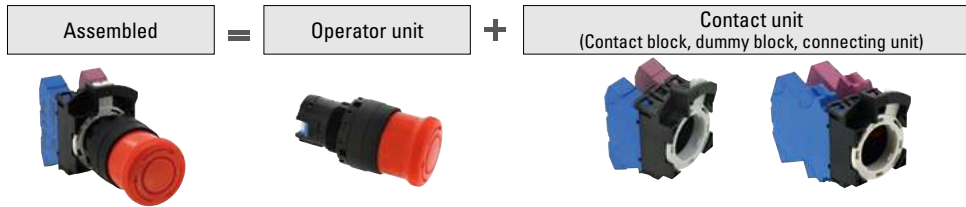
When ordering, specify the sub-assembled ordering no. See page 47 for available assembled products.



Pushlock Turn Reset

Name / Shape	Contact Configuration	<Reference> Assembled Part No. ④ = 1 or 4	④ Button Color Code
 ø29mm Mushroom HW@B-V3	1NC	HW@B-V3P01④	R (red) Y (yellow)
	1NO-1NC	HW@B-V3P11④	
	2NC	HW@B-V3P02④	
	1NO-2NC	HW@B-V3P12N1④	
	3NC	HW@B-V3P03N2④	
	2NO-2NC	HW@B-V3P22④	
 ø40mm Mushroom HW@B-V4	1NC	HW@B-V4P01④	R (red) Y (yellow)
	1NO-1NC	HW@B-V4P11④	
	2NC	HW@B-V4P02④	
	1NO-2NC	HW@B-V4P12N1④	
	3NC	HW@B-V4P03N2④	
	2NO-2NC	HW@B-V4P22④	
 ø60mm Mushroom HW@B-V5	1NC	HW@B-V5P01④	R (red) Y (yellow)
	1NO-1NC	HW@B-V5P11④	
	2NC	HW@B-V5P02④	
	1NO-2NC	HW@B-V5P12N④	
	3NC	HW@B-V5P03N2④	
	2NO-2NC	HW@B-V5P22④	

- Pushlock turn reset – Button is maintained when pressed and is reset when turned clockwise.

Sub-assembled Ordering No. Pushlock Turn Reset

Package Quantity: 1

Operator Unit		Contact Unit		
Name / Shape	Part No. (Ordering No.)	Shape	Contact Configuration	Part No. (Ordering No.)
 ø29mm Mushroom	HW@B-V3④		1NC	HW-CNP01
			1NO-1NC	HW-CNP11
			2NC	HW-CNP02
			1NO-2NC	HW-CNP12N1
			3NC	HW-CNP03N2
			2NO-2NC	HW-CNP22
 ø40mm Mushroom	HW@B-V4④		1NC	HW-CNP01
			1NO-1NC	HW-CNP11
			2NC	HW-CNP02
			1NO-2NC	HW-CNP12N1
			3NC	HW-CNP03N2
			2NO-2NC	HW-CNP22
 ø60mm Mushroom	HW@B-V5④		1NC	HW-CNP01
			1NO-1NC	HW-CNP11
			2NC	HW-CNP02
			1NO-2NC	HW-CNP12N1
			3NC	HW-CNP03N2
			2NO-2NC	HW-CNP22

- Specify a button color code in place of ④ in the Part No. R (red), Y (yellow)
Note) Y (yellow) cannot be used as an emergency stop switch by EN standards.



Push Pull

Name / Shape	Contact Configuration	<Reference> Assembled Part No. ④	④ Button Color Code
 ø40mm Mushroom HW1B-Y2	1NC	HW@B-Y2P01④	R (red) Y (yellow)
	1NO-1NC	HW@B-Y2P11④	
	2NC	HW@B-Y2P02④	

- Push-Pull – 2-position switches with button maintained in both depressed and reset positions.
- Bezel Type: 1: Black, 4: Metal

Push Pull

Package Quantity: 1

Operator Unit		Contact Unit		
Name / Shape	Part No. (Ordering No.)	Shape	Contact Configuration	Part No. (Ordering No.)
 ø40mm Mushroom	HW@B-Y2④		1NC	HW-CNP01
			1NO-1NC	HW-CNP11
			2NC	HW-CNP02

- Specify a button color code in place of ④ in the Part No. R (red), Y (yellow)
Note) Y (yellow) cannot be used as an emergency stop switch by EN standards.
Note) Only up to 2 contacts can be used for push-pull switches.

For Part No. (Ordering No.)/ mounting positions of contact units, see page 51.

Emergency Stop Switches Dimensions

All dimensions in mm.

Dimensions

All dimensions in mm.

ø29mm Mushroom Pushlock Turn Reset

HW1B-V3

1 to 2 contacts

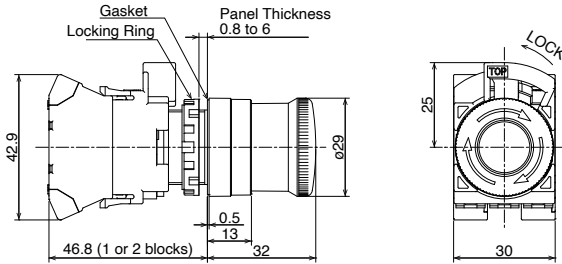

3 to 4 contacts

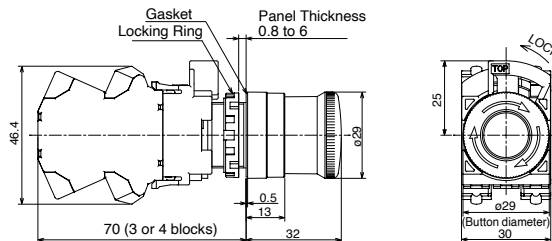

ø29mm Mushroom Pushlock Turn Reset

HW1B-V4

1 to 2 contacts

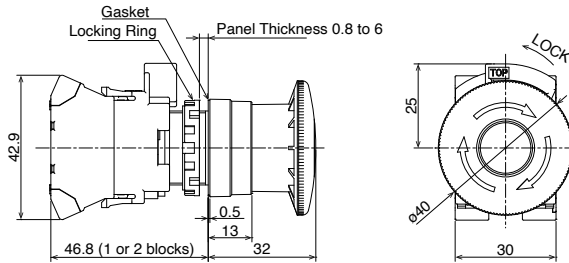

3 to 4 contacts

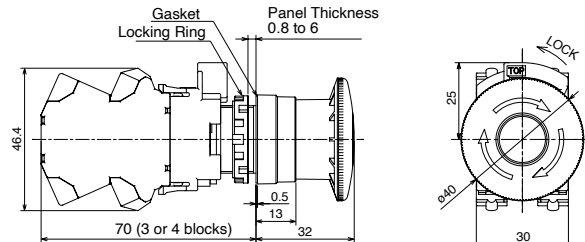

ø60mm Mushroom Pushlock Turn Reset

HW1B-V5

1 to 2 contacts

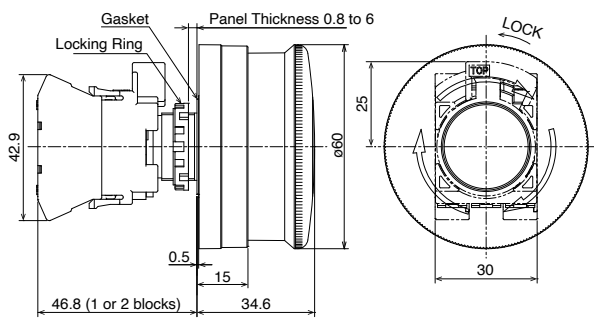

3 to 4 contacts

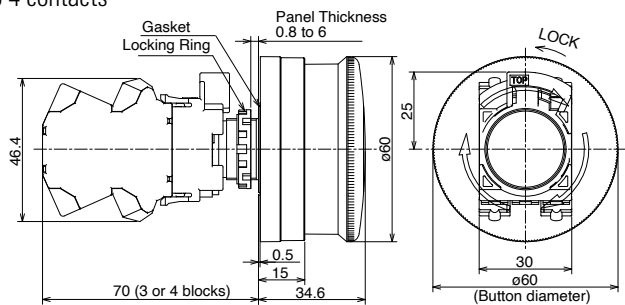

ø40mm Mushroom Push Pull (2-position)

HW1B-Y2

1 to 2 contacts

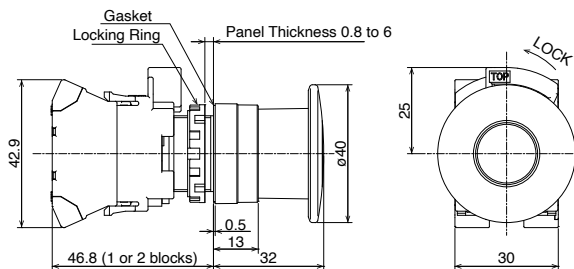

Nameplates

All dimensions in mm

When ordering, specify the Ordering No.

Description		Material	Part No.	Ordering No.	Dimensions (mm)
Legend					
HWAM	Order marking plate (round) separately.	Plastic (black)	HWAM	HWAM	HWNP-□ marking plate (sold separately) is necessary.
				HWAMPN10	
HWAQ	Order marking plate (square) separately.	Plastic (black)	HWAQ	HWAQ	HWNP-□ marking plate (sold separately) is necessary.
				HWAQPN10	
HWAS	Blank	Plastic (black)	HWAS-0	HWAS-0	
				HWAS-0PN10	

Marking Plates for HWAM/HWAQ

When ordering, specify the Ordering No.

Description	Material	Part No.	Ordering No.	Dimensions (mm)
HWNP	Aluminum (black) Thickness = 1.0mm	HWNP-□	HWNP-□	White legend on black background. Engraving area: W25×H7
			HWNP-□PN10	

- Specify a legend code in place of □ in the Ordering No.

Legends

Code	Legend
0	(blank)
1	ON
2	OFF
3	START
4	STOP
31	OFF-ON
35	HAND-AUTO
53	HAND-OFF-AUTO

- See page 63 for how to install nameplates/marketing plates, and how to remove marking plates.

E-Stop Shrouds

Style	Part Numbers	E-Stop Types	Applicable Standards
	HW9Z-KG1	40mm Mushroom Head	SEMI S2-0703, 12.5.1 Compliant
	HW9Z-KG2	40mm Mushroom Head	SEMI S2-0703, 12.5.1 & SEMATECH Compliant

Style	Part Numbers	E-Stop Types	Applicable Standards
	HW9Z-KG3	40mm Mushroom Head	SEMI S2 Compliant (Approved by TUV) ISO 13850
	HW9Z-KG4	40mm Mushroom Head	SEMI S2 Compliant (Approved by TUV) & SEMATECH ISO 13850

Contact Unit

Contact Unit Part No. / Contact Configuration

Package Quantity: 1

Shape / Contact Block Mounting Position

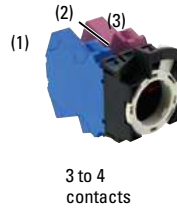
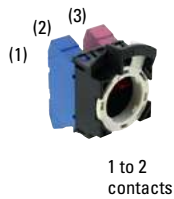

Note) (2) can only be mounted with a dummy block.

Contact Configuration (Code)	Part No. (Ordering No.)	Mounting Position	Contact	Component Part No.
1NO (10)	HW-CNP10	(1)	1NO	HW-P10
		(2)	Dummy	CW-DB
		(3)	Dummy	CW-DB
1NC (01)	HW-CNP01	(1)	Dummy	CW-DB
		(2)	Dummy	CW-DB
		(3)	1NC	HW-P01
1NO-1NC (11)	HW-CNP11	(1)	1NO	HW-P10
		(2)	Dummy	CW-DB
		(3)	1NC	HW-P01
1NO-1NC (11N1)	HW-CNP11N1	(1)	1NC	HW-P01
		(2)	Dummy	CW-DB
		(3)	1NO	HW-P10
2NO (20)	HW-CNP20	(1)	1NO	HW-P10
		(2)	Dummy	CW-DB
		(3)	1NO	HW-P10
2NC (02)	HW-CNP02	(1)	1NC	HW-P01
		(2)	Dummy	CW-DB
		(3)	1NC	HW-P01
2NO-2NC (22)	HW-CNP22	(1)	1NO-1NC	HW-PW11
		(2)	Dummy	CW-DB
		(3)	1NO-1NC	HW-PW11
2NO-2NC (22N1)	HW-CNP22N1	(1)	2NO	HW-PW20
		(2)	Dummy	CW-DB
		(3)	2NC	HW-PW02
2NO-2NC (22N2)	HW-CNP22N2	(1)	2NC	HW-PW02
		(2)	Dummy	CW-DB
		(3)	2NO	HW-PW20

Contact Configuration (Code)	Part No. (Ordering No.)	Mounting Position	Contact	Component Part No.
3NO (30N1)	HW-CNP30N1	(1)	2NO	HW-PW20
		(2)	Dummy	CW-DB
		(3)	1NO	HW-P10
3NC (03N2)	HW-CNP03N2	(1)	2NC	HW-PW02
		(2)	Dummy	CW-DB
		(3)	1NC	HW-P01
1NO-2NC (12N1)	HW-CNP12N1	(1)	1NO-1NC	HW-PW11
		(2)	Dummy	CW-DB
		(3)	1NC	HW-P01
1NO-3NC (13)	HW-CNP13	(1)	1NO-1NC	HW-PW11
		(2)	Dummy	CW-DB
		(3)	2NC	HW-PW-02
2NO-1NC (21N3)	HW-CNP21N3	(1)	1NO-1NC	HW-PW11
		(2)	Dummy	CW-DB
		(3)	1NO	HW-P10
3NO-1NC (31)	HW-CNP31N1	(1)	1NO-1NC	HW-PW11
		(2)	Dummy	CW-DB
		(3)	2NO	HW-PW20
1NO-3NC (13)	HW-CNP13	(1)	1NO-1NC	HW-PW11
		(2)	Dummy	CW-DB
		(3)	2NC	HW-PW02
4NO (40)	HW-CNP40	(1)	2NO	HW-PW20
		(2)	Dummy	CW-DB
		(3)	2NO	HW-PW20
4NC (04)	HW-CNP04	(1)	2NC	HW-PW02
		(2)	Dummy	CW-DB
		(3)	2NC	HW-PW02

- Contact unit includes a contact block(s), and a connecting unit.
- Switches with 1 contact block contain 2 dummy blocks. Switches with 2 contact blocks contain 1 dummy block.

Contact Unit

Contact Unit (illuminated) Part No. / Contact Configuration

Package Quantity: 1

Shape / Contact Block Mounting Position

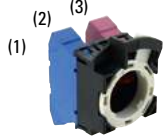

1 to 2 contacts

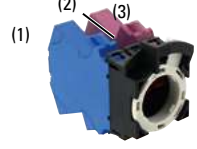

3 to 4 contacts

Note) (2) can only be mounted with a dummy block.

Contact Configuration (Code)	Part No. (Ordering No.)	Mounting Position	Contact	Component Part No.
1NO (10)	HW-CNP10Q0	(1)	1NO	HW-P10
		(2)	Full voltage adapter	HW-DP
		(3)	Dummy	CW-DB
1NC (01)	HW-CNP01Q0	(1)	Dummy	CW-DB
		(2)	Full voltage adapter	HW-DP
		(3)	1NC	HW-P01
1NO-1NC (11)	HW-CNP11Q0	(1)	1NO	HW-P10
		(2)	Full voltage adapter	HW-DP
		(3)	1NC	HW-P01
1NO-1NC (11N1)	HW-CNP11N1Q0	(1)	1NC	HW-P01
		(2)	Full voltage adapter	HW-DP
		(3)	1NO	HW-P10
2NO (20)	HW-CNP20Q0	(1)	1NO	HW-P10
		(2)	Full voltage adapter	HW-DP
		(3)	1NO	HW-P10
2NC (02)	HW-CNP02Q0	(1)	1NC	HW-P01
		(2)	Full voltage adapter	HW-DP
		(3)	1NC	HW-P01
2NO-2NC (22)	HW-CNP22Q0	(1)	1NO-1NC	HW-PW11
		(2)	Full voltage adapter	HW-DP
		(3)	1NO-1NC	HW-PW11
2NO-2NC (22N1)	HW-CNP22N1Q0	(1)	2NO	HW-PW20
		(2)	Full voltage adapter	HW-DP
		(3)	2NC	HW-PW02
2NO-2NC (22N2)	HW-CNP22N2Q0	(1)	2NC	HW-PW02
		(2)	Full voltage adapter	HW-DP
		(3)	2NO	HW-PW20

Contact Configuration (Code)	Part No. (Ordering No.)	Mounting Position	Contact	Component Part No.
3NO (30N1)	HW-CNP30N1Q0	(1)	2NO	HW-PW20
		(2)	Full voltage adapter	HW-DP
		(3)	1NO	HW-P10
3NC (03N2)	HW-CNP03N2Q0	(1)	2NC	HW-PW02
		(2)	Full voltage adapter	HW-DP
		(3)	1NC	HW-P01
1NO-2NC (12N1)	HW-CNP12N1Q0	(1)	1NO-1NC	HW-PW11
		(2)	Full voltage adapter	HW-DP
		(3)	1NC	HW-P01
1NO-3NC (13)	HW-CNP13Q0	(1)	1NO-1NC	HW-PW11
		(2)	Full voltage adapter	HW-DP
		(3)	2NC	HW-PW02
2NO-1NC (21N3)	HW-CNP21N3Q0	(1)	1NO-1NC	HW-PW11
		(2)	Full voltage adapter	HW-DP
		(3)	1NO	HW-P10
3NO-1NC (31)	HW-CNP31Q0	(1)	1NO	HW-P10
		(2)	Full voltage adapter	HW-DP
		(3)	1NO-1NC	HW-PW11
1NO-3NC (13)	HW-CNP13Q0	(1)	1NO-1NC	HW-PW11
		(2)	Full voltage adapter	HW-DP
		(3)	2NC	HW-PW02
4NO (40)	HW-CNP40Q0	(1)	2NO	HW-PW20
		(2)	Full voltage adapter	HW-DP
		(3)	2NO	HW-PW20
4NC (04)	HW-CNP04Q0	(1)	2NC	HW-PW02
		(2)	Full voltage adapter	HW-DP
		(3)	2NC	HW-PW02

- Contact unit (illuminated) includes a contact block(s), full voltage adapter, and a connecting unit.
- Switches with 1 contact block contain 2 dummy blocks. Switches with 2 contact blocks contain 1 dummy block.











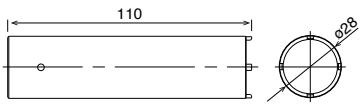

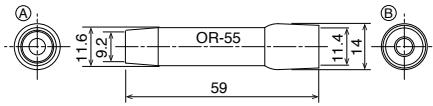

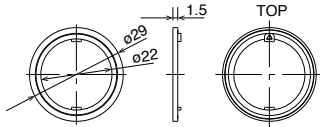
Note) LED lamp is not installed. When ordering a contact unit (illuminated), select a LED lamp from below.

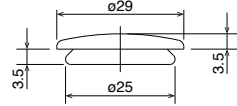
LED lamp (package quantity:1)	
	
Rated Voltage	Part No. (Ordering No.)
6V AC/DC	LSRD-6
12V AC/DC	LSRD-1
24V AC/DC	LSRD-2
100/120V AC/DC	LSRD-H2
200/220V AC	LSRD-M2
230/240V AC	LSRD-M4

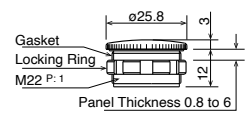
Accessories

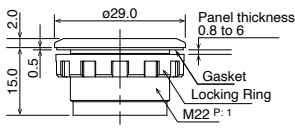
All dimensions in mm

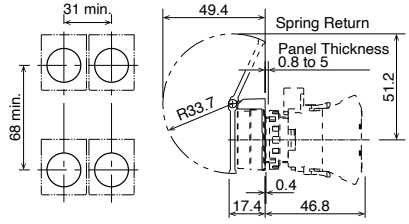

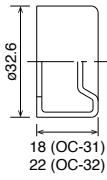



When ordering, specify the Ordering No.

Name / Shape		Material	Part No.	Remarks
Tool	Locking Ring Wrench 	Metal (nickel-plated brass) Weight: approx. 150g	MW9Z-T1	<ul style="list-style-type: none"> Used to tighten the locking ring when installing the HW switch onto a panel. 
	Lamp Holder Tool 	Nitrile rubber (black)	OR-55	<ul style="list-style-type: none"> Used to install and remove the LED lamps. See page 59 for how to install. Ⓐ : BA9S 
Anti-rotation Ring 		Ring: polyamide Gasket: nitril rubber	HW9Z-RL	<ul style="list-style-type: none"> Used to prevent the operator from turning. Generally used when using no nameplates on selector switches and pushbutton selectors. 
Rubber Mounting Hole Plug 		Nitril rubber (black)	OB-31	<ul style="list-style-type: none"> Degree of protection: IP65 (round hole), IP40 (with anti-rotation function) 
Mounting Hole Plug 		Plug: Metal (Zinc diecast) Locking nut: Polyamide Gasket: Nitrile rubber	LW9Z-BM	<ul style="list-style-type: none"> Degree of protection: IP66 (round hole), IP40 (with anti-rotation function) Tightening torque: 1.2 N·m 
Mounting Hole Plug 		Polyamide	LW9Z-BP1	<ul style="list-style-type: none"> Degree of protection: IP65 Tightening torque: 2.0 N·m 
Switch Guard 	Spring Return	Guard: Polyacetal Cover: polyarylate	HW9Z-K1	<ul style="list-style-type: none"> Used to prevent inadvertent operation for flush pushbuttons. Degree of protection: IP65 Maintained type stops at 90° and 180°. 
	Maintained	Gasket: Nitrile rubber	HW9Z-K11	
Button Clear Boot 	For flush pushbuttons	Rubber (EPDM)	OC-31	<ul style="list-style-type: none"> Used to cover and protect pushbuttons where units are subject to watersplash. Not suitable for outdoor use or where the units are subject to oil splash. Cannot be used with nameplates HWAM, HWAQ, HWAS, or HWAV. 
	For extended pushbuttons		OC-32	

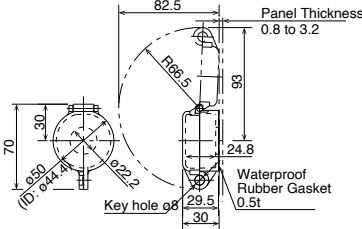
Accessories

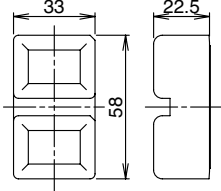
All dimensions in mm





When ordering, specify the Ordering No.

Name / Shape	Material	Part No.	Remarks
<p>Padlock Cover</p> 	<p>Polyarylate</p> <p>Gasket: Nitrile rubber</p>	<p>HW9Z-KL1</p>	<ul style="list-style-type: none"> Used to protect pushbuttons, selector switches, and key selector switches. 
<p>Rubber Boot for Dual Pushbutton Switches</p> 	<p>Clear Silicon Rubber</p>	<p>HW9Z-D7D</p>	<ul style="list-style-type: none"> IP65 
<p>Ring Adapter</p> 	<p>Nitril rubber</p>	<p>HW9Z-A25</p>	<ul style="list-style-type: none"> Used to install the HW series units into ø25 mm mounting holes. Degree of protection: IP65 Cannot be used with anti-rotation and nameplate. Mounting panel thickness: 1.2 to 6.0 mm See page 62 for details.
<p>Ring Adapter</p> 	<p>Gasket: polyamide</p> <p>Washer: metal (brass)</p>	<p>HW9Z-A30</p>	<ul style="list-style-type: none"> Used to install the HW series units (round type) into ø30 mm mounting holes (except HW1P-5, HW1E, HW1B-M5/V5, HW7D). Degree of protection: IP65 Cannot be used with anti-rotation ring and nameplate. Cannot be used on full shroud illuminated pushbuttons, selector pushbuttons, and mono-lever switches. Mounting panel thickness: 1.6 to 4.0 mm
<p>For Illuminated Buzzer Terminal Rubber Boot</p> 	<p>Nitrile rubber</p>	<p>HW9Z-CZ1</p>	<ul style="list-style-type: none"> Applicable cable: ø4.5 to 8.5 mm Cut the end of rubber boot to fit the cable size (see dimensions on page 66). Weight: 10 g (approx.)

Accessories

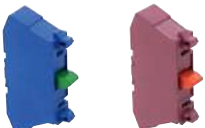
All dimensions in mm

When ordering, specify the Ordering No.





Name / Shape	Material	Part No.	Remarks
Contact Block 	NO contact Housing color: blue	HW-P10	Terminal no.: 1st deck 3-4
	NC contact Housing color: reddish purple	HW-P01	Terminal no.: 1st deck: 1-2
	NO (Early Make) contact Housing color: blue / black	HW-P10R	Terminal no.: 1st deck: 1-2
	2NO contact Housing color: blue	HW-PW20	Terminal no.: 1 deck: 13-14 2 deck: 23-24
	2NC contact Housing color: reddish purple	HW-PW02	Terminal no.: 1 deck: 11-12 2 deck: 21-22
	NONC contact Housing color: blue / reddish purple	HW-PW11	Terminal no.: 1 deck: 13-14 2 deck: 21-22
	NONC (Early Make)contact Housing color: blue / reddish purple	HW-PW1R1	Terminal no.: 1 deck: 13-14 2 deck: 21-22
	2NO (Early Make) contact Housing color: blue / black	HW-PW2R0	Terminal no.: 1 deck: 13-14 2 deck: 21-22
Full voltage adapter 	Nylon (black)	HW-DP	Terminal No: X1, X2
	Connecting unit 	Weight: approx. 9g	HW-CNP
Dummy Block 	Polyamide (black)	CW-DB	Note) Switches with 1 contact block contain 2 dummy blocks. Switches with 2 contact blocks contain 1 dummy block.

Note) Switches with 1 contact block contain 2 dummy blocks. Switches with 2 contact blocks contain 1 dummy block.

Maintenance Parts

All dimensions in mm





When ordering, specify the Ordering No.

Name / Shape		Material/Dimensions	Part No.	Color Code *
	① Round flush	Polyarylate ø23.5 H4.2	HW1A-L1-*	R (red), G (green), Y (yellow), A (amber), C (clear), S (blue)
	② Square flush	Polyarylate ø24.6 H4	HW2A-L1-*	
	③ Round extended	Polyarylate ø23.3 H10	HW1A-L2-*	
	④ ø29 mushroom	AS, marking type ø29 H12.7	ALW31LD-*	
	⑤ ø40 mushroom	AS, marking type ø40 H12.7	ALW41LD-*	
	⑥ Dome for pilot light	AS ø23.5 H15.1	HW1A-P2-*	R (red), G (green), Y (yellow), A (amber), W (white), S (blue)
	① Round flush with round or square bezel	Polyacetal ø23.6 H3	HW1A-B1-*	<ul style="list-style-type: none"> • Use ① for Selector pushbuttons B (black), G (green), R (red), Y (yellow), S (blue), W (white)
	② Round extended with round or square bezel	Polyacetal ø23.6 H9.2	HW1A-B2-*	
	③ Square flush	Polyacetal □24.8 H3	HW2A-B1-*	
	④ Square extended	Polyacetal □24.5 H9.2	HW2A-B2-*	
	⑤ ø29 mushroom	Polyacetal ø29 H12.7 (M18P1.0)	HW1A-B3-*	
	⑥ ø40 mushroom	Polyacetal ø40 H12.7 (M18P1.0)	HW1A-B4-*	
Marking Plate	Round flush	Acrylic ø21.5 Thickness = 1	HW9Z-P11	<ul style="list-style-type: none"> • White • See page 63 for dimensions and engraving area.
	Round extended	Acrylic ø21.3 Thickness = 6.5	HW9Z-P12	
	Square flush	Acrylic 22.7 Thickness = 1	HW9Z-P21	
	ø29/40 mm mushroom	Acrylic ø15.7 H3.4	ALW3B	
Operator Knob for Illuminated Selector Switch	AS resin		HW9Z-FDY*	R (red), G (green), Y (yellow), A (amber), W (white), S (blue)
Operator Lever for Illuminated Selector Switch			HW9Z-FDL*	
Spare Key (Disc Tumber Key)	Metal (nickel-plated brass)		HW9Z-SKP	

Maintenance Parts

All dimensions in mm

When ordering, specify the Ordering No.

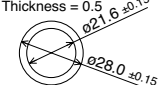
Name / Shape	Material/Dimensions	Part No.	Remarks
Spare Key (Pin Tumber Key) 	Metal (nickel-plated brass)	LW9Z-SK-500	• Standard key number
		LW9Z-SK-□	• Key number □ : 501 to 515
Lockig Ring 	Polyamide (black) ø28.4 H5 M22P1	HW9Z-LN	
Cap for Mono-lever Switch 	Standard Nitril rubber ø10 L20	HW9Z-CPM	
Boot for Mono-lever Switch 	Standard Nitril rubber ø29.2 L34.4	HW9Z-BLM	
Gasket 	Nitril rubber (black)	HW9Z-WM	Thickness = 0.5 

HW Series LED Lamps

When ordering, specify the Ordering No.

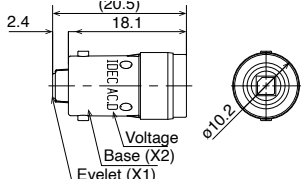
Shape/Dimensions	Operating Voltage	Current Draw		Part No.	Base
		DC	AC		
 	6V AC/DC	10mA	14mA	LSRD-6	BA9S/13
	12V AC/DC	7mA	8mA	LSRD-1	
	24V AC/DC	7mA	8mA	LSRD-2	
	100/120V AC/DC	2mA	2mA	LSRD-H2	
	200/220V AC	2mA	2mA	LSRD-M2	
	230/240V AC	2mA	2mA	LSRD-M4	

⚠ Safety Precautions

- Turn off the power to the HW series switches & pilot lights before starting installation, removal, wiring, maintenance, and inspection of the products. Failure to turn power off may cause electrical shocks or fire hazard.
- To avoid a burn on your hand, use the lamp holder tool when replacing lamps.

- For wiring, use wires of a proper size to meet the voltage, current requirements, and the number of connectable wires (page 65). Failure to tighten the terminal screws may cause overheating and fire.
- Avoid using in places mentioned below to maintain performance of the product.
 - Exposed to direct sunlight
 - Subject to corrosive or flammable gases

Instructions

Panel Mounting

1. Remove the contact block from the operator.
2. Remove the locking ring from the operator
3. Insert the operator into the panel cut-out from the front. When mounting the nameplate, insert between the operator and panel.
4. Tighten the locking ring from the back.

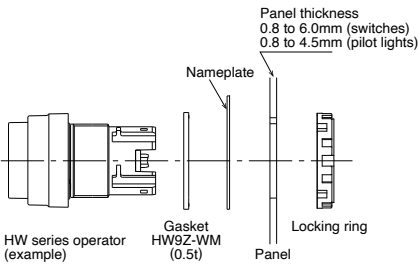

Mounting panel thickness is reduced by 1.5 mm when using a nameplate.

Removing the Contact Block

1. Remove the operator from the contact block by pushing and turning the locking lever in the direction of the arrow shown below. Then the operator can be pulled out.
2. To reinstall, place the TOP marking on the operator and the lock lever in the same direction, and insert the operator into the contact block mounting adapter. Then turn the locking lever in the opposite direction.

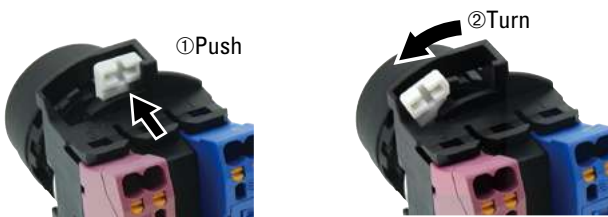

Anti-rotation Ring and Mounting Panel

Turn the TOP marking on the operator and the ▲ mark on the anti-rotation ring to the recess on the mounting panel.

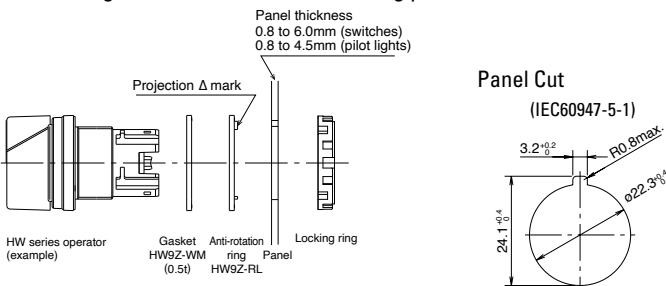

Installing the Pilot Light

Detach the operator unit from the LED unit. After mounting the operator from the front of the panel, attach the LED unit.

Installing / Removing the LED Unit

1. Detach the LED unit by lifting the latch using a small flat blade screwdriver width 0.5mm max.
2. To install, align the TOP marking on the operator with the TOP marking on the LED unit.

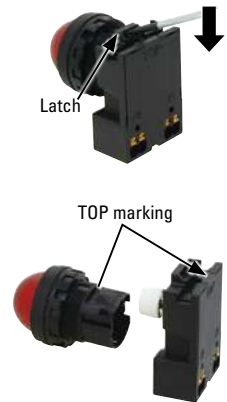

Notes for Panel Mounting

Locking ring wrench recommended torque
Tighten the bezel to a tightening torque of 2.0 N·m.

Locking ring wrench (MW9Z-T1) can be used to tighten the bezel. Do not use pliers. Excessive tightening will damage the locking ring.



Panel Thickness

HW series can be mounted on a panel with thickness of 0.8 to 6.0 mm (switches) and 0.8 to 4.5 mm (pilot lights). Take the thickness of nameplate and/or switch guard into consideration.

Instructions

Replacing LED Lamps

Lamps can be replaced using the lamp holder tool (OR-55) from the front of the panel, or by removing the contact block from the operator unit. (See page 53 for lamp holder tool.)

Removing the LED lamp from the front of the panel

Removing

To remove, slip the lamp holder tool onto the lamp head lightly. Then push slightly, and turn the lamp holder tool counterclockwise.

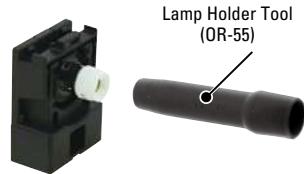

Installing

Insert the lamp head into the lamp holder tool.

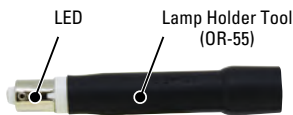

Place the pins on the lamp base to the grooves in the lamp socket. Insert the lamp and turn it clockwise.

Removing and Installing the Contact Blocks, Dummy Blocks, and LED Units

Removing

To remove the contact block and dummy block, insert into the flat blade screwdriver latch and move in the direction of the arrow.

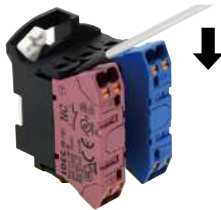

Installing

When installing the contact block or dummy block, make sure that it snaps on to the operator.

For No. 1 and 3 only a contact block or dummy block can be installed.

For No. 2, only a dummy block can be installed.

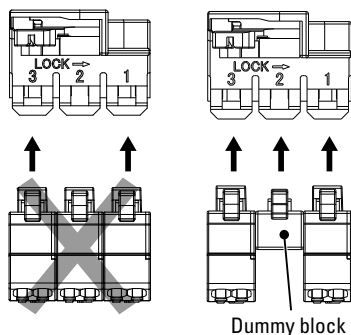

Note) Make sure to attach a correctly assembled connection unit to the operator.

Note) When attaching the contact block to the connection unit, make sure that the connection is detached from the operator. If a contact block is installed with the operator attached to the connection unit, malfunction of the switch may occur.

Note) Full voltage adapters cannot be removed or attached with contact blocks attached.

Note) Attach the full voltage adapter vertically to the connection unit.

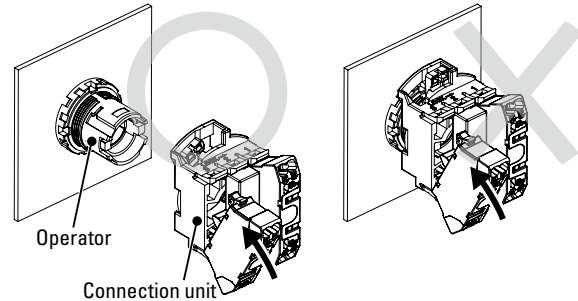

Test Points

Note) Do not insert wires into the test point.

Single contact block

Note) When conducting a continuity test on the contact block, make sure that probes (ø2.0 maximum) of the tester are inserted vertically to the panel.

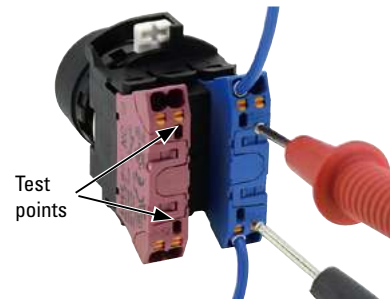

Double contact block

When conducting a continuity test on the first deck, make sure that probes (ø2.0 maximum) of the tester are inserted in an angle of the contact block, in two places as shown below.

When conducting a continuity test on the second deck, make sure that probes (ø2.0 maximum) of the tester are inserted vertically to the panel.

① First deck

Test point location

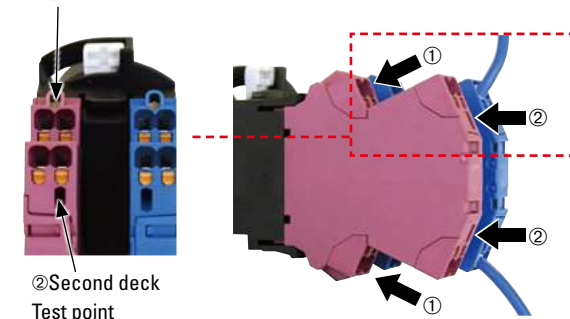

② Second deck
Test point

Instructions

Installing/Removing the Buttons and Lenses

<To install>

<To remove>

Pushbutton Button

• Flush/Extended

Push in the button to install.



Insert a flat screwdriver between the button and the bezel to remove the button.

• Mushroom/Jumbo Mushroom

Button has threads. Turn clockwise to install the button.



Turn the button counterclockwise to remove.
Note: Jumbo mushroom button cannot be removed.



Illuminated Pushbutton Lens

• Flush/Extended

Push in the lens holder into the operator unit.

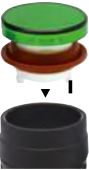

Insert a flat screwdriver between the button and the bezel to remove the lens holder.



• Mushroom/Jumbo Mushroom

Lens has threads. Turn clockwise to install the lens.



Lens has threads. Turn counterclockwise to remove the lens.



Pilot Light Lens

• Extended

Lens has threads. Turn clockwise to install the lens.



Turn the lens counterclockwise to remove.



• Square Flush

Push in the lens holder into the operator unit.



Insert a flat screwdriver between the lens and the bezel to remove.



Installing/Removing the Lenses and Marking Plates

Removing

Removing the lens unit

Insert a flat screwdriver in groove of the lens (TOP mark side of the operator or opposite side) to remove the lens unit (lens/marketing plate/ lens holder).



Removing the lens

Remove the lens by pushing the lens from the rear to disengage the latches between the lens and the lens holder, using a flat screwdriver as shown below.

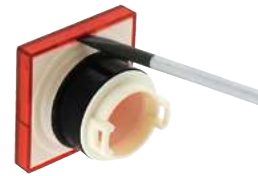

Note: The translucent filter in the lens holder cannot be removed because this filter is sealed to make the unit waterproof and oiltight.

Installing

1. Place the marking plate on the lens holder with the anti-rotation projection engaged and press the lens onto the lens holder to engage the latches.
2. Place the marking plate in the correct orientation.

For Square Lens (square flush lens)
*Note the orientation of the parts.



Lens Marking plate Lens holder

Instructions

Using a Ring Adapter

HW9Z-A25

Install the ring adapter between the HW series unit and panel. Make sure that the side with ridges face the panel.



Nitril Rubber

Dimensions

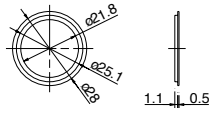

Installation

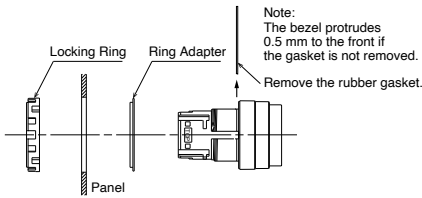

Panel Cut-out

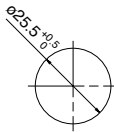

HW9Z-A30

The ring adapter HW9Z-A30 consists of a washer and adapter. Install adapter between the HW series unit and panel. Install washer between the locking ring and panel.



Washer: metal (brass)



Adapter: polyamide

Dimensions

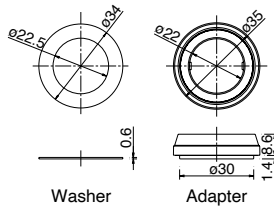

Panel Cut-out

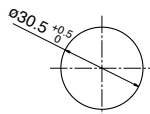

Installation

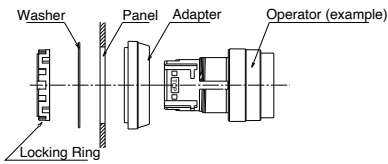

Dual Pushbutton Switches

The pushbuttons cannot be removed or replaced. Do not attempt to remove using a flat screwdriver or pliers, otherwise the pushbuttons may be damaged.

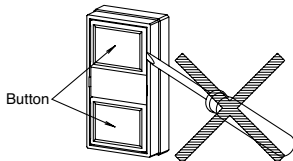

Installing the Rubber Boot for Dual Pushbuttons

When using the HW7D pushbuttons in places where the pushbuttons are subject to water splash or an excessive amount of dust, make sure to use the HW9Z-D7D rubber boot (IP65) which is ordered separately. Remove the rubber gasket pre-installed on the operator, and install the rubber boot from the front of the button.

Notes for Installing the Rubber Boot

Remove the gasket from the operator, and install the rubber boot on the operator. Pull out the seals of the rubber boot and place them around the operator sleeve as shown. Make sure that the seals are not twisted or tucked inside and that the gasket does not remain, otherwise the normal waterproof and dustproof characteristics are not ensured.

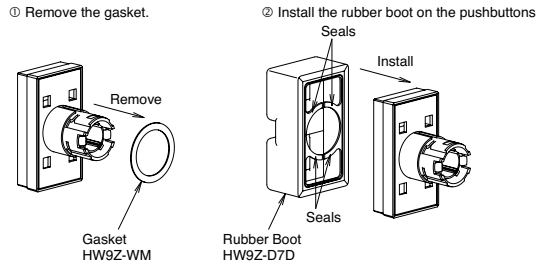

Rubber Boot Installed

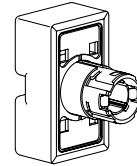

Selector Switches

Turn the operator such as knob, lever, and key to each position accurately. Releasing halfway may cause the operator to return to the former position, or to get stuck between. On spring return two-way types, the center of operators may be misaligned slightly.

Key Selector Switches

Observe the following instructions to prevent malfunction or damage.

- Turn the key securely to each position.
- Insert the key to the bottom of the key hole.
- Do not remove the key from any key retained position.
- Use a key that matches with the number on the key cylinder. However, for standard keys, the key number is engraved on the key but not on the key cylinder.

Instructions

Marking

For HW series pilot lights, legends and symbols can be engraved on the built-in marking plates, or printed film can be inserted under the lens for labeling purposes.

Marking plate and marking film size (mm)

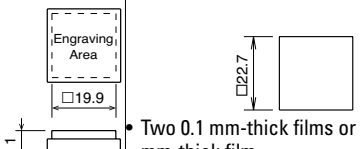
Built-in marking plate and engraving area	Applicable marking film size
Outside diameter: □22.7 Engraving depth: 0.5mm max.	 • Two 0.1 mm-thick films or one 0.2 mm-thick film

*Marking films are not supplied.

Insertion Order of Marking Plate and Film

Square Lens (Square flush lens)

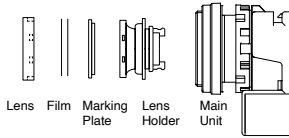

Note: Films are not supplied. When inserting a film, make sure that the marking plate is installed with its uneven side facing the lens holder.

Nameplate

Mounting panel thickness is reduced by 1.5 mm when using a nameplate.

Installing a Marking Plate

Insert a marking plate in the direction of the arrow ①, and press in as shown ②.

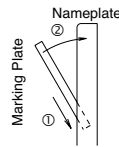

Removing a Marking Plate

Insert a flat screwdriver into the upper middle part of the marking plate and remove. When anti-rotation is not required, remove the projection from the nameplate using pliers.

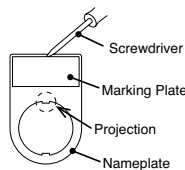

Applicable Wire

When wiring, use the applicable wires shown below.

Applicable Wire and Specifications

Applicable Wire (*1)	0.25 to 1.5mm ² (AWG16 to 24)
Wire Strip Length (*2)	8 ± 1mm (*3)
Ferrule Size (*3) (Weidmüller)	H0.25 to H1.5 (without insulated cover) H0.25 to H1.5 (with insulated cover)

- *1) For applicable wires confirmed by IDEC, see website.
- *2) For details on ferrules, see "Wire Size and Recommended Ferrules" table below.
- *3) Strip the sheath of the wire 8±1mm from the end.

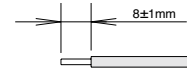

Note: Make sure that the stranded wires do not loosen when using wiring without ferrules.

Wire Size and Recommended Ferrules

Ferrules without insulated covers

Applicable Wire (Stranded Wire)		Wire Strip Length	Weidmüller Recommended Part No.
AWG	mm ²		
24	0.25	5 to 6mm	H0.25/5
20	0.50	10 to 11mm	H0.5/10
18	0.75	10 to 11mm	H0.75/10
18	1.00	10 to 11mm	H1.0/10
16	1.50	10 to 11mm	H1.5/10

Ferrules with insulated covers

Applicable Wire (Stranded Wire)		Wire Strip Length	Weidmüller Recommended Part No.
AWG	mm ²		
24	0.25	10 to 11mm	H0.25/12 HBL
22	0.34	10 to 11mm	H0.34/12 TK
20	0.50	10 to 11mm	H0.5/14 OR
18	0.75	10 to 11mm	H0.75/14 W
18	1.00	10 to 11mm	H1.0/14 GE
16	1.50	10 to 11mm	H1.5/14 R

Recommended Tools (Optional)

Name	Weidmüller Recommended Part No.
Crimping tool	PZ 6 ROTO L
Flat blade screwdriver	SDS 0.4×2.0×60
	SDS 0.4×2.5×75

- Note 1) Note the crimping dimensions When using tools other than the recommended crimping tool. For details, see page 65.
- Note 2) Use a flat blade screwdriver with a blade size of 0.4×2 to 2.5 mm.

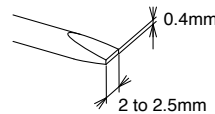

• For details on crimping tools, see page 55.

Instructions

Wiring Procedure

Connecting the wire

Stranded wires with ferrules or solid wire

- ① Insert the wire to the back of the wire port.
- ② After wiring, tug lightly to make sure that the wire is properly connected.

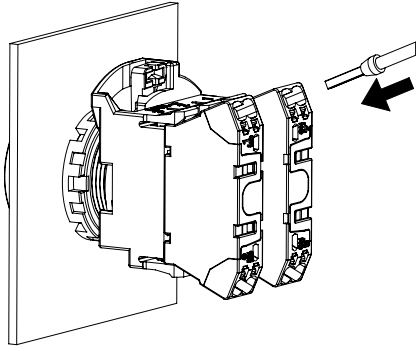

Stranded wire

- ① While pressing the pusher (orange button) using a flat blade screwdriver (recommended: SDS 0.4×2.0×60 (optional)). Insert the wire fully in the wiring port. Wire is connected when the pusher is released.
- ② After wiring, tug lightly to make sure that the wire is properly connected.

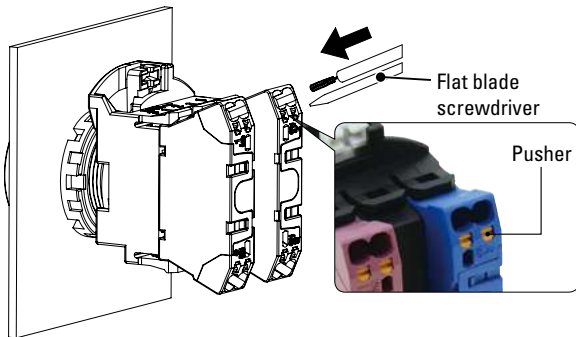

Crimping of Ferrules and Wiring

- Choose an appropriate ferrule for the wire.
- Cut the wire carefully to get a flat end.
- Make sure that ferrule sleeve is completely filled by the conductor. Depending on the cross section, the conductor should protrude approx. 0 to 1 mm from the ferrule sleeve.

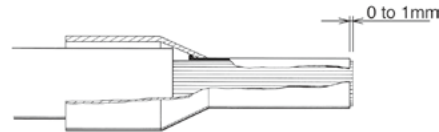

- When crimping, refer to the instructions of the crimping tool.

Faults which can occur during crimping:

- Cracks along the sides and die impressions
- Splitting of the ferrules
- Asymmetrical crimping shape
- Extreme burrs formed along the sides
- Ferrule not filled by conductor
- Single conductors pushed back by protruding from the insulated cover
- Single conductors squeezed off
- Insulation cover damaged by the crimping jaw
- Conductor insulation not pushed into the insulated cover
- Ferrule bent longitudinally after crimping

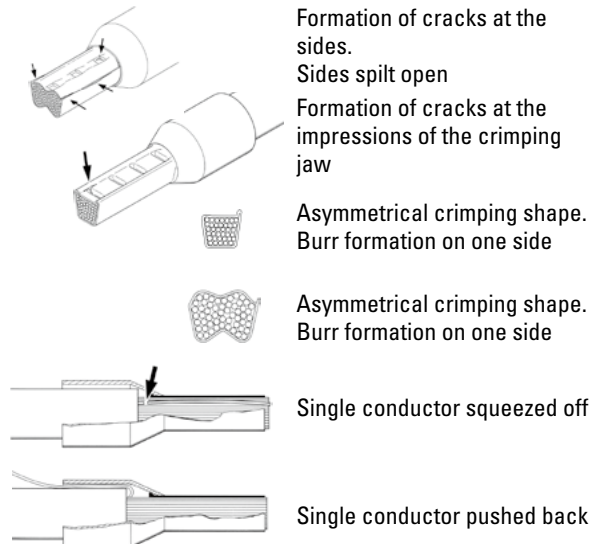

Instructions

Crimping dimensions: W2.4×H1.9 mm

Maximum connectable crimping size is W2.4×H1.9. Make sure that the ferrule size will be smaller than this dimension. (Recommended crimping tool: PZ 6 Roto (optional) Weidmüller)

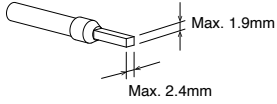

Note 1) If a tool other than the recommended crimping tool is used, the ferrule may not be crimped to the appropriate size and the clamp or spring inside the contact block may be deformed and may not operate normally.

Note 2) Pin crimp terminals cannot be used.

Removing the Wire

When removing the wire, push the pusher using a flat blade screwdriver (recommended: SDS 0.4×2.0×60 (optional: see page 55)) and pull wire out in the direction of the arrow.

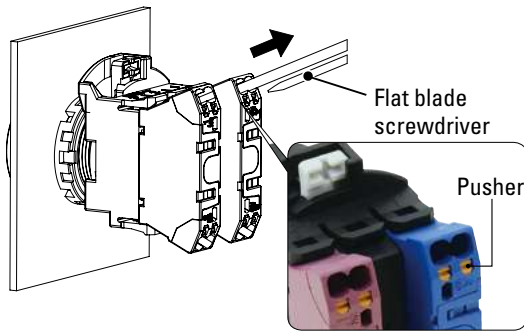

<Notes>

- Operate the pusher with a force of 20N. Do not press excessively. Otherwise, the switch may be damaged.
- Do not pull the wire out without depressing the pusher. When pulling the wire, be sure to pull in a straight direction. Otherwise, the socket may be damaged.

Number of Connectable Wires

Unit	Connectable wires		No. of connectable wires
HW-P Contact block	Solid wire	0.25 to 1.5mm ² (AWG16 to 24)	2
	Stranded wire	0.25 to 1.5mm ² (AWG16 to 24)	
Pilot light	Ferrule	Without insulated cover 0.25mm ² : conductor length:5 to 10mm 0.5 to 1.0mm ² : conductor length: 6 to 10mm 1.5mm ² : conductor length 8 to 10mm With insulated cover 0.25 to 1.0mm ² : conductor length 6 to 10mm 1.5mm ² : conductor length 8 to 10mm Note) Pin terminals cannot be used	

Note) Only one wire can be inserted into one wire port.

Instructions (Emergency Stop Switches)

When using the HW series control units in a safety-related circuit of a control system, observe safety rules and regulations of each country concerning particular applications of the actual machines and facilities. Perform risk assessment before operation to ensure safety.

Chattering / Contact Bounce

When the button is reset by pulling or turning, the NC main contacts will bounce. When pressing the button, the NO monitor contacts will bounce. When designing a control circuit, take the contact bounce time into consideration (reference value: 20 ms).

Also, do not apply shock to the switch as chattering may occur.

Nameplate or Switch Guard

When anti-rotation is not required, remove the projection from the nameplate or switch guard using pliers. Mechanical indicator types have projections on the operator. Make sure to remove the projection on the nameplate or switch guard.

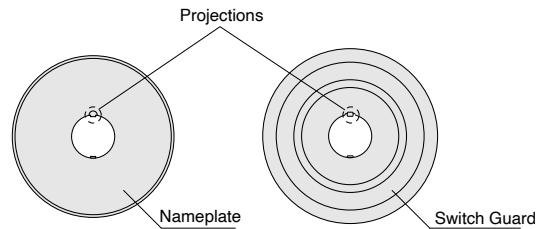

Handling

Do not expose the switch to excessive shocks and vibrations, otherwise the switch may be deformed or damaged, causing malfunction or operation failure.

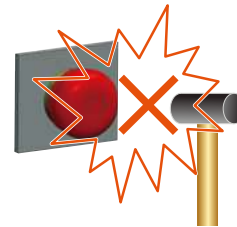

Instructions (Illuminated / Non-illuminated Buzzers)

Installing the terminal rubber boot

1. Cut the end of terminal rubber boot to fit the cable size.
2. Insert the cable into the terminal rubber boot in the direction of arrow shown below.

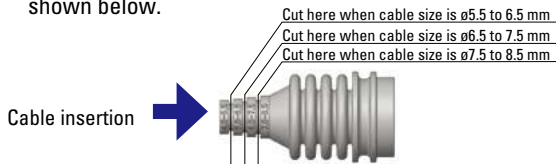

3. Strip the insulation of the cable 30 mm from the end and wire as instructed in "Wiring".
4. Install the terminal rubber boot as shown below.

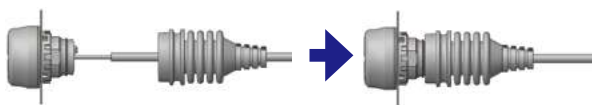

5. Cover part B with part A.



6. Make sure that the bellows is 17 to 22 mm long.

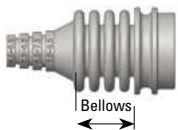

Note for terminal rubber boot

- Be sure to use bellows with an appropriate length. Otherwise, waterproof characteristics cannot be achieved.
- Maintain a cable angle of 45° maximum to the axis of the buzzer, otherwise the terminal rubber boot may come off.

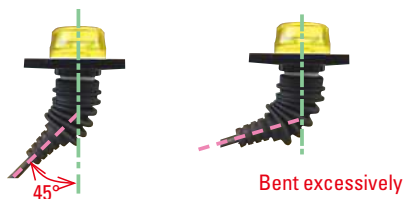

Panel Mounting

- Insert the buzzer into the panel cut-out from the front, and tighten the locking ring from the back.

Note for panel mounting

- Use the optional locking ring wrench (MW9Z-T1) to tighten the locking ring to a recommended tightening torque of 1.5 to 2.0 N·m.
- Do not use pliers and do not tighten excessively, otherwise the buzzer may be damaged.

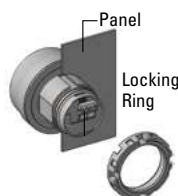

Wiring Procedure

Connecting the wire

Solid wire

Strip the insulation of the cable from 8mm from the end and insert into the wire port.

After wiring, tug lightly to make sure that the wire is properly connected.

Stranded wire with ferrule

Crimp a ferrule with a conductor length of 8mm and insert to the back of the wire port. After wiring, tug lightly to make sure that the wire is properly connected.

Stranded wire

Strip the wire insulation 8mm from the end and push in the wire release pin above the wire port using a small flat screwdriver. Release the wire release pin. Make sure that the wire does not loosen.

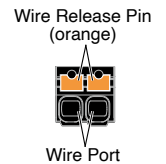

Wire removal

Push in the orange color wire release pin above the wire ports using a small flat screw driver, and pull out the wire.

Flat blade screwdriver

Use a flat blade screwdriver blade size 2.5mm

Notes for wiring

- Make sure that the terminal is not constantly pulled by the wire.
- Wiring must be performed in environments of -5 to +50°C.
- Do not damage the conductor wire when stripping the wire insulation.
- Do not use wires with bent or deformed conductor wires. Deformed wiring may cause failures such as strength degradation and overheating. Connecting one wire per terminal. Connecting two wires to a terminal may cause loose wiring and strength degradation.
- Do not solder the conductor lines. Connecting soldered stranded wires may cause loose wiring and strength degradation.
- If a stranded wire has loose wires, twist the conductor wires before connection. However be careful not to twist excessively.

OUR CERTIFICATE

DiGi provide top-quality products and perfect service for customer worldwide through standardization, technological innovation and continuous improvement. DiGi through third-party certification, we stricly control the quality of products and services. Welcome your RFQ to

Email: Info@DiGi-Electronics.com



Tel: +00 852-30501935

RFQ Email: Info@DiGi-Electronics.com

DiGi is a global authorized distributor of electronic components.