

AOT2606L Datasheet

www.digi-electronics.com

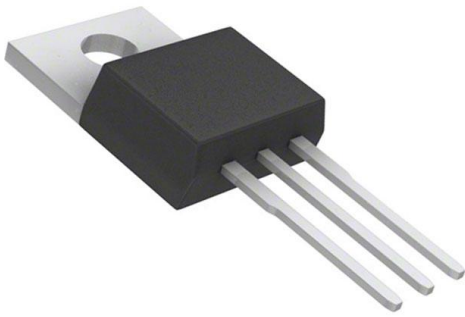

<https://www.DiGi-Electronics.com>

DiGi Electronics Part Number	AOT2606L-DG
Manufacturer	Alpha & Omega Semiconductor Inc.
Manufacturer Product Number	AOT2606L
Description	MOSFET N-CH 60V 13A/72A TO220
Detailed Description	N-Channel 60 V 13A (Ta), 72A (Tc) 2.1W (Ta), 115W (Tc) Through Hole TO-220



Tel: +00 852-30501935

RFQ Email: Info@DiGi-Electronics.com

DiGi is a global authorized distributor of electronic components.

Purchase and inquiry

Manufacturer Product Number:

AOT2606L

Series:

-

FET Type:

N-Channel

Drain to Source Voltage (Vdss):

60 V

Drive Voltage (Max Rds On, Min Rds On):

10V

Vgs(th) (Max) @ Id:

3.5V @ 250µA

Vgs (Max):

±20V

FET Feature:

-

Operating Temperature:

-55°C ~ 175°C (Tj)

Supplier Device Package:

TO-220

Base Product Number:

AOT2606

Manufacturer:

Alpha & Omega Semiconductor Inc.

Product Status:

Active

Technology:

MOSFET (Metal Oxide)

Current - Continuous Drain (Id) @ 25°C:

13A (Ta), 72A (Tc)

Rds On (Max) @ Id, Vgs:

6.5mOhm @ 20A, 10V

Gate Charge (Qg) (Max) @ Vgs:

75 nC @ 10 V

Input Capacitance (Ciss) (Max) @ Vds:

4050 pF @ 30 V

Power Dissipation (Max):

2.1W (Ta), 115W (Tc)

Mounting Type:

Through Hole

Package / Case:

TO-220-3

Environmental & Export classification

RoHS Status:

ROHS3 Compliant

REACH Status:

REACH Unaffected

HTSUS:

8541.29.0095

Moisture Sensitivity Level (MSL):

1 (Unlimited)

ECCN:

EAR99



AOT2606L/AOB2606L/AOTF2606L
60V N-Channel MOSFET

<p>General Description</p> <p>The AOT2606L & AOB2606L & AOTF2606L uses Trench MOSFET technology that is uniquely optimized to provide the most efficient high frequency switching performance. Both conduction and switching power losses are minimized due to an extremely low combination of $R_{DS(ON)}$, C_{iss} and C_{oss}. This device is ideal for boost converters and synchronous rectifiers for consumer, telecom, industrial power supplies and LED backlighting.</p>	<p>Product Summary</p> <table border="0"> <tr> <td>V_{DS}</td> <td>60V</td> </tr> <tr> <td>I_D (at $V_{GS}=10V$)</td> <td>72A</td> </tr> <tr> <td>$R_{DS(ON)}$ (at $V_{GS}=10V$)</td> <td>< 6.5mΩ (< 6.2mΩ^*)</td> </tr> </table> <p>100% UIS Tested 100% R_g Tested</p> 	V_{DS}	60V	I_D (at $V_{GS}=10V$)	72A	$R_{DS(ON)}$ (at $V_{GS}=10V$)	< 6.5m Ω (< 6.2m Ω^*)
V_{DS}	60V						
I_D (at $V_{GS}=10V$)	72A						
$R_{DS(ON)}$ (at $V_{GS}=10V$)	< 6.5m Ω (< 6.2m Ω^*)						

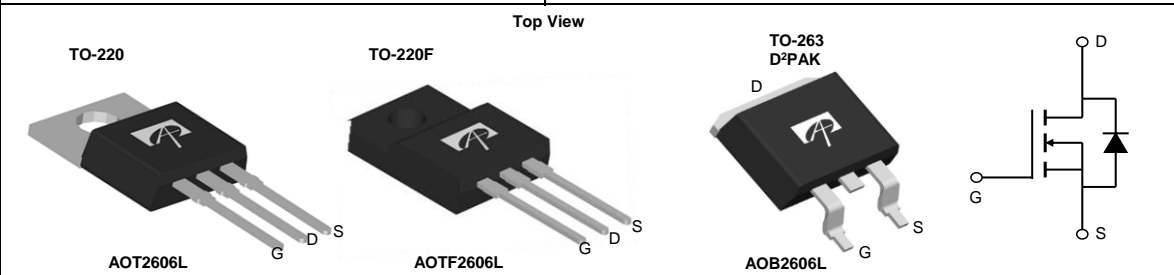

Absolute Maximum Ratings $T_A=25^\circ C$ unless otherwise noted

Parameter	Symbol	AOT2606L/AOB2606L	AOTF2606L	Units
Drain-Source Voltage	V_{DS}	60		V
Gate-Source Voltage	V_{GS}	± 20		V
Continuous Drain Current ^G	I_D	$T_C=25^\circ C$	72	54
		$T_C=100^\circ C$	56	38
Pulsed Drain Current ^C	I_{DM}	260		A
Continuous Drain Current	I_{DSM}	$T_A=25^\circ C$	13	
		$T_A=70^\circ C$	10	
Avalanche Current ^C	I_{AS}	60		A
Avalanche energy $L=0.1mH$ ^C	E_{AS}	180		mJ
Power Dissipation ^B	P_D	$T_C=25^\circ C$	115	36.5
		$T_C=100^\circ C$	57.5	18
Power Dissipation ^A	P_{DSM}	$T_A=25^\circ C$	2.1	
		$T_A=70^\circ C$	1.3	
Junction and Storage Temperature Range	T_J, T_{STG}	-55 to 175		$^\circ C$

Thermal Characteristics

Parameter	Symbol	AOT2606L/AOB2606L	AOTF2606L	Units
Maximum Junction-to-Ambient ^A	$R_{\theta JA}$	15	15	$^\circ C/W$
Maximum Junction-to-Ambient ^{A D}		60	60	$^\circ C/W$
Maximum Junction-to-Case	$R_{\theta JC}$	1.3	4.1	$^\circ C/W$

* Surface mount package TO263

Electrical Characteristics (T_J=25°C unless otherwise noted)

Symbol	Parameter	Conditions	Min	Typ	Max	Units
STATIC PARAMETERS						
BV _{DSS}	Drain-Source Breakdown Voltage	I _D =250μA, V _{GS} =0V	60			V
I _{DSS}	Zero Gate Voltage Drain Current	V _{DS} =60V, V _{GS} =0V T _J =55°C			1 5	μA
I _{GSS}	Gate-Body leakage current	V _{DS} =0V, V _{GS} =±20V			±100	nA
V _{GS(th)}	Gate Threshold Voltage	V _{DS} =V _{GS} , I _D =250μA	2.5	3	3.5	V
I _{D(ON)}	On state drain current	V _{GS} =10V, V _{DS} =5V	260			A
R _{DS(ON)}	Static Drain-Source On-Resistance	V _{GS} =10V, I _D =20A TO220/TO220F T _J =125°C		5.4 8.5	6.5 10.5	mΩ
		V _{GS} =10V, I _D =20A TO263		5.1	6.2	mΩ
g _{FS}	Forward Transconductance	V _{DS} =5V, I _D =20A		75		S
V _{SD}	Diode Forward Voltage	I _S =1A, V _{GS} =0V		0.7	1	V
I _S	Maximum Body-Diode Continuous Current ^G				72	A
DYNAMIC PARAMETERS						
C _{iss}	Input Capacitance	V _{GS} =0V, V _{DS} =30V, f=1MHz		4050		pF
C _{oss}	Output Capacitance			345		pF
C _{riss}	Reverse Transfer Capacitance			16.8		pF
R _g	Gate resistance	V _{GS} =0V, V _{DS} =0V, f=1MHz	0.3	0.65	1.0	Ω
SWITCHING PARAMETERS						
Q _g (10V)	Total Gate Charge	V _{GS} =10V, V _{DS} =30V, I _D =20A		53	75	nC
Q _g (4.5V)	Total Gate Charge			22	31	nC
Q _{gs}	Gate Source Charge			17		nC
Q _{gd}	Gate Drain Charge			5		nC
t _{D(on)}	Turn-On DelayTime	V _{GS} =10V, V _{DS} =30V, R _L =1.5Ω, R _{GEN} =3Ω		18		ns
t _r	Turn-On Rise Time			20		ns
t _{D(off)}	Turn-Off DelayTime			33		ns
t _f	Turn-Off Fall Time			4		ns
t _{rr}	Body Diode Reverse Recovery Time	I _F =20A, di/dt=500A/μs		26		ns
Q _{rr}	Body Diode Reverse Recovery Charge	I _F =20A, di/dt=500A/μs		125		nC

A. The value of R_{θJA} is measured with the device mounted on 1in² FR-4 board with 2oz. Copper, in a still air environment with T_A=25° C. The Power dissipation P_{DSM} is based on R_{θJA} and the maximum allowed junction temperature of 150° C. The value in any given application depends on the user's specific board design, and the maximum temperature of 175° C may be used if the PCB allows it.

B. The power dissipation P_D is based on T_{J(MAX)}=175° C, using junction-to-case thermal resistance, and is more useful in setting the upper dissipation limit for cases where additional heatsinking is used.

C. Repetitive rating, pulse width limited by junction temperature T_{J(MAX)}=175° C. Ratings are based on low frequency and duty cycles to keep initial T_J=25° C.

D. The R_{θJA} is the sum of the thermal impedance from junction to case R_{θJC} and case to ambient.

E. The static characteristics in Figures 1 to 6 are obtained using <300μs pulses, duty cycle 0.5% max.

F. These curves are based on the junction-to-case thermal impedance which is measured with the device mounted to a large heatsink, assuming a maximum junction temperature of T_{J(MAX)}=175° C. The SOA curve provides a single pulse rating.

G. The maximum current limited by package.

H. These tests are performed with the device mounted on 1 in² FR-4 board with 2oz. Copper, in a still air environment with T_A=25° C.

APPLICATIONS OR USES AS CRITICAL COMPONENTS IN LIFE SUPPORT DEVICES OR SYSTEMS ARE NOT AUTHORIZED. AOS DOES NOT ASSUME ANY LIABILITY ARISING OUT OF SUCH APPLICATIONS OR USES OF ITS PRODUCTS. AOS RESERVES THE RIGHT TO MAKE CHANGES TO PRODUCT SPECIFICATIONS WITHOUT NOTICE. IT IS THE RESPONSIBILITY OF THE CUSTOMER TO EVALUATE SUITABILITY OF THE PRODUCT FOR THEIR INTENDED APPLICATION. CUSTOMER SHALL COMPLY WITH APPLICABLE LEGAL REQUIREMENTS, INCLUDING ALL APPLICABLE EXPORT CONTROL RULES, REGULATIONS AND LIMITATIONS.

AOS' products are provided subject to AOS' terms and conditions of sale which are set forth at:

http://www.aosmd.com/terms_and_conditions_of_sale

TYPICAL ELECTRICAL AND THERMAL CHARACTERISTICS

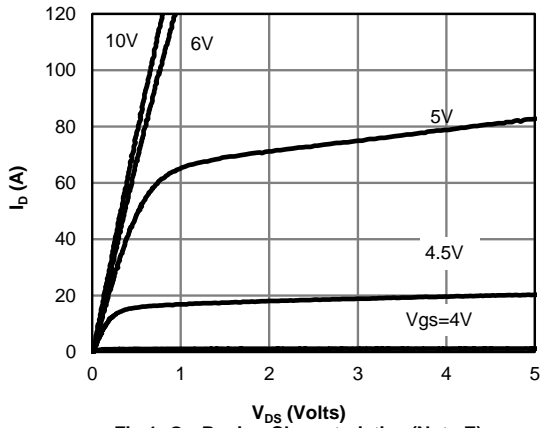

Figure 1: On-Region Characteristics (Note E)

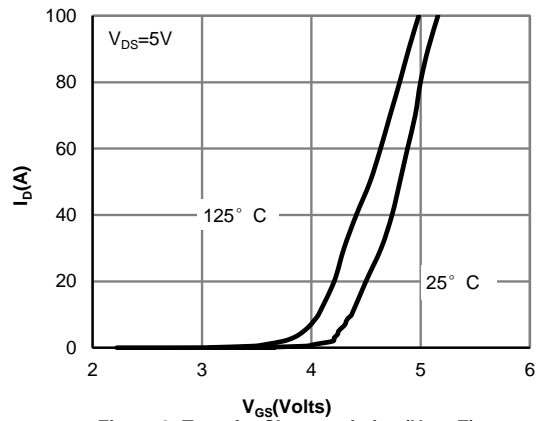

Figure 2: Transfer Characteristics (Note E)

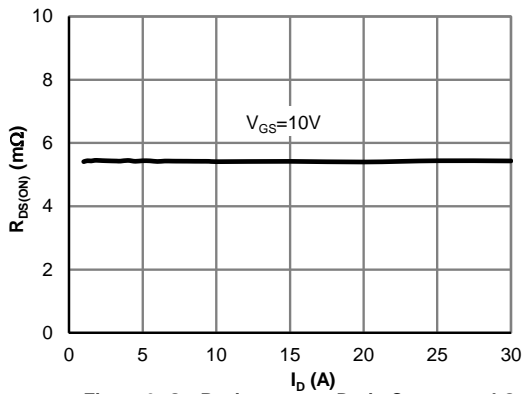

Figure 3: On-Resistance vs. Drain Current and Gate Voltage (Note E)

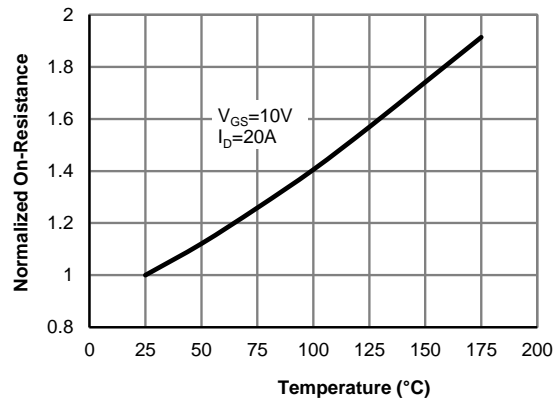

Figure 4: On-Resistance vs. Junction Temperature (Note E)

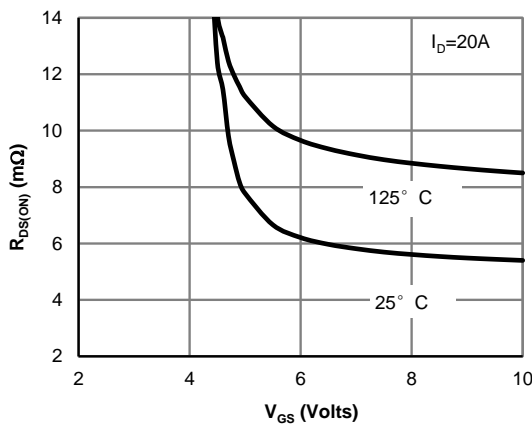

Figure 5: On-Resistance vs. Gate-Source Voltage (Note E)

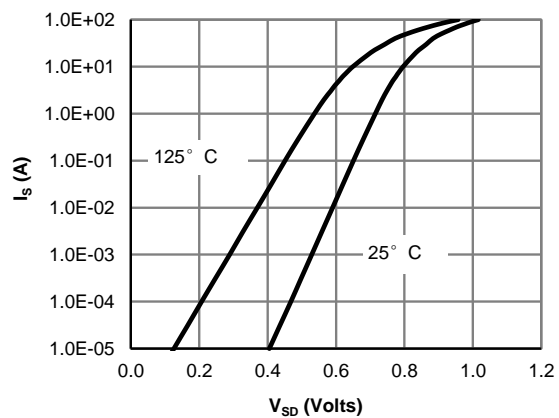

Figure 6: Body-Diode Characteristics (Note E)

TYPICAL ELECTRICAL AND THERMAL CHARACTERISTICS

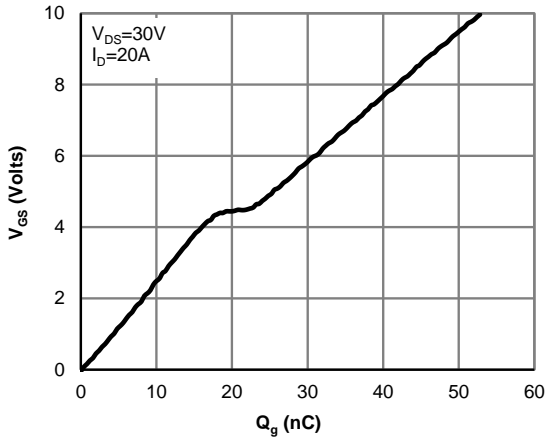

Figure 7: Gate-Charge Characteristics

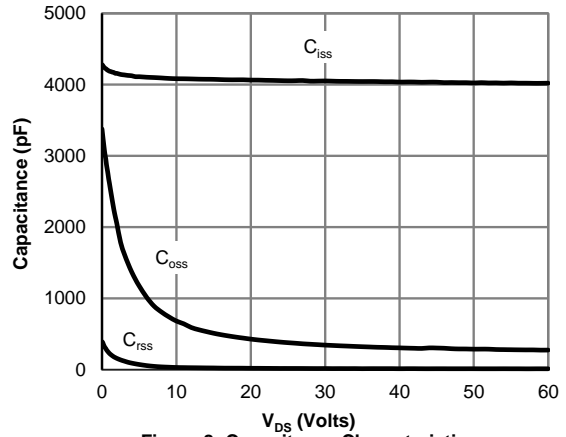

Figure 8: Capacitance Characteristics

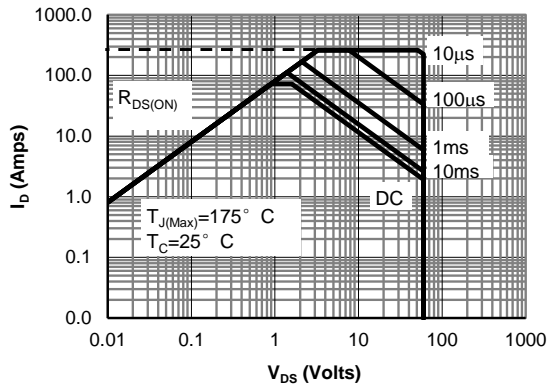

Figure 9: Maximum Forward Biased Safe Operating Area for AOT2606L and AOB2606L (Note F)

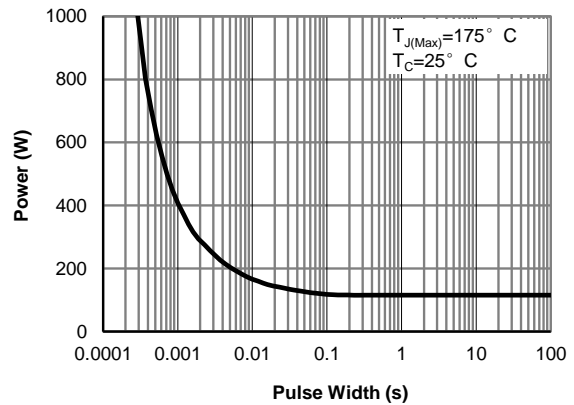

Figure 10: Single Pulse Power Rating Junction-to-Case for AOT2606L and AOB2606L (Note F)

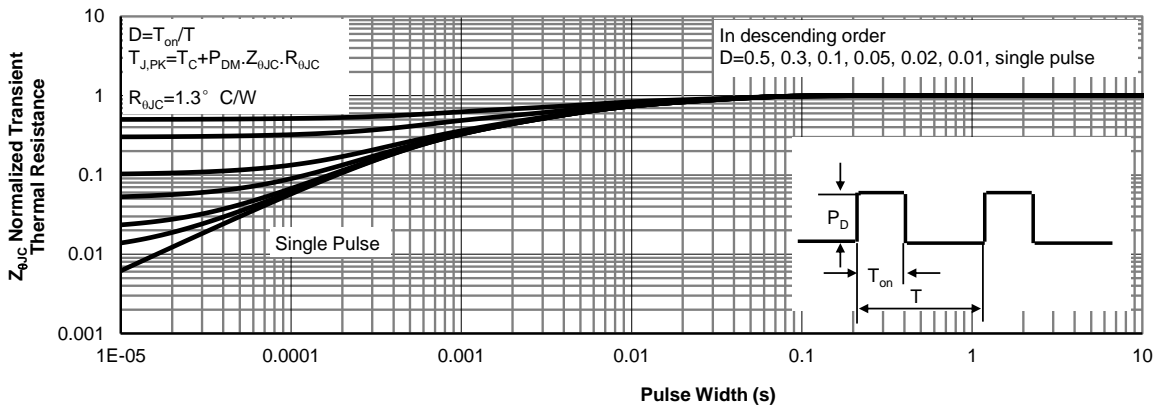

Figure 11: Normalized Maximum Transient Thermal Impedance for AOT2606L and AOB2606L (Note F)

TYPICAL ELECTRICAL AND THERMAL CHARACTERISTICS

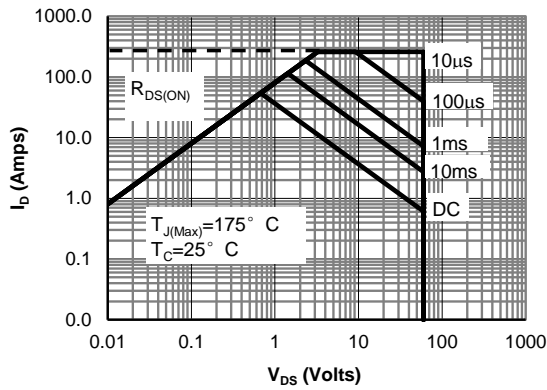

Figure 9: Maximum Forward Biased Safe Operating Area for AOTF2606L

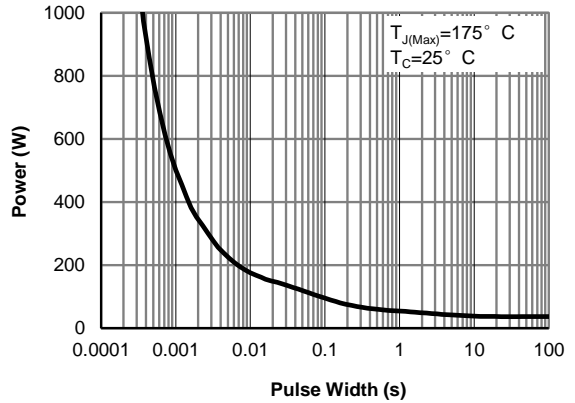

Figure 10: Single Pulse Power Rating Junction-to-Case for AOTF2606L (Note F)

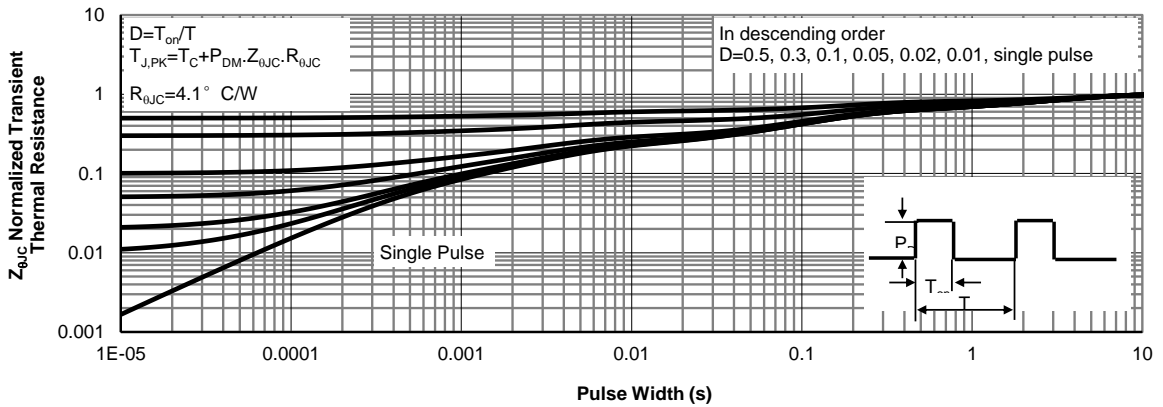

Figure 11: Normalized Maximum Transient Thermal Impedance for AOTF2606L (Note F)

TYPICAL ELECTRICAL AND THERMAL CHARACTERISTICS

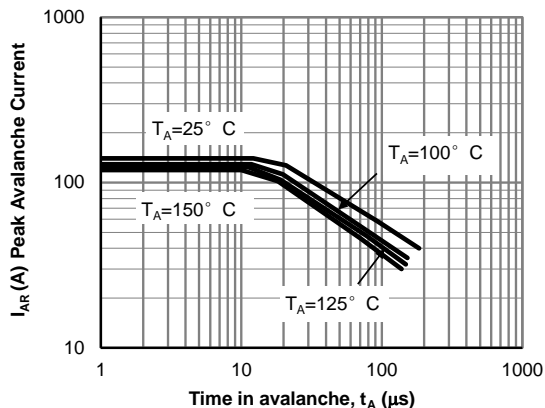

Figure 12: Single Pulse Avalanche capability (Note C)

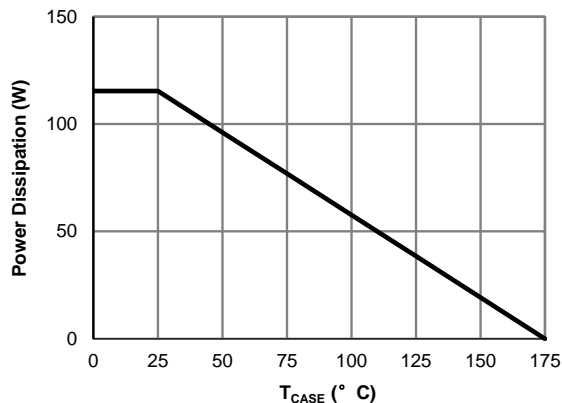

Figure 13: Power De-rating for AOT2606L and AOB2606L (Note F)

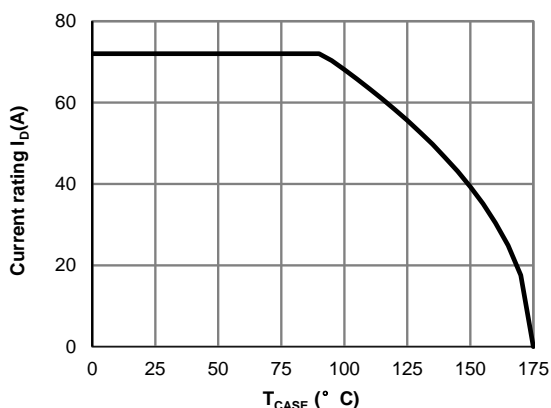

Figure 14: Current De-rating for AOT2606L and AOB2606L (Note F)

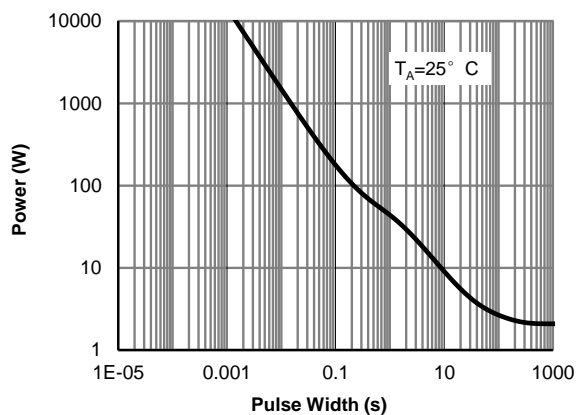

Figure 15: Single Pulse Power Rating Junction-to-Ambient (Note H)

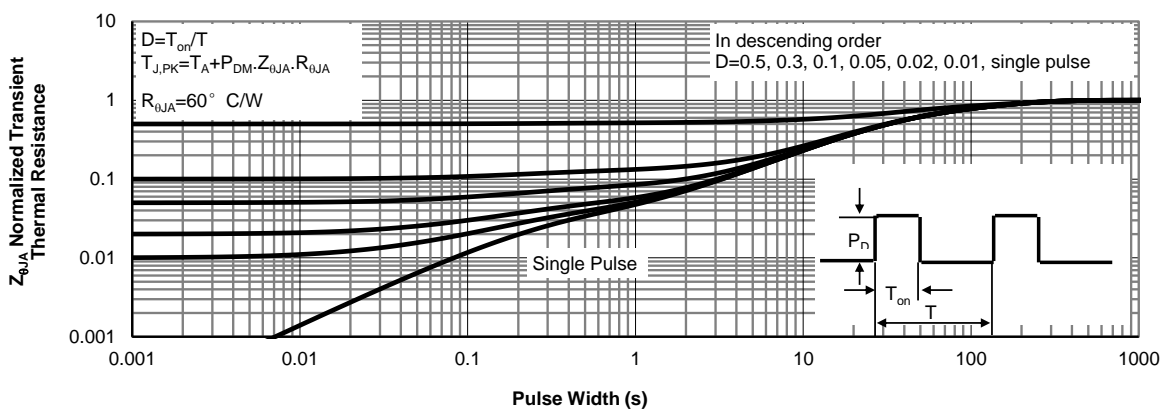
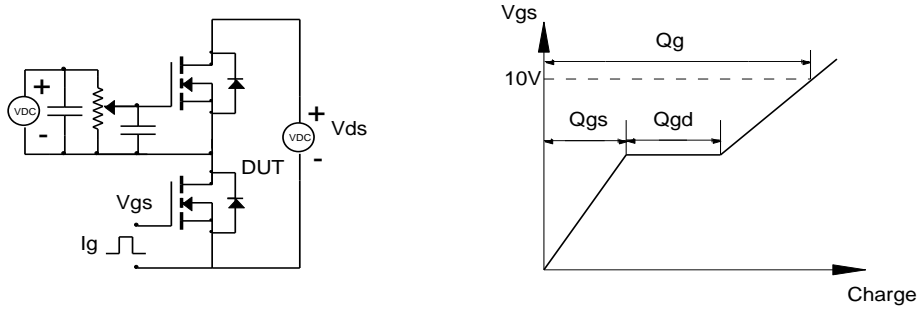
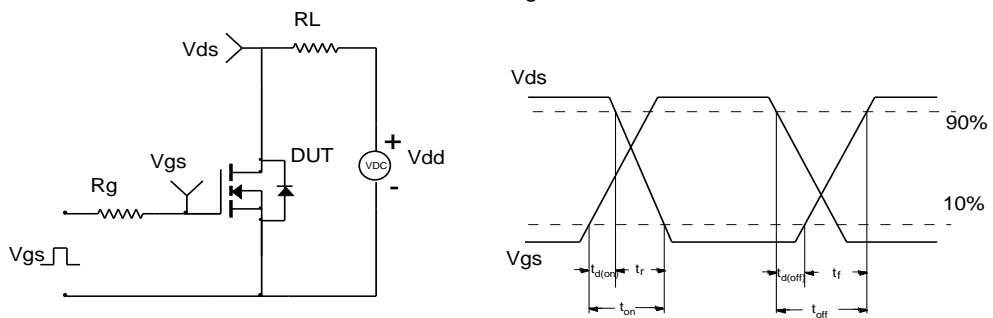

Figure 16: Normalized Maximum Transient Thermal Impedance (Note H)

Gate Charge Test Circuit & Waveform



Resistive Switching Test Circuit & Waveforms



Unclamped Inductive Switching (UIS) Test Circuit & Waveforms

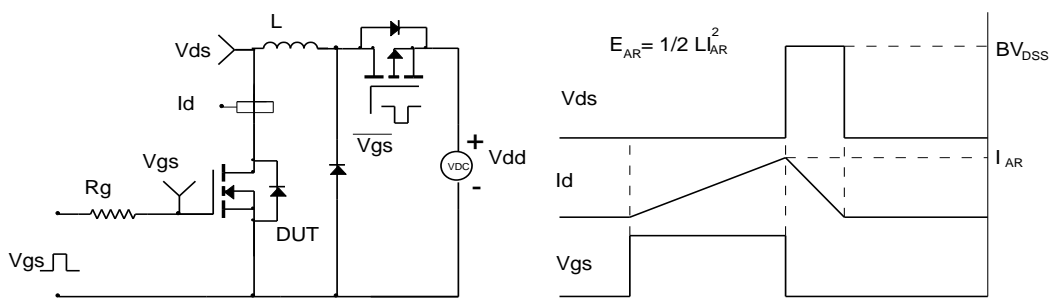

Diode Recovery Test Circuit & Waveforms

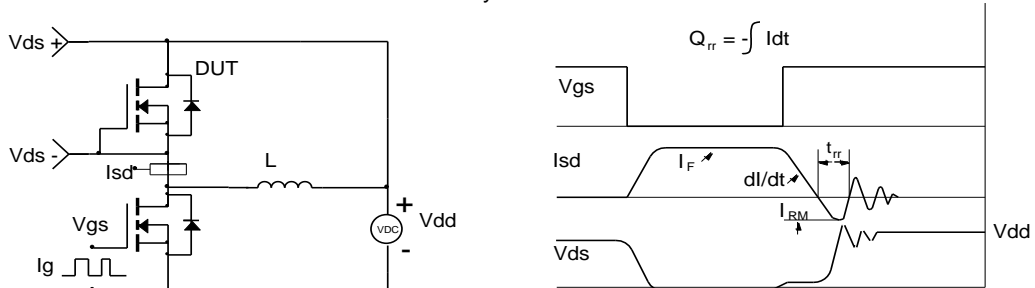

OUR CERTIFICATE

DiGi provide top-quality products and perfect service for customer worldwide through standardization, technological innovation and continuous improvement. DiGi through third-party certification, we stricly control the quality of products and services. Welcome your RFQ to

Email: Info@DiGi-Electronics.com



Tel: +00 852-30501935

RFQ Email: Info@DiGi-Electronics.com

DiGi is a global authorized distributor of electronic components.