

# CY2DP1504ZXCT Datasheet

[www.digi-electronics.com](http://www.digi-electronics.com)

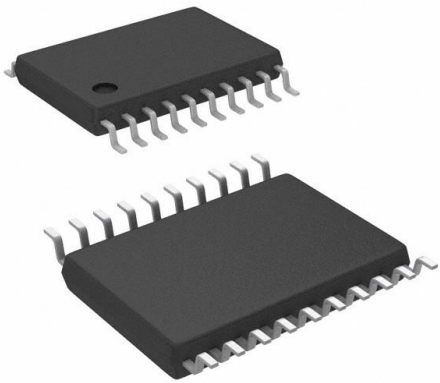

<https://www.DiGi-Electronics.com>

DiGi Electronics Part Number	CY2DP1504ZXCT-DG
Manufacturer	<a href="#">Infineon Technologies</a>
Manufacturer Product Number	CY2DP1504ZXCT
Description	IC CLK BUFFER 2:4 1.5GHZ 20TSSOP
Detailed Description	Clock Fanout Buffer (Distribution), Multiplexer IC 2:4 1.5 GHz 20-TSSOP (0.173", 4.40mm Width)



Tel: +00 852-30501935

RFQ Email: [Info@DiGi-Electronics.com](mailto:Info@DiGi-Electronics.com)

DiGi is a global authorized distributor of electronic components.

## Purchase and inquiry

Manufacturer Product Number:

CY2DP1504ZXCT

Series:

-

Type:

Fanout Buffer (Distribution), Multiplexer

Ratio - Input:Output:

2:4

Input:

LVPECL

Frequency - Max:

1.5 GHz

Operating Temperature:

0°C ~ 70°C

Package / Case:

20-TSSOP (0.173", 4.40mm Width)

Manufacturer:

Infineon Technologies

Product Status:

Obsolete

Number of Circuits:

1

Differential - Input:Output:

Yes/Yes

Output:

LVPECL

Voltage - Supply:

2.375V ~ 3.465V

Mounting Type:

Surface Mount

Supplier Device Package:

20-TSSOP

## Environmental & Export classification

RoHS Status:

ROHS3 Compliant

REACH Status:

REACH Unaffected

HTSUS:

8542.39.0001

Moisture Sensitivity Level (MSL):

3 (168 Hours)

ECCN:

EAR99



**CY2DP1504**

## 1:4 LVPECL Fanout Buffer with Selectable Clock Input

### Features

- Select one of two differential (LVPECL, LVDS, HCSL, or CML) input pairs to distribute to four LVPECL output pairs
- Translates any single-ended input signal to 3.3 V LVPECL levels with resistor bias on INx# input
- 30 ps maximum output-to-output skew
- 480 ps maximum propagation delay
- 0.15 ps maximum additive RMS phase jitter at 156.25 MHz (12 kHz to 20 MHz offset)
- Up to 1.5 GHz operation
- Synchronous clock enable function
- 20-pin TSSOP
- 2.5 V or 3.3 V operating voltage <sup>[1]</sup>
- Commercial and industrial operating temperature range

### Functional Description

The CY2DP1504 is an ultra-low noise, low-skew, low-propagation delay, 1:4 LVPECL fanout buffer targeted to meet the requirements of high-speed clock distribution applications. The CY2DP1504 can select between separate differential (LVPECL, LVDS, HCSL, or CML) input clock pairs using the IN\_SEL pin. The synchronous clock enable function ensures glitch-free output transitions during enable and disable periods. The device has a fully differential internal architecture that is optimized to achieve low additive jitter and low skew at operating frequencies of up to 1.5 GHz.

For a complete list of related documentation, [click here](#).

### Logic Block Diagram

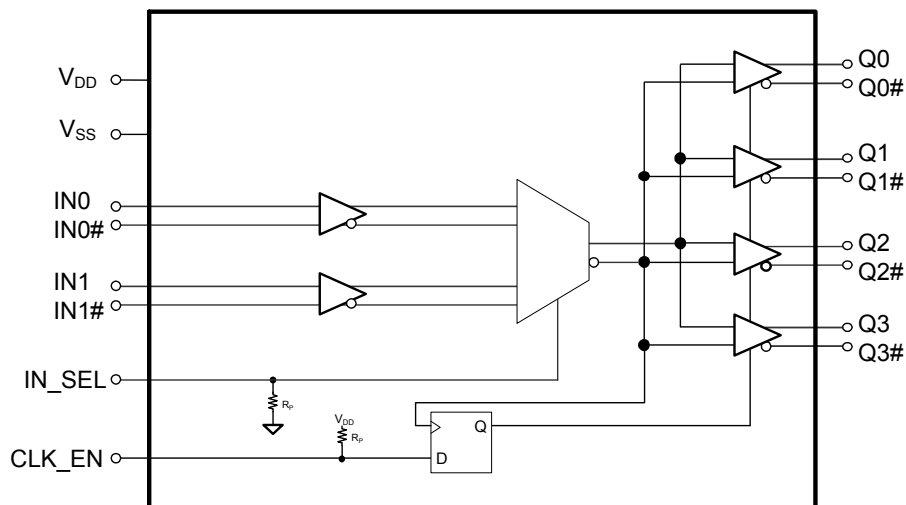

#### Note

1. Input AC-coupling capacitors are required for voltage-translation applications.



## Contents

<b>Pinouts</b> .....	<b>3</b>	<b>Acronyms</b> .....	<b>13</b>
<b>Pin Definitions</b> .....	<b>3</b>	<b>Document Conventions</b> .....	<b>13</b>
<b>Absolute Maximum Ratings</b> .....	<b>4</b>	Units of Measure .....	13
<b>Operating Conditions</b> .....	<b>4</b>	<b>Document History Page</b> .....	<b>14</b>
<b>DC Electrical Specifications</b> .....	<b>5</b>	<b>Sales, Solutions, and Legal Information</b> .....	<b>16</b>
<b>Thermal Resistance</b> .....	<b>5</b>	Worldwide Sales and Design Support .....	16
<b>AC Electrical Specifications</b> .....	<b>6</b>	Products .....	16
<b>Switching Waveforms</b> .....	<b>8</b>	PSoC@Solutions .....	16
<b>Application Information</b> .....	<b>10</b>	Cypress Developer Community .....	16
<b>Ordering Information</b> .....	<b>11</b>	Technical Support .....	16
Ordering Code Definitions .....	11		
<b>Package Diagram</b> .....	<b>12</b>		

## Pinouts

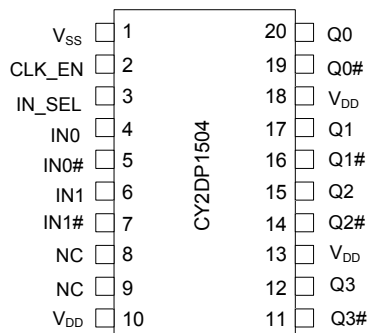
**Figure 1. 20-pin TSSOP pinout**

## Pin Definitions

Pin No.	Pin Name	Pin Type	Description
1	V <sub>SS</sub>	Power	Ground
2	CLK_EN	Input	Synchronous clock enable. LVCMOS/LVTTL. When CLK_EN = Low, Q(0:3) outputs are held Low and Q(0:3)# outputs are held High
3	IN_SEL	Input	Input clock select pin. LVCMOS/LVTTL; When IN_SEL = Low, the IN0/IN0# differential input pair is active When IN_SEL = High, the IN1/IN1# differential input pair is active
4	IN0	Input	Differential (LVPECL, HCSL, LVDS, or CML) input clock. Active when IN_SEL = Low
5	IN0#	Input	Differential (LVPECL, HCSL, LVDS, or CML) complementary input clock. Active when IN_SEL = Low
6	IN1	Input	Differential (LVPECL, HCSL, LVDS, or CML) input clock. Active when IN_SEL = High
7	IN1#	Input	Differential (LVPECL, HCSL, LVDS, or CML) complementary input clock. Active when IN_SEL = High
8, 9	NC		No connection
10, 13, 18	V <sub>DD</sub>	Power	Power supply
11, 14, 16, 19	Q(0:3)#	Output	LVPECL complementary output clocks
12, 15, 17, 20	Q(0:3)	Output	LVPECL output clocks



## Absolute Maximum Ratings

Parameter	Description	Condition	Min	Max	Unit
$V_{DD}$	Supply voltage	Non functional	-0.5	4.6	V
$V_{IN}^{[2]}$	Input voltage, relative to $V_{SS}$	Non functional	-0.5	Lesser of 4.0 or $V_{DD} + 0.4$	V
$V_{OUT}^{[2]}$	DC output or I/O voltage, relative to $V_{SS}$	Non functional	-0.5	Lesser of 4.0 or $V_{DD} + 0.4$	V
$T_S$	Storage temperature	Non functional	-55	150	°C
$ESD_{HBM}$	Electrostatic discharge (ESD) protection (Human body model)	JEDEC STD 22-A114-B	2000	-	V
$L_U$	Latch up		Meets or exceeds JEDEC Spec JESD78B IC Latch up Test		
UL-94	Flammability rating	At 1/8 in	V-0		
MSL	Moisture sensitivity level		3		

## Operating Conditions

Parameter	Description	Condition	Min	Max	Unit
$V_{DD}$	Supply voltage	2.5-V supply	2.375	2.625	V
		3.3-V supply	3.135	3.465	V
$T_A$	Ambient operating temperature	Commercial	0	70	°C
		Industrial	-40	85	°C
$t_{PU}$	Power ramp time	Power-up time for $V_{DD}$ to reach minimum specified voltage (power ramp must be monotonic).	0.05	500	ms

### Note

2. The voltage on any I/O pin cannot exceed the power pin during power up. Power supply sequencing is not required.



## DC Electrical Specifications

( $V_{DD} = 3.3\text{ V} \pm 5\%$  or  $2.5\text{ V} \pm 5\%$ ;  $T_A = 0\text{ }^{\circ}\text{C}$  to  $70\text{ }^{\circ}\text{C}$  (Commercial) or  $-40\text{ }^{\circ}\text{C}$  to  $85\text{ }^{\circ}\text{C}$  (Industrial))

Parameter	Description	Condition	Min	Max	Unit
$I_{DD}$	Operating supply current	All LVPECL outputs floating (internal $I_{DD}$ )	–	61	mA
$V_{IH1}$	Input high voltage, differential input clocks IN0 and IN0#, IN1 and IN1#		–	$V_{DD} + 0.3$	V
$V_{IL1}$	Input low voltage, differential input clocks IN0 and IN0#, IN1 and IN1#		–0.3	–	V
$V_{IH2}$	Input high voltage, CLK_EN, IN_SEL	$V_{DD} = 3.3\text{ V}$	2.0	$V_{DD} + 0.3$	V
$V_{IL2}$	Input low voltage, CLK_EN, IN_SEL	$V_{DD} = 3.3\text{ V}$	–0.3	0.8	V
$V_{IH3}$	Input high voltage, CLK_EN, IN_SEL	$V_{DD} = 2.5\text{ V}$	1.7	$V_{DD} + 0.3$	V
$V_{IL3}$	Input low voltage, CLK_EN, IN_SEL	$V_{DD} = 2.5\text{ V}$	–0.3	0.7	V
$V_{ID\_LDVS}^{[3]}$	LVDS input differential amplitude	See <a href="#">Figure 2 on page 8</a>	0.4	0.8	V
$V_{ID\_LVPECL}^{[3]}$	LVPECL/CML/HSCL input differential amplitude	See <a href="#">Figure 2 on page 8</a>	0.4	1.0	V
$V_{ICM}$	Input common mode voltage	See <a href="#">Figure 2 on page 8</a>	0.2	$V_{DD} - 0.2$	V
$I_{IH}$	Input high current, all inputs	Input = $V_{DD}^{[4]}$	–	150	$\mu\text{A}$
$I_{IL}$	Input low current, all inputs	Input = $V_{SS}^{[4]}$	–150	–	$\mu\text{A}$
$V_{OH}$	LVPECL output high voltage	Terminated with $50\ \Omega$ to $V_{DD} - 2.0^{[5]}$	$V_{DD} - 1.20$	$V_{DD} - 0.70$	V
$V_{OL}$	LVPECL output low voltage	Terminated with $50\ \Omega$ to $V_{DD} - 2.0^{[5]}$	$V_{DD} - 2.0$	$V_{DD} - 1.63$	V
$R_P$	Internal pull-up/pull-down resistance, LVCMOS logic inputs	CLK_EN has pull-up only IN_SEL has pull-down only	60	165	$\text{k}\Omega$
$C_{IN}$	Input capacitance	Measured at 10 MHz; per pin	–	3	pF

## Thermal Resistance

Parameter <sup>[6]</sup>	Description	Test Conditions	20-pin TSSOP	Unit
$\theta_{JA}$	Thermal resistance (junction to ambient)	Test conditions follow standard test methods and procedures for measuring thermal impedance, in accordance with EIA/JESD51.	80	$^{\circ}\text{C}/\text{W}$
$\theta_{JC}$	Thermal resistance (junction to case)		16	$^{\circ}\text{C}/\text{W}$

### Notes

- $V_{ID}$  minimum of 400 mV is required to meet all output AC Electrical Specifications. The device is functional with  $V_{ID}$  minimum of greater than 200 mV.
- Positive current flows into the input pin, negative current flows out of the input pin.
- Refer to [Figure 3 on page 8](#).
- These parameters are guaranteed by design and are not tested.



## AC Electrical Specifications

( $V_{DD} = 3.3\text{ V} \pm 5\%$  or  $2.5\text{ V} \pm 5\%$ ;  $T_A = 0\text{ }^\circ\text{C}$  to  $70\text{ }^\circ\text{C}$  (Commercial) or  $-40\text{ }^\circ\text{C}$  to  $85\text{ }^\circ\text{C}$  (Industrial))

Parameter	Description	Condition	Min	Typ	Max	Unit
$F_{IN}$	Input frequency	Differential Input	DC	–	1.5	GHz
		Single-ended CMOS Input <sup>[7]</sup>	DC	–	250	MHz
$F_{OUT}$	Output frequency	$F_{OUT} = F_{IN}$ , Differential Input	DC	–	1.5	GHz
		$F_{OUT} = F_{IN}$ , Single-ended CMOS Input <sup>[7]</sup>	DC	–	250	MHz
$V_{PP}$	LVPECL differential output voltage peak to peak, single-ended. Terminated with $50\ \Omega$ to $V_{DD} - 2.0$ <sup>[8]</sup>	$F_{out} = \text{DC to } 150\text{ MHz}$	600	–	–	mV
		$F_{out} = >150\text{ MHz to } 1.5\text{ GHz}$	400	–	–	mV
$t_{PD}$ <sup>[9]</sup>	Propagation delay differential input pair to differential output pair	Input rise/fall time $< 1.5\text{ ns}$ (20% to 80%)	–	–	480	ps
$t_{ODC}$ <sup>[10]</sup>	Output duty cycle	50% duty cycle at input, Frequency range up to 1 GHz, Differential input	48	–	52	%
		50% duty cycle at input, Frequency range up to 250 MHz, Single-ended CMOS input <sup>[7]</sup>	45	–	55	%
$t_{SK1}$ <sup>[11]</sup>	Output-to-output skew	Any output to any output, with same load conditions at DUT	–	–	30	ps
$t_{SK1D}$ <sup>[11]</sup>	Device-to-device output skew	Any output to any output between two or more devices. Devices must have the same input and have the same output load.	–	–	150	ps
$PN_{ADD}$	Additive RMS phase noise, 156.25-MHz input, Rise/fall time $< 150\text{ ps}$ (20% to 80%), $V_{ID} > 400\text{ mV}$ or Input Swing = $3.0\text{ V}$ <sup>[7]</sup>	Offset = 1 kHz	–	–	–120	dBc/Hz
		Offset = 10 kHz	–	–	–130	dBc/Hz
		Offset = 100 kHz	–	–	–135	dBc/Hz
		Offset = 1 MHz	–	–	–145	dBc/Hz
		Offset = 10 MHz	–	–	–153	dBc/Hz
		Offset = 20 MHz	–	–	–155	dBc/Hz

### Notes

7. Refer to [Application Information](#) on page 10.
8. Refer to [Figure 3](#) on page 8.
9. Refer to [Figure 4](#) on page 8.
10. Refer to [Figure 5](#) on page 8.
11. Refer to [Figure 6](#) on page 9.





## AC Electrical Specifications (continued)

( $V_{DD} = 3.3\text{ V} \pm 5\%$  or  $2.5\text{ V} \pm 5\%$ ;  $T_A = 0\text{ }^\circ\text{C}$  to  $70\text{ }^\circ\text{C}$  (Commercial) or  $-40\text{ }^\circ\text{C}$  to  $85\text{ }^\circ\text{C}$  (Industrial))

Parameter	Description	Condition	Min	Typ	Max	Unit
$t_{JIT}^{[12]}$	Additive RMS phase jitter (random)	156.25 MHz, 12 kHz to 20 MHz offset; input rise/fall time < 150 ps (20% to 80%), $V_{ID} > 400\text{ mV}$	–	–	0.15	ps
		156.25 MHz Sinewave, 12 kHz to 20 MHz offset, input rise/fall time < 150 ps (20% to 80%), Input Swing = $3.0\text{ V}^{[13]}$	–	–	0.15	ps
$t_R, t_F^{[14]}$	Output rise/fall time	50% duty cycle at input, 20% to 80% of full swing ( $V_{OL}$ to $V_{OH}$ ) Input rise/fall time < 1.5 ns (20% to 80%)	–	–	300	ps
$t_{SOD}$	Time from clock edge to outputs disabled	Synchronous clock enable (CLK_EN) switched Low	–	–	700	ps
$t_{SOE}$	Time from clock edge to outputs enabled	Synchronous clock enable (CLK_EN) switched High	–	–	700	ps

### Notes

12. Refer to [Figure 7](#) on page 9.

13. Refer to [Application Information](#) on page 10.

14. Refer to [Figure 8](#) on page 9.

## Switching Waveforms

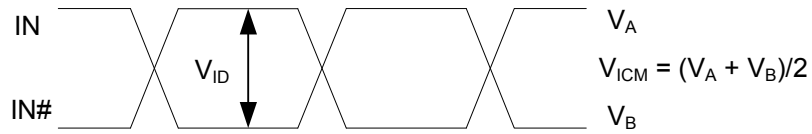
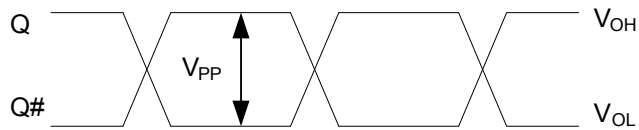
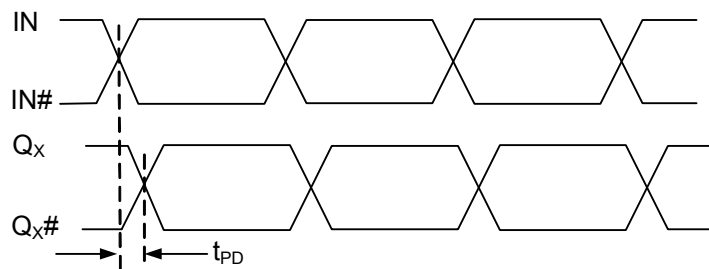
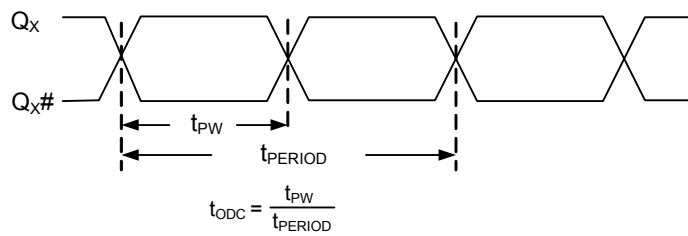
**Figure 2. Input Differential and Common Mode Voltages****Figure 3. Output Differential Voltage****Figure 4. Input to Any Output Pair Propagation Delay****Figure 5. Output Duty Cycle**



Switching Waveforms (continued)

Figure 6. Output-to-Output and Device-to-Device Skew

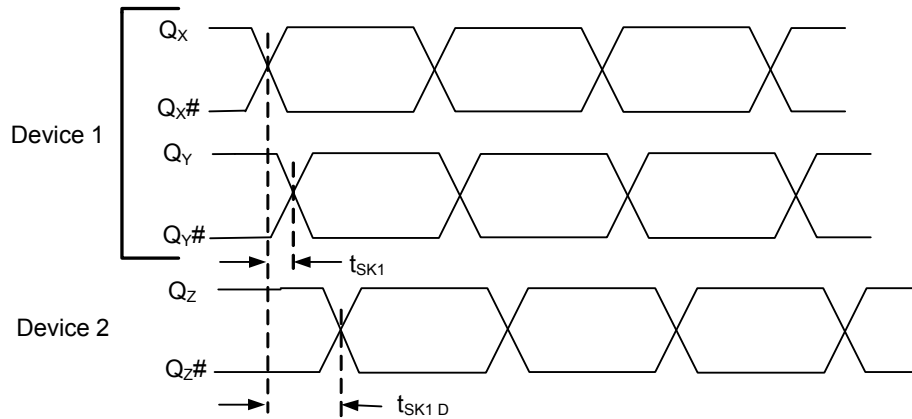

Figure 7. RMS Phase Jitter

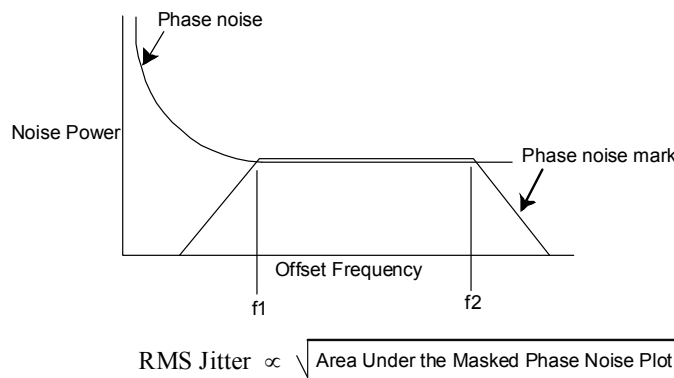

Figure 8. Output Rise/Fall Time

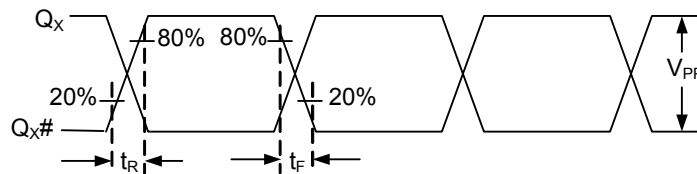
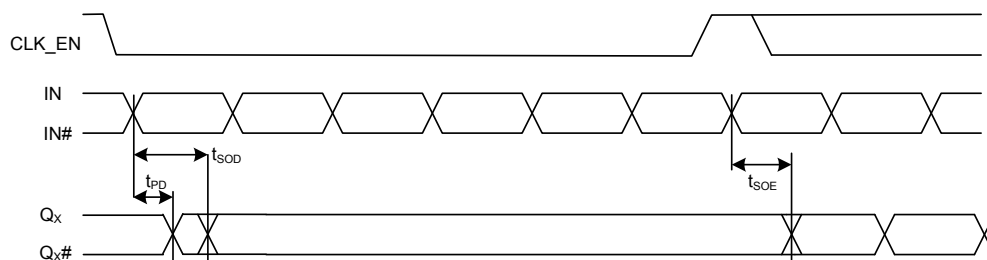

Figure 9. Synchronous Clock Enable Timing



## Application Information

CY2DP1504 can be used with a single-ended CMOS input by biasing the Complementary Input Clock (INx#). “True” input pins (INx) of differential input pair can be fed with a single-ended CMOS input signal. The “complementary” input pin (INx#) of the same differential input pair can be biased with Vref.

Figure 10 shows the schematic which can be used to give single-ended CMOS input to the CY2DP1504.

The reference voltage  $V_{ref} = VDD/2$  is generated by the bias resistors R1, R2 and capacitor C0. This bias circuit should be located as close as possible to the input pin. The ratio of R1 and R2 might need to be adjusted to position the Vref in the center of the input voltage swing. For example, if the input clock swing is 2.5 V and  $VDD = 3.3$  V,  $V_{ref}$  should be 1.25 V and  $R2/R1 = 0.609$ .

**Figure 10. Application Example**

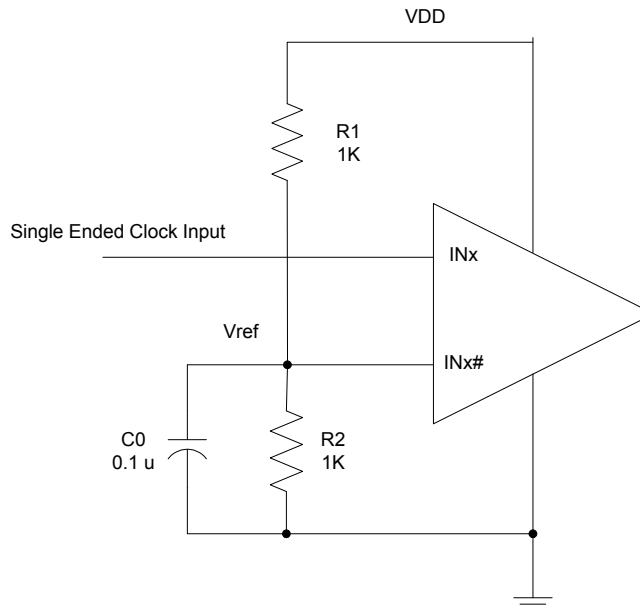



## Ordering Information

Part Number	Type	Production Flow
<b>Pb-free</b>		
CY2DP1504ZXC	20-pin TSSOP	Commercial, 0 °C to 70 °C
CY2DP1504ZXCT	20-pin TSSOP – Tape and Reel	Commercial, 0 °C to 70 °C
CY2DP1504ZXI	20-pin TSSOP	Industrial, –40 °C to 85 °C
CY2DP1504ZXIT	20-pin TSSOP – Tape and Reel	Industrial, –40 °C to 85 °C

## Ordering Code Definitions

CY 2DP15 04 Z X X X

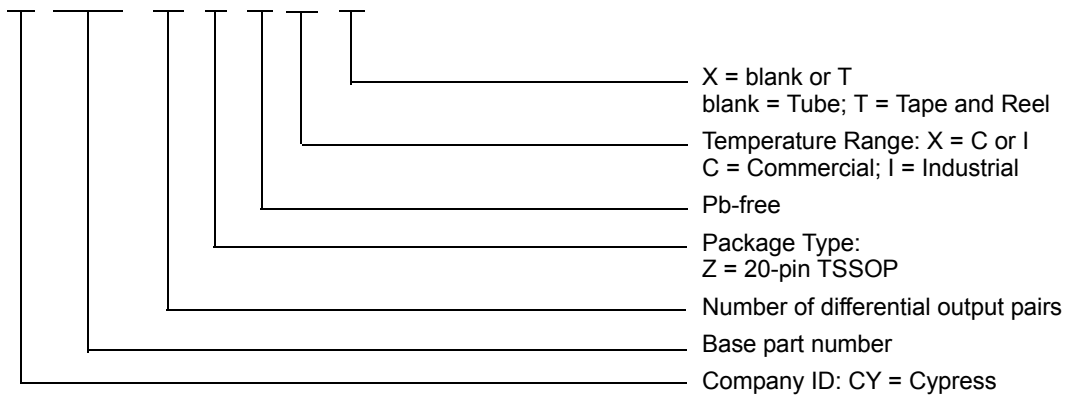





**Package Diagram**

**Figure 11. 20-pin TSSOP 4.40 mm Body Z20.173/ZZ20.173 Package Outline, 51-85118**  
 20 Lead TSSOP 4.40 MM BODY

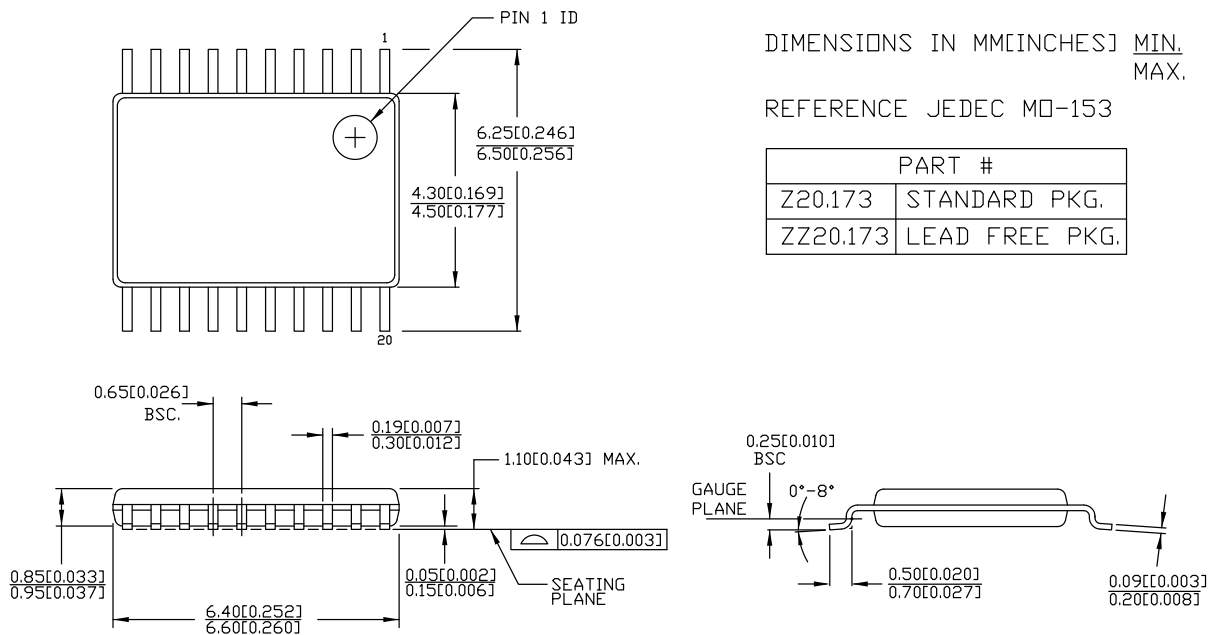

51-85118 \*E



## Acronyms

Acronym	Description
ESD	electrostatic discharge
HBM	human body model
HCSL	high-speed current steering logic
JEDEC	joint electron devices engineering council
LVC MOS	low-voltage complementary metal oxide semiconductor
LVPECL	low-voltage positive emitter-coupled logic
LVTTTL	low-voltage transistor-transistor logic
RMS	root mean square
TSSOP	thin shrunk small outline package

## Document Conventions

### Units of Measure

Symbol	Unit of Measure
°C	degree Celsius
dBc	decibels relative to the carrier
GHz	gigahertz
Hz	hertz
kΩ	kilohm
μA	microampere
μF	microfarad
μs	microsecond
mA	milliampere
ms	millisecond
mV	millivolt
MHz	megahertz
ns	nanosecond
Ω	ohm
pF	picofarad
ps	picosecond
V	volt
W	watt



## Document History Page

Document Title: CY2DP1504, 1:4 LVPECL Fanout Buffer with Selectable Clock Input				
Document Number: 001-56215				
Revision	ECN	Orig. of Change	Submission Date	Description of Change
**	2782891	CXQ	10/09/09	New data sheet.
*A	2838916	CXQ	01/05/2010	<p>Changed status from "ADVANCE" to "PRELIMINARY".</p> <p>Changed from 0.34 ps to 0.25 ps maximum additive jitter in "Features" on page 1 and in <math>t_{JIT}</math> in the AC Electrical Specs table on page 5.</p> <p>Added <math>t_{PU}</math> spec to the Operating Conditions table on page 3.</p> <p>Changed max <math>I_{DD}</math> spec in the DC Electrical Specs table on page 4 from 60 mA to 61 mA.</p> <p>Change <math>V_{OH}</math> in the DC Electrical Specs table on page 4: minimum from <math>V_{DD} - 1.15V</math> to <math>V_{DD} - 1.20V</math>; maximum from <math>V_{DD} - 0.75V</math> to <math>V_{DD} - 0.70V</math>.</p> <p>Removed <math>V_{OD}</math> spec from the DC Electrical Specs table on page 4.</p> <p>Added <math>R_P</math> spec in the DC Electrical Specs table on page 4. Min = 60 k<math>\Omega</math>, Max = 140 k<math>\Omega</math>.</p> <p>Added a measurement definition for <math>C_{IN}</math> in the DC Electrical Specs table on page 4.</p> <p>Added <math>V_{PP}</math> spec to the AC Electrical Specs table on page 5. <math>V_{PP}</math> min = 600 mV for DC - 150 MHz and min = 400 mV for 150 MHz to 1.5 GHz.</p> <p>Changed letter case and some names of all the timing parameters in the AC Electrical Specs table on page 5 to be consistent with EROS.</p> <p>Lowered all additive phase noise mask specs by 3 dB in the AC Electrical Specs table on page 5.</p> <p>Added condition to <math>t_R</math> and <math>t_F</math> specs in the AC Electrical specs table on page 5 that input rise/fall time must be less than 1.5 ns (20% to 80%).</p> <p>Changed letter case and some names of all the timing parameters in Figures 3, 4, 5, 6 and 8, to be consistent with EROS.</p>
*B	3011766	CXQ	08/20/2010	<p>Changed maximum additive jitter from 0.25 ps to 0.11 ps in "Features" on page 1 and in <math>t_{JIT}</math> in the AC Electrical Specs table.</p> <p>Added note 3 to describe <math>I_{IH}</math> and <math>I_{IL}</math> specs.</p> <p>Removed reference to data distribution from "Functional Description".</p> <p>Changed <math>R_P</math> for differential inputs from 100 k<math>\Omega</math> to 150 k<math>\Omega</math> in the Logic Block Diagram and from 60 k<math>\Omega</math> min / 140 k<math>\Omega</math> max to 90 k<math>\Omega</math> min / 210 k<math>\Omega</math> max in the DC Electrical Specs table.</p> <p>Added max <math>V_{ID}</math> of 1.0V in DC Electrical Specs table.</p> <p>Updated phase noise specs for 1 k/10 k/100 k/1 M/10 M/20 MHz offset to -120/-130/-135/-150/-150/-150dBc/Hz, respectively, in the AC Electrical Specs table.</p> <p>Added "Frequency range up to 1 GHz" condition to <math>t_{ODC}</math> spec.</p> <p>Added Ordering Code Definition.</p> <p>Updated package diagram.</p> <p>Added Acronyms.</p>
*C	3017258	CXQ	08/27/2010	Corrected Output Rise/Fall time diagram.
*D	3100234	CXQ	11/18/2010	<p>Updated Phase jitter to 0.15ps max from 0.11ps max.</p> <p>Changed <math>V_{IN}</math> and <math>V_{OUT}</math> specs from 4.0V to "lesser of 4.0 or <math>V_{DD} + 0.4</math>"</p> <p>Removed 200mA min LU spec, replaced with "Meets or exceeds JEDEC Spec JESD78B IC Latchup Test"</p> <p>Removed <math>R_P</math> spec for differential input clock pins <math>IN_X</math> and <math>IN_X\#</math>.</p> <p>Changed <math>C_{IN}</math> condition to "Measured at 10 MHz".</p> <p>Changed <math>PN_{ADD}</math> specs for 1MHz, 10MHz, and 20MHz offsets.</p> <p>Removed <math>t_S</math> and <math>t_H</math> specs from AC specs table.</p>
*E	3135201	CXQ	01/12/2011	<p>Removed "Preliminary" status heading.</p> <p>Removed resistors from <math>IN_X/IN_X\#</math> in <a href="#">Logic Block Diagram</a>.</p> <p>Added <a href="#">Figure 9</a> to describe <math>T_{SOE}</math> and <math>T_{SOD}</math>.</p>
*F	3090938	CXQ	02/25/2011	Post to external web.



## Document History Page (continued)

Document Title: CY2DP1504, 1:4 LVPECL Fanout Buffer with Selectable Clock Input Document Number: 001-56215				
Revision	ECN	Orig. of Change	Submission Date	Description of Change
*G	3208968	CXQ	03/29/2011	Changed $R_P$ max from 140 k $\Omega$ to 165 k $\Omega$ and updated $R_P$ in <a href="#">Logic Block Diagram</a> .
*H	3308039	CXQ	07/11/2011	Updated supported differential input clock types to include LVPECL/LVDS/CML in Features, Functional Description, Pin Definitions, and DC specs table sections. Broke out $V_{ID}$ spec into $V_{ID\_LVDS}$ and $V_{ID\_LVPECL}$ specs.
*I	3395868	PURU	10/05/11	Updated supported differential input clock types to include HCSSL in <a href="#">Features</a> , <a href="#">Pinouts</a> , and <a href="#">DC Electrical Specifications</a> table. Changed Min value of $V_{ICM}$ .
*J	3740406	CINM	09/11/2012	Minor text edits.
*K	3799048	PURU	12/05/2012	Updated <a href="#">Features</a> : Added "Translates any single-ended input signal to 3.3 V LVPECL levels with resistor bias on INx# input". Updated <a href="#">AC Electrical Specifications</a> : Added Note 7 and Note 13. Added $F_{IN}$ parameter values for "Single Ended CMOS Input" condition (Minimum value = DC, Maximum value = 250 MHz). Added $F_{OUT}$ parameter values for "Single Ended CMOS Input" condition (Minimum value = DC, Maximum value = 250 MHz). Updated $t_{PD}$ parameter (Changed description from "Propagation delay input pair to output pair" to "Propagation delay differential input pair to differential output pair"). Added $t_{ODC}$ parameter values for "Single Ended CMOS Input" condition (Minimum value = 45%, Maximum value = 55%). Updated description of $PN_{ADD}$ parameter (Replaced "Additive RMS phase noise, 156.25-MHz input, Rise/fall time < 150 ps (20% to 80%), $V_{ID} > 400$ mV" with "Additive RMS phase noise, 156.25-MHz input, Rise/fall time < 150 ps (20% to 80%), $V_{ID} > 400$ mV or Input Swing = 3.0 V <sup>[7]</sup> "). Added $t_{JIT}$ parameter values for the Condition "156.25 MHz Sinewave, 12 kHz to 20 MHz offset, input rise/fall time < 150 ps (20% to 80%), Input Swing = 3.0 V <sup>[13]</sup> " (Maximum value = 0.15 ps). Added <a href="#">Application Information</a> . Updated to new template.
*L	4586288	PURU	12/04/2014	Updated <a href="#">Functional Description</a> : Added "For a complete list of related documentation, <a href="#">click here</a> ." at the end. Updated <a href="#">Package Diagram</a> : spec 51-85118 – Changed revision from *D to *E.
*M	4959240	TAVA	10/12/2015	Updated to new template. Completing Sunset Review.
*N	5267558	PSR	05/13/2016	Added <a href="#">Thermal Resistance</a> . Updated to new template.



## Sales, Solutions, and Legal Information

### Worldwide Sales and Design Support

Cypress maintains a worldwide network of offices, solution centers, manufacturer's representatives, and distributors. To find the office closest to you, visit us at [Cypress Locations](#).

#### Products

ARM® Cortex® Microcontrollers	<a href="http://cypress.com/arm">cypress.com/arm</a>
Automotive	<a href="http://cypress.com/automotive">cypress.com/automotive</a>
Clocks & Buffers	<a href="http://cypress.com/clocks">cypress.com/clocks</a>
Interface	<a href="http://cypress.com/interface">cypress.com/interface</a>
Lighting & Power Control	<a href="http://cypress.com/powerpsoc">cypress.com/powerpsoc</a>
Memory	<a href="http://cypress.com/memory">cypress.com/memory</a>
PSoC	<a href="http://cypress.com/psoc">cypress.com/psoc</a>
Touch Sensing	<a href="http://cypress.com/touch">cypress.com/touch</a>
USB Controllers	<a href="http://cypress.com/usb">cypress.com/usb</a>
Wireless/RF	<a href="http://cypress.com/wireless">cypress.com/wireless</a>

#### PSoC® Solutions

[PSoC 1](#) | [PSoC 3](#) | [PSoC 4](#) | [PSoC 5LP](#)

#### Cypress Developer Community

[Forums](#) | [Projects](#) | [Video](#) | [Blogs](#) | [Training](#) | [Components](#)

#### Technical Support

[cypress.com/support](http://cypress.com/support)

© Cypress Semiconductor Corporation, 2009-2016. This document is the property of Cypress Semiconductor Corporation and its subsidiaries, including Spansion LLC ("Cypress"). This document, including any software or firmware included or referenced in this document ("Software"), is owned by Cypress under the intellectual property laws and treaties of the United States and other countries worldwide. Cypress reserves all rights under such laws and treaties and does not, except as specifically stated in this paragraph, grant any license under its patents, copyrights, trademarks, or other intellectual property rights. If the Software is not accompanied by a license agreement and you do not otherwise have a written agreement with Cypress governing the use of the Software, then Cypress hereby grants you a personal, non-exclusive, nontransferable license (without the right to sublicense) (1) under its copyright rights in the Software (a) for Software provided in source code form, to modify and reproduce the Software solely for use with Cypress hardware products, only internally within your organization, and (b) to distribute the Software in binary code form externally to end users (either directly or indirectly through resellers and distributors), solely for use on Cypress hardware product units, and (2) under those claims of Cypress's patents that are infringed by the Software (as provided by Cypress, unmodified) to make, use, distribute, and import the Software solely for use with Cypress hardware products. Any other use, reproduction, modification, translation, or compilation of the Software is prohibited.

TO THE EXTENT PERMITTED BY APPLICABLE LAW, CYPRESS MAKES NO WARRANTY OF ANY KIND, EXPRESS OR IMPLIED, WITH REGARD TO THIS DOCUMENT OR ANY SOFTWARE OR ACCOMPANYING HARDWARE, INCLUDING, BUT NOT LIMITED TO, THE IMPLIED WARRANTIES OF MERCHANTABILITY AND FITNESS FOR A PARTICULAR PURPOSE. To the extent permitted by applicable law, Cypress reserves the right to make changes to this document without further notice. Cypress does not assume any liability arising out of the application or use of any product or circuit described in this document. Any information provided in this document, including any sample design information or programming code, is provided only for reference purposes. It is the responsibility of the user of this document to properly design, program, and test the functionality and safety of any application made of this information and any resulting product. Cypress products are not designed, intended, or authorized for use as critical components in systems designed or intended for the operation of weapons, weapons systems, nuclear installations, life-support devices or systems, other medical devices or systems (including resuscitation equipment and surgical implants), pollution control or hazardous substances management, or other uses where the failure of the device or system could cause personal injury, death, or property damage ("Unintended Uses"). A critical component is any component of a device or system whose failure to perform can be reasonably expected to cause the failure of the device or system, or to affect its safety or effectiveness. Cypress is not liable, in whole or in part, and you shall and hereby do release Cypress from any claim, damage, or other liability arising from or related to all Unintended Uses of Cypress products. You shall indemnify and hold Cypress harmless from and against all claims, costs, damages, and other liabilities, including claims for personal injury or death, arising from or related to any Unintended Uses of Cypress products.

Cypress, the Cypress logo, Spansion, the Spansion logo, and combinations thereof, PSoC, CapSense, EZ-USB, F-RAM, and Traveo are trademarks or registered trademarks of Cypress in the United States and other countries. For a more complete list of Cypress trademarks, visit [cypress.com](http://cypress.com). Other names and brands may be claimed as property of their respective owners.



## OUR CERTIFICATE

DiGi provide top-quality products and perfect service for customer worldwide through standardization, technological innovation and continuous improvement. DiGi through third-party certification, we strictly control the quality of products and services. Welcome your RFQ to

Email: [Info@DiGi-Electronics.com](mailto:Info@DiGi-Electronics.com)



Tel: +00 852-30501935

RFQ Email: [Info@DiGi-Electronics.com](mailto:Info@DiGi-Electronics.com)

DiGi is a global authorized distributor of electronic components.