

CY7C65621-56LTXCT Datasheet



<https://www.DiGi-Electronics.com>

DiGi Electronics Part Number	CY7C65621-56LTXCT-DG
Manufacturer	Infineon Technologies
Manufacturer Product Number	CY7C65621-56LTXCT
Description	IC USB CTRL 2.0 2-PORT AEC 56QFN
Detailed Description	USB Hub Controller USB 2.0 USB Interface 56-QFN (8x8)

This model CY7C65621-56LTXCT is available at DiGi Electronics.

DiGi Electronics offers a global database of semiconductor and electronic component datasheets.

We welcome your inquiries regarding pricing, lead time, or other product-related questions.

 [Request a Quote](#)

 [Datasheet Search](#)



Tel: +00 852-30501935

RFQ Email: Info@DiGi-Electronics.com

DiGi is a global authorized distributor of electronic components.

Purchase and inquiry

Manufacturer Product Number:

CY7C65621-56LTXCT

Series:

EZ-USB HX2LP Lite™

DiGi-Electronics Programmable:

Not Verified

Function:

Hub Controller

Standards:

USB 2.0

Current - Supply:

-

Package / Case:

56-VFQFN Exposed Pad

Base Product Number:

CY7C65621

Manufacturer:

Infineon Technologies

Product Status:

Active

Protocol:

USB

Interface:

USB

Voltage - Supply:

3.15V ~ 3.45V

Operating Temperature:

0°C ~ 70°C

Supplier Device Package:

56-QFN (8x8)

Environmental & Export classification

RoHS Status:

ROHS3 Compliant

REACH Status:

REACH Unaffected

HTSUS:

8542.31.0001

Moisture Sensitivity Level (MSL):

3 (168 Hours)

ECCN:

EAR99



Please note that Cypress is an Infineon Technologies Company.

The document following this cover page is marked as “Cypress” document as this is the company that originally developed the product. Please note that Infineon will continue to offer the product to new and existing customers as part of the Infineon product portfolio.

Continuity of document content

The fact that Infineon offers the following product as part of the Infineon product portfolio does not lead to any changes to this document. Future revisions will occur when appropriate, and any changes will be set out on the document history page.

Continuity of ordering part numbers

Infineon continues to support existing part numbers. Please continue to use the ordering part numbers listed in the datasheet for ordering.



CY7C65621/31

EZ-USB HX2LP Lite™ Low Power USB 2.0 Hub Controller Family

Features

- USB 2.0 hub controller
- Automotive and Industrial Grade option (-40 °C to 85 °C)
- Compliant with the USB 2.0 specification
- USB-IF certified: TID# 30000009
- Windows Hardware Quality Lab (WHQL) compliant
- Up to four downstream ports supported
- Supports bus powered and self powered modes
- Single transaction translator (TT)
- Bus power configurations
- Fit, form, and function compatible with CY7C65640 and CY7C65640A (TetraHub™)
- Space saving 56-pin QFN
- Single power supply requirement
 - Internal regulator for reduced cost
- Integrated upstream pull-up resistor
- Integrated pull-down resistors for all downstream ports
- Integrated upstream and downstream termination resistors
- Integrated port status indicator control
- 24 MHz external crystal (integrated phase locked loop (PLL))
- In-system EEPROM programming
- Configurable with external SPI EEPROM:
 - Vendor ID, Product ID, Device ID (VID/PID/DID)
 - Number of active ports
 - Number of removable ports
 - Maximum power setting for high speed and full speed
 - Hub controller power setting
 - Power on timer
 - Overcurrent detection mode
 - Enabled and disabled overcurrent timer
 - Overcurrent pin polarity
 - Indicator pin polarity
 - Compound device
 - Enable full speed only
 - Disable port indicators
 - Ganged power switching
 - Self and bus powered compatibility
 - Fully configurable string descriptors for multiple language support



Functional Description

EZ-USB HX2LP Lite™ is Cypress's next generation family of high performance, low power USB 2.0 hub controllers. HX2LP Lite is an ultra low power single chip USB 2.0 hub controller with integrated upstream and downstream transceivers, a USB Serial Interface Engine (SIE), USB Hub Control and Repeater logic, and Transaction Translator (TT) logic. Cypress has also integrated many external passive components such as pull up and pull down resistors, reducing the overall bill of materials required to implement a hub design. The HX2LP portfolio consists of:

1. CY7C65631: 4-port/single transaction translator

This device option is for ultra low power applications that require four downstream ports. All four ports share a single transaction translator. The CY7C65631 is available in a 56 QFN and is also pin-for-pin compatible with the CY7C65640.

2. CY7C65621:

This device option is for a 2-port bus powered application. Both ports share a single transaction translator. The CY7C65621 is available in a 56 QFN.

All device options are supported by Cypress's world-class reference design kits, which include board schematics, bill of materials, Gerber files, Orcad files, and thorough design documentation.

USB Serial Interface Engine

The Serial Interface Engine (SIE) allows the CY7C65621/31 to communicate with the USB host. The SIE handles the following USB activity independently of the Hub Control Block.

- Bit stuffing/unstuffing
- Checksum generation/checking
- TOKEN type identification
- Address checking.

Hub Repeater

The Hub Repeater manages connectivity between upstream and downstream facing ports that are operating at the same speed. It supports full speed, low speed, and high speed connectivity.

According to the USB 2.0 specification, the HUB Repeater provides the following functions:

- Sets up and tears down connectivity on packet boundaries
- Ensures orderly entry into and out of the Suspend state, including proper handling of remote wakeups.

Transaction Translator

The Transaction Translator (TT) basically translates data from one speed to another. A TT takes high speed split transactions and translates them to full or low speed transactions when the hub is operating at high speed (the upstream port is connected to a high speed host controller) and has a full or low speed devices attached. The operating speed of a device attached on a downstream facing port determines whether the Routing Logic connects a port to the Transaction Translator or Hub Repeater. If a full or low speed device is connected to the hub operating at high speed, the data transfer route includes the Transaction Translator. If a high speed device is connected to this high speed hub, the route only includes the repeater and no Transaction Translator because the device and the hub operate at the same speed. When the hub is operating at full speed (the upstream port is connected to a full speed host controller), a high speed peripheral does not operate at its full capability. These devices only work at full speed. Full and low speed devices connected to this hub operate at their normal speed.

Applications

Typical applications for the HX2LP Lite device family are:

- Standalone hubs
- Motherboard hubs
- Monitor hubs
- Advanced port replicators
- Docking stations
- Split-PC designs
- External personal storage drives
- Keyboard hubs



Block Diagram – CY7C65631

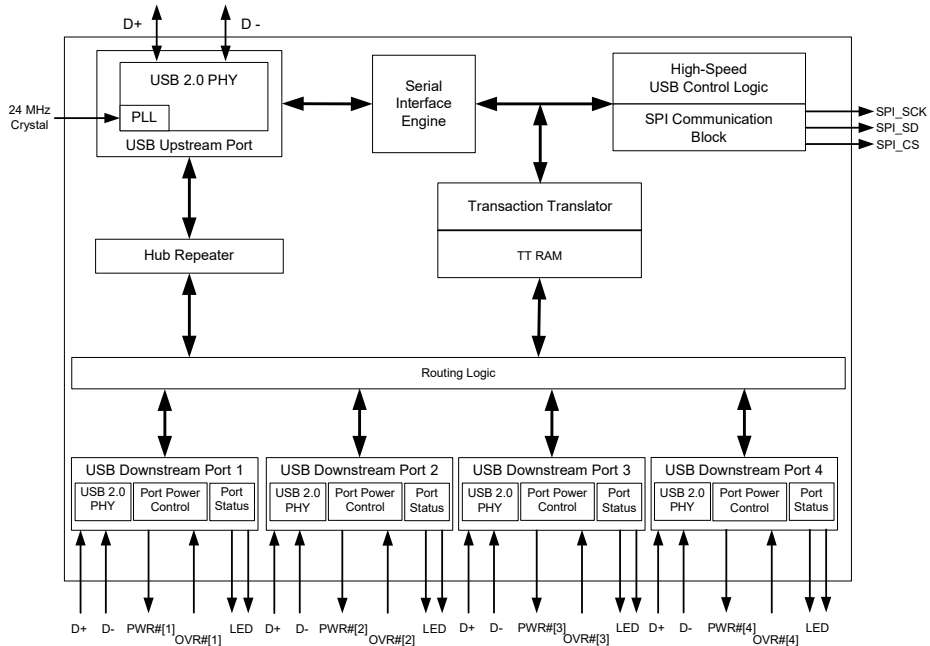

Block Diagram – CY7C65621

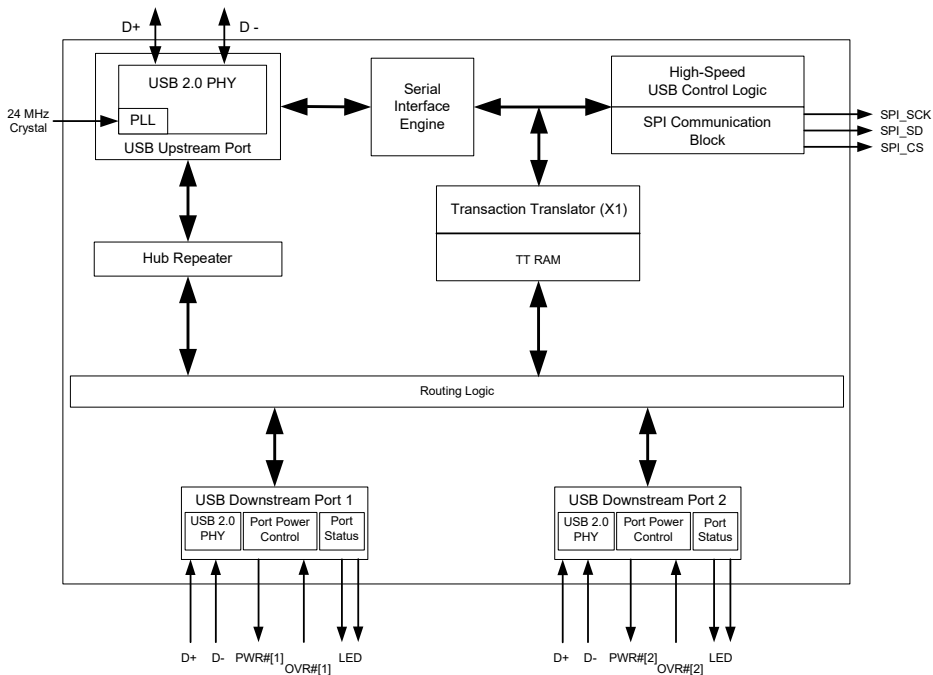



Contents

Functional Overview	5	Upstream USB Connection	20
System Initialization	5	Downstream USB Connections	20
Enumeration	5	LED Connections	20
Downstream Ports	5	System Block Diagram	21
Upstream Port	5	Absolute Maximum Ratings	22
Power Switching	5	Operating Conditions	22
Overcurrent Detection	6	Electrical Characteristics	22
Port Indicators	6	DC Electrical Characteristics	22
Pin Configuration	7	USB Transceiver	22
Pin Description	8	AC Electrical Characteristics	22
Default Descriptors	10	Ordering Information	23
Device Descriptor	10	Ordering Code Definitions	23
Configuration Descriptor	10	Package Diagram	24
Interface Descriptor	11	Acronyms	25
Endpoint Descriptor	11	Document Conventions	25
Device Qualifier Descriptor	11	Units of Measure	25
Hub Descriptor	12	Document History Page	26
Configuration Options	13	Sales, Solutions, and Legal Information	27
0xD0 Load	13	Worldwide Sales and Design Support	27
0xD2 Load	13	Products	27
0xD4 Load	14	PSoC® Solutions	27
Supported USB Requests	17	Cypress Developer Community	27
Device Class Commands	17	Technical Support	27
Hub Class Commands	18		



Functional Overview

The Cypress CY7C65621/31 USB 2.0 hubs are high performance, low system cost solutions for USB. The CY7C65621/31 USB 2.0 hubs integrate 1.5 k Ω upstream pull up resistors for full speed operation and all downstream 15 k Ω pull down resistors and series termination resistors on all upstream and downstream D+ and D– pins. This results in optimization of system costs by providing built-in support for the USB 2.0 specification.

System Initialization

On power up, the CY7C65621/31 reads an external SPI EEPROM for configuration information. At the most basic level, this EEPROM has the Vendor ID (VID), Product ID (PID), and Device ID (DID) for the customer's application. For more specialized applications, other configuration options can be specified. See [Configuration Options on page 13](#) for more details.

After reading the EEPROM, if VBUSPOWER (connected to up-stream V_{BUS}) is high, CY7C65621/31 enables the pull up resistor on D+ to indicate its presence to the upstream hub, after which a USB Bus Reset is expected. During this reset, CY7C65621/31 initiates a chirp to indicate that it is a high speed peripheral. In a USB 2.0 system, the upstream hub responds with a chirp sequence, and CY7C65621/31 is in a high speed mode, with the upstream D+ pull up resistor turned off. In USB 1.x systems, no such chirp sequence from the upstream hub is seen, and CY7C65621/31 operates as a normal 1.x hub (operating at full speed).

Enumeration

After a USB Bus Reset, CY7C65621/31 is in an unaddressed, unconfigured state (configuration value set to '0'). During the enumeration process, the host sets the hub's address and configuration.

When the hub is configured, the full hub functionality is available.

Downstream Ports

The CY7C65621/31 supports a maximum of four downstream ports, each of which may be marked as usable or removable in the extended configuration (0xD2 EEPROM load or 0xD4 EEPROM load, see [Configuration Options on page 13](#). Downstream D+ and D– pull down resistors are incorporated in CY7C65621/31 for each port. Before the hubs are configured, the ports are driven SE0 (Single Ended Zero, where both D+ and D– are driven low) and are set to the unpowered state. When the hub is configured, the ports are not driven, and the host may power the ports by sending a SetPortPower command for each port. After a port is powered, any connect or disconnect event is detected by the hub. Any change in the port state is reported by

the hubs back to the host through the Status Change Endpoint (endpoint 1). Upon receipt of SetPortReset request for a port with a device connected, the hub does as follows:

- Performs a USB reset on the corresponding port
- Puts the port in an enabled state
- Enables the green port indicator for that port (if not previously overridden by the host)
- Enables babble detection when the port is enabled.

Babble consists of a non idle condition on the port after EOF2. If babble is detected on an enabled port, that port is disabled. A ClearPortEnable request from the host also disables the specified port.

Downstream ports can be individually suspended by the host with the SetPortSuspend request. If the hub is not suspended, a remote wakeup event on that port is reflected to the host through a port change indication in the Hub Status Change Endpoint. If the hub is suspended, a remote wakeup event on this port is forwarded to the host. The host may resume the port by sending a ClearPortSuspend command.

Upstream Port

The upstream port includes the transmitter and the receiver state machine. The transmitter and receiver operate in high speed and full speed depending on the current hub configuration.

The transmitter state machine monitors the upstream facing port while the Hub Repeater has connectivity in the upstream direction. This machine prevents babble and disconnect events on the downstream facing ports of this hub from propagating and causing the hub to be disabled or disconnected by the hub to which it is attached.

Power Switching

The CY7C65621/31 includes interface signals for external port power switches. Both ganged and individual (per-port) configurations are supported, with individual switching being the default. Initially all ports are unpowered. After enumerating, the host may power each port by sending a SetPortPower request for that port. The power switching and over-current detection of downstream ports is managed by control pins connected to an external power

switch device. PWR [n]# output pins of the CY7C65621/31 series are connected to the respective external power switch's port power enable signals. Note that each port power output pin of the external power switch must be bypassed with an electrolytic or tantalum capacitor as required by the USB specification. These capacitors supply the inrush currents, which occur during downstream device hot-attach events. The polarity of this pin can be configured through the EEPROM; see [0xD4 Load on page 14](#).



Overcurrent Detection

Overcurrent detection includes 8 ms of timed filtering by default. This parameter is configured from the external EEPROM in a range of 0 ms to 15 ms for both enabled ports and disabled ports individually. Detection of overcurrent on downstream ports is managed by control pins connected to an external power switch device.

The OVR[n]# pins of the CY7C65621/31 series are connected to the respective external power switch's port overcurrent indication (output) signals. After detecting an overcurrent condition, hub reports overcurrent condition to the host and disables the PWR# output to the external power device. The polarity of the OVR pins can be configured through the EEPROM; see [0xD4 Load on page 14](#).

Port Indicators

The USB 2.0 port indicators are also supported directly by CY7C65621/31. According to the specification, each downstream port of the hub optionally supports a status indicator. The presence of indicators for downstream facing ports is specified by bit 7 of the wHubCharacteristics field of the hub class descriptor. The default CY7C65621/31 descriptor specifies that port indicators are supported (wHubCharacteristics, bit 7 is

set). If port indicators are not included in the hub, disable this bit through EEPROM settings.

Each port indicator pin is strategically located directly on the opposite edge of the port with which it is associated. A port indicator provides two colors: green and amber. This is usually implemented as two separate LEDs, one amber and the other green. A combination of hardware and software control is used to inform the user of the current status of the port or the device attached to the port and to guide the user through problem resolution. Colors and blinking provide information to the user. The significance of the color of the LED depends on the operational mode of CY7C65621/31. The CY7C65621/31 port indicators has two modes of operation: automatic and manual.

On power up the CY7C65621/31 defaults to automatic mode, where the color of the Port Indicator (green, amber, off) indicates the functional status of the CY7C65621/31 port. In automatic mode, the CY7C65621/31 turns on the green LED whenever the port is enabled and the amber LED when an overcurrent condition is detected. The color of the port indicator is set by the port state machine. Blinking of the LEDs is not supported in automatic mode. [Table 1](#) identifies the mapping of color to port state in automatic mode.

Table 1. Automatic Port State to Port Indicator Color Mapping ^[1]

Downstream Facing Hub Port State			
Powered Off	Disconnected, Disabled, Not Configured, Resetting, Testing	Enabled, Transmit, or TransmitR	Suspended, Resuming, SendEOR, Restart_E/S
Off or Amber, if due to an Overcurrent Condition	Off	Green	Off

The LED control lines can also be modulated with a square wave for power conservation. The polarity of these pins is programmable, see [0xD4 Load on page 14](#).

In manual mode, the indicators are under the control of the host, which can turn on the LEDs, or leave them off. This is done by a USB hub class request. Blinking of the LEDs is supported in manual mode. The port indicators allow the user to intervene in any error detection. For example, when babble is detected while plugging in a defective device, or when an overcurrent condition occurs, the port indicators corresponding to the downstream port blink green or only light the amber LED, respectively.

[Table 2](#) displays the color definition of the indicators when CY7C65621/31 is in manual mode.^[1]

Table 2. Port Indicator Color Definitions in Manual Mode ^[2]

Color Definition	Port State
Off	Not Operational
Amber	Error Condition
Green	Fully Operational
Blinking Off/Green	Software Attention
Blinking Off/Amber	Hardware Attention
Blinking Green/Amber	Reserved

Notes

- Information presented in [Table 1](#) is from USB 2.0 Specification Tables 11-6.
- Information presented in [Table 2](#) is from USB 2.0 Specification 11-7.

Pin Configuration

Figure 1. 56-pin Quad Flat Pack No Leads (8 mm × 8 mm) pinout ^[3]

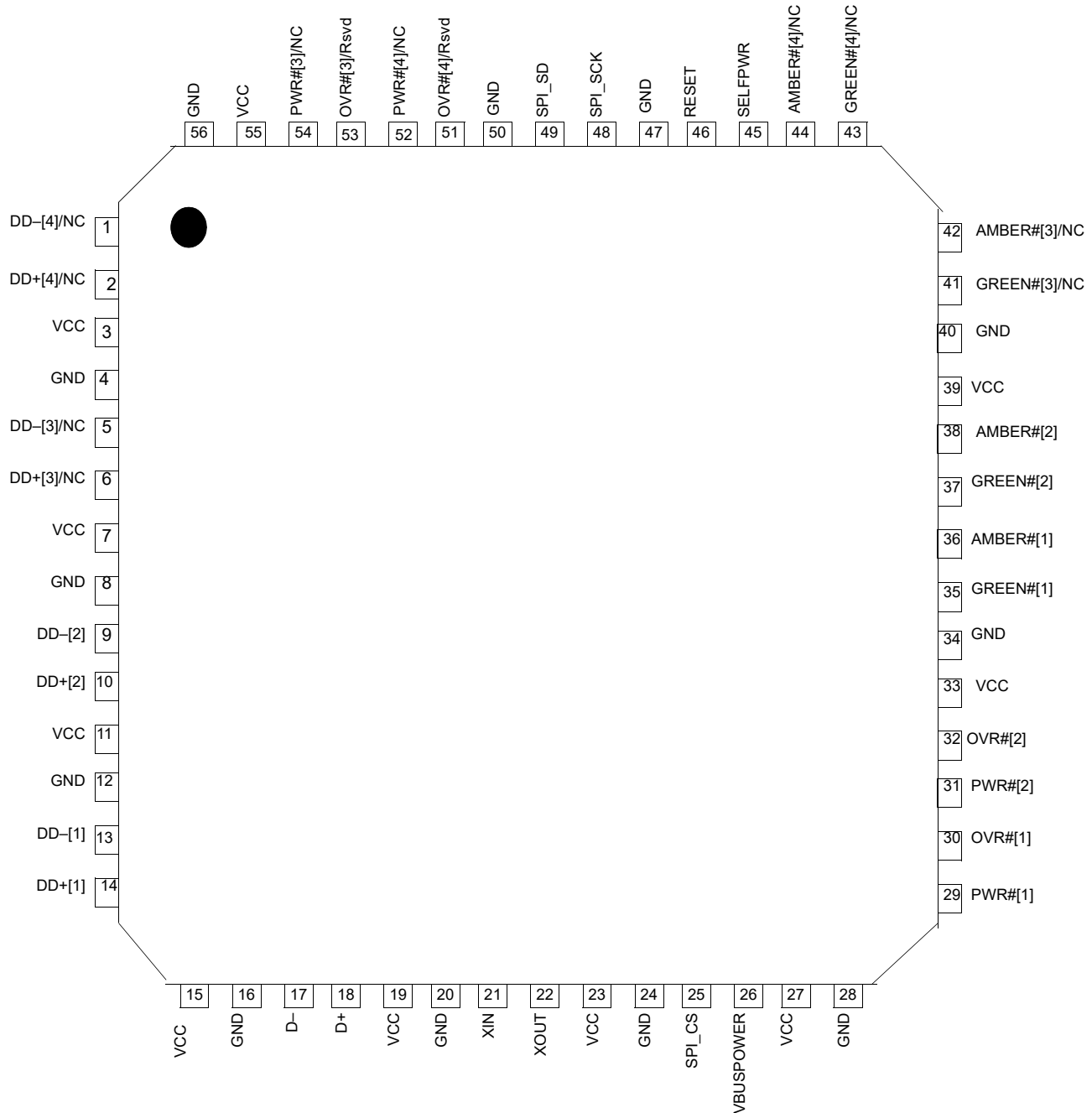

Note

3. NC and Rsvd are for CY7C65621 only.



Pin Description

Table 3. Pin Assignments ^[4]

Pin	CY7C65631 Name	CY7C65621 Name	Type	Default	Description
3	VCC	VCC	Power	N/A	V_{CC} . This signal provides power to the chip.
7	VCC	VCC	Power	N/A	V_{CC} . This signal provides power to the chip.
11	VCC	VCC	Power	N/A	V_{CC} . This signal provides power to the chip.
15	VCC	VCC	Power	N/A	V_{CC} . This signal provides power to the chip.
19	VCC	VCC	Power	N/A	V_{CC} . This signal provides power to the chip.
23	VCC	VCC	Power	N/A	V_{CC} . This signal provides power to the chip.
27	VCC	VCC	Power	N/A	V_{CC} . This signal provides power to the chip.
33	VCC	VCC	Power	N/A	V_{CC} . This signal provides power to the chip.
39	VCC	VCC	Power	N/A	V_{CC} . This signal provides power to the chip.
55	VCC	VCC	Power	N/A	V_{CC} . This signal provides power to the chip.
4	GND	GND	Power	N/A	GND . Connect to ground with as short a path as possible.
8	GND	GND	Power	N/A	GND . Connect to ground with as short a path as possible.
12	GND	GND	Power	N/A	GND . Connect to ground with as short a path as possible.
16	GND	GND	Power	N/A	GND . Connect to ground with as short a path as possible.
20	GND	GND	Power	N/A	GND . Connect to ground with as short a path as possible.
24	GND	GND	Power	N/A	GND . Connect to ground with as short a path as possible.
28	GND	GND	Power	N/A	GND . Connect to ground with as short a path as possible.
34	GND	GND	Power	N/A	GND . Connect to ground with as short a path as possible.
40	GND	GND	Power	N/A	GND . Connect to ground with as short a path as possible.
47	GND	GND	Power	N/A	GND . Connect to ground with as short a path as possible.
50	GND	GND	Power	N/A	GND . Connect to ground with as short a path as possible.
56	GND	GND	Power	N/A	GND . Connect to ground with as short a path as possible.
21	XIN	XIN	Input	N/A	24 MHz Crystal IN or external Clock Input.
22	XOUT	XOUT	Output	N/A	24 MHz Crystal OUT. (NC if external clock is used)
46	RESET#	RESET#	Input	N/A	Active LOW Reset. This pin resets the entire chip. It is normally tied to V _{CC} through a 100K resistor, and to GND through a 0.1 μF capacitor. Other than this, no other special power up procedure is required.
45	SELPWR	SELPWR	Input	N/A	Self Power. Indicator for bus or self powered. 0 is bus powered, 1 is self powered.
26	VBUSPOWER	VBUSPOWER	Input	N/A	VBUS. Connect to the VBUS pin of the upstream connector. This signal indicates to the hub that it is in a connected state, and may enable the D+ pull up resistor to indicate a connection. (The hub does so after the external EEPROM is read).
SPI Interface					
25	SPI_CS	SPI_CS	Output	O	SPI Chip Select. Connect to CS pin of the EEPROM.
48	SPI_SCK	SPI_SCK	Output	O	SPI Clock. Connect to EEPROM SCK pin.
49	SPI_SD	SPI_SD	I/O/Z	Z	SPI Dataline Connect to GND with 15 kΩ resistor and to the Data I/O pin of the EEPROM.
Upstream Port					
17	D-	D-	I/O/Z	Z	Upstream D- Signal.
18	D+	D+	I/O/Z	Z	Upstream D+ Signal.

Note

4. Unused port DD+/DD- lines can be left floating. Leave the port power, amber, and green LED pins unconnected, and deassert the overcurrent pin. Do not leave the overcurrent pin floating; it is an input.

Table 3. Pin Assignments ^[4]<continue> (continued)

Pin	CY7C65631 Name	CY7C65621 Name	Type	Default	Description
Downstream Port 1					
13	DD-[1]	DD-[1]	I/O/Z	Z	Downstream D- Signal.
14	DD+[1]	DD+[1]	I/O/Z	Z	Downstream D+ Signal.
36	AMBER#[1]	AMBER#[1]	Output	1	LED. Driver output for amber LED. Port indicator support. Default is active LOW. Polarity is controlled through EEPROM.
35	GREEN#[1]	GREEN#[1]	Output	1	LED. Driver output for green LED. Port indicator Support. Default is Active LOW. Polarity is controlled through EEPROM.
30	OVR#[1]	OVR#[1]	Input	1	Overcurrent Condition Detection Input. Default is active LOW. Polarity is controlled through EEPROM.
29	PWR#[1]	PWR#[1]	O/Z	Z	Power Switch Driver Output. Default is active LOW. Polarity is controlled through EEPROM.
Downstream Port 2					
9	DD-[2]	DD-[2]	I/O/Z	Z	Downstream D- Signal.
10	DD+[2]	DD+[2]	I/O/Z	Z	Downstream D+ Signal.
38	AMBER#[2]	AMBER#[2]	Output	1	LED. Driver output for amber LED. Port indicator support. Default is active LOW. Polarity is controlled through EEPROM.
37	GREEN#[2]	GREEN#[2]	Output	1	LED. Driver output for green LED. Port indicator support. Default is active LOW. Polarity is controlled through EEPROM.
32	OVR#[2]	OVR#[2]	Input	1	Overcurrent Condition Detection Input. Default is active LOW. Polarity is controlled through EEPROM.
31	PWR#[2]	PWR#[2]	O/Z	Z	Power Switch Driver Output. Default is active LOW. Polarity is controlled through EEPROM.
Downstream Port 3					
5	DD-[3]	NC	I/O/Z	Z	Downstream D- Signal.
6	DD+[3]	NC	I/O/Z	Z	Downstream D+ Signal.
42	AMBER#[3]	NC	Output	1	LED. Driver output for amber LED. Port indicator support. Default is active LOW. Polarity is controlled through EEPROM.
41	GREEN#[3]	NC	Output	1	LED. Driver output for green LED. Port indicator support. Default is active LOW. Polarity is controlled through EEPROM.
53	OVR#[3]	Reserved	Input	1	Overcurrent Condition Detection Input. Default is Active LOW. Polarity is controlled through EEPROM. Reserved. Pull to deasserted state with external resistor on the CY7C65621/31.
54	PWR#[3]	NC	O/Z	Z	Power Switch Driver Output. Default is active LOW. Polarity is controlled through EEPROM.
Downstream Port 4					
1	DD-[4]	NC	I/O/Z	Z	Downstream D- Signal.
2	DD+[4]	NC	I/O/Z	Z	Downstream D+ Signal.
44	AMBER#[4]	NC	Output	1	LED. Driver output for amber LED. Port indicator support. Default is active LOW. Polarity is controlled through EEPROM.
43	GREEN#[4]	NC	Output	1	LED. Driver output for green LED. Port indicator support. Default is active LOW. Polarity is controlled through EEPROM.
51	OVR#[4]	Reserved	Input	1	Overcurrent Condition Detection Input. Default is Active LOW. Polarity is controlled through EEPROM. Reserved. Pull to deasserted state with external resistor on the CY7C65621/31
52	PWR#[4]	NC	O/Z	Z	Power Switch Driver Output. Default is active LOW. Polarity is controlled through EEPROM.



Default Descriptors

This section presents the different descriptors that are available. There is a table for each that lists the functionality of each descriptor.

Device Descriptor

The standard device descriptor for CY7C65621/31 is based on the information found in the SPI EEPROM. The information in the EEPROM overrides the default descriptor values. If no EEPROM is used, the CY7C65621/31 enumerates with the default descriptor values as shown in the table. If a blank EEPROM is connected, the hub enumerates as vendor defined class instead of a hub class. This is for the purpose of programming the EEPROM with the Cypress driver.

Byte	Full Speed	High Speed	Field Name	Description
0	0x12	0x12	bLength	18 Bytes
1	0x01	0x01	bDescriptorType	Device_Descriptor
2,3	0x0110	0x0200	bcdUSB	USB Specification 2.0 (1.1 if forced FS)
4	0x09	0x09	bDeviceClass	Hub
5	0x00	0x00	bDeviceSubClass	None
6	0x00	0x01	bDeviceProtocol	None
7	0x40	0x40	bMaxPacketSize0	64 Bytes
8,9	0x04B4	0x04B4	wIdVendor	VID (overridden by what is defined in EEPROM)
10,11	0x6560	0x6560	wIdProduct	PID (overridden by what is defined in EEPROM)
12, 13	0x0915	0x0915	wbcdDevice	DID (overridden by what is defined in EEPROM)
14	0x00	0x00	iManufacturer	Overridden by EEPROM
15	0x00	0x00	iProduct	Overridden by EEPROM
16	0x00	0x00	iSerialNumber	Overridden by EEPROM
17	0x01	0x01	bNumConfigurations	One Configuration Supported

Configuration Descriptor

Byte	Full Speed	High Speed	Field Name	Description
0	0x09	0x09	bLength	9 bytes
1	0x02 ^[5] /0x07 ^[6]	0x02 ^[5] /0x07 ^[6]	bDescriptorType	Config_Descriptor
2	0x0019	0x0019	wTotalLength	Length of all other descriptors
4	0x01	0x01	bNumInterfaces	1
5	0x01	0x01	bConfigurationValue	The configuration to use
6	0x00	0x00	iConfiguration	
7	0xA0 0xE0	0xA0 0xE0	bmAttributes	Value depends on pin 45 - SELFPWR signal SELPWR = 0 yields 0xA0 and =1 yields 0xE0
8	0x28	0x57 ^[5]	bMaxPower	

Notes

5. Configured speed descriptor.
6. Other speed descriptor.



Interface Descriptor

Byte	Full Speed	High Speed	Field Name	Description
0	0x09	0x09	bLength	9 bytes
1	0x04	0x04	bDescriptorType	Interface_Descriptor
2	0x00	0x00	bInterfaceNumber	
3	0x00	0x00	bAlternateSetting	
4	0x01	0x01	bNumEndpoints	
5	0x09	0x09	bInterfaceClass	
6	0x00	0x00	bInterfaceSubClass	
7	0x00	0x00	bInterfaceProtocol	
8	0x00	0x00	iInterface	

Endpoint Descriptor

Byte	Full Speed	High Speed	Field Name	Description
0	0x07	0x07	bLength	7 Bytes
1	0x05	0x05	bDescriptorType	Endpoint_Descriptor
2	0x81	0x81	bEndpointAddress	IN endpoint #1
3	0x03	0x03	bmAttributes	Interrupt
4,5	0x0001	0x0001	wMaxPacketSize	Maximum packet size
6	0xFF	0x0C	bInterval	Polling rate

Device Qualifier Descriptor

Byte	Full Speed	High Speed	Field Name	Description
0	0x0A	0x0A	bLength	10 Bytes
1	0x06	0x06	bDescriptorType	Device_Qualifier
2,3	0x0200	0x0200	bcdUSB	
4	0x09	0x09	bDeviceClass	
5	0x00	0x00	bDeviceSubClass	
6	0x01	0x00	bDeviceProtocol	
7	0x40	0x40	bMaxPacketSize0	
8	0x01	0x01	bNumConfigurations	
9	0x00	0x00	bReserved	



Hub Descriptor

Byte	All Speed	Field Name	Description
0	0x09	bLength	9 bytes
1	0x29	bDescriptorType	Hub descriptor
2	0x04 ^[7] 0x02	bNbrPorts	Number of ports supported, CY7C65631. Number of ports supported, CY7C65621.
3, 4	0x0089 ^[7]	wHubCharacteristics	<p>b1, b0: Logical power switching mode 00: Ganged power switching (all ports' power at once) 01: Individual port power switching (Default in CY7C65621/31)</p> <p>b2: Identifies a compound device, 0: Hub is not part of a compound device (Default in CY7C65621/31), 1: Hub is part of a compound device.</p> <p>b4, b3: Overcurrent protection mode 00: Global overcurrent protection. The hub reports overcurrent as a summation of all ports' current draw, without a breakdown of individual port overcurrent status. 01: Individual port overcurrent protection. The hub reports overcurrent on a per-port basis. Each port has an over-current status (Default in CY7C65621/31). 1X: No overcurrent protection. This option is allowed only for bus powered hubs that do not implement overcurrent protection.</p> <p>b6, b5: TT Think Time 00: TT requires at most eight FS bit times of inter transaction gap on a full or low speed downstream bus (Default in CY7C65621/31).</p> <p>b7: Port indicators supported, 0: Port indicators are not supported on its downstream facing ports and the SetPortIndicator request has no effect. 1: Port indicators are supported on its downstream facing ports and the SetPortIndicator request controls the indicators. See Functional Overview and Supported USB Requests. (Default in CY7C65621/31).</p> <p>b15, b8: Reserved</p>
5	0x32 ^[7]	bPwrOn2PwrGood	Time from when the port is powered to when the power is good on that port
6	0x28 ^[7] 0xAE ^[7]	bHubContrCurrent	Maximum current requirement for the Hub Controller at full speed. Maximum current requirement for the Hub Controller at high speed.
7	0x00 ^[7]	bDeviceRemovable	Indicates if the logical port has a removable device attached (0 = removable, 1 = non-removable)
8	0xFF ^[7]	bPortPwrCtrlMask	Required for compatibility with software written for 1.0 compliant devices

Note

7. This value is configured through the external EEPROM.



Configuration Options

Systems using CY7C65621/31 may have the option of using a fuse ROM which is preset at the factory to configure the hub. Otherwise, it must have an external EEPROM for the device to have a unique VID, PID, and DID. The CY7C65621/31 can communicate with SPI EEPROM that are either double byte addressed or single byte with the 9th bit within the instruction byte, such as the 24LC040 parts use. The 25LC080 EEPROM uses the double byte address format, and therefore the CY7C656xx can communicate with these parts. The '010s and '020s use the same command format as is used to interface with the '040. Therefore, these can also be used to interface with the CY7C65621/31.

If the attached EEPROM is blank (0xFF), the hub enumerates as a vendor class device. In this configuration, the hub connects to the Cypress driver to allow programming of the EEPROM. When the EEPROM is programmed a power cycle configures the chip as a hub class device.

0xD0 Load

With this EEPROM format, only a unique VID, PID, and DID must be present in the external SPI EEPROM. The contents of the EEPROM must contain this information in the following format:

Byte	Value
0	0xD0
1	VID (LSB)
2	VID (MSB)
3	PID (LSB)
4	PID (MSB)
5	reserved
6	DID (MSB)

0xD2 Load

Byte	Value (MSB->LSB)
0	0xD2
1	VID (LSB)
2	VID (MSB)
3	PID (LSB)
4	PID (MSB)
5	reserved
6	DID (MSB)
7	EnabledOverCurrentTimer[3:0], DisabledOvercurrentTimer[3:0]
8	ActivePorts[3:0], RemovablePorts[3:0]
9	MaxPower
10	HubControllerPower
11	PowerOnTimer
12	IllegalHubDescriptor, CompoundDevice, FullspeedOnly, NoPortIndicators, Reserved, GangPowered, Reserved, Reserved

Byte 0: 0xD2

Needs to be programmed with 0xD2

Byte 1: VID (LSB)

Least Significant Byte of Vendor ID

Byte 2: VID (MSB)

Most Significant Byte of Vendor ID

Byte 3: PID (LSB)

Least Significant Byte of Product ID

Byte 4: PID (MSB)]

Most Significant Byte of Product ID

Byte 5: Reserved

Reserved

Byte 6: DID (MSB)]

Most Significant Byte of Device ID

Byte 7: EnabledOvercurrentTimer[3:0], DisabledOvercurrentTimer[3:0]

Count time in ms for filtering overcurrent detection. Bits 7–4 are for an enabled port, and bits 3–0 are for a disabled port. Both range from 0 ms to 15 ms. See section [Port Indicators on page 6](#). Default: 8 ms = 0x88.

Byte 8: ActivePorts[3:0], RemovablePorts[3:0]

Bits 7–4 are the ActivePorts[3:0] bits that indicates if the corresponding port is usable. For example, a two-port hub that uses ports 1 and 4 sets this field to 0x09. The total number of ports reported in the Hub Descriptor: bNbrPorts field is calculated from this. Bits 3–0 are the RemovablePorts[3:0] bits that indicates whether the corresponding logical port is removable (set to high). Logical port numbers are from 1 to n where n is the total number of active ports. If port 2 is disabled then physical ports 1, 3, and 4 map to logical ports 1, 2, and 3. These bit values are reported appropriately in the HubDescriptor:DeviceRemovable field. Default: 0xFF.

Byte 9: MaximumPower

This value is reported in the ConfigurationDescriptor:bMaxPower field and is the current in 2 mA increments that is required from the upstream hub. Default: 0x28 = 80 mA for full speed and 0x57 = 174 mA for high speed.

Byte 10: HubControllerPower

This value is reported in the HubDescriptor:bHubContrCurrent field and is the current in milliamperes required by the hub controller. Default: 0x50 = 80 mA for full speed and 0xAE = 174 mA for high speed.

Byte 11: PowerOnTimer

This value is reported in the HubDescriptor: bPwrOn2PwrGood field and is the time in 2 ms intervals from the SetPortPower command until the power on the corresponding downstream port is good. Default: 0x32 = 100 ms.



Byte 12: IllegalHubDescriptor, CompoundDevice, Full speedOnly, NoPortIndicators, Reserved, GangPowered, SingleTTOOnly

Bit 7: IllegalHubDescriptor. For GetHubDescriptor request, some USB hosts use a DescriptorType of 0x00 instead of HUB_DESCRIPTOR, 0x29. According to the USB 2.0 standard, a hub must treat this as a Request Error, and STALL the transaction accordingly (USB 2.0, 11.24.2.5). For systems that do not accept this, the IllegalHubDescriptor configuration bit may be set to allow CY7C65621/31 to accept a DescriptorType of 0x00 for this command. Default is 1.

Bit 6: CompoundDevice. Indicates whether the hub is part of a compound device. This is reported in the HubDescriptor, wHub-Characteristics: b2. Default set to '0'.

Bit 5: Fullspeed. Only configures the hub to be a full speed only device. Default is set to '0'.

Bit 4: NoPortIndicators. Turns off the port indicators and does not report them as present in the HubDescriptor, wHubCharacteristics b7 field. Default is set to '0'.

Bit 3: Reserved. Set this bit to '0'.

Bit 2: GangPowered. Indicates whether the port power switching is ganged (set to 1) or per-port (set to '0'). This is reported in the HubDescriptor, wHubCharacteristics field, b4, b3, b1, and b0. Default is set to '0'.

Bit 1: Reserved. Default is set to '0'.

Bit 0: Reserved. Default is set to '0'.

0xD4 Load

Byte	Value (MSB->LSB)	Factory Fusible
0	0xD4	
1	VID (LSB)	X
2	VID (MSB)	X
3	PID (LSB)	X
4	PID (MSB)	X
5	reserved	
6	DID (MSB)	X
7	EnabledOverCurrentTimer[3:0], DisableOvercurrentTimer[3:0]	
8	MaxPower (Full speed)	X
9	MaxPower (High speed)	X
10	Reserved	
11	Reserved	
12	HubControllerPower Full Speed Bus Powered	X
13	HubControllerPower High Speed Bus Powered	X
14	HubControllerPower Full Speed Self Powered	

Byte	Value (MSB->LSB)	Factory Fusible
15	HubControllerPower High Speed Self Powered	
16	PowerOnTimer	
17	IllegalHubDescriptor, CompoundDevice, FullspeedOnly, NoPortIndicators, Reserved, GangPowered, SingleTTOOnly, Reserved	X
18	AmberPolarity, GreenPolarity, ModulateIndicators, PowerControlPolarity, OverCurrentPolarity, OverCurrentMode1, OverCurrentMode2	X
19	Write Protect	
20	NumLangs	
21	SupportedStrings	
22	ActivePorts[3:0]	
23	RemovablePorts[3:0]	X
24	LangID	
a = 24 + 2N	iManufacturer	
b = a + 2N	iProduct	
c = b + 2N	iSerialNumber	
d = c + 2N	iConfiguration(FS)	
e = d + 2N	iConfiguration(HS)	
f = e + 2N	iInterface(0)	
g = f + 2N	reserved	
h = g + 2N	Strings	

N: NumLangs

Byte 0: 0xD4

Needs to be programmed with 0xD4

Byte 1: VID (LSB)

Least Significant Byte of Vendor ID

Byte 2: VID (MSB)

Most Significant Byte of Vendor ID

Byte 3: PID (LSB)

Least Significant Byte of Product ID

Byte 4: PID (MSB)

Most Significant Byte of Product ID

Byte 5: Reserved

Reserved.

Byte 6: DID (MSB)

Most Significant Byte of Device ID



Byte 7: EnabledOvercurrentTimer[3:0], DisabledOvercurrentTimer[3:0]

Count time in ms for filtering overcurrent detection. Bits 7–4 are for an enabled port, and bits 3–0 are for a disabled port. Both range from 0 ms to 15 ms. See section [Port Indicators on page 6](#). Default: 8 ms = 0x88.

Byte 8: MaximumPower (Full Speed)

This value is reported in the ConfigurationDescriptor:bMaxPower field and is the current in 2 mA increments that is required from the upstream hub when connected at full speed. Default: 0x28 = 80 mA for full speed.

Byte 9: MaximumPower (High Speed)

This value is reported in the ConfigurationDescriptor:bMaxPower field and is the current in 2 mA increments that is required from the upstream hub when connected at high speed. Default: 0x57 = 174 mA for high speed.

Byte 10: Reserved

Write zeros to this location.

Byte 11: Reserved

Write zeros to this location.

Byte 12: HubControllerPower (Full Speed, bus powered)

This value is reported in the HubDescriptor:bHubContrCurrent field and is the current in milliamperes required by the hub controller when connected on the upstream hub as a full speed. Default: 0x50 = 80 mA for full speed.

Byte 13: HubControllerPower (High Speed, bus powered)

This value is reported in the HubDescriptor:bHubContrCurrent field and is the current in milliamperes required by the hub controller when connected on the upstream hub as a high speed. Default: 0xAE = 174 mA for high speed.

Byte 14: HubControllerPower (Full Speed, self powered)

This value is reported in the HubDescriptor:bHubContrCurrent field and is the current in milliamperes required by the hub controller when connected on the upstream hub as a full speed. Default: 0x50 = 80 mA for full speed.

Byte 15: HubControllerPower (High speed, self powered)

This value is reported in the HubDescriptor:bHubContrCurrent field and is the current in milliamperes required by the hub controller when connected on the upstream hub as a high speed. Default: 0x64 = 100 mA for high speed.

Byte 16: PowerOnTimer

This value is reported in the HubDescriptor:bPwrOn2PwrGood field and is the time in 2 ms increments from the SetPortPower command until the power on the corresponding downstream port is good. Default: 0x32 = 100 ms.

Byte 17: IllegalHubDescriptor, CompoundDevice, Full speedOnly, NoPortIndicators, Reserved, GangPowered, Reserved

Bit 7: IllegalHubDescriptor. For GetHubDescriptor request, some USB hosts use a DescriptorTypeof 0x00 instead of HUB_DESCRIPTOR, 0x29. According to the USB 2.0 standard, a hub must treat this as a Request Error, and STALL the transaction accordingly (USB 2.0, 11.24.2.5). For systems that do not accept this, the IllegalHubDescriptor configuration bit may be set to allow CY7C65621/31 to accept a DescriptorType of 0x00 for this command. Default set to 1.

Bit 6: CompoundDevice. Indicates whether the hub is part of a compound device. This is reported in the HubDescriptor, wHub-Characteristics: b2. Default is set to '0'.

Bit 5: Fullspeed. Only configures the hub to be a full speed only device. Default is set to '0'.

Bit 4: NoPortIndicators. Turns off the port indicators and does not report them as present in the HubDescriptor, wHubCharacteristics b7 field. Default is set to '0'.

Bit 3: Reserved. Set this bit to '0'.

Bit 2: GangPowered. Indicates whether the port power switching is ganged (set to 1) or per-port (set to '0'). This is reported in the HubDescriptor, wHubCharacteristics field, b4, b3, b1, and b0. Default is set to '0'.

Bit 1: Reserved. Default is set to '0'.

Bit 0: Reserved. Default is set to '0'.

Byte 18: AmberPolarity, GreenPolarity, SelfPowerable, ModulateIndicators, PowerControlPolarity, OverCurrentPolarity, OverCurrentMode1, OverCurrentMode2

Bit 7: AmberPolarity. Indicates the polarity of the amber indicator control. (1 = high, 0 = low)

Bit 6: GreenPolarity. Indicates the polarity of the green indicator control. (1 = high, 0 = low)

Bit 5: SelfPowerable. Indicates whether the hub is capable of operating in self-powered mode. If '0', the hub is capable of bus-powered operation only.

Bit 4: ModulateIndicators. If this bit is set, the indicator outputs are modulated by a square wave of 120 Hz, for power savings. If '0', the outputs are static.

Bit 3: PowerControlPolarity. If set, the power control outputs are active HIGH. If not set, the power control outputs are active LOW.

Bit 2: OverCurrentPolarity. If set, the over-current inputs are active HIGH. If not set, the over-current inputs are active LOW.

Bit 1: OverCurrentMode1. Reported as bit 4 of the wHubCharacteristics field of the hub descriptor. If set to '1', this bit disables over-current detection.

Bit 0: OverCurrentMode2. Reported as bit 3 of the wHubCharacteristics field of the hub descriptor. If Bit 1 of this byte is set to '0', over-current detection is enabled. If this bit (Bit 0) is set to '1', the hub reports over-current on a per-port basis. If set to '0', the hub reports over-current as the summation of all ports' current draw.

**Byte 19: Write Protect**

Writing the value 0x42 to this field enables Write Protect and any future writes to the EEPROM will fail. Default is set to '0'.

Byte 20: NumLangs

Number of supported string languages. CY7C656xx supports a maximum of 31 languages; if this field is set to '0' or a number larger than 31, all string support is disabled.

Byte 21: SupportedStrings

This field contains a bitmap of strings supported by the hub. A set bit indicates that the standard string is supported. A bit not set indicates that the string is not supported. The hub controller returns a non-zero index for each string that is supported, and returns 0x00 for each string not supported, as indicated by this field. The bits in this field correspond to the following standard strings.

Table 4. Byte 21 Supported Strings

Bit	Name	Description
7	Reserved	
6	Reserved	
5	Interface (0)	The iInterface string index reported in the first interface descriptor (alternate setting 0)
4	iConfiguration	(High speed) The iConfiguration string index reported in the configuration descriptor, when operating at high speed
3	iConfiguration	(Full speed) The iConfiguration string index reported in the configuration descriptor, when operating at full speed
2	iSerial Number	The iSerialNumber string index reported in the device descriptor
1	iProduct	The iProduct string index reported in the device descriptor
0	iManufacturer	The iManufacturer string index reported in the device descriptor

Byte 22: ActivePorts[3:0]

Bits 3–0 are the ActivePorts[3:0] bits that indicates if the corresponding port is usable. For example, a two-port hub that uses ports 1 and 4 would set this field to 0x09. The total number of ports reported in the Hub Descriptor: bNbrPorts field is calculated from this. Default 0x0F

Byte 23: RemovablePorts[3:0]

Bits 3–0 are the RemovablePorts[3:0] bits that indicates whether the corresponding logical port is removable (set to high). Logical port numbers are from 1 to n where n is the total

number of active ports. If port 2 is disabled then physical ports 1, 3, and 4 map to logical ports 1, 2, and 3. These bit values are recorded in the HubDescriptor:DeviceRemovable field. Default 0x0F.

Byte 24: LangID

Array of LangID codes supported by the hub. Each LangID consists of two bytes, stored LSB first. The array has NumLangs entries (2 × NumLangs bytes).

Byte a: iManufacturer

Array of addresses for the iManufacturer strings. Each address is two bytes long, stored LSB first. The array has NumLangs entries (2 × NumLangs bytes). (The starting EEPROM address is based upon the number entered for NumLangs. The address $a = 24 + (2 \times \text{NumLangs})$).

Byte b: iProduct

Array of addresses for the iProduct strings. Each address is two bytes long, stored LSB first. The array has NumLangs entries (2 × NumLangs bytes). The address $b = a + (2 \times \text{NumLangs})$.

Byte c: iSerialNumber

Array of addresses for the iSerialNumber strings. Each address is two bytes long, stored LSB first. The array has NumLangs entries (2 × NumLangs bytes). The address $c = b + (2 \times \text{NumLangs})$.

Byte d: iConfiguration(Full Speed)

Array of addresses for the iConfiguration (full speed) strings. Each address is two bytes long, stored LSB first. The array has NumLangs entries (2 × NumLangs bytes). The address $d = c + (2 \times \text{NumLangs})$.

Byte e: iConfiguration(High Speed)

Array of addresses for the iConfiguration (high speed) strings. Each address is two bytes long, stored LSB first. The array has NumLangs entries (2 × NumLangs bytes). The address $e = d + (2 \times \text{NumLangs})$.

Byte f: iInterface(0)

Array of addresses for the iInterface(0) strings. Each address is two bytes long, stored LSB first. The array has NumLangs entries (2 × NumLangs bytes). The address $f = e + (2 \times \text{NumLangs})$.

Byte g: iInterface(1)

Reserved

Byte h: Strings

Strings addressed by the string pointers. Strings must comply with the USB specification. The first byte must be the length of the string in bytes, the second must be 0x03, and the string must be in Unicode.



Supported USB Requests

Device Class Commands

Table 5. Device Class Requests

Request	bmRequestType	bRequest	wValue	wIndex	wLength	Data
GetDeviceStatus	1000000B	0x00	0x0000	0x0000	0x0002	2 Byte Device Status
GetInterfaceStatus	1000001B	0x00	0x0000	0x0000	0x0002	2 Byte Interface Status
GetEndpointStatus	1000010B	0x00	0x0000	0x0000	0x0002	2 Byte Endpoint Status
GetDeviceDescriptor	1000000B	0x06	0x0001	Zero or Language ID	Descriptor Length	Descriptor
GetConfigDescriptor	1000000B	0x06	0x0002	Zero or Language ID	Descriptor Length	Descriptor
GetDeviceQualifierDescriptor	1000000B	0x06	0x0006	Zero or Language ID	Descriptor Length	Descriptor
GetOtherSpeedConfigurationDescriptor	1000000B	0x06	0x0007	Zero or Language ID	Descriptor Length	Descriptor
GetConfiguration ^[8]	1000000B	0x08	0x0000	0x0000	0x0001	Configuration Value
SetConfiguration ^[8]	0000000B	0x09	Configuration Value	0x0000	0x0000	None
GetInterface	1000001B	0xA	0x0000	0x0000	0x0001	Interface Number
SetInterface	0000001B	0x0B	Alternate Setting	Interface Number	0x0000	None
SetAddress	0000000B	0x05	Device Address	0x0000	0x0000	None
SetDeviceRemoteWakeup	0000000B	0x03	0x01	0x0000	0x0000	None
SetDeviceTest_J	0000000B	0x03	0x02	0x0100	0x0000	None
SetDeviceTest_K	0000000B	0x03	0x02	0x0200	0x0000	None
SetDeviceTest_SE0_NAK	0000000B	0x03	0x02	0x0300	0x0000	None
SetDeviceTest_Packet	0000000B	0x03	0x02	0x0400	0x0000	None
SetEndpointHalt	0000000B	0x03	0x00	0x0000	0x0000	None
ClearDeviceRemoteWakeup	0000000B	0x01	0x01	0x0000	0x0000	None
ClearEndpointHalt	0000000B	0x01	0x00	0x0000	0x0000	None

Note

8. Only one configuration is supported in CY7C656xx.



Hub Class Commands

Table 6. Hub Class Requests

Request	bmRequestType	bRequest	wValue	wIndex	wLength	Data
GetHubStatus	1010000B	0x00	0x0000	0x0000	0x0004	Hub status (See Table 11-19 of USB 2.0 Specifications) Change Status (See Table 11-20 of USB 2.0 Specifications)
GetPortStatus	10100011B	0x00	0x0000	Byte 0: 0x00 Byte 1: Port	0x0004	Port status (See Table 11-21 of USB 2.0 Specifications) Change Status (See Table 11-20 of USB 2.0 Specifications)
ClearHubFeature	0010000B	0x01	Feature Selectors ^[9] 0 or 1	0x0000	0x0000	None
ClearPortFeature	00100011B	0x01	Feature Selectors ^[9] 1, 2, 8, 16, 17, 18, 19, or 20	Byte 0: 0x00 Byte 1: Port	0x0000	None
ClearPortFeature	00100011B	0x01	Feature Selectors ^[9] 22 (PORT_INDICATOR)	Byte 0: - Byte 1: Port	0x0000	None
SetHubFeature	0010000B	0x03	Feature Selector ^[9] 0 or 1	0x0000	0x0000	
SetPortFeature	00100011B	0x03	Feature Selectors ^[9] 2, 4 or 8	Port	0x0000	None
SetPortFeature	00100011B	0x03	Feature Selector ^[9] 21 (PORT_TEST)	Byte 0: Selectors ^[9] 1, 2, 3, 4 or 5 Byte 1: Port	0x0000	None
SetPortFeature	00100011B	0x03	Feature Selector ^[9] 22 (PORT_INDICATOR)	Byte 0: Selectors ^[10] 0, 1, 2, or 3 Byte 1: Port	0x0000	None
GetHubDescriptor	1010000B	0x06	Descriptor Type and Descriptor Index		Hub Descriptor Length	
ClearTTBuffer	00100011B	0x08	Dev_Addr, EP_Num	TT_Port	0x0000	None
ResetTT	0010000B	0x09	0x0000	Byte 0: 0x00 Byte 1: Port	0x0000	None
GetTTState	10100011B	0X0A	TT_Flags	Byte 0: 0x00 Byte 1: Port	TT State Length	TT State
StopTT	00100011B	0x0B	0x0000	Byte 0: 0x00 Byte 1: Port	0x0000	None

Notes

9. Feature selector values for different features are presented in [Table 7 on page 19](#).

10. Selector values for different features are presented in [Table 9 on page 20](#).



Table 6. Hub Class Requests<continue> (continued)

Request	bmRequestType	bRequest	wValue	wIndex	wLength	Data
Vendor Commands						
Read EEPROM	11000000B	0x02	0x00	0x00	Length	Data
This request results in length bytes of data being read from the external memory device, and returned to the host. Data is read beginning with address 0. This request fails if there is no external memory device present. This request is only valid if the hub is in the Configured state; the request fails otherwise.						
Write EEPROM	01000000B	0x01	0x00	0x00	Length	Data
This request results in length bytes of data being written to the external memory device. Data is written beginning with address 0. This request fails if there is no external memory device present. This request is only valid if the hub is in the Configured state or if the external memory device write protect byte is set; the request fails otherwise.						

Table 7. Hub Class Feature Selector

Feature Selector	Recipient	Value
C_HUB_LOCAL_POWER	Hub	0
C_HUB_OVER_CURRENT	Hub	1
PORT_CONNECTION	Port	0
PORT_ENABLE	Port	1
PORT_SUSPEND	Port	2
PORT_RESET	Port	4
PORT_POWER	Port	8
PORT_LOW_SPEED	Port	9
C_PORT_CONNECTION	Port	16
C_PORT_ENABLE	Port	17
C_PORT_SUSPEND	Port	18
C_PORT_OVER_CURRENT	Port	19
C_PORT_RESET	Port	20
PORT_TEST	Port	21
PORT_INDICATOR	Port	22

Table 8. Test Mode Selector for Feature Selector PORT_TEST (0x21)^[11]

PORT_TEST Mode Description	Selector Value
Test_J	1
Test_K	2
Test_SE0_NAK	3
Test_Packet	4
Test_Force_Enable	5

Note

¹¹. Selector values for different features are presented in Table 8 on page 19.

Table 9. Port Indicator Selector for Feature Selector PORT_INDICATOR (0x22)

Port Indicator Color	Selector Value	Port Indicator Mode
Color set automatically as shown in Table 1 on page 6	0	Automatic mode
Amber	1	Manual mode
Green	2	Manual mode
Off	3	Manual mode

Upstream USB Connection

The following is a schematic of the USB upstream connector.

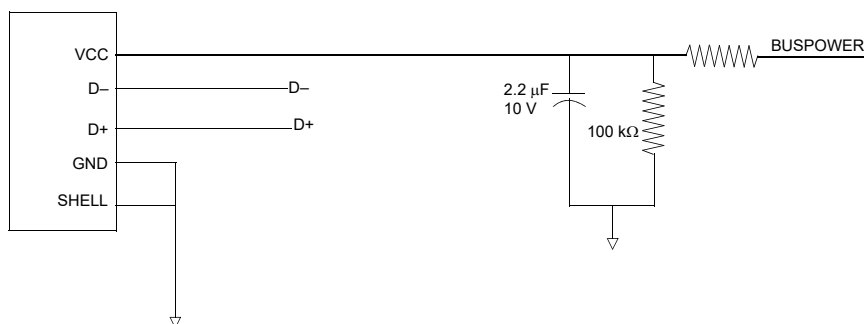
Figure 2. USB Upstream Port Connection

Downstream USB Connections

The following is a schematic of the USB downstream connector.

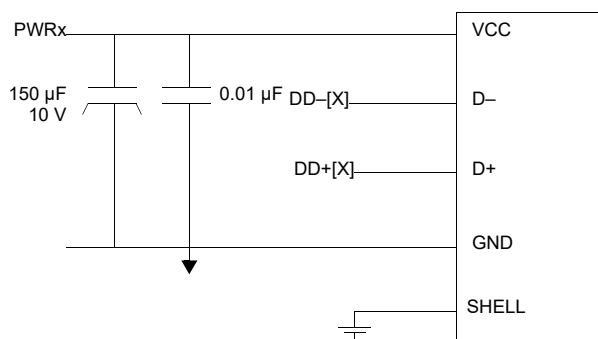
Figure 3. USB Downstream Port Connection

LED Connections

The following is a schematic of the LED circuitry.

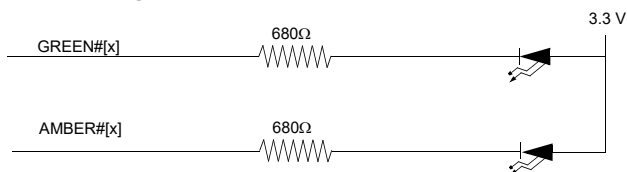
Figure 4. USB Downstream Port Connection

System Block Diagram

Figure 5. Sample Schematic for 4-Port Self Powered Configuration

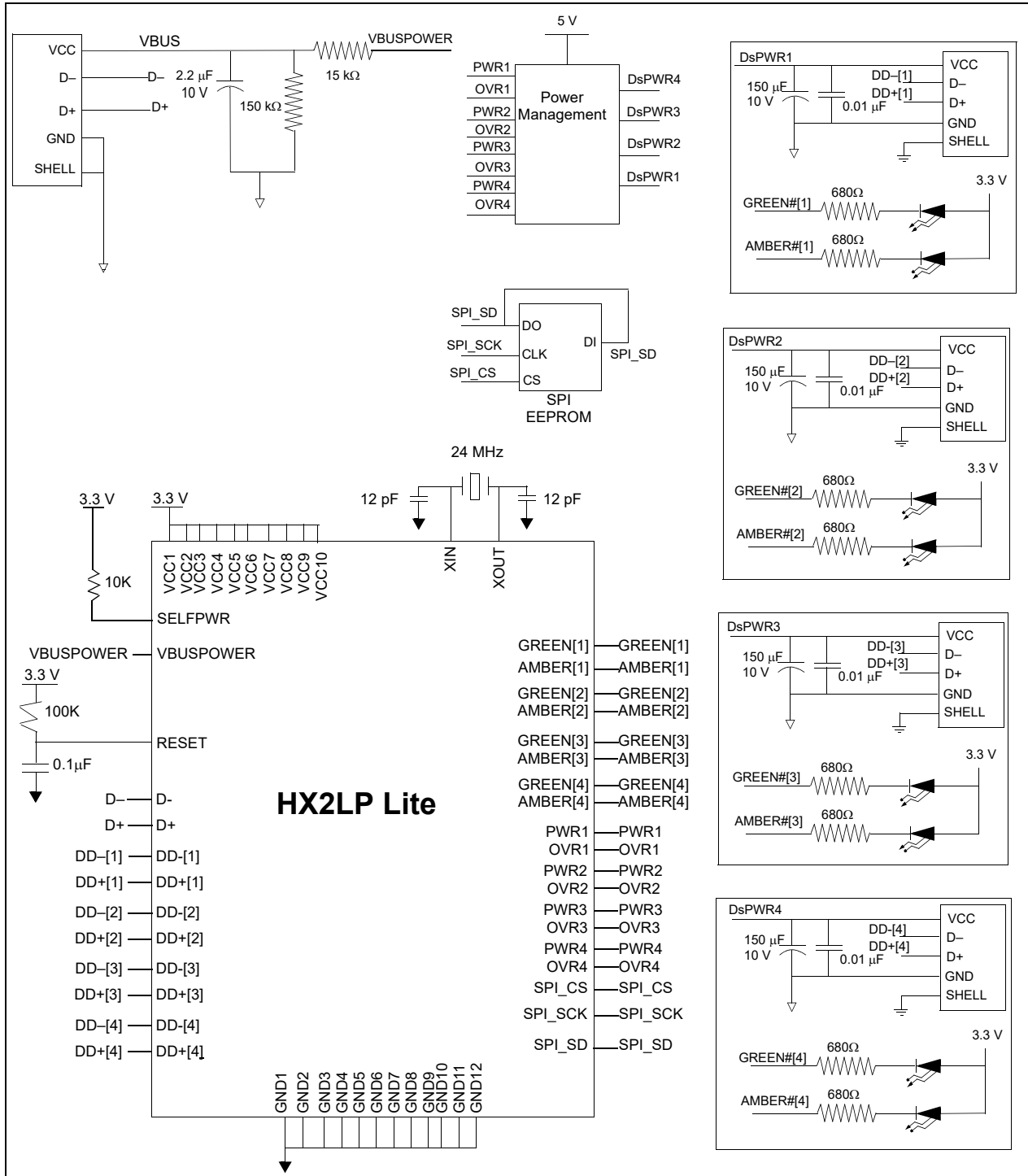



Absolute Maximum Ratings

Storage temperature	-65 °C to +150 °C
Ambient temperature with power applied:	
Commercial	0 °C to +70 °C
Industrial	-40 °C to 85 °C
Automotive	-40 °C to 85 °C
Supply voltage to ground potential	-0.5 V to +4.0 V
DC voltage applied to outputs in high Z State	-0.5 V to $V_{CC} + 0.5 V$
Power dissipation (4 HS ports)	0.9 W
Static discharge voltage	> 2000 V
Maximum output sink current per I/O	10 mA

Operating Conditions

T_A (Ambient temperature under bias):	
Commercial	0 °C to +70 °C
Industrial	-40 °C to 85 °C
Automotive	-40 °C to 85 °C
Supply voltage	+3.15 V to +3.45 V
Ground voltage	0 V
Oscillator or Crystal Frequency (F_{OSC}), parallel resonant, 12-pF load capacitance, 0.5 mW	24 MHz \pm 0.05%

Electrical Characteristics

DC Electrical Characteristics

Parameter	Description	Conditions	Min	Typ	Max	Unit
V_{CC}	Supply voltage		3.15	3.3	3.45	V
V_{CC} RampUp	Ramp rate on V_{CC}		-	-	18	V/ms
V_{IH}	Input high voltage		2	-	5.25	V
V_{IL}	Input low voltage		-0.5	-	0.8	V
I_I	Input leakage current	$0 < V_{IN} < V_{CC}$	-	-	± 10	μA
V_{OH}	Output voltage high	$I_{OUT} = 4 \text{ mA}$	2.4	-		V
V_{OL}	Output low voltage	$I_{OUT} = -4 \text{ mA}$	-	-	0.4	V
I_{OH}	Output current high		-	-	4	mA
I_{OL}	Output current low		-	-	4	mA
C_{IN}	Input pin capacitance		-	-	10	pF
I_{SUSP}	Suspend current		-	80	-	μA
I_{CC}	Supply Current					
	4 Active Ports	Full speed host, full speed devices	-	86	110	mA
		High speed host, high speed devices	-	231	260	mA
		High speed host, full speed devices	-	154	180	mA
	2 Active Ports	Full speed host, full speed devices	-	77	100	mA
		High speed host, high speed devices	-	163	190	mA
		High speed host, Full speed devices	-	136	160	mA
	No Active Ports	Full speed host	-	65	90	mA
		High speed host	-	93	120	mA

USB Transceiver

USB 2.0 certified in full, low, and high speed modes.

AC Electrical Characteristics

Both the upstream USB transceiver and all four downstream transceivers have passed the USB-IF USB 2.0 Electrical Certification Testing.



Table 10. Serial Peripheral Interface

Parameter	Description	Conditions	Min	Typ	Max	Unit
	Clock rise/fall time		–	–	500	ns
	Clock frequency		–	–	250	kHz
	Data setup time		50	–	–	ns
	Hold time		100	–	–	ns
	Reset period		1.9	–	–	ms

Ordering Information

Ordering Code	Package Type
CY7C65621-56LTXC	56-pin QFN 2-Port
CY7C65621-56LTXI	
CY7C65621-56LTXCT	56-pin QFN 2-Port – Tape and Reel
CY7C65621-56LTXIT	
CY7C65631-56LTXC	56-pin QFN 4-Port
CY7C65631-56LTXI	
CY7C65631-56LTXCT	56-pin QFN 4-Port – Tape and Reel
CY7C65631-56LTXIT	
CY4606	CY7C65631 USB 2.0 4-Port hub reference design kit
CY4605	CY7C65621 USB 2.0 2-Port hub reference design kit

Ordering Code Definitions

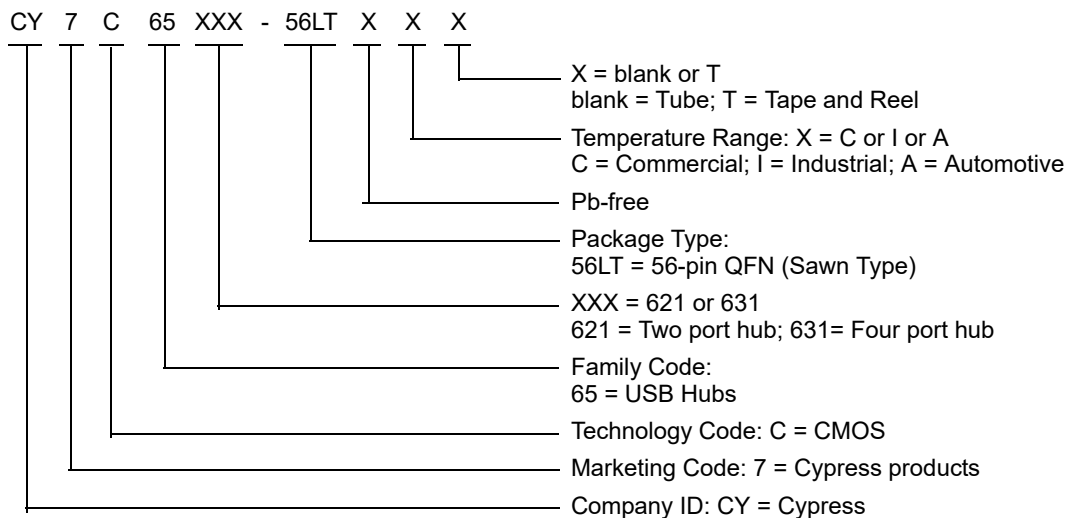



Acronyms

Table 11. Acronyms Used in this Document

Acronym	Description
EEPROM	electrically erasable programmable read-only memory
I/O	input/output
LED	light-emitting diode
LSB	least-significant bit
MSB	most-significant bit
PLL	phase locked loop
SIE	serial interface engine
SPI	serial peripheral interface
ROM	read-only memory
QFN	quad-flat no-leads
TT	transaction translator
USB	universal serial bus
USB-IF	universal serial bus implementor's forum

Document Conventions

Units of Measure

Table 12. Units of Measure

Symbol	Unit of Measure
°C	degree Celsius
kHz	kilohertz
k Ω	kilohm
MHz	megahertz
μ A	microampere
μ F	microfarad
mA	milliampere
mm	millimeter
ms	millisecond
mW	milliwatt
ns	nanosecond
Ω	ohm
%	percent
pF	picofarad
V	volt
W	watt



Document History Page

Document Title: CY7C65621/31, EZ-USB HX2LP Lite™ Low Power USB 2.0 Hub Controller Family				
Document Number: 001-52934				
Rev.	ECN	Orig. of Change	Submission Date	Description of Change
**	2683316	OGC / PYRS	04/15/2009	New data sheet.
*A	2937054	STVC	05/25/2010	Updated table formats across the document. Updated Pin Description : Updated Table 3 : Updated details in "Description" column corresponding to Pin 51 and Pin 53. Updated Ordering Information : No change in part numbers. Rearranged parts in alphabetical order. Updated Package Diagram : spec 51-85187 – Changed revision from *C to *E. Removed spec 51-85144 *G. Updated to new template.
*B	2953993	DSG	06/16/2010	Updated Ordering Information : Updated part numbers.
*C	3180356	ODC	02/23/2011	Removed Automotive Temperature Range related information in all instances across the document. Updated Ordering Information : No change in part numbers. Added Ordering Code Definitions . Added Acronyms and Units of Measure . Updated to new template. Completing Sunset Review.
*D	3404912	AASI	10/13/2011	Added watermark "Not Recommended for New Designs" across the document.
*E	3453432	ASHC	12/07/2011	Removed watermark "Not Recommended for New Designs" across the document. Updated Package Diagram : spec 51-85187 – Changed revision from *E to *F. Updated to new template.
*F	3846590	PDAV	12/19/2012	Updated Features (Added Industrial Grade and Automotive Grade information). Updated Absolute Maximum Ratings (Added Industrial Grade and Automotive Grade information). Updated Operating Conditions (Added Industrial Grade and Automotive Grade information). Updated Ordering Information (Updated part numbers).
*G	4799279	GINS	06/16/2015	Updated Package Diagram : spec 51-85187 – Changed revision from *F to *G. Updated to new template. Completing Sunset Review.
*H	5316710	HBM	06/21/2016	Updated System Block Diagram : Updated Figure 5 . Completing Sunset Review.
*I	5751250	HARA	05/26/2017	Updated Cypress Logo and Copyright.
*J	6582773	MARF	05/28/2019	Updated to new template. Completing Sunset Review.



Sales, Solutions, and Legal Information

Worldwide Sales and Design Support

Cypress maintains a worldwide network of offices, solution centers, manufacturer's representatives, and distributors. To find the office closest to you, visit us at [Cypress Locations](#).

Products

Arm® Cortex® Microcontrollers	cypress.com/arm
Automotive	cypress.com/automotive
Clocks & Buffers	cypress.com/clocks
Interface	cypress.com/interface
Internet of Things	cypress.com/iot
Memory	cypress.com/memory
Microcontrollers	cypress.com/mcu
PSoC	cypress.com/psoc
Power Management ICs	cypress.com/pmic
Touch Sensing	cypress.com/touch
USB Controllers	cypress.com/usb
Wireless Connectivity	cypress.com/wireless

PSoC® Solutions

[PSoC 1](#) | [PSoC 3](#) | [PSoC 4](#) | [PSoC 5LP](#) | [PSoC 6 MCU](#)

Cypress Developer Community

[Community](#) | [Projects](#) | [Video](#) | [Blogs](#) | [Training](#) | [Components](#)

Technical Support

cypress.com/support

© Cypress Semiconductor Corporation, 2009–2019. This document is the property of Cypress Semiconductor Corporation and its subsidiaries ("Cypress"). This document, including any software or firmware included or referenced in this document ("Software"), is owned by Cypress under the intellectual property laws and treaties of the United States and other countries worldwide. Cypress reserves all rights under such laws and treaties and does not, except as specifically stated in this paragraph, grant any license under its patents, copyrights, trademarks, or other intellectual property rights. If the Software is not accompanied by a license agreement and you do not otherwise have a written agreement with Cypress governing the use of the Software, then Cypress hereby grants you a personal, non-exclusive, nontransferable license (without the right to sublicense) (1) under its copyright rights in the Software (a) for Software provided in source code form, to modify and reproduce the Software solely for use with Cypress hardware products, only internally within your organization, and (b) to distribute the Software in binary code form externally to end users (either directly or indirectly through resellers and distributors), solely for use on Cypress hardware product units, and (2) under those claims of Cypress's patents that are infringed by the Software (as provided by Cypress, unmodified) to make, use, distribute, and import the Software solely for use with Cypress hardware products. Any other use, reproduction, modification, translation, or compilation of the Software is prohibited.

TO THE EXTENT PERMITTED BY APPLICABLE LAW, CYPRESS MAKES NO WARRANTY OF ANY KIND, EXPRESS OR IMPLIED, WITH REGARD TO THIS DOCUMENT OR ANY SOFTWARE OR ACCOMPANYING HARDWARE, INCLUDING, BUT NOT LIMITED TO, THE IMPLIED WARRANTIES OF MERCHANTABILITY AND FITNESS FOR A PARTICULAR PURPOSE. No computing device can be absolutely secure. Therefore, despite security measures implemented in Cypress hardware or software products, Cypress shall have no liability arising out of any security breach, such as unauthorized access to or use of a Cypress product. CYPRESS DOES NOT REPRESENT, WARRANT, OR GUARANTEE THAT CYPRESS PRODUCTS, OR SYSTEMS CREATED USING CYPRESS PRODUCTS, WILL BE FREE FROM CORRUPTION, ATTACK, VIRUSES, INTERFERENCE, HACKING, DATA LOSS OR THEFT, OR OTHER SECURITY INTRUSION (collectively, "Security Breach"). Cypress disclaims any liability relating to any Security Breach, and you shall and hereby do release Cypress from any claim, damage, or other liability arising from any Security Breach. In addition, the products described in these materials may contain design defects or errors known as errata which may cause the product to deviate from published specifications. To the extent permitted by applicable law, Cypress reserves the right to make changes to this document without further notice. Cypress does not assume any liability arising out of the application or use of any product or circuit described in this document. Any information provided in this document, including any sample design information or programming code, is provided only for reference purposes. It is the responsibility of the user of this document to properly design, program, and test the functionality and safety of any application made of this information and any resulting product. "High-Risk Device" means any device or system whose failure could cause personal injury, death, or property damage. Examples of High-Risk Devices are weapons, nuclear installations, surgical implants, and other medical devices. "Critical Component" means any component of a High-Risk Device whose failure to perform can be reasonably expected to cause, directly or indirectly, the failure of the High-Risk Device, or to affect its safety or effectiveness. Cypress is not liable, in whole or in part, and you shall and hereby do release Cypress from any claim, damage, or other liability arising from any use of a Cypress product as a Critical Component in a High-Risk Device. You shall indemnify and hold Cypress, its directors, officers, employees, agents, affiliates, distributors, and assigns harmless from and against all claims, costs, damages, and expenses, arising out of any claim, including claims for product liability, personal injury or death, or property damage arising from any use of a Cypress product as a Critical Component in a High-Risk Device. Cypress products are not intended or authorized for use as a Critical Component in any High-Risk Device except to the limited extent that (i) Cypress's published data sheet for the product explicitly states Cypress has qualified the product for use in a specific High-Risk Device, or (ii) Cypress has given you advance written authorization to use the product as a Critical Component in the specific High-Risk Device and you have signed a separate indemnification agreement.

Cypress, the Cypress logo, Spansion, the Spansion logo, and combinations thereof, WICED, PSoC, CapSense, EZ-USB, F-RAM, and Traveo are trademarks or registered trademarks of Cypress in the United States and other countries. For a more complete list of Cypress trademarks, visit cypress.com. Other names and brands may be claimed as property of their respective owners.

OUR CERTIFICATE

DiGi provide top-quality products and perfect service for customer worldwide through standardization, technological innovation and continuous improvement. DiGi through third-party certification, we stricly control the quality of products and services. Welcome your RFQ to

Email: Info@DiGi-Electronics.com



Tel: +00 852-30501935

RFQ Email: Info@DiGi-Electronics.com

DiGi is a global authorized distributor of electronic components.