

IPTC014N10NM5ATMA1 Datasheet

ligi-electronics.com

Photo Not Available

<https://www.DiGi-Electronics.com>

DiGi Electronics Part Number	IPTC014N10NM5ATMA1-DG
Manufacturer	Infineon Technologies
Manufacturer Product Number	IPTC014N10NM5ATMA1
Description	OPTIMOS 5 POWER MOSFET
Detailed Description	N-Channel 100 V 37A (Ta), 365A (Tc) 3.8W (Ta), 375 W (Tc) Surface Mount PG-HDSOP-16-2

This model IPTC014N10NM5ATMA1 is available at DiGi Electronics.

DiGi Electronics offers a global database of semiconductor and electronic component datasheets.

We welcome your inquiries regarding pricing, lead time, or other product-related questions.

 [Request a Quote](#)

 [Datasheet Search](#)



Tel: +00 852-30501935

RFQ Email: Info@DiGi-Electronics.com

DiGi is a global authorized distributor of electronic components.

Purchase and inquiry

Manufacturer Product Number:

IPTC014N10NM5ATMA1

Series:

OptiMOS™ 5

FET Type:

N-Channel

Drain to Source Voltage (Vdss):

100 V

Drive Voltage (Max Rds On, Min Rds On):

6V, 10V

Vgs(th) (Max) @ Id:

3.8V @ 280µA

Vgs (Max):

±20V

FET Feature:

-

Operating Temperature:

-55°C ~ 175°C (Tj)

Supplier Device Package:

PG-HDSOP-16-2

Manufacturer:

Infineon Technologies

Product Status:

Active

Technology:

MOSFET (Metal Oxide)

Current - Continuous Drain (Id) @ 25°C:

37A (Ta), 365A (Tc)

Rds On (Max) @ Id, Vgs:

1.4mOhm @ 150A, 10V

Gate Charge (Qg) (Max) @ Vgs:

211 nC @ 10 V

Input Capacitance (Ciss) (Max) @ Vds:

16000 pF @ 50 V

Power Dissipation (Max):

3.8W (Ta), 375W (Tc)

Mounting Type:

Surface Mount

Package / Case:

16-PowerSOP Module

Environmental & Export classification

RoHS Status:

ROHS3 Compliant

REACH Status:

REACH Unaffected

HTSUS:

8541.29.0095

Moisture Sensitivity Level (MSL):

1 (Unlimited)

ECCN:

EAR99

MOSFET

OptiMOS™ 5 Power-Transistor, 100 V

Features

- N-channel
- Very low on-resistance $R_{DS(on)}$
- Superior thermal resistance
- 100% avalanche tested
- Pb-free lead plating; RoHS compliant
- Halogen-free according to IEC61249-2-21

Product validation

Fully qualified according to JEDEC for Industrial Applications

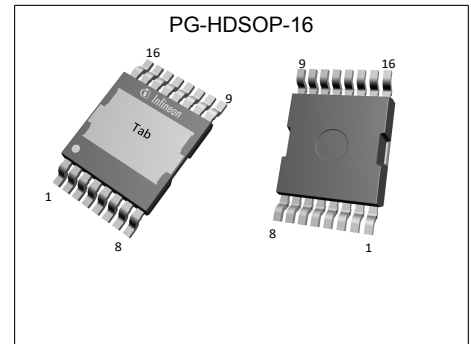
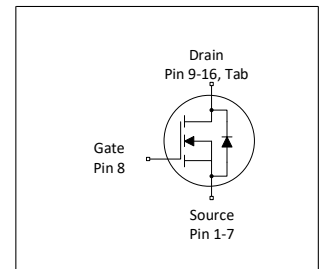

Table 1 Key Performance Parameters

Parameter	Value	Unit
V_{DS}	100	V
$R_{DS(on),max}$	1.4	$m\Omega$
I_D	365	A
Q_{oss}	213	nC
Q_G	168	nC



RoHS

Type / Ordering Code	Package	Marking	Related Links
IPTC014N10NM5	PG-HDSOP-16	14N10NM5	-



OptiMOS™ 5 Power-Transistor, 100 V

IPTC014N10NM5

Table of Contents

Description	1
Maximum ratings	3
Thermal characteristics	3
Electrical characteristics	4
Electrical characteristics diagrams	6
Package Outlines	10
Revision History	13
Trademarks	13
Disclaimer	13

OptiMOS™ 5 Power-Transistor, 100 V

IPTC014N10NM5

1 Maximum ratings

at $T_A=25\text{ °C}$, unless otherwise specified

Table 2 Maximum ratings

Parameter	Symbol	Values			Unit	Note / Test Condition
		Min.	Typ.	Max.		
Continuous drain current ¹⁾	I_D	-	-	365 258 216 37	A	$V_{GS}=10\text{ V}$, $T_C=25\text{ °C}$ $V_{GS}=10\text{ V}$, $T_C=100\text{ °C}$ $V_{GS}=6\text{ V}$, $T_C=100\text{ °C}$ $V_{GS}=10\text{ V}$, $T_A=25\text{ °C}$, $R_{thJA}=40\text{ °C/W}^2)$
Pulsed drain current ³⁾	$I_{D,pulse}$	-	-	1460	A	$T_A=25\text{ °C}$
Avalanche energy, single pulse ⁴⁾	E_{AS}	-	-	775	mJ	$I_D=150\text{ A}$, $R_{GS}=25\text{ }\Omega$
Gate source voltage	V_{GS}	-20	-	20	V	-
Power dissipation	P_{tot}	-	-	375 3.8	W	$T_C=25\text{ °C}$ $T_A=25\text{ °C}$, $R_{thJA}=40\text{ °C/W}^2)$
Operating and storage temperature	T_j , T_{stg}	-55	-	175	°C	IEC climatic category; DIN IEC 68-1: 55/175/56

2 Thermal characteristics

Table 3 Thermal characteristics

Parameter	Symbol	Values			Unit	Note / Test Condition
		Min.	Typ.	Max.		
Thermal resistance, junction - case	R_{thJC}	-	0.2	0.4	°C/W	-
Thermal resistance, junction - ambient, 6 cm ² cooling area ²⁾	R_{thJA}	-	-	40	°C/W	-
Thermal resistance, junction - ambient, minimal footprint	R_{thJA}	-	-	62	°C/W	-

¹⁾ Rating refers to the product only with datasheet specified absolute maximum values, maintaining case temperature as specified. For other case temperatures please refer to Diagram 2. De-rating will be required based on the actual environmental conditions.

²⁾ Device on 40 mm x 40 mm x 1.5 mm epoxy PCB FR4 with 6 cm² (one layer, 70 µm thick) copper area for drain connection. PCB is vertical in still air.

³⁾ See Diagram 3 for more detailed information

⁴⁾ See Diagram 13 for more detailed information

OptiMOS™ 5 Power-Transistor, 100 V

IPTC014N10NM5

3 Electrical characteristics

at $T_j=25\text{ °C}$, unless otherwise specified

Table 4 Static characteristics

Parameter	Symbol	Values			Unit	Note / Test Condition
		Min.	Typ.	Max.		
Drain-source breakdown voltage	$V_{(BR)DSS}$	100	-	-	V	$V_{GS}=0\text{ V}$, $I_D=1\text{ mA}$
Gate threshold voltage	$V_{GS(th)}$	2.2	3.0	3.8	V	$V_{DS}=V_{GS}$, $I_D=280\text{ }\mu\text{A}$
Zero gate voltage drain current	I_{DSS}	-	0.1 10	5.0 100	μA	$V_{DS}=100\text{ V}$, $V_{GS}=0\text{ V}$, $T_j=25\text{ °C}$ $V_{DS}=100\text{ V}$, $V_{GS}=0\text{ V}$, $T_j=125\text{ °C}$
Gate-source leakage current	I_{GSS}	-	10	100	nA	$V_{GS}=20\text{ V}$, $V_{DS}=0\text{ V}$
Drain-source on-state resistance	$R_{DS(on)}$	-	1.3 1.6	1.4 2.0	m Ω	$V_{GS}=10\text{ V}$, $I_D=150\text{ A}$ $V_{GS}=6\text{ V}$, $I_D=75\text{ A}$
Gate resistance ¹⁾	R_G	-	1.4	2.1	Ω	-
Transconductance	g_{fs}	140	280	-	S	$ V_{DS} \geq 2 I_D R_{DS(on)max}$, $I_D=100\text{ A}$

Table 5 Dynamic characteristics

Parameter	Symbol	Values			Unit	Note / Test Condition
		Min.	Typ.	Max.		
Input capacitance ¹⁾	C_{iss}	-	12000	16000	pF	$V_{GS}=0\text{ V}$, $V_{DS}=50\text{ V}$, $f=1\text{ MHz}$
Output capacitance ¹⁾	C_{oss}	-	1800	2300	pF	$V_{GS}=0\text{ V}$, $V_{DS}=50\text{ V}$, $f=1\text{ MHz}$
Reverse transfer capacitance ¹⁾	C_{rss}	-	80	140	pF	$V_{GS}=0\text{ V}$, $V_{DS}=50\text{ V}$, $f=1\text{ MHz}$
Turn-on delay time	$t_{d(on)}$	-	36	-	ns	$V_{DD}=50\text{ V}$, $V_{GS}=10\text{ V}$, $I_D=100\text{ A}$, $R_{G,ext}=1.6\text{ }\Omega$
Rise time	t_r	-	30	-	ns	$V_{DD}=50\text{ V}$, $V_{GS}=10\text{ V}$, $I_D=100\text{ A}$, $R_{G,ext}=1.6\text{ }\Omega$
Turn-off delay time	$t_{d(off)}$	-	85	-	ns	$V_{DD}=50\text{ V}$, $V_{GS}=10\text{ V}$, $I_D=100\text{ A}$, $R_{G,ext}=1.6\text{ }\Omega$
Fall time	t_f	-	30	-	ns	$V_{DD}=50\text{ V}$, $V_{GS}=10\text{ V}$, $I_D=100\text{ A}$, $R_{G,ext}=1.6\text{ }\Omega$

Table 6 Gate charge characteristics²⁾

Parameter	Symbol	Values			Unit	Note / Test Condition
		Min.	Typ.	Max.		
Gate to source charge	Q_{gs}	-	53	-	nC	$V_{DD}=50\text{ V}$, $I_D=100\text{ A}$, $V_{GS}=0\text{ to }10\text{ V}$
Gate charge at threshold	$Q_{g(th)}$	-	36	-	nC	$V_{DD}=50\text{ V}$, $I_D=100\text{ A}$, $V_{GS}=0\text{ to }10\text{ V}$
Gate to drain charge ¹⁾	Q_{gd}	-	34	51	nC	$V_{DD}=50\text{ V}$, $I_D=100\text{ A}$, $V_{GS}=0\text{ to }10\text{ V}$
Switching charge	Q_{sw}	-	51	-	nC	$V_{DD}=50\text{ V}$, $I_D=100\text{ A}$, $V_{GS}=0\text{ to }10\text{ V}$
Gate charge total ¹⁾	Q_g	-	168	211	nC	$V_{DD}=50\text{ V}$, $I_D=100\text{ A}$, $V_{GS}=0\text{ to }10\text{ V}$
Gate plateau voltage	$V_{plateau}$	-	4.4	-	V	$V_{DD}=50\text{ V}$, $I_D=100\text{ A}$, $V_{GS}=0\text{ to }10\text{ V}$
Output charge ¹⁾	Q_{oss}	-	213	285	nC	$V_{DS}=50\text{ V}$, $V_{GS}=0\text{ V}$

¹⁾ Defined by design. Not subject to production test.

²⁾ See "Gate charge waveforms" for parameter definition



OptiMOS™ 5 Power-Transistor, 100 V

IPTC014N10NM5

Table 7 Reverse diode

Parameter	Symbol	Values			Unit	Note / Test Condition
		Min.	Typ.	Max.		
Diode continuous forward current	I_S	-	-	320	A	$T_C=25\text{ °C}$
Diode pulse current	$I_{S,pulse}$	-	-	1460	A	$T_C=25\text{ °C}$
Diode forward voltage	V_{SD}	-	0.88	1.0	V	$V_{GS}=0\text{ V}, I_F=150\text{ A}, T_j=25\text{ °C}$
Reverse recovery time ¹⁾	t_{rr}	-	103	206	ns	$V_R=50\text{ V}, I_F=100\text{ A}, di_F/dt=100\text{ A}/\mu\text{s}$
Reverse recovery charge ¹⁾	Q_{rr}	-	316	632	nC	$V_R=50\text{ V}, I_F=100\text{ A}, di_F/dt=100\text{ A}/\mu\text{s}$

¹⁾ Defined by design. Not subject to production test.

OptiMOS™ 5 Power-Transistor, 100 V

IPTC014N10NM5

4 Electrical characteristics diagrams

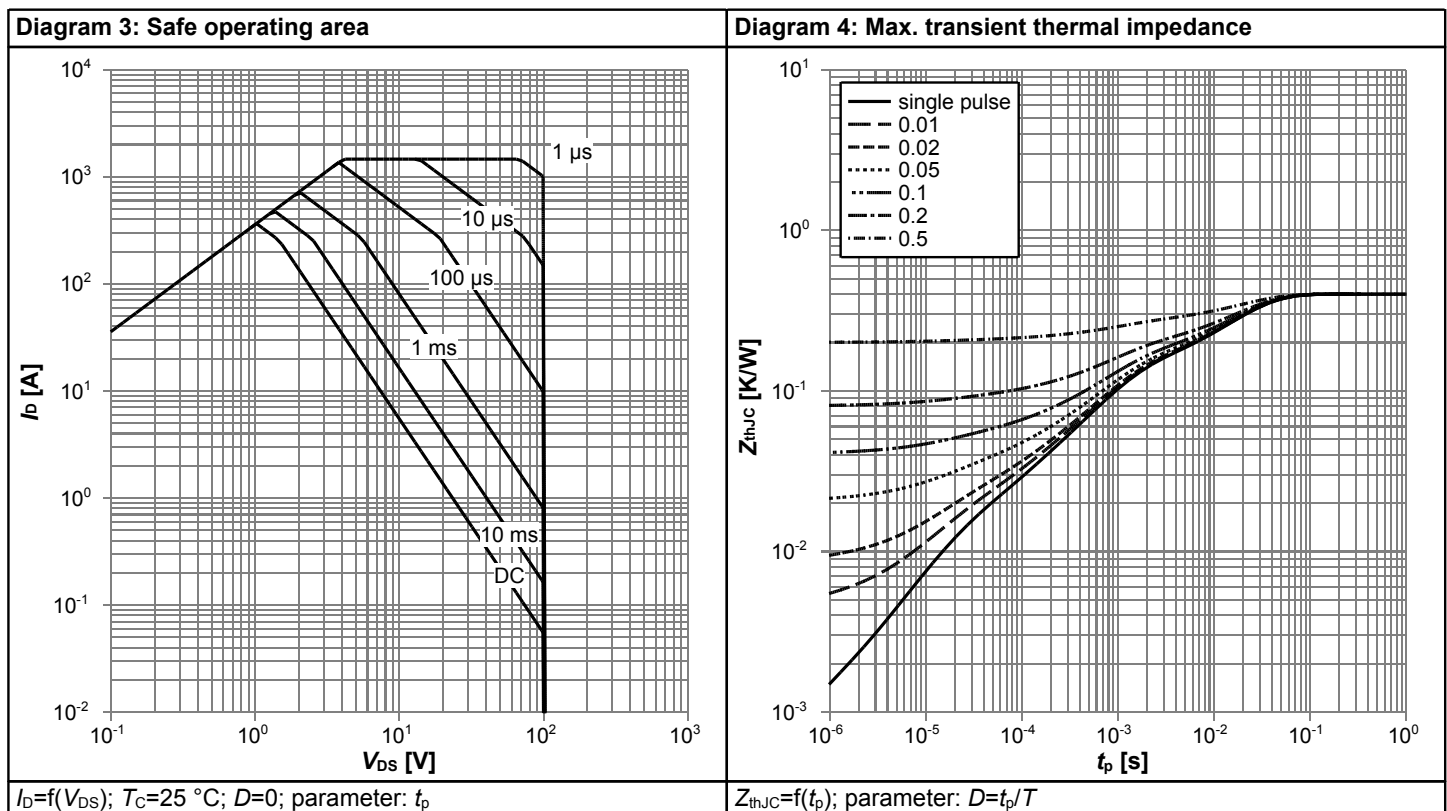
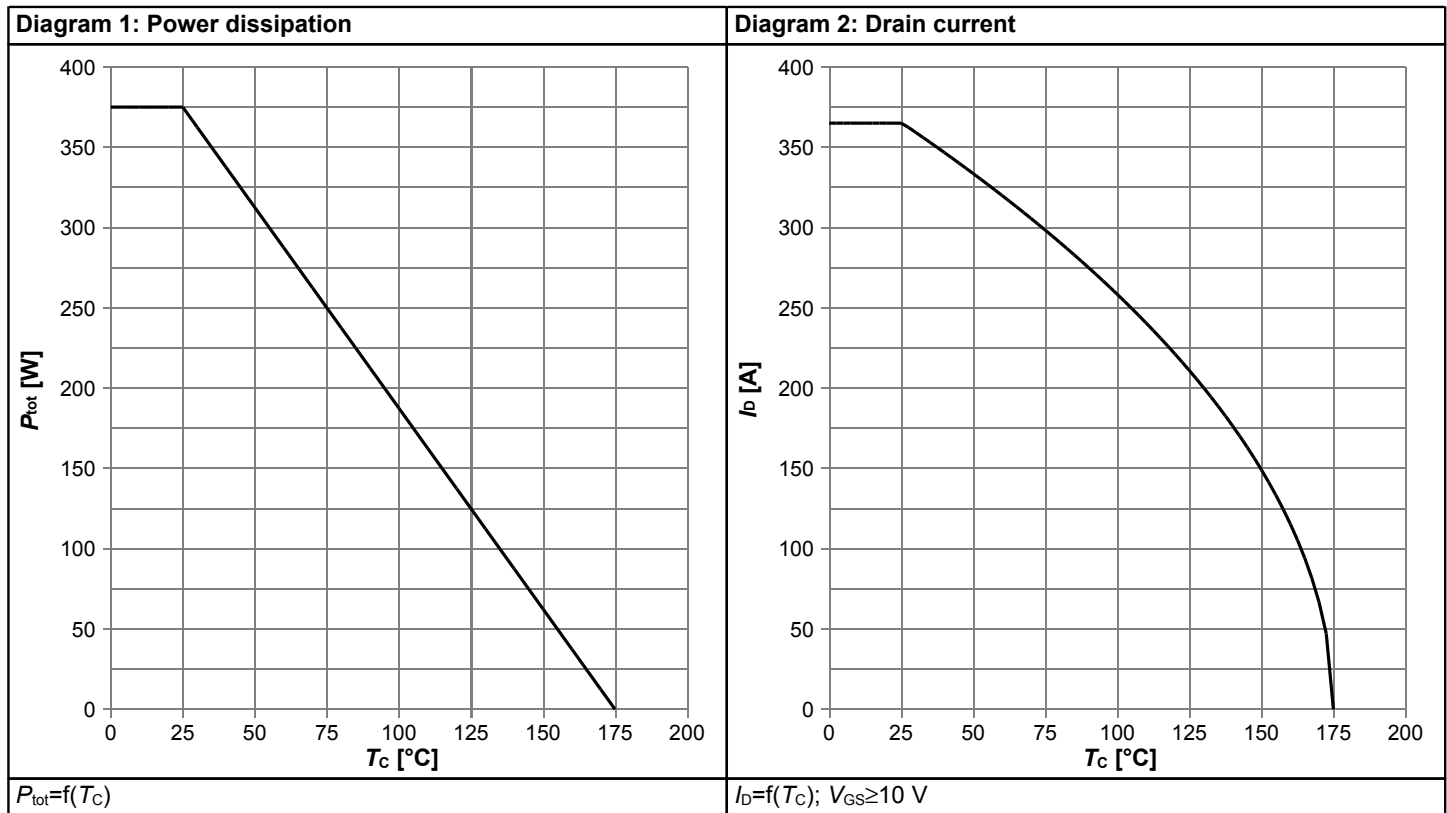

OptiMOS™ 5 Power-Transistor, 100 V

IPTC014N10NM5

Diagram 5: Typ. output characteristics



 $I_D = f(V_{DS})$, $T_j = 25^\circ\text{C}$; parameter: V_{GS}

Diagram 6: Typ. drain-source on resistance

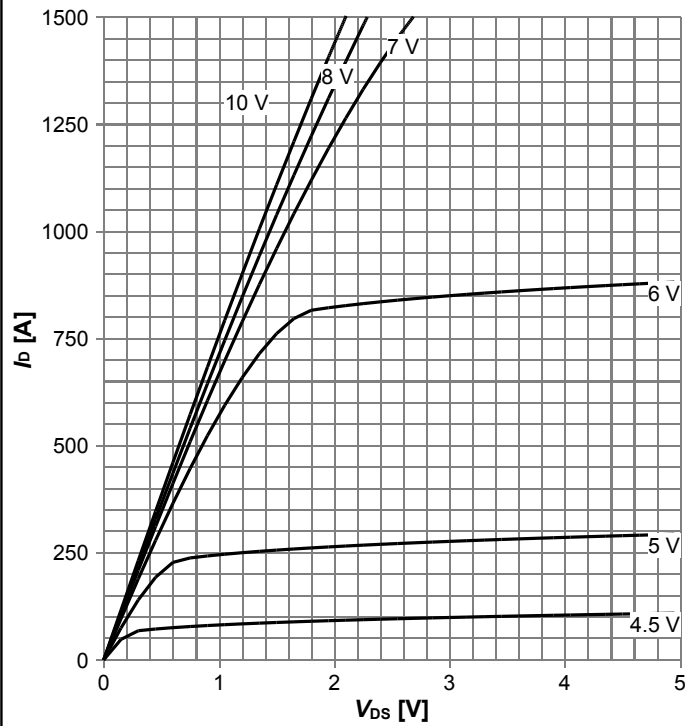

 $R_{DS(on)} = f(I_D)$, $T_j = 25^\circ\text{C}$; parameter: V_{GS}

Diagram 7: Typ. transfer characteristics

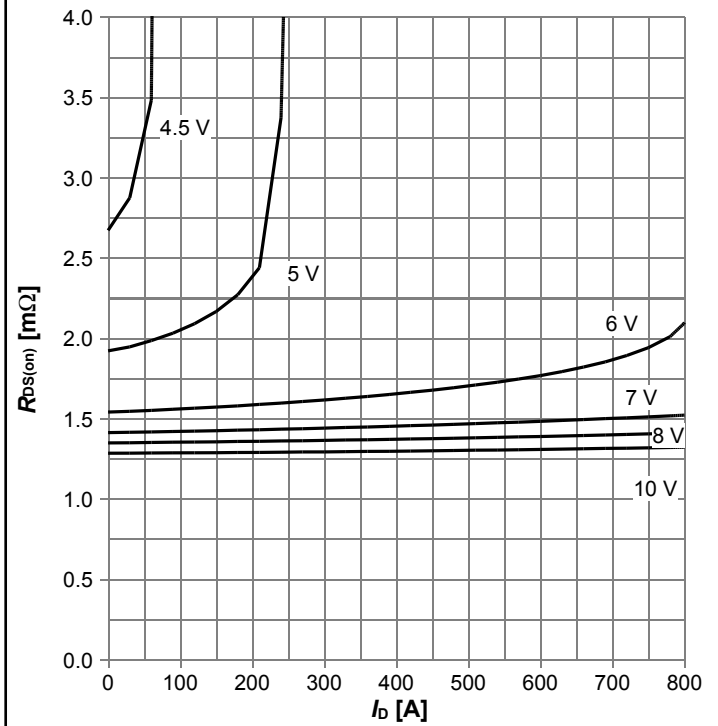

 $I_D = f(V_{GS})$, $|V_{DS}| > 2|I_D|R_{DS(on)max}$; parameter: T_j

Diagram 8: Typ. drain-source on resistance

 $R_{DS(on)} = f(V_{GS})$, $I_D = 150\text{ A}$; parameter: T_j

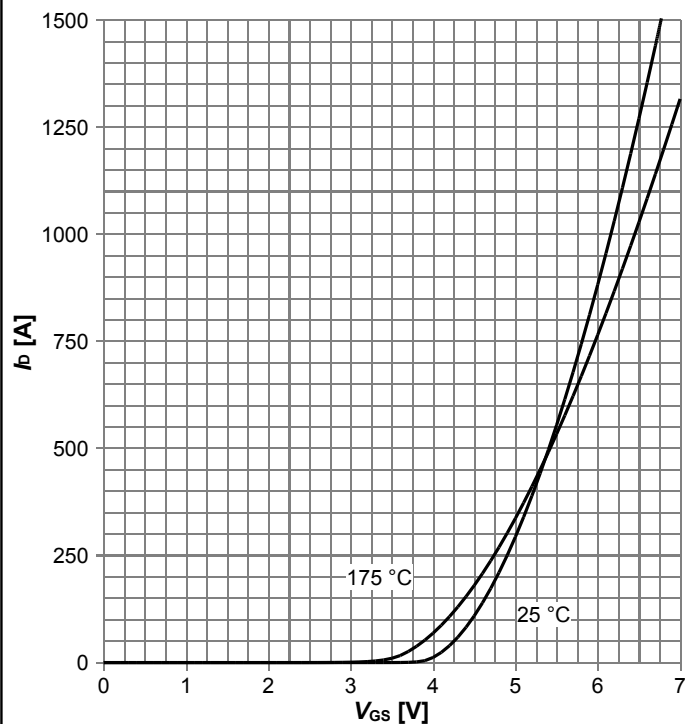
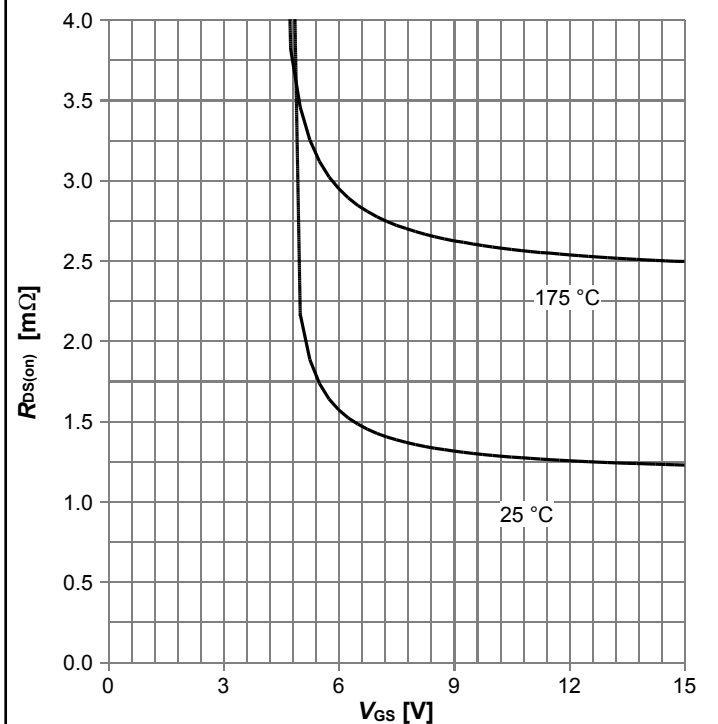

OptiMOS™ 5 Power-Transistor, 100 V
IPTC014N10NM5

Diagram 9: Normalized drain-source on resistance

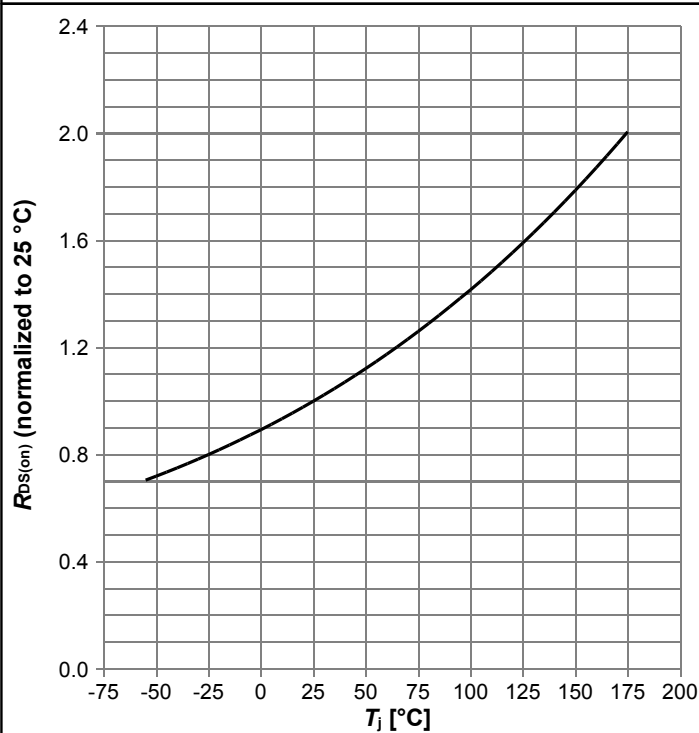

$R_{DS(on)}=f(T_j)$, $I_D=150\text{ A}$, $V_{GS}=10\text{ V}$

Diagram 10: Typ. gate threshold voltage

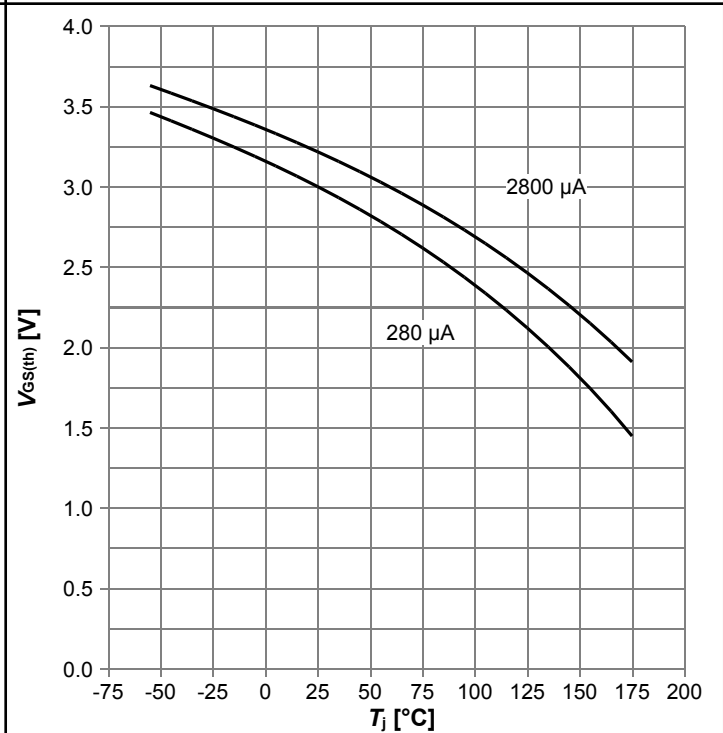

$V_{GS(th)}=f(T_j)$, $V_{GS}=V_{DS}$; parameter: I_D

Diagram 11: Typ. capacitances

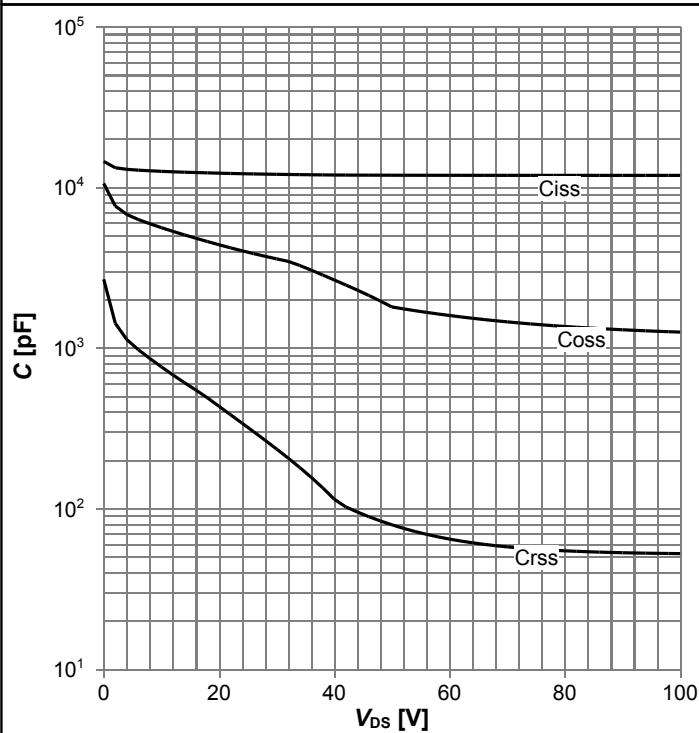

$C=f(V_{DS})$; $V_{GS}=0\text{ V}$; $f=1\text{ MHz}$

Diagram 12: Forward characteristics of reverse diode

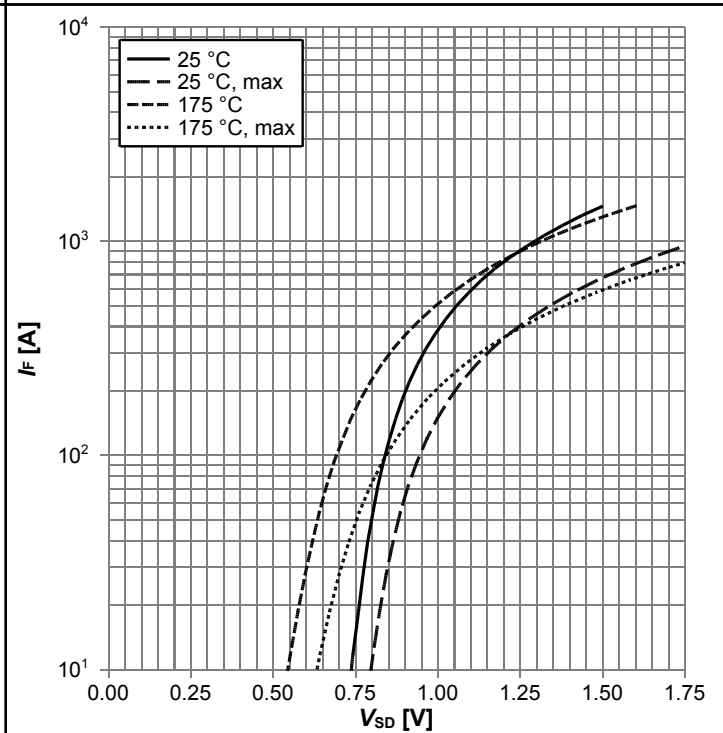

$I_F=f(V_{SD})$; parameter: T_j



OptiMOS™ 5 Power-Transistor, 100 V
IPTC014N10NM5

Diagram 13: Avalanche characteristics

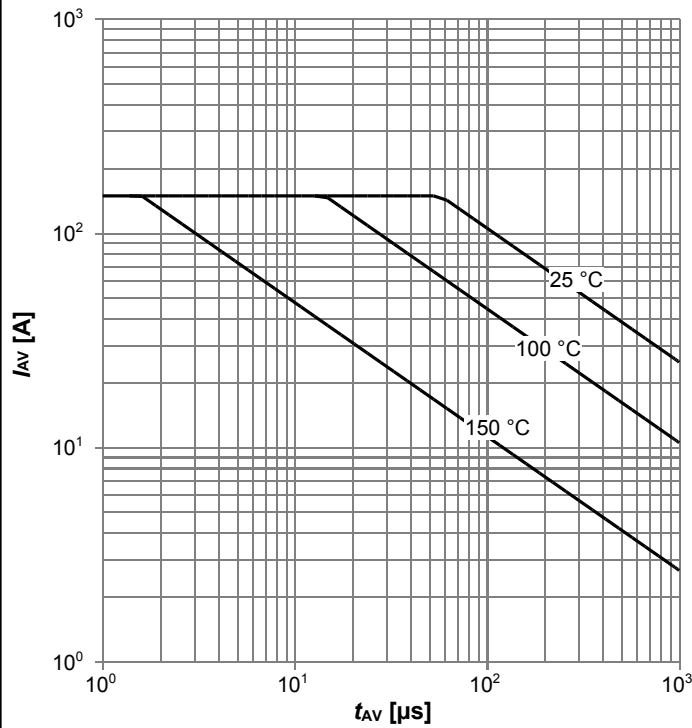

$I_{AS}=f(t_{AV}); R_{GS}=25 \Omega$; parameter: $T_{j,start}$

Diagram 14: Typ. gate charge

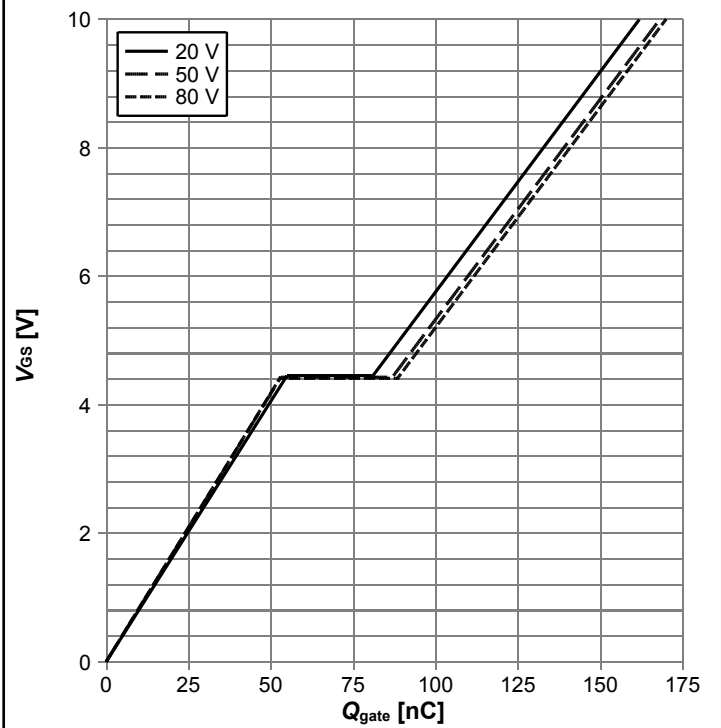

$V_{GS}=f(Q_{gate}), I_D=100$ A pulsed, $T_j=25$ °C; parameter: V_{DD}

Diagram 15: Drain-source breakdown voltage

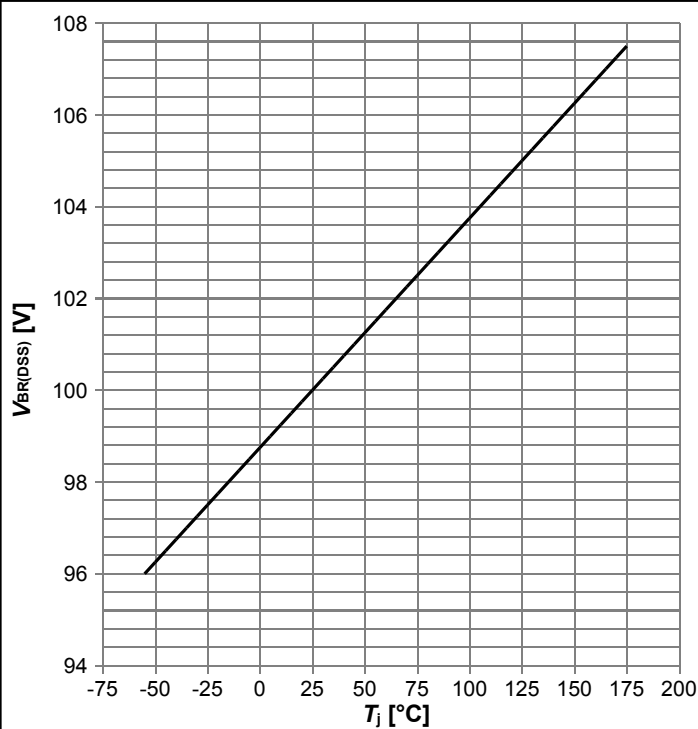

$V_{BR(DSS)}=f(T_j); I_D=1$ mA

Diagram Gate charge waveforms

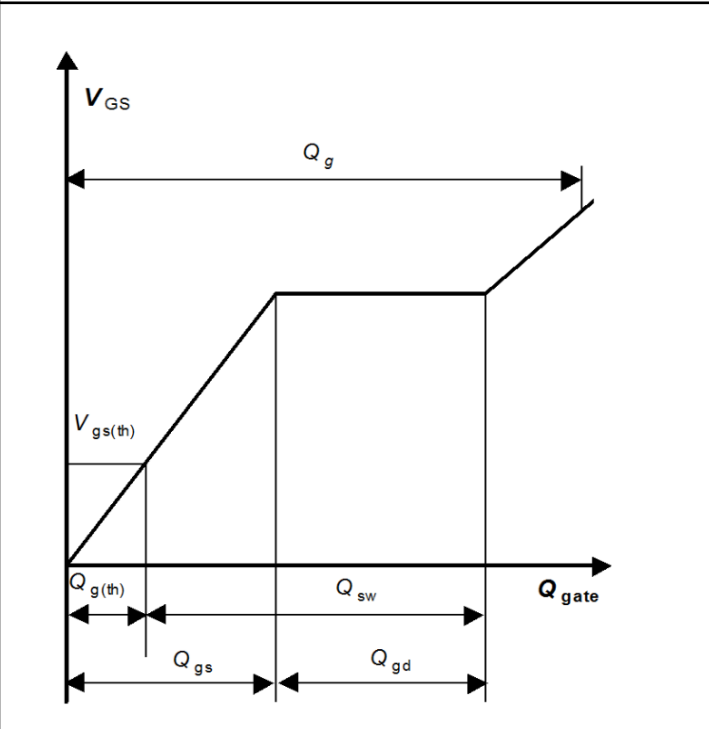

OptiMOS™ 5 Power-Transistor, 100 V

IPTC014N10NM5

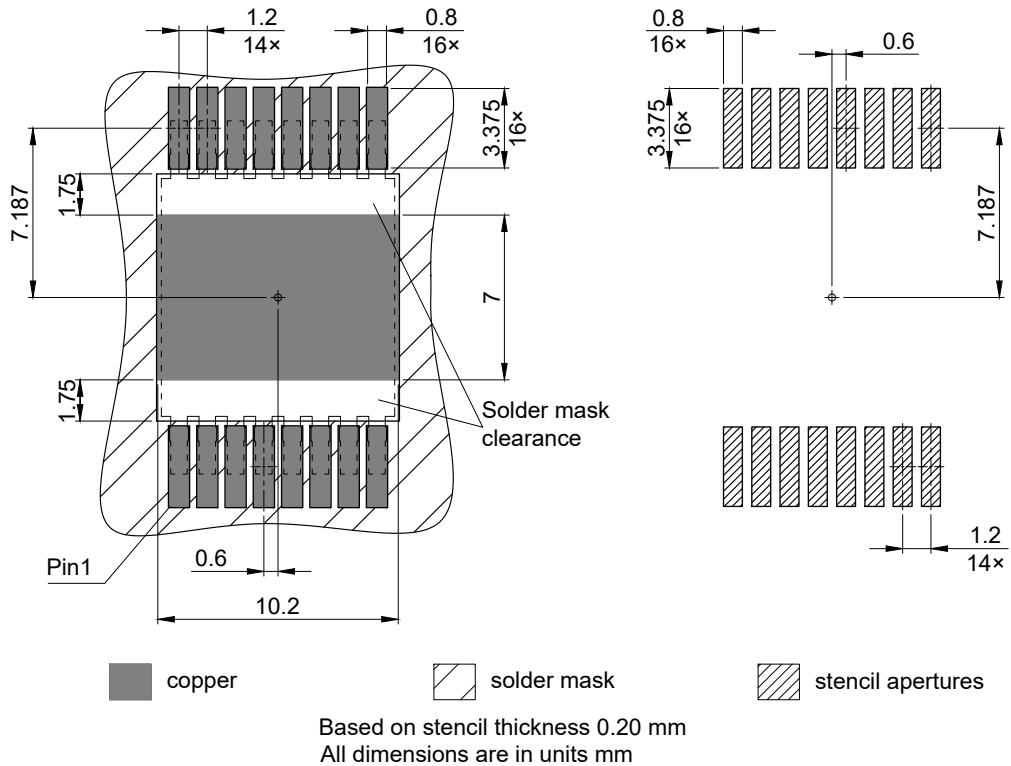
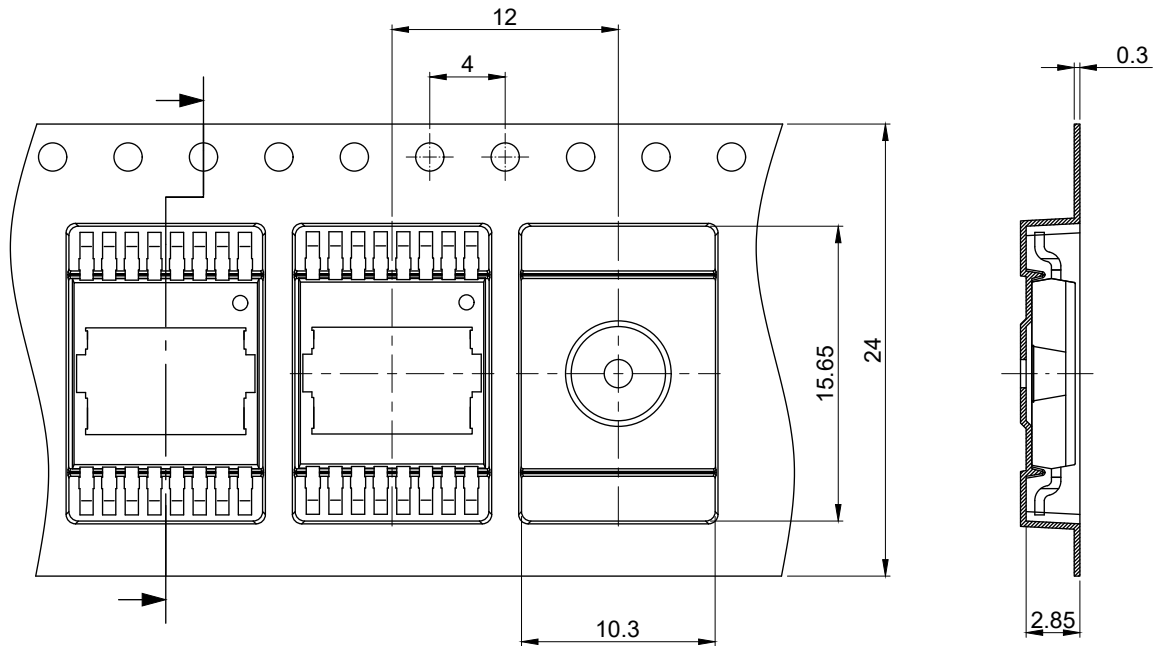

Figure 2 Outline Footprint (PG-HDSOP-16), dimensions in mm

OptiMOS™ 5 Power-Transistor, 100 V

IPTC014N10NM5



All dimensions are in units mm

The drawing is in compliance with ISO 128-30, Projection Method 1 []

Figure 3 Outline Tape (PG-HDSOP-16), dimensions in mm



OptiMOS™ 5 Power-Transistor, 100 V

IPTC014N10NM5

Revision History

IPTC014N10NM5

Revision: 2022-05-24, Rev. 2.0

Previous Revision

Revision	Date	Subjects (major changes since last revision)
2.0	2022-05-24	Release of final version

Trademarks

All referenced product or service names and trademarks are the property of their respective owners.

We Listen to Your Comments

Any information within this document that you feel is wrong, unclear or missing at all? Your feedback will help us to continuously improve the quality of this document. Please send your proposal (including a reference to this document) to:

erratum@infineon.com

Published by

Infineon Technologies AG
81726 München, Germany
© 2022 Infineon Technologies AG
All Rights Reserved.

Legal Disclaimer

The information given in this document shall in no event be regarded as a guarantee of conditions or characteristics ("Beschaffungsgarantie").

With respect to any examples, hints or any typical values stated herein and/or any information regarding the application of the product, Infineon Technologies hereby disclaims any and all warranties and liabilities of any kind, including without limitation warranties of non-infringement of intellectual property rights of any third party.

In addition, any information given in this document is subject to customer's compliance with its obligations stated in this document and any applicable legal requirements, norms and standards concerning customer's products and any use of the product of Infineon Technologies in customer's applications.

The data contained in this document is exclusively intended for technically trained staff. It is the responsibility of customer's technical departments to evaluate the suitability of the product for the intended application and the completeness of the product information given in this document with respect to such application.

Information

For further information on technology, delivery terms and conditions and prices please contact your nearest Infineon Technologies Office (www.infineon.com).

Warnings

Due to technical requirements, components may contain dangerous substances. For information on the types in question, please contact the nearest Infineon Technologies Office.

The Infineon Technologies component described in this Data Sheet may be used in life-support devices or systems and/or automotive, aviation and aerospace applications or systems only with the express written approval of Infineon Technologies, if a failure of such components can reasonably be expected to cause the failure of that life-support, automotive, aviation and aerospace device or system or to affect the safety or effectiveness of that device or system. Life support devices or systems are intended to be implanted in the human body or to support and/or maintain and sustain and/or protect human life. If they fail, it is reasonable to assume that the health of the user or other persons may be endangered.

OUR CERTIFICATE

DiGi provide top-quality products and perfect service for customer worldwide through standardization, technological innovation and continuous improvement. DiGi through third-party certification, we stricly control the quality of products and services. Welcome your RFQ to

Email: Info@DiGi-Electronics.com



Tel: +00 852-30501935

RFQ Email: Info@DiGi-Electronics.com

DiGi is a global authorized distributor of electronic components.