

IRF3717PBF Datasheet



DiGi Electronics Part Number	IRF3717PBF-DG
Manufacturer	Infineon Technologies
Manufacturer Product Number	IRF3717PBF
Description	MOSFET N-CH 20V 20A 8SO
Detailed Description	N-Channel 20 V 20A (Ta) 2.5W (Ta) Surface Mount 8-SO

<https://www.DiGi-Electronics.com>



Tel: +00 852-30501935

RFQ Email: Info@DiGi-Electronics.com

DiGi is a global authorized distributor of electronic components.

Purchase and inquiry

Manufacturer Product Number:

IRF3717PBF

Series:

HEXFET®

FET Type:

N-Channel

Drain to Source Voltage (Vdss):

20 V

Drive Voltage (Max Rds On, Min Rds On):

4.5V, 10V

Vgs(th) (Max) @ Id:

2.45V @ 250µA

Vgs (Max):

±20V

FET Feature:

-

Operating Temperature:

-55°C ~ 150°C (Tj)

Supplier Device Package:

8-SO

Manufacturer:

Infineon Technologies

Product Status:

Discontinued at Digi-Key

Technology:

MOSFET (Metal Oxide)

Current - Continuous Drain (Id) @ 25°C:

20A (Ta)

Rds On (Max) @ Id, Vgs:

4.4mOhm @ 20A, 10V

Gate Charge (Qg) (Max) @ Vgs:

33 nC @ 4.5 V

Input Capacitance (Ciss) (Max) @ Vds:

2890 pF @ 10 V

Power Dissipation (Max):

2.5W (Ta)

Mounting Type:

Surface Mount

Package / Case:

8-SOIC (0.154", 3.90mm Width)

Environmental & Export classification

RoHS Status:

ROHS3 Compliant

REACH Status:

REACH Unaffected

HTSUS:

8541.29.0095

Moisture Sensitivity Level (MSL):

1 (Unlimited)

ECCN:

EAR99

International
IR Rectifier

PD - 95719

IRF3717PbF

HEXFET® Power MOSFET

Applications

- Synchronous MOSFET for Notebook Processor Power
- Synchronous Rectifier MOSFET for Isolated DC-DC Converters in Networking Systems
- Lead-Free

Benefits

- Ultra-Low Gate Impedance
- Very Low $R_{DS(on)}$
- Fully Characterized Avalanche Voltage and Current

V_{DSS}	$R_{DS(on)}$ max	I_D
20V	4.4mΩ@ $V_{GS} = 10V$	20A

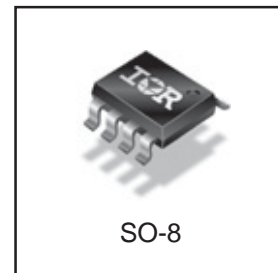
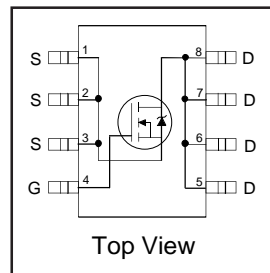

Absolute Maximum Ratings

	Parameter	Max.	Units
V_{DS}	Drain-to-Source Voltage	20	V
V_{GS}	Gate-to-Source Voltage	± 20	
$I_D @ T_A = 25^\circ C$	Continuous Drain Current, $V_{GS} @ 10V$	20	A
$I_D @ T_A = 70^\circ C$	Continuous Drain Current, $V_{GS} @ 10V$	16	
I_{DM}	Pulsed Drain Current ①	160	
$P_D @ T_A = 25^\circ C$	Power Dissipation	2.5	W
$P_D @ T_A = 70^\circ C$	Power Dissipation	1.6	
	Linear Derating Factor	0.02	W/°C
T_J	Operating Junction and	-55 to + 150	°C
T_{STG}	Storage Temperature Range		

Thermal Resistance

	Parameter	Typ.	Max.	Units
$R_{\theta JL}$	Junction-to-Drain Lead	—	20	°C/W
$R_{\theta JA}$	Junction-to-Ambient ④	—	50	

Notes ① through ④ are on page 10

www.irf.com

1
8/10/04

IRF3717PbF

International
IR RectifierStatic @ $T_J = 25^\circ\text{C}$ (unless otherwise specified)

	Parameter	Min.	Typ.	Max.	Units	Conditions
BV_{DSS}	Drain-to-Source Breakdown Voltage	20	—	—	V	$V_{GS} = 0V, I_D = 250\mu A$
$\Delta BV_{DSS}/\Delta T_J$	Breakdown Voltage Temp. Coefficient	—	0.014	—	V/ $^\circ\text{C}$	Reference to $25^\circ\text{C}, I_D = 1\text{mA}$
$R_{DS(on)}$	Static Drain-to-Source On-Resistance	—	3.7	4.4	$\text{m}\Omega$	$V_{GS} = 10V, I_D = 20A$ ③
		—	4.8	5.7		$V_{GS} = 4.5V, I_D = 16A$ ③
$V_{GS(th)}$	Gate Threshold Voltage	1.55	2.0	2.45	V	$V_{DS} = V_{GS}, I_D = 250\mu A$
$\Delta V_{GS(th)}/\Delta T_J$	Gate Threshold Voltage Coefficient	—	-5.4	—	$\text{mV}/^\circ\text{C}$	
I_{DSS}	Drain-to-Source Leakage Current	—	—	1.0	μA	$V_{DS} = 16V, V_{GS} = 0V$
		—	—	150		$V_{DS} = 16V, V_{GS} = 0V, T_J = 125^\circ\text{C}$
I_{GSS}	Gate-to-Source Forward Leakage	—	—	100	nA	$V_{GS} = 20V$
	Gate-to-Source Reverse Leakage	—	—	-100		$V_{GS} = -20V$
gfs	Forward Transconductance	57	—	—	S	$V_{DS} = 10V, I_D = 16A$
Q_g	Total Gate Charge	—	22	33	nC	$V_{DS} = 10V$ $V_{GS} = 4.5V$ $I_D = 16A$ See Fig. 16
Q_{gs1}	Pre-Vth Gate-to-Source Charge	—	6.8	—		
Q_{gs2}	Post-Vth Gate-to-Source Charge	—	2.2	—		
Q_{gd}	Gate-to-Drain Charge	—	7.3	—		
Q_{godr}	Gate Charge Overdrive	—	5.7	—		
Q_{sw}	Switch Charge ($Q_{gs2} + Q_{gd}$)	—	9.5	—	nC	$V_{DS} = 10V, V_{GS} = 0V$
Q_{oss}	Output Charge	—	12	—		
$t_{d(on)}$	Turn-On Delay Time	—	12	—	ns	$V_{DD} = 10V, V_{GS} = 4.5V$ $I_D = 16A$ Clamped Inductive Load
t_r	Rise Time	—	14	—		
$t_{d(off)}$	Turn-Off Delay Time	—	15	—		
t_f	Fall Time	—	6.0	—		
C_{iss}	Input Capacitance	—	2890	—	pF	$V_{GS} = 0V$ $V_{DS} = 10V$ $f = 1.0\text{MHz}$
C_{oss}	Output Capacitance	—	930	—		
C_{riss}	Reverse Transfer Capacitance	—	430	—		

Avalanche Characteristics

	Parameter	Typ.	Max.	Units
E_{AS}	Single Pulse Avalanche Energy ②	—	32	mJ
I_{AR}	Avalanche Current ①	—	16	A

Diode Characteristics

	Parameter	Min.	Typ.	Max.	Units	Conditions
I_S	Continuous Source Current (Body Diode)	—	—	20	A	MOSFET symbol showing the integral reverse p-n junction diode.
I_{SM}	Pulsed Source Current (Body Diode) ①	—	—	160		
V_{SD}	Diode Forward Voltage	—	—	1.0	V	$T_J = 25^\circ\text{C}, I_S = 16A, V_{GS} = 0V$ ③
t_{rr}	Reverse Recovery Time	—	22	32	ns	$T_J = 25^\circ\text{C}, I_F = 16A, V_{DD} = 10V$
Q_{rr}	Reverse Recovery Charge	—	13	19	nC	$di/dt = 100A/\mu s$ ③

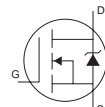

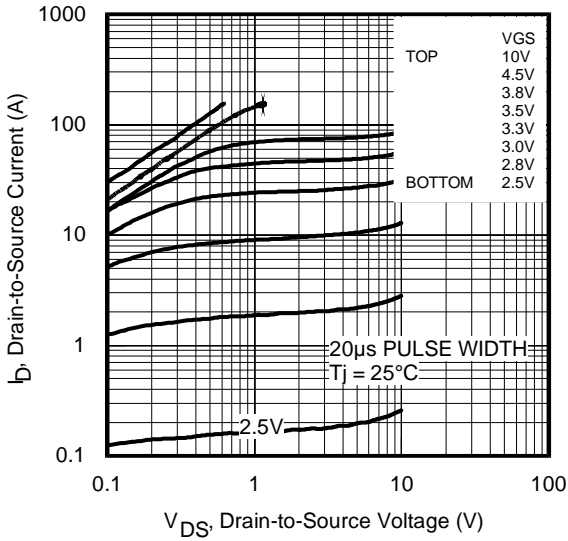

Fig 1. Typical Output Characteristics

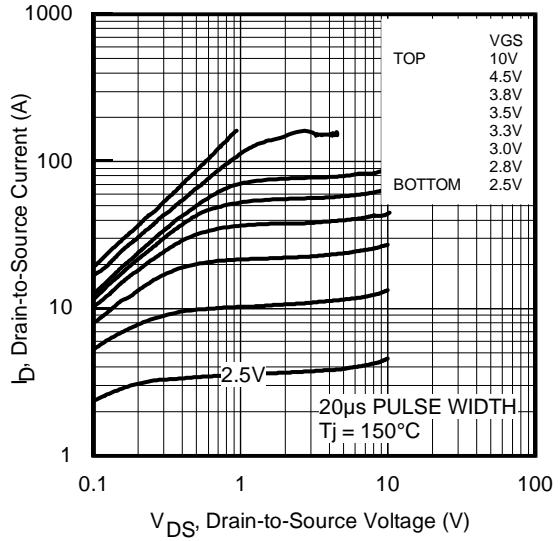

Fig 2. Typical Output Characteristics

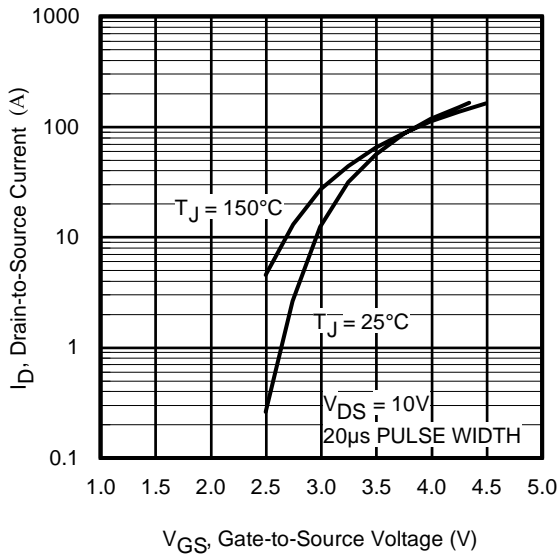

Fig 3. Typical Transfer Characteristics

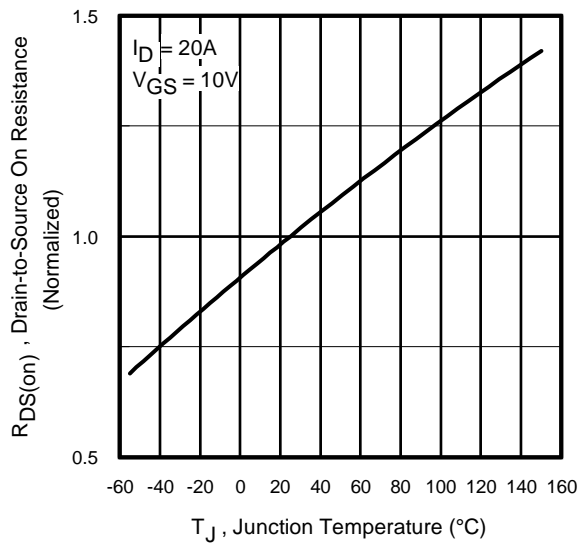

Fig 4. Normalized On-Resistance vs. Temperature

IRF3717PbF

International
IR Rectifier

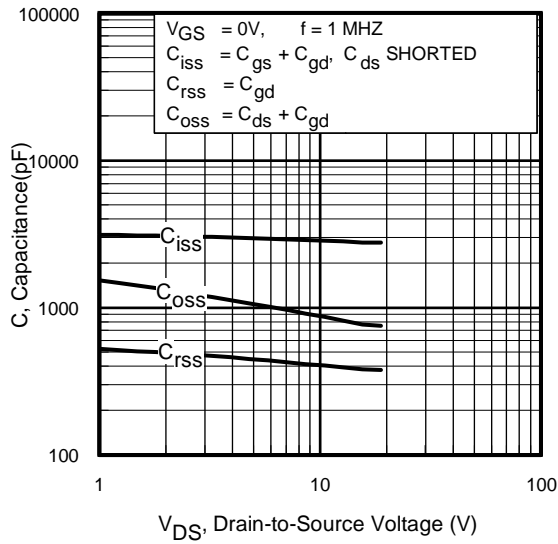

Fig 5. Typical Capacitance vs. Drain-to-Source Voltage

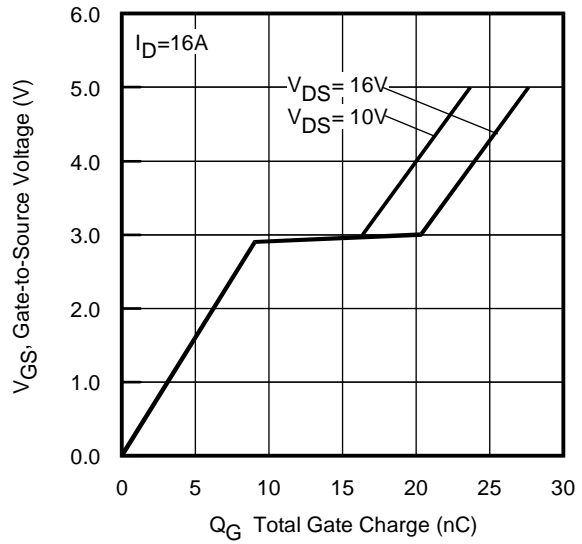

Fig 6. Typical Gate Charge Vs. Gate-to-Source Voltage

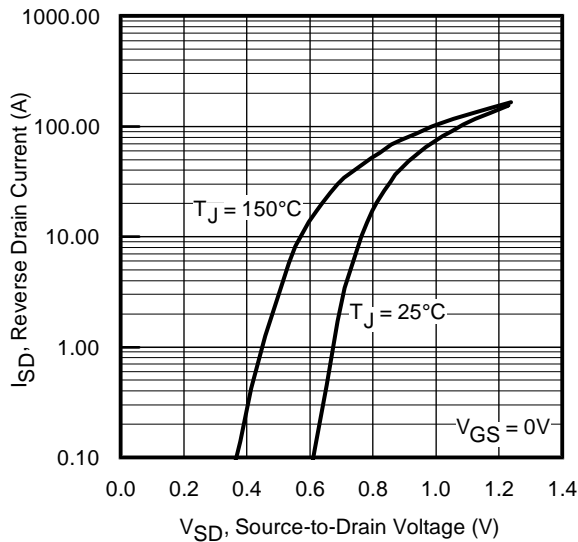

Fig 7. Typical Source-Drain Diode Forward Voltage

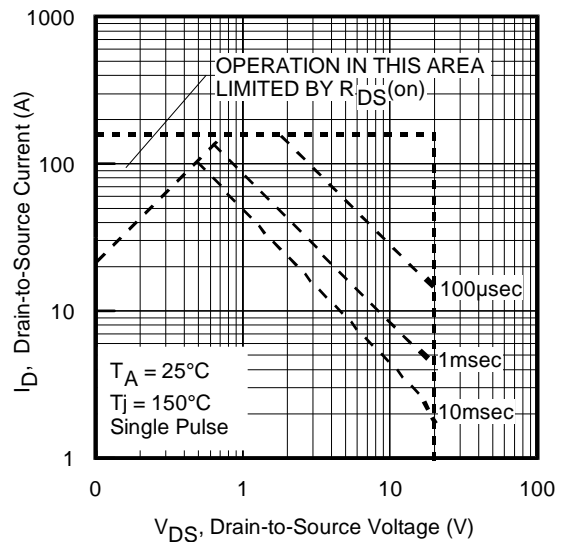

Fig 8. Maximum Safe Operating Area

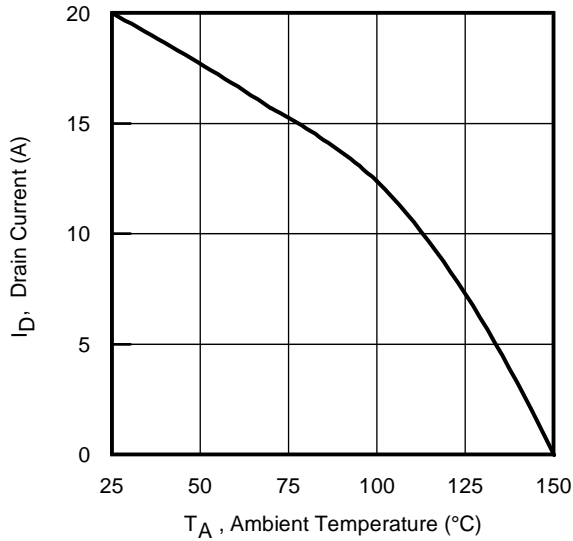

Fig 9. Maximum Drain Current vs. Ambient Temperature

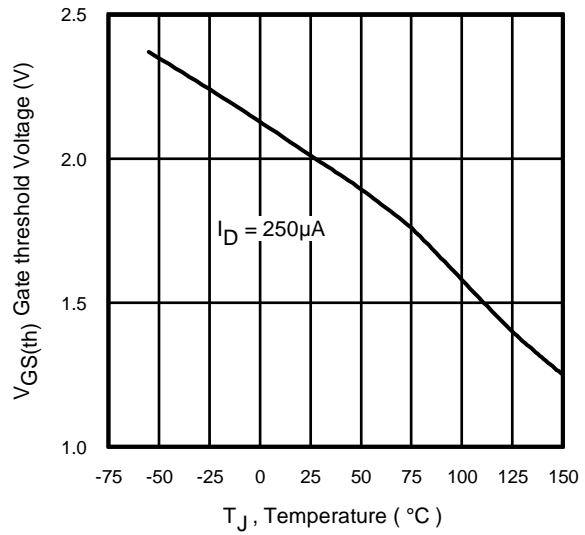

Fig 10. Threshold Voltage vs. Temperature

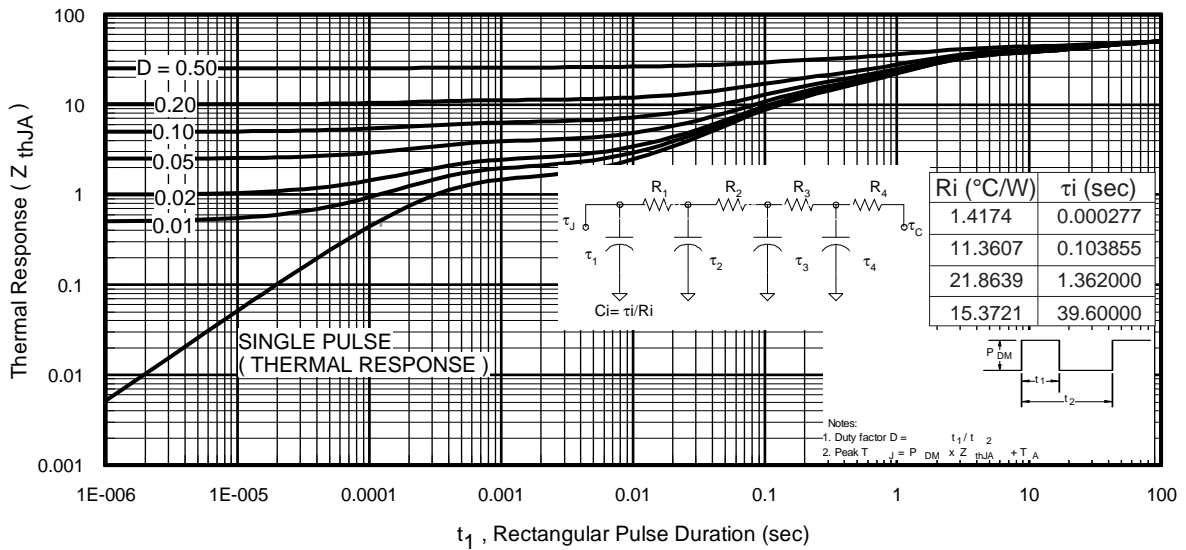

Fig 11. Maximum Effective Transient Thermal Impedance, Junction-to-Ambient

IRF3717PbF

International
IR Rectifier

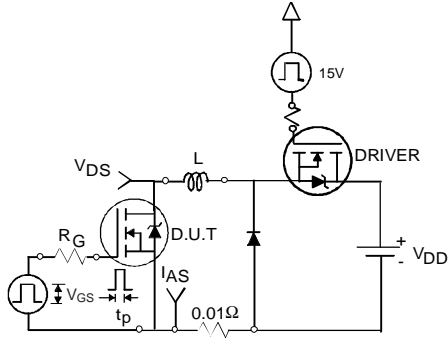

Fig 12a. Unclamped Inductive Test Circuit

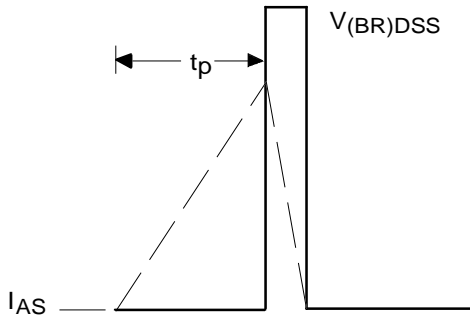

Fig 12b. Unclamped Inductive Waveforms

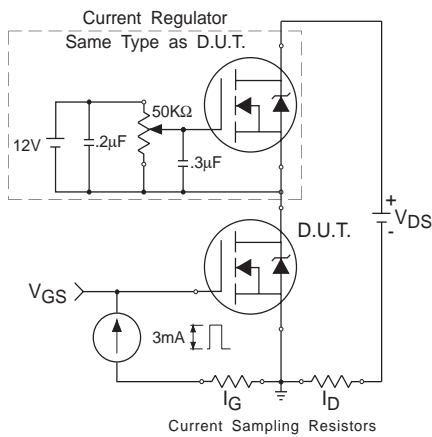

Fig 13. Gate Charge Test Circuit

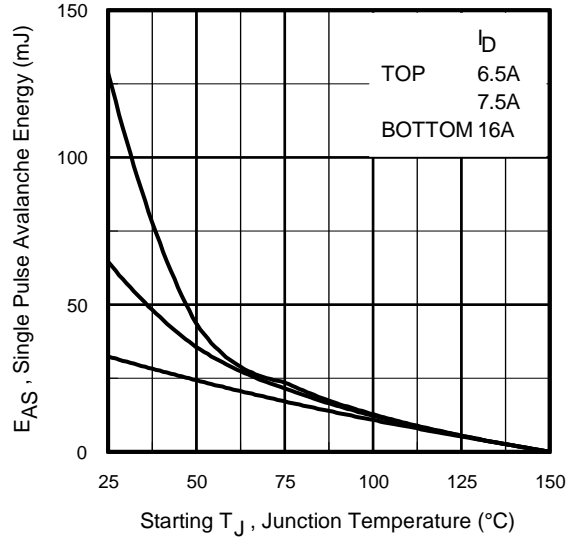

Fig 12c. Maximum Avalanche Energy vs. Drain Current

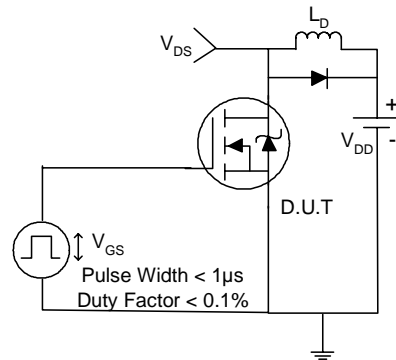

Fig 14a. Switching Time Test Circuit

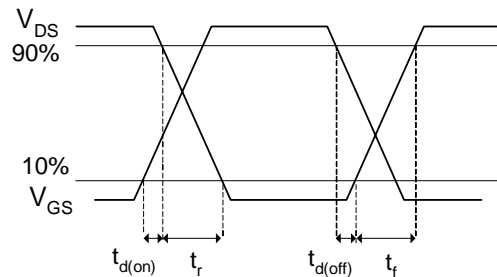

Fig 14b. Switching Time Waveforms

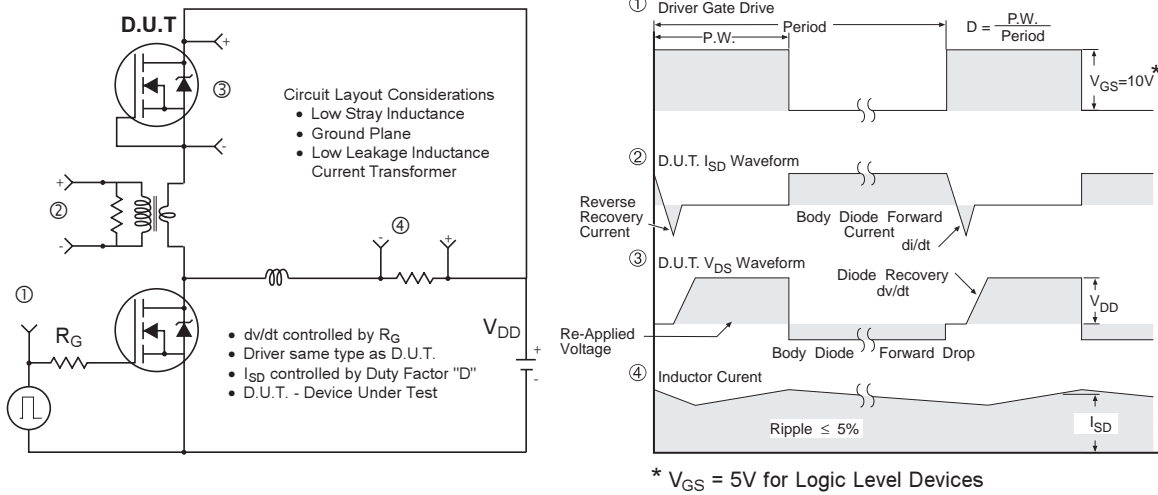

Fig 15. Peak Diode Recovery dv/dt Test Circuit for N-Channel HEXFET® Power MOSFETs

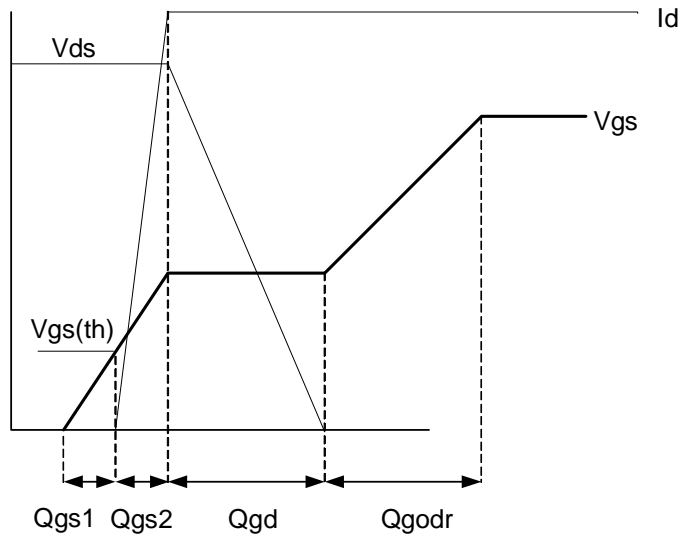

Fig 16. Gate Charge Waveform

IRF3717PbF

International
IR Rectifier

Power MOSFET Selection for Non-Isolated DC/DC Converters

Control FET

Special attention has been given to the power losses in the switching elements of the circuit - Q1 and Q2. Power losses in the high side switch Q1, also called the Control FET, are impacted by the $R_{ds(on)}$ of the MOSFET, but these conduction losses are only about one half of the total losses.

Power losses in the control switch Q1 are given by;

$$P_{loss} = P_{conduction} + P_{switching} + P_{drive} + P_{output}$$

This can be expanded and approximated by;

$$P_{loss} = (I_{rms}^2 \times R_{ds(on)}) + \left(I \times \frac{Q_{gd}}{i_g} \times V_{in} \times f \right) + \left(I \times \frac{Q_{gs2}}{i_g} \times V_{in} \times f \right) + (Q_g \times V_g \times f) + \left(\frac{Q_{oss}}{2} \times V_{in} \times f \right)$$

This simplified loss equation includes the terms Q_{gs2} and Q_{oss} which are new to Power MOSFET data sheets.

Q_{gs2} is a sub element of traditional gate-source charge that is included in all MOSFET data sheets. The importance of splitting this gate-source charge into two sub elements, Q_{gs1} and Q_{gs2} , can be seen from Fig 16.

Q_{gs2} indicates the charge that must be supplied by the gate driver between the time that the threshold voltage has been reached and the time the drain current rises to I_{dmax} at which time the drain voltage begins to change. Minimizing Q_{gs2} is a critical factor in reducing switching losses in Q1.

Q_{oss} is the charge that must be supplied to the output capacitance of the MOSFET during every switching cycle. Figure A shows how Q_{oss} is formed by the parallel combination of the voltage dependant (non-linear) capacitance's C_{ds} and C_{dg} when multiplied by the power supply input buss voltage.

Synchronous FET

The power loss equation for Q2 is approximated by;

$$P_{loss} = P_{conduction} + P_{drive} + P_{output}^*$$

$$P_{loss} = (I_{rms}^2 \times R_{ds(on)}) + (Q_g \times V_g \times f) + \left(\frac{Q_{oss}}{2} \times V_{in} \times f \right) + (Q_{rr} \times V_{in} \times f)$$

*dissipated primarily in Q1.

For the synchronous MOSFET Q2, $R_{ds(on)}$ is an important characteristic; however, once again the importance of gate charge must not be overlooked since it impacts three critical areas. Under light load the MOSFET must still be turned on and off by the control IC so the gate drive losses become much more significant. Secondly, the output charge Q_{oss} and reverse recovery charge Q_{rr} both generate losses that are transferred to Q1 and increase the dissipation in that device. Thirdly, gate charge will impact the MOSFETs' susceptibility to Cdv/dt turn on.

The drain of Q2 is connected to the switching node of the converter and therefore sees transitions between ground and V_{in} . As Q1 turns on and off there is a rate of change of drain voltage dV/dt which is capacitively coupled to the gate of Q2 and can induce a voltage spike on the gate that is sufficient to turn the MOSFET on, resulting in shoot-through current. The ratio of Q_{gd}/Q_{gs1} must be minimized to reduce the potential for Cdv/dt turn on.

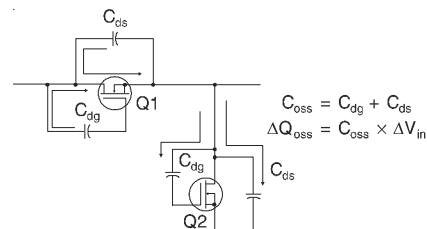

Figure A: Q_{oss} Characteristic

International
IR Rectifier

IRF3717PbF

SO-8 Package Outline

Dimensions are shown in millimeters (inches)

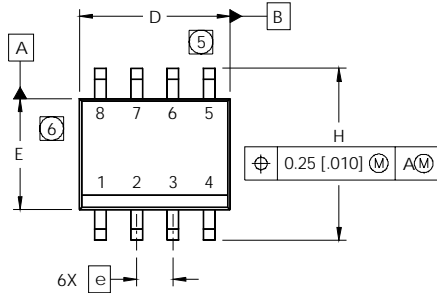

DIM	INCHES		MILLIMETERS	
	MIN	MAX	MIN	MAX
A	.0532	.0688	1.35	1.75
A1	.0040	.0098	0.10	0.25
b	.013	.020	0.33	0.51
c	.0075	.0098	0.19	0.25
D	.189	.1968	4.80	5.00
E	.1497	.1574	3.80	4.00
e	.050 BASIC		1.27 BASIC	
e1	.025 BASIC		0.635 BASIC	
H	.2284	.2440	5.80	6.20
K	.0099	.0196	0.25	0.50
L	.016	.050	0.40	1.27
y	0°	8°	0°	8°

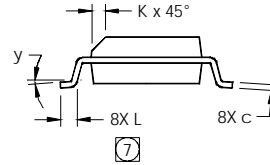
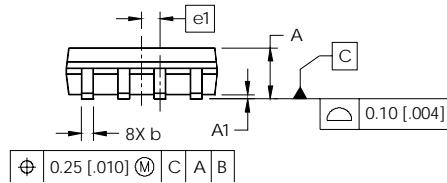

NOTES:

1. DIMENSIONING & TOLERANCING PER ASME Y14.5M-1994.
2. CONTROLLING DIMENSION: MILLIMETER
3. DIMENSIONS ARE SHOWN IN MILLIMETERS [INCHES].
4. OUTLINE CONFORMS TO JEDEC OUTLINE MS-012AA
- ⑤ DIMENSION DOES NOT INCLUDE MOLD PROTRUSIONS. MOLD PROTRUSIONS NOT TO EXCEED 0.15 [0.006].
- ⑥ DIMENSION DOES NOT INCLUDE MOLD PROTRUSIONS. MOLD PROTRUSIONS NOT TO EXCEED 0.25 [0.010].
- ⑦ DIMENSION IS THE LENGTH OF LEAD FOR SOLDERING TO A SUBSTRATE.

FOOTPRINT

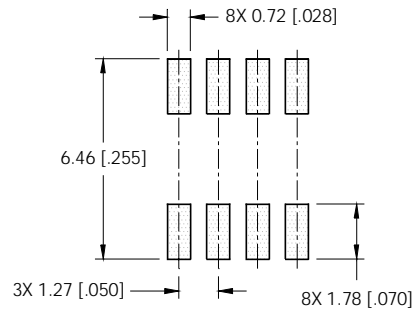

SO-8 Part Marking

EXAMPLE: THIS IS AN IRF7101 (MOSFET)

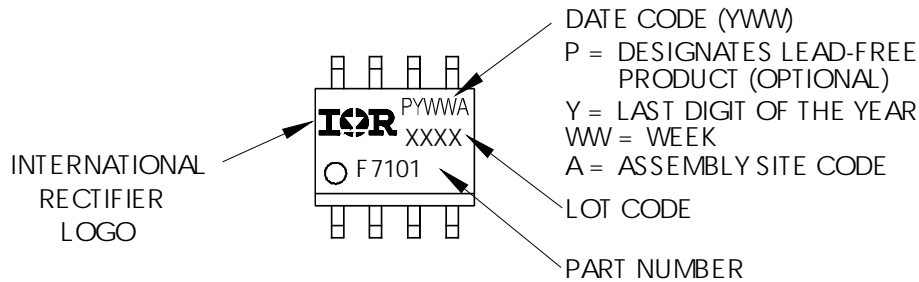

IRF3717PbF

SO-8 Tape and Reel

Dimensions are shown in millimeters (inches)

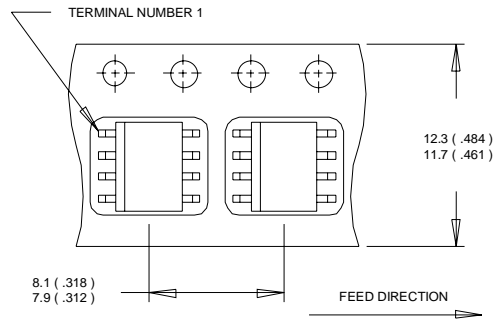

- NOTES:
1. CONTROLLING DIMENSION : MILLIMETER.
 2. ALL DIMENSIONS ARE SHOWN IN MILLIMETERS(INCHES).
 3. OUTLINE CONFORMS TO EIA-481 & EIA-541.

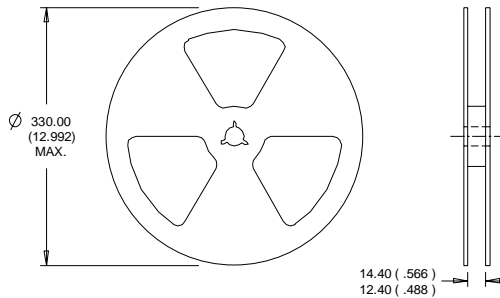

- NOTES:
1. CONTROLLING DIMENSION : MILLIMETER.
 2. OUTLINE CONFORMS TO EIA-481 & EIA-541.

Notes:

- ① Repetitive rating; pulse width limited by max. junction temperature.
- ② Starting $T_J = 25^\circ\text{C}$, $L = 0.26\text{mH}$, $R_G = 25\Omega$, $I_{AS} = 16\text{A}$.
- ③ Pulse width $\leq 400\mu\text{s}$; duty cycle $\leq 2\%$.
- ④ When mounted on 1 inch square copper board.

Data and specifications subject to change without notice.
 This product has been designed and qualified for the Consumer market.
 Qualifications Standards can be found on IR's Web site.



IR WORLD HEADQUARTERS: 233 Kansas St., El Segundo, California 90245, USA Tel: (310) 252-7105
 TAC Fax: (310) 252-7903

Visit us at www.irf.com for sales contact information.08/04

www.irf.com

OUR CERTIFICATE

DiGi provide top-quality products and perfect service for customer worldwide through standardization, technological innovation and continuous improvement. DiGi through third-party certification, we stricly control the quality of products and services. Welcome your RFQ to

Email: Info@DiGi-Electronics.com



Tel: +00 852-30501935

RFQ Email: Info@DiGi-Electronics.com

DiGi is a global authorized distributor of electronic components.