

IRF5803TR Datasheet

www.digi-electronics.com

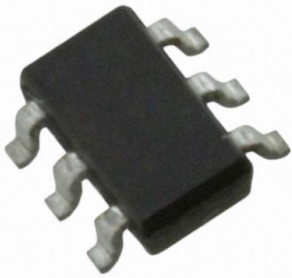

<https://www.DiGi-Electronics.com>

DiGi Electronics Part Number	IRF5803TR-DG
Manufacturer	Infineon Technologies
Manufacturer Product Number	IRF5803TR
Description	MOSFET P-CH 40V 3.4A MICRO6
Detailed Description	P-Channel 40 V 3.4A (Ta) 2W (Ta) Surface Mount Micro6™(TSOP-6)



Tel: +00 852-30501935

RFQ Email: Info@DiGi-Electronics.com

DiGi is a global authorized distributor of electronic components.

Purchase and inquiry

Manufacturer Product Number:

IRF5803TR

Series:

HEXFET®

FET Type:

P-Channel

Drain to Source Voltage (Vdss):

40 V

Drive Voltage (Max Rds On, Min Rds On):

4.5V, 10V

Vgs(th) (Max) @ Id:

3V @ 250µA

Vgs (Max):

±20V

FET Feature:

-

Operating Temperature:

-55°C ~ 150°C (Tj)

Supplier Device Package:

Micro6™(TSOP-6)

Manufacturer:

Infineon Technologies

Product Status:

Obsolete

Technology:

MOSFET (Metal Oxide)

Current - Continuous Drain (Id) @ 25°C:

3.4A (Ta)

Rds On (Max) @ Id, Vgs:

112mOhm @ 3.4A, 10V

Gate Charge (Qg) (Max) @ Vgs:

37 nC @ 10 V

Input Capacitance (Ciss) (Max) @ Vds:

1110 pF @ 25 V

Power Dissipation (Max):

2W (Ta)

Mounting Type:

Surface Mount

Package / Case:

SOT-23-6 Thin, TSOT-23-6

Environmental & Export classification

RoHS Status:

RoHS non-compliant

REACH Status:

REACH Unaffected

HTSUS:

8541.29.0095

Moisture Sensitivity Level (MSL):

1 (Unlimited)

ECCN:

EAR99

- Ultra Low On-Resistance
- P-Channel MOSFET
- Surface Mount
- Available in Tape & Reel
- Low Gate Charge
- Lead-Free
- Halogen-Free

HEXFET® Power MOSFET

V_{DS}	$R_{DS(on)}$ (max)	I_D
- 40V	112mΩ @ $V_{GS} = -10V$	-3.4A
	190mΩ @ $V_{GS} = -4.5V$	-2.7A

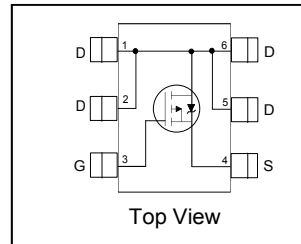

G	D	S
Gate	Drain	Source

Description

These P-channel HEXFET® Power MOSFETs from International Rectifier utilize advanced processing techniques to achieve the extremely low on-resistance per silicon area. This benefit provides the designer with an extremely efficient device for use in battery and load management applications.

The TSOP-6 package with its customized lead frame produces a HEXFET® power MOSFET with $R_{DS(on)}$ 60% less than a similar size SOT-23. This package is ideal for applications where printed circuit board space is at a premium. It's unique thermal design and $R_{DS(on)}$ reduction enables a current-handling increase of nearly 300% compared to the SOT-23.

Base part number	Package Type	Standard Pack		Orderable Part Number
		Form	Quantity	
IRF5803PbF	TSOP-6	Tape and Reel	3000	IRF5803TRPbF

Absolute Maximum Ratings

Symbol	Parameter	Max.	Units
V_{DS}	Drain-to-Source Voltage	-40	V
$I_D @ T_A = 25^\circ C$	Continuous Drain Current, $V_{GS} @ -10V$	- 3.4	A
$I_D @ T_A = 70^\circ C$	Continuous Drain Current, $V_{GS} @ -10V$	-2.7	
I_{DM}	Pulsed Drain Current ①	- 27	
$P_D @ T_A = 25^\circ C$	Maximum Power Dissipation ③	2.0	W
$P_D @ T_A = 70^\circ C$	Maximum Power Dissipation ③	1.3	
	Linear Derating Factor	16	mW/°C
V_{GS}	Gate-to-Source Voltage	± 20	
T_J	Operating Junction and	-55 to + 150	°C
T_{STG}	Storage Temperature Range		

Thermal Resistance

Symbol	Parameter	Typ.	Max.	Units
$R_{\theta JA}$	Junction-to-Ambient ③	—	62.5	°C/W

Electrical Characteristics @ $T_J = 25^\circ\text{C}$ (unless otherwise specified)

	Parameter	Min.	Typ.	Max.	Units	Conditions
$V_{(BR)DSS}$	Drain-to-Source Breakdown Voltage	-40	—	—	V	$V_{GS} = 0V, I_D = -250\mu A$
$\Delta V_{(BR)DSS}/\Delta T_J$	Breakdown Voltage Temp. Coefficient	—	-0.03	—	V/ $^\circ\text{C}$	Reference to 25°C , $I_D = -1\text{mA}$
$R_{DS(on)}$	Static Drain-to-Source On-Resistance	—	—	112	m Ω	$V_{GS} = -10V, I_D = -3.4A$
		—	—	190		$V_{GS} = -4.5V, I_D = -2.7A$
$V_{GS(th)}$	Gate Threshold Voltage	-1.0	—	-3.0	V	$V_{DS} = V_{GS}, I_D = -250\mu A$
g_{fs}	Forward Trans conductance	4.0	—	—	S	$V_{DS} = -10V, I_D = -3.4A$
I_{DSS}	Drain-to-Source Leakage Current	—	—	-10	μA	$V_{DS} = -32V, V_{GS} = 0V$
		—	—	-25		$V_{DS} = -32V, V_{GS} = 0V, T_J = 150^\circ\text{C}$
I_{GSS}	Gate-to-Source Forward Leakage	—	—	-100	nA	$V_{GS} = -20V$
	Gate-to-Source Reverse Leakage	—	—	100		$V_{GS} = 20V$
Q_g	Total Gate Charge	—	25	37	nC	$I_D = -3.4A$
Q_{gs}	Gate-to-Source Charge	—	4.5	6.8		$V_{DS} = -20V$
Q_{gd}	Gate-to-Drain ('Miller') Charge	—	3.5	5.3		$V_{GS} = -10V$
$t_{d(on)}$	Turn-On Delay Time	—	43	—	ns	$V_{DD} = -20V$ ②
t_r	Rise Time	—	550	—		$I_D = -1.0A$
$t_{d(off)}$	Turn-Off Delay Time	—	88	—		$R_G = 6.0\Omega$
t_f	Fall Time	—	50	—		$V_{GS} = -10V$
C_{iss}	Input Capacitance	—	1110	—	pF	$V_{GS} = 0V$
C_{oss}	Output Capacitance	—	93	—		$V_{DS} = -25V$
C_{rss}	Reverse Transfer Capacitance	—	73	—		$f = 100\text{KHz}$

Source-Drain Ratings and Characteristics

	Parameter	Min.	Typ.	Max.	Units	Conditions
I_S	Continuous Source Current (Body Diode)	—	—	-2.0	A	MOSFET symbol showing the integral reverse p-n junction diode. 
I_{SM}	Pulsed Source Current (Body Diode) ①	—	—	-27		
V_{SD}	Diode Forward Voltage	—	—	-1.2	V	$T_J = 25^\circ\text{C}, I_S = -2.0A, V_{GS} = 0V$ ②
t_{rr}	Reverse Recovery Time	—	27	40	ns	$T_J = 25^\circ\text{C}, I_F = -2.0A$
Q_{rr}	Reverse Recovery Charge	—	34	50	nC	$di/dt = 100A/\mu s$ ②

Notes:

- ① Repetitive rating; pulse width limited by max. junction temperature.
- ② Pulse width $\leq 400\mu s$; duty cycle $\leq 2\%$.
- ③ Surface mounted on 1 in square Cu board

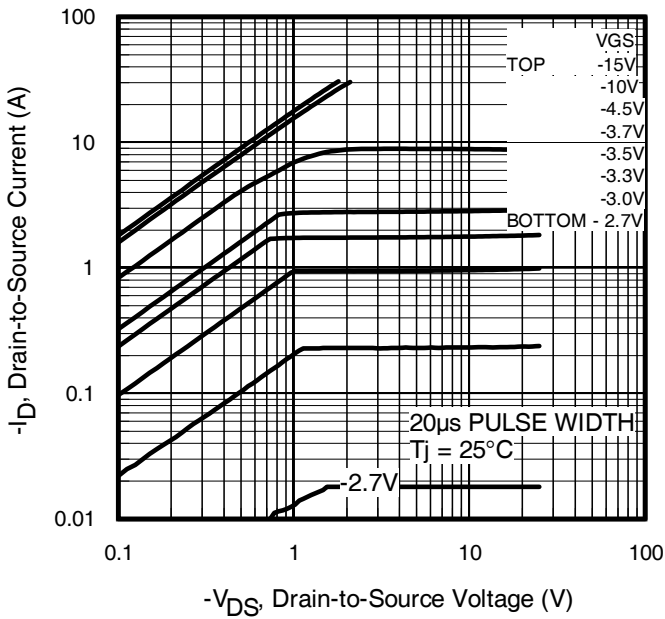
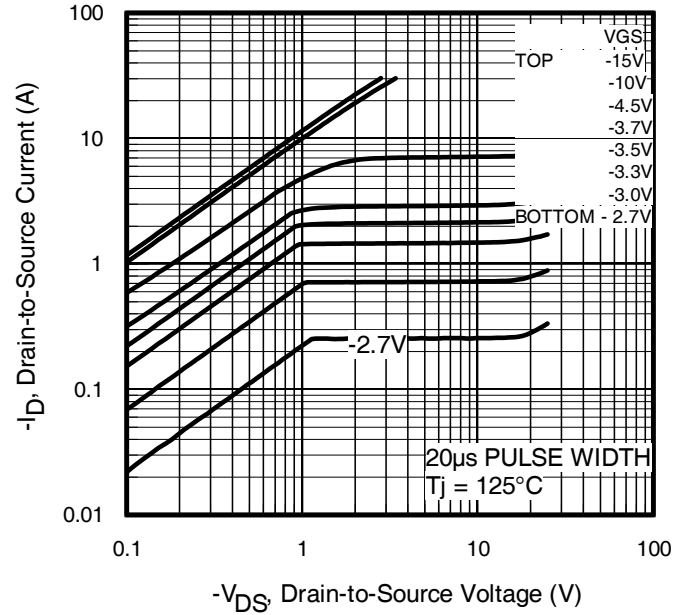
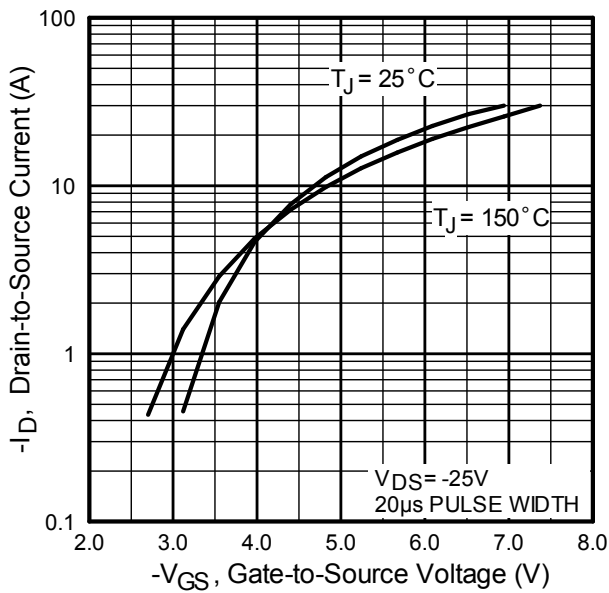
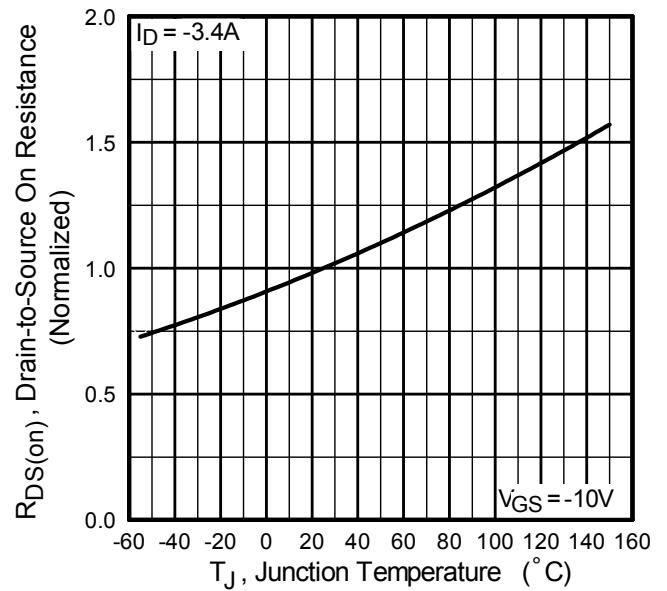
Fig. 1 Typical Output Characteristics

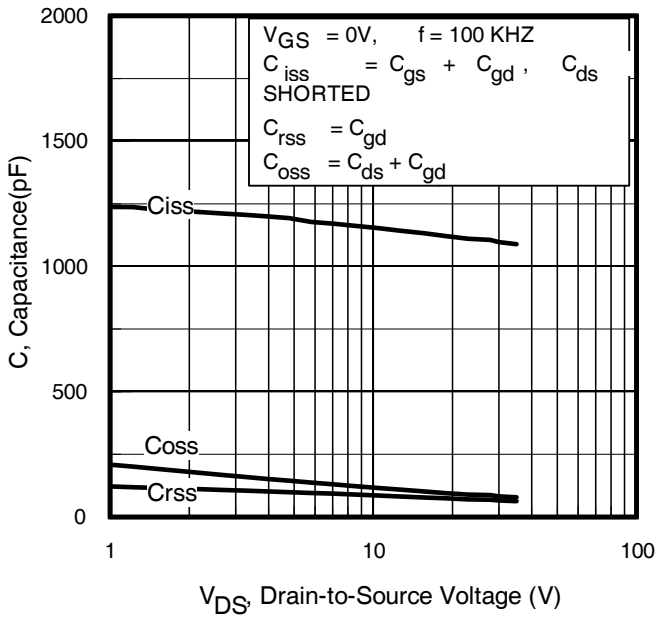
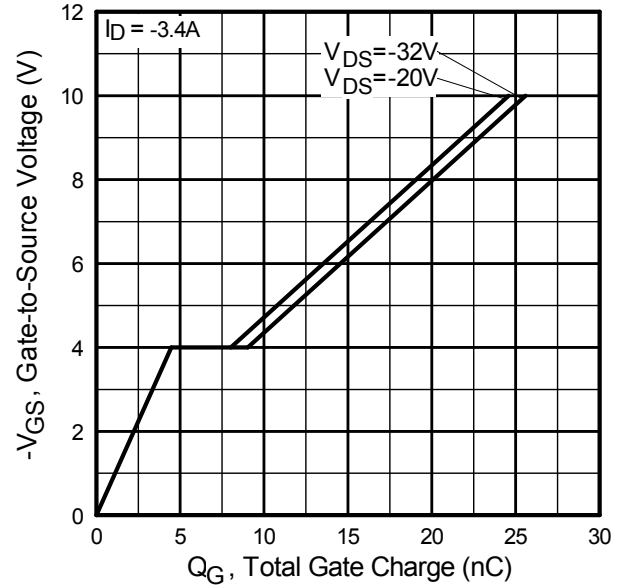
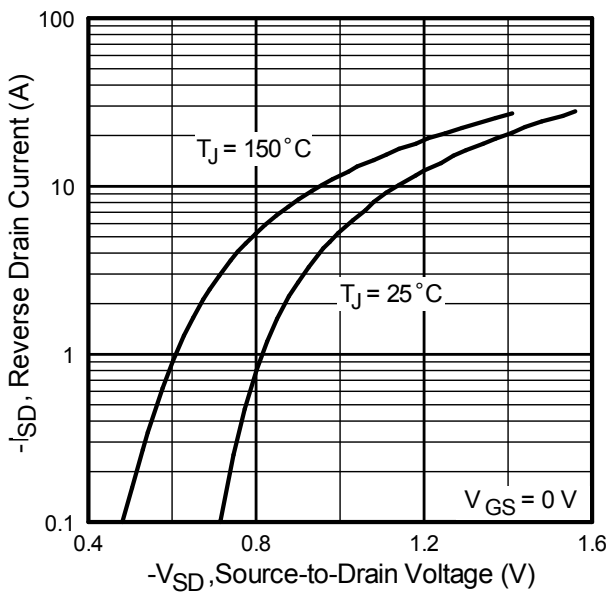
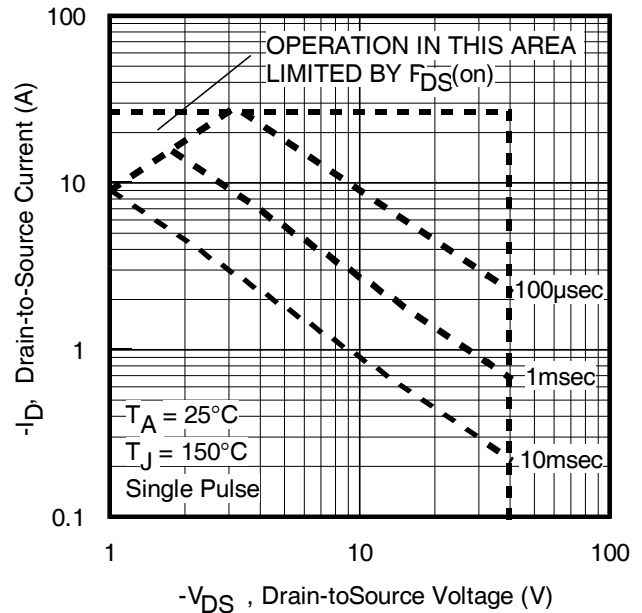
Fig. 2 Typical Output Characteristics

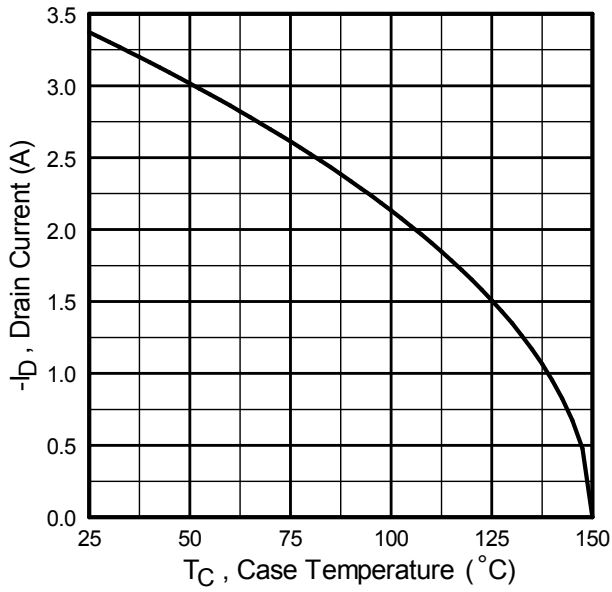
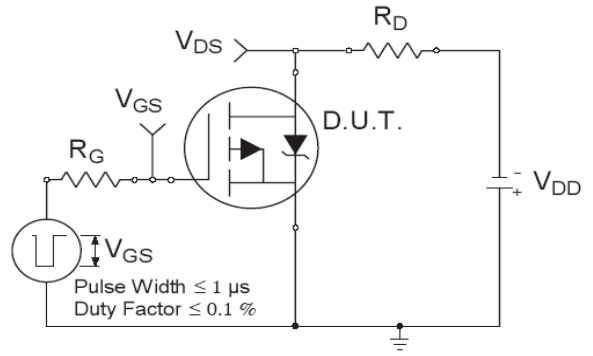
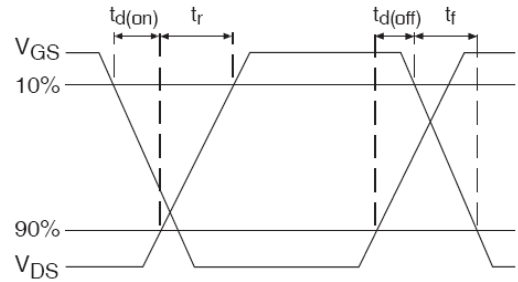
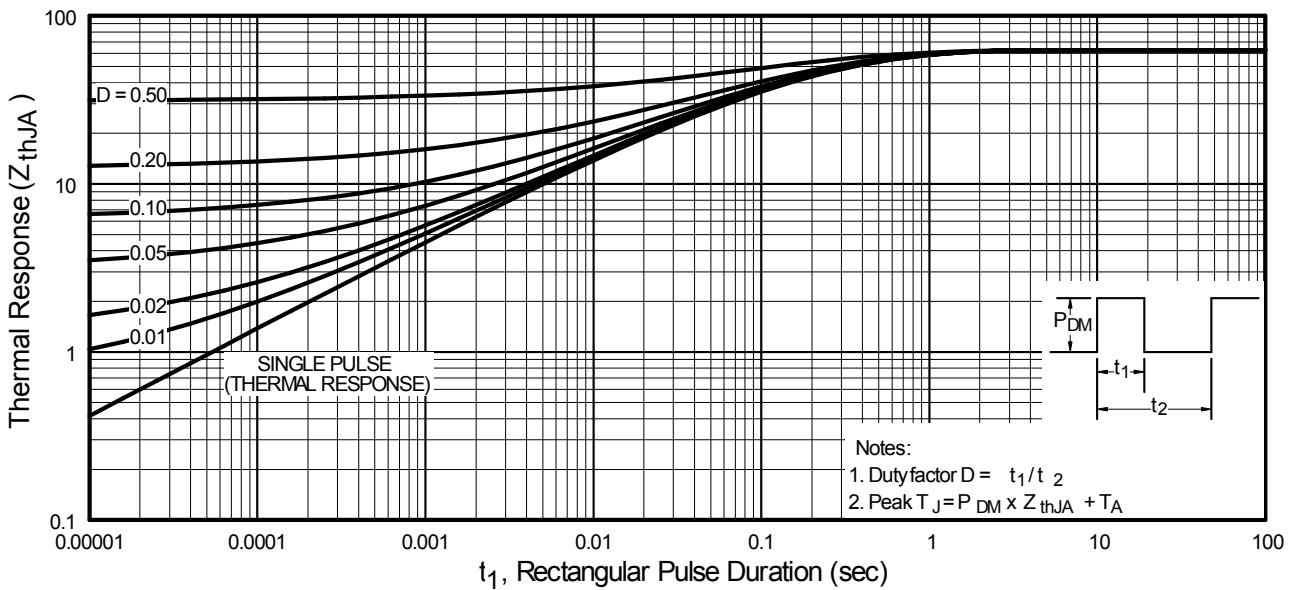
Fig. 3 Typical Transfer Characteristics

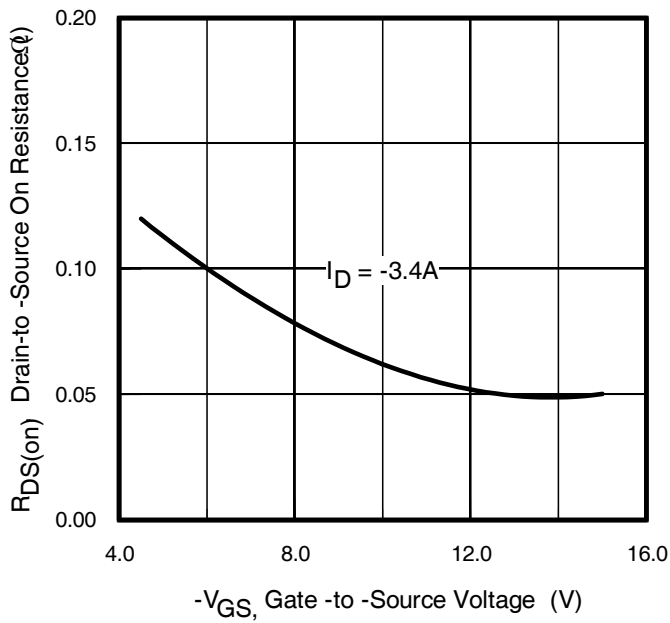
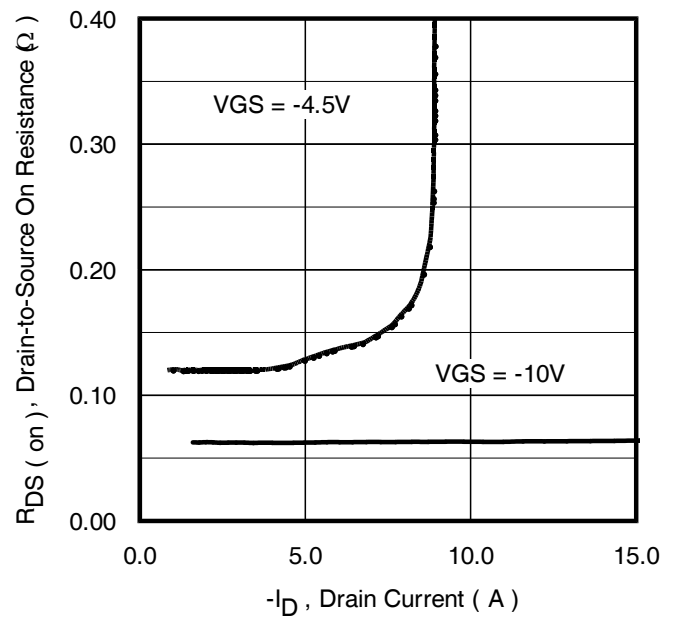
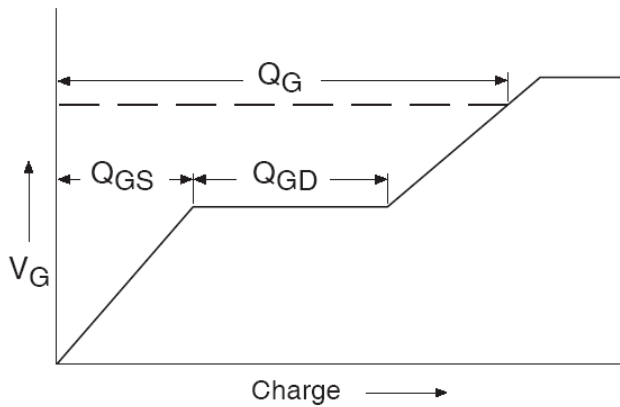
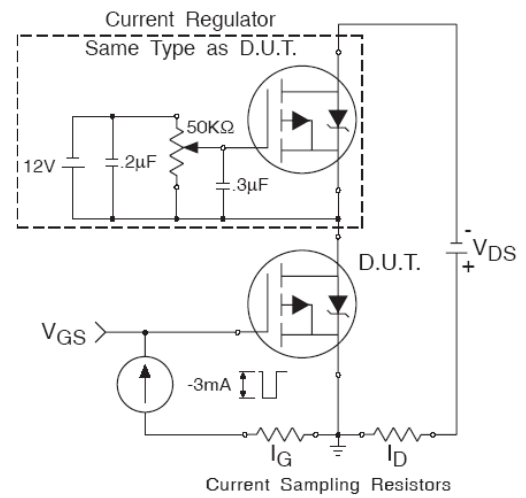
Fig. 4 Normalized On-Resistance vs. Temperature

Fig 5. Typical Capacitance vs. Drain-to-Source Voltage

Fig 6. Typical Gate Charge vs. Gate-to-Source Voltage

Fig. 7 Typical Source-to-Drain Diode Forward Voltage

Fig 8. Maximum Safe Operating Area

Fig 9. Maximum Drain Current vs. Case Temperature

Fig 10a. Switching Time Test Circuit

Fig 10b. Switching Time Waveforms

Fig 11. Maximum Effective Transient Thermal Impedance, Junction-to-Ambient

Fig 12. Typical On-Resistance Vs. Gate Voltage

Fig 13. Typical On-Resistance Vs. Drain Current

Fig 14a. Basic Gate Charge Waveform

Fig 14b. Gate Charge Test Circuit

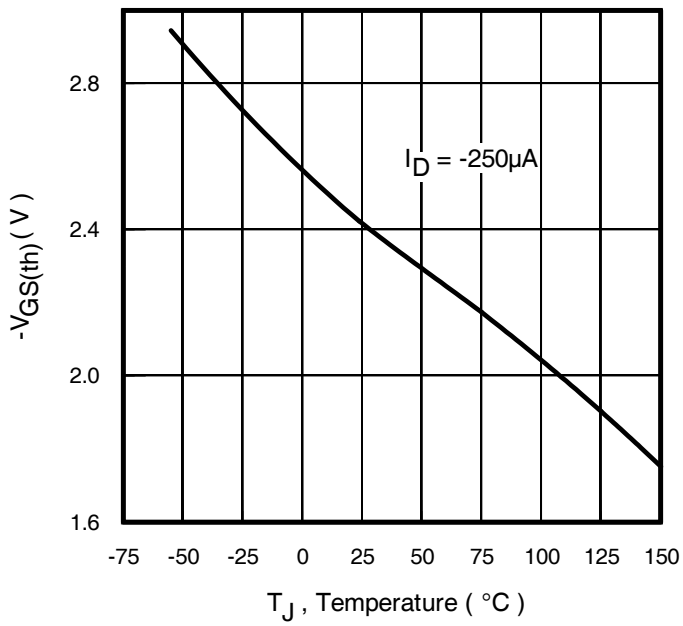

Fig 15. Typical Threshold Voltage Vs. Junction Temperature

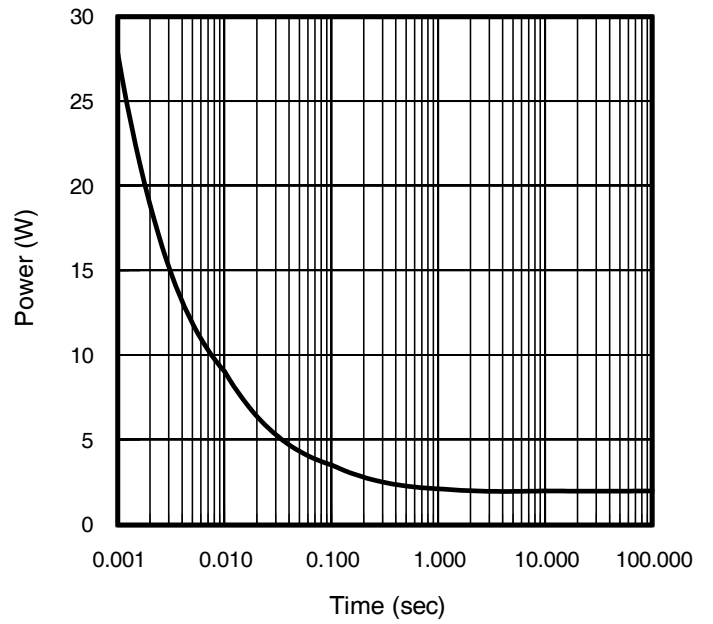
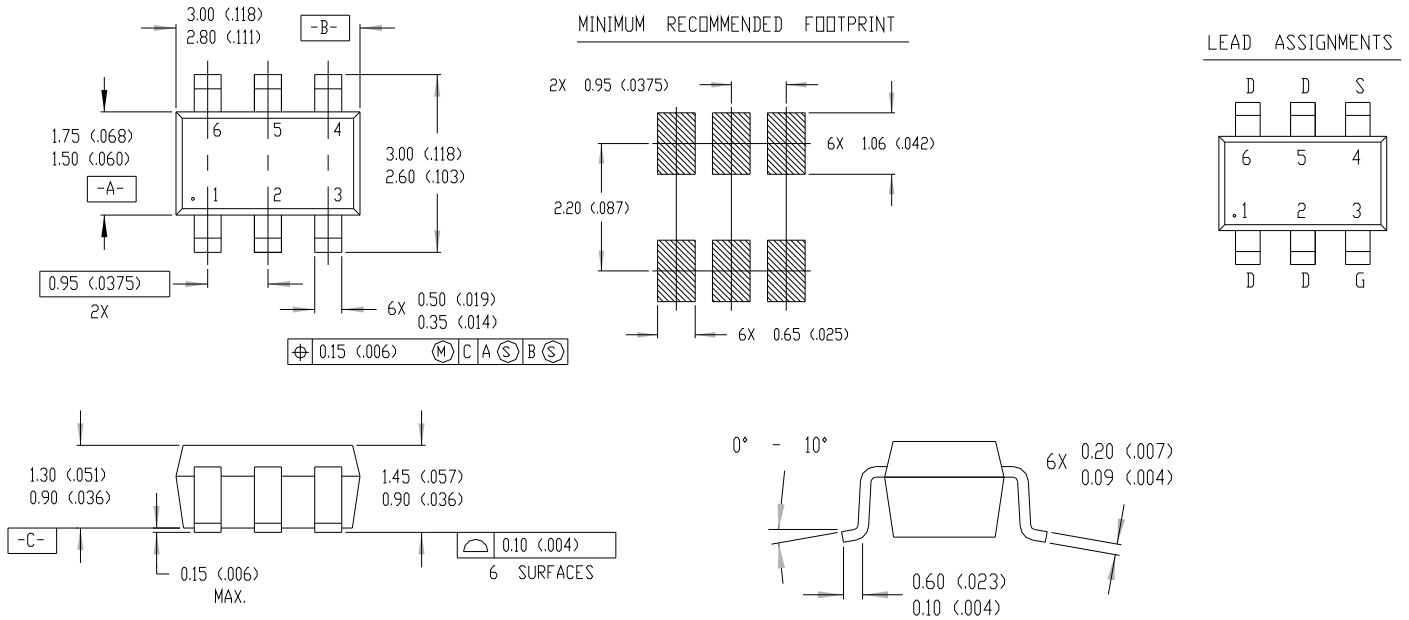
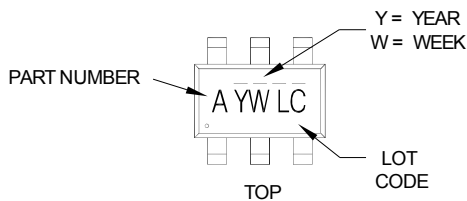

Fig 16. Typical Power Vs. Time

TSOP-6 Package Outline

TSOP-6 Part Marking Information

PART NUMBER CODE REFERENCE:

A = SI3443DV	O = IRLTS6342TRPBF
B = IRF5800	P = IRF58342TRPBF
C = IRF5850	R = IRF589342TRPBF
D = IRF5851	S = Not applicable
E = IRF5852	T = IRLTS2242TRPBF
F = IRF5801	
G = IRF5803	
H = IRF5804	
I = IRF5805	
J = IRF5806	
K = IRF5810	
N = IRF5802	

Note: A line above the work week (as shown here) indicates Lead-Free.

DATE CODE MARKING INSTRUCTIONS

WW = (1-26) IF PRECEDED BY LAST DIGIT OF CALENDAR YEAR

YEAR	Y	WORK WEEK	W	
2011	2001	1	01	A
2012	2002	2	02	B
2013	2003	3	03	C
2014	2004	4	04	D
2015	2005	5		
2016	2006	6		
2017	2007	7		
2018	2008	8		
2019	2009	9		
2020	2010	0	24	X
			25	Y
			26	Z

WW = (27-52) IF PRECEDED BY A LETTER

YEAR	Y	WORK WEEK	W	
2011	2001	A	27	A
2012	2002	B	28	B
2013	2003	C	29	C
2014	2004	D	30	D
2015	2005	E		
2016	2006	F		
2017	2007	G		
2018	2008	H		
2019	2009	J		
2020	2010	K	50	X
			51	Y
			52	Z

Note: For the most current drawing please refer to Infineon's web site www.infineon.com

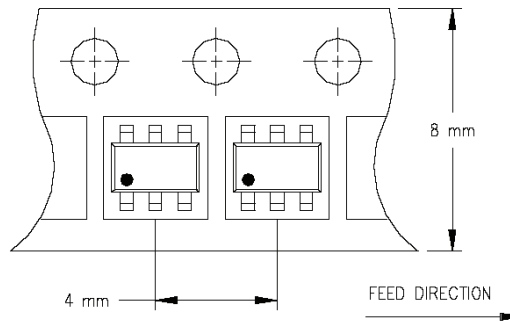
TSOP-6 Tape & Reel Information

NOTES:

1. OUTLINE CONFORMS TO EIA-481 & EIA-541.

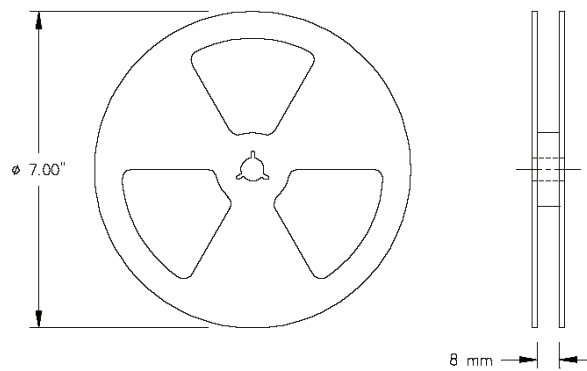

NOTES:

1. OUTLINE CONFORMS TO EIA-481 & EIA-541.

Note: For the most current drawing please refer to Infineon's web site www.infineon.com

Qualification Information

Qualification Level	Consumer (per JEDEC JESD47F) †	
Moisture Sensitivity Level	TSOP-6	MSL1 (per JEDEC J-STD-020D) †
RoHS Compliant	Yes	

† Applicable version of JEDEC standard at the time of product release.

Revision History

Date	Comments
01/27/2017	<ul style="list-style-type: none"> Changed datasheet with Infineon logo-all pages Updated package outline and part marking on page 8. Added disclaimer on last page.

Trademarks of Infineon Technologies AG

μHVIC™, μIPM™, μPFC™, AU-ConvertIR™, AURIX™, C166™, CanPAK™, CIPOS™, CIPURSE™, CoolDP™, CoolGaN™, COOLiR™, CoolMOST™, CoolSET™, CoolSiC™, DAVE™, DI-POL™, DirectFET™, DrBlade™, EasyPIM™, EconoBRIDGE™, EconoDUAL™, EconoPACK™, EconoPIM™, EiceDRIVER™, eupec™, FCOS™, GaNpowIR™, HEXFET™, HITFET™, HybridPACK™, iMOTION™, IRAM™, ISOFACE™, IsoPACK™, LEDrivIR™, LITIX™, MIPAQ™, ModSTACK™, my-d™, NovalithIC™, OPTIGA™, OptiMOST™, ORIGA™, PowIRaudio™, PowIRStage™, PrimePACK™, PrimeSTACK™, PROFET™, PRO-SiL™, RASiC™, REAL3™, SmartLEWIS™, SOLID FLASH™, SPOC™, StrongIRFET™, SupIRBuck™, TEMPFET™, TRENCHSTOP™, TriCore™, UHVIC™, XHP™, XMC™

Trademarks updated November 2015

Other Trademarks

All referenced product or service names and trademarks are the property of their respective owners.

Edition 2016-04-19
Published by
**Infineon Technologies AG
81726 Munich, Germany**
**© 2016 Infineon Technologies AG.
All Rights Reserved.**
Do you have a question about this document?
Email: erratum@infineon.com
**Document reference
ifx1**
IMPORTANT NOTICE

The information given in this document shall in no event be regarded as a guarantee of conditions or **characteristics ("Beschaffenheitsgarantie")**.

With respect to any examples, hints or any typical values stated herein and/or any information regarding the application of the product, Infineon Technologies hereby disclaims any and all warranties and liabilities of any kind, including without limitation warranties of non-infringement of intellectual property rights of any third party.

In addition, any information given in this document **is subject to customer's compliance with its obligations** stated in this document and any applicable legal requirements, norms and standards concerning customer's products and any use of the product of Infineon Technologies in **customer's applications**.

The data contained in this document is exclusively intended for technically trained staff. It is the **responsibility of customer's technical departments** to evaluate the suitability of the product for the intended application and the completeness of the product information given in this document with respect to such application.

For further information on the product, technology, delivery terms and conditions and prices please contact your nearest Infineon Technologies office (www.infineon.com).

Please note that this product is not qualified according to the AEC Q100 or AEC Q101 documents of the Automotive Electronics Council.

WARNINGS

Due to technical requirements products may contain dangerous substances. For information on the types in question please contact your nearest Infineon Technologies office.

Except as otherwise explicitly approved by Infineon Technologies in a written document signed by authorized representatives of Infineon Technologies, **Infineon Technologies' products may not be used** in any applications where a failure of the product or any consequences of the use thereof can reasonably be expected to result in personal injury.

OUR CERTIFICATE

DiGi provide top-quality products and perfect service for customer worldwide through standardization, technological innovation and continuous improvement. DiGi through third-party certification, we stricly control the quality of products and services. Welcome your RFQ to

Email: Info@DiGi-Electronics.com



Tel: +00 852-30501935

RFQ Email: Info@DiGi-Electronics.com

DiGi is a global authorized distributor of electronic components.