

IRF7424TRPBF Datasheet



DiGi Electronics Part Number	IRF7424TRPBF-DG
Manufacturer	Infineon Technologies
Manufacturer Product Number	IRF7424TRPBF
Description	MOSFET P-CH 30V 11A 8SO
Detailed Description	P-Channel 30 V 11A (Ta) 2.5W (Ta) Surface Mount 8-SO

<https://www.DiGi-Electronics.com>



Tel: +00 852-30501935

RFQ Email: Info@DiGi-Electronics.com

DiGi is a global authorized distributor of electronic components.

Purchase and inquiry

Manufacturer Product Number:

IRF7424TRPBF

Series:

HEXFET®

FET Type:

P-Channel

Drain to Source Voltage (Vdss):

30 V

Drive Voltage (Max Rds On, Min Rds On):

4.5V, 10V

Vgs(th) (Max) @ Id:

2.5V @ 250µA

Vgs (Max):

±20V

FET Feature:

-

Operating Temperature:

-55°C ~ 150°C (Tj)

Supplier Device Package:

8-SO

Base Product Number:

IRF7424

Manufacturer:

Infineon Technologies

Product Status:

Active

Technology:

MOSFET (Metal Oxide)

Current - Continuous Drain (Id) @ 25°C:

11A (Ta)

Rds On (Max) @ Id, Vgs:

13.5mOhm @ 11A, 10V

Gate Charge (Qg) (Max) @ Vgs:

110 nC @ 10 V

Input Capacitance (Ciss) (Max) @ Vds:

4030 pF @ 25 V

Power Dissipation (Max):

2.5W (Ta)

Mounting Type:

Surface Mount

Package / Case:

8-SOIC (0.154", 3.90mm Width)

Environmental & Export classification

RoHS Status:

ROHS3 Compliant

REACH Status:

REACH Unaffected

HTSUS:

8541.29.0095

Moisture Sensitivity Level (MSL):

1 (Unlimited)

ECCN:

EAR99

International
IR Rectifier

PD- 95343

IRF7424PbF

HEXFET® Power MOSFET

- Ultra Low On-Resistance
- P-Channel MOSFET
- Surface Mount
- Available in Tape & Reel
- Lead-Free

V_{DSS}	$R_{DS(on)}$ max (m Ω)	I_D
-30V	13.5@ $V_{GS} = -10V$	-11A
	22@ $V_{GS} = -4.5V$	-8.8A

Description

These P-Channel MOSFETs from International Rectifier utilize advanced processing techniques to achieve the extremely low on-resistance per silicon area. This benefit provides the designer with an extremely efficient device for use in battery and load management applications..

The SO-8 has been modified through a customized leadframe for enhanced thermal characteristics and multiple-die capability making it ideal in a variety of power applications. With these improvements, multiple devices can be used in an application with dramatically reduced board space. The package is designed for vapor phase, infrared, or wave soldering techniques.

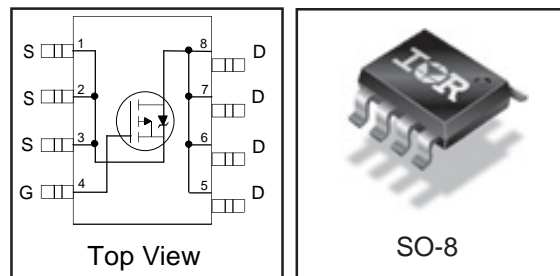

Absolute Maximum Ratings

	Parameter	Max.	Units
V_{DS}	Drain- Source Voltage	-30	V
$I_D @ T_A = 25^\circ C$	Continuous Drain Current, $V_{GS} @ -10V$	-11	A
$I_D @ T_A = 70^\circ C$	Continuous Drain Current, $V_{GS} @ -10V$	-9.3	
I_{DM}	Pulsed Drain Current ①	-47	
$P_D @ T_A = 25^\circ C$	Power Dissipation ③	2.5	W
$P_D @ T_A = 70^\circ C$	Power Dissipation ③	1.6	
	Linear Derating Factor	20	mW/ $^\circ C$
V_{GS}	Gate-to-Source Voltage	± 20	V
T_J, T_{STG}	Junction and Storage Temperature Range	-55 to + 150	$^\circ C$

Thermal Resistance

	Parameter	Max.	Units
$R_{\theta JA}$	Maximum Junction-to-Ambient ③	50	$^\circ C/W$

www.irf.com

1

10/04/04

IRF7424PbF

International
 Rectifier

Electrical Characteristics @ $T_J = 25^\circ\text{C}$ (unless otherwise specified)

	Parameter	Min.	Typ.	Max.	Units	Conditions
$V_{(BR)DSS}$	Drain-to-Source Breakdown Voltage	-30	—	—	V	$V_{GS} = 0V, I_D = -250\mu A$
$\Delta V_{(BR)DSS}/\Delta T_J$	Breakdown Voltage Temp. Coefficient	—	0.019	—	V/ $^\circ\text{C}$	Reference to 25°C , $I_D = -1\text{mA}$
$R_{DS(on)}$	Static Drain-to-Source On-Resistance	—	—	13.5	m Ω	$V_{GS} = -10V, I_D = -11A$ ②
		—	—	22		$V_{GS} = -4.5V, I_D = -8.8A$ ②
$V_{GS(th)}$	Gate Threshold Voltage	-1.0	—	-2.5	V	$V_{DS} = V_{GS}, I_D = -250\mu A$
g_{fs}	Forward Transconductance	17	—	—	S	$V_{DS} = -10V, I_D = -11A$
I_{DSS}	Drain-to-Source Leakage Current	—	—	-15	μA	$V_{DS} = -24V, V_{GS} = 0V$
		—	—	-25		$V_{DS} = -24V, V_{GS} = 0V, T_J = 70^\circ\text{C}$
I_{GSS}	Gate-to-Source Forward Leakage	—	—	-100	nA	$V_{GS} = -20V$
	Gate-to-Source Reverse Leakage	—	—	100		$V_{GS} = 20V$
Q_g	Total Gate Charge	—	75	110	nC	$I_D = -11A$
Q_{gs}	Gate-to-Source Charge	—	14	21		$V_{DS} = -15V$
Q_{gd}	Gate-to-Drain ("Miller") Charge	—	12	18		$V_{GS} = -10V$
$t_{d(on)}$	Turn-On Delay Time	—	15	—	ns	$V_{DD} = -15V$ ②
t_r	Rise Time	—	23	—		$I_D = -1.0A$
$t_{d(off)}$	Turn-Off Delay Time	—	150	—		$R_G = 6.0\Omega$
t_f	Fall Time	—	76	—		$V_{GS} = -10V$
C_{iss}	Input Capacitance	—	4030	—	pF	$V_{GS} = 0V$
C_{oss}	Output Capacitance	—	580	—		$V_{DS} = -25V$
C_{rss}	Reverse Transfer Capacitance	—	410	—		$f = 1.0\text{kHz}$

Source-Drain Ratings and Characteristics

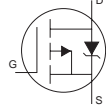
	Parameter	Min.	Typ.	Max.	Units	Conditions
I_S	Continuous Source Current (Body Diode)	—	—	-2.5	A	MOSFET symbol showing the integral reverse p-n junction diode. 
I_{SM}	Pulsed Source Current (Body Diode) ①	—	—	-47		
V_{SD}	Diode Forward Voltage	—	—	-1.2	V	$T_J = 25^\circ\text{C}, I_S = -2.5A, V_{GS} = 0V$ ②
t_{rr}	Reverse Recovery Time	—	40	60	ns	$T_J = 25^\circ\text{C}, I_F = -2.5A$
Q_{rr}	Reverse Recovery Charge	—	47	71	nC	$di/dt = -100A/\mu s$ ②

Notes:

- ① Repetitive rating; pulse width limited by max. junction temperature.
- ② Pulse width $\leq 400\mu s$; duty cycle $\leq 2\%$.
- ③ Surface mounted on 1 in square Cu board

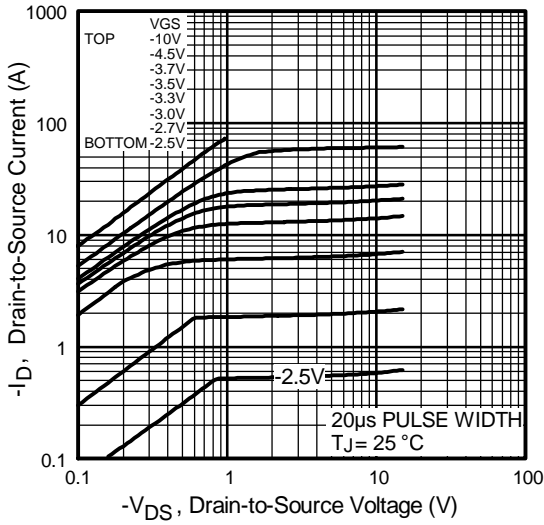

Fig 1. Typical Output Characteristics

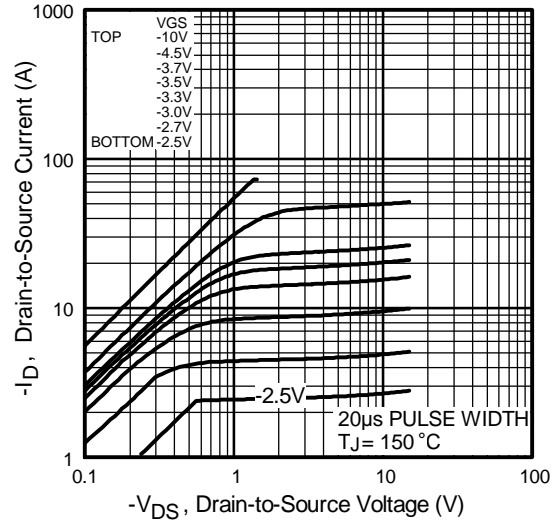

Fig 2. Typical Output Characteristics

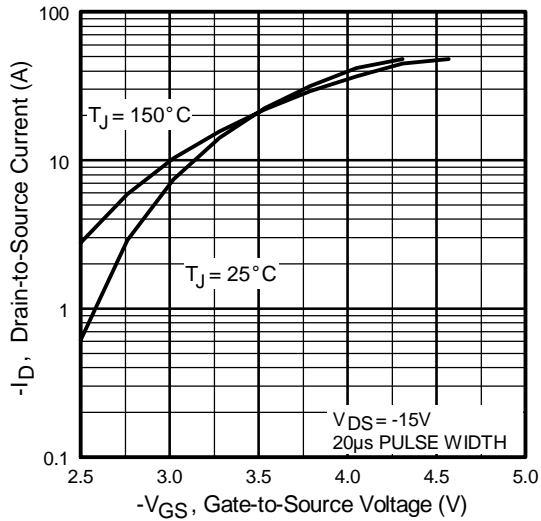

Fig 3. Typical Transfer Characteristics

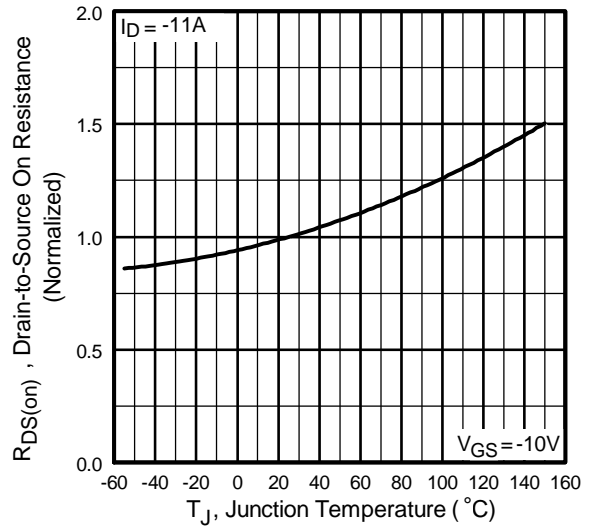

Fig 4. Normalized On-Resistance Vs. Temperature

IRF7424PbF

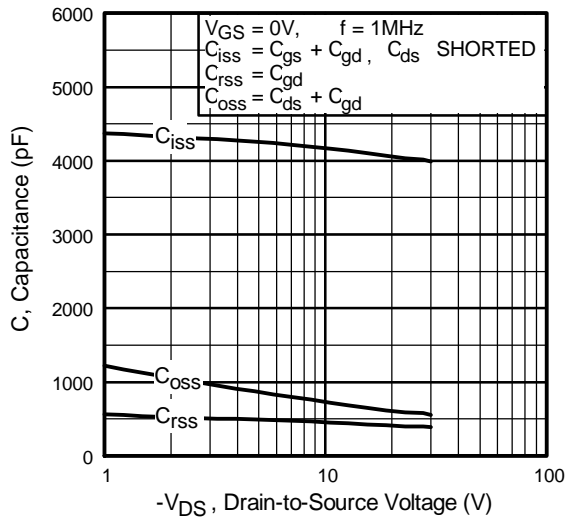

Fig 5. Typical Capacitance Vs. Drain-to-Source Voltage

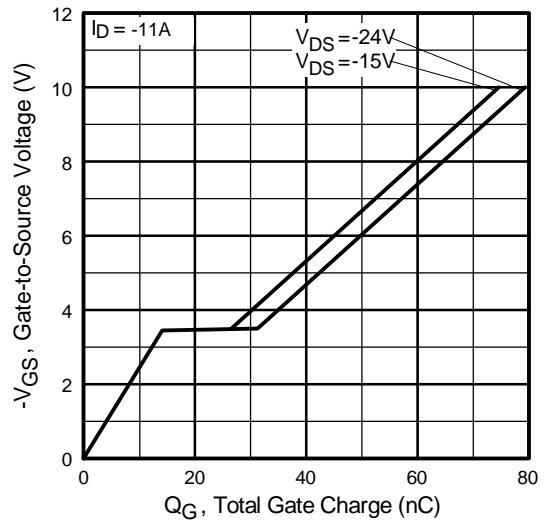

Fig 6. Typical Gate Charge Vs. Gate-to-Source Voltage

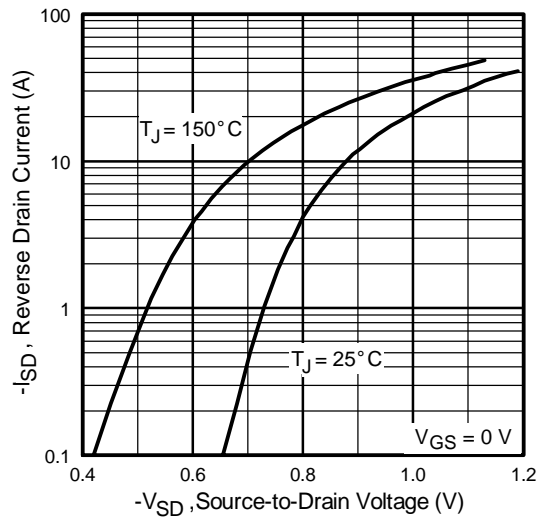

Fig 7. Typical Source-Drain Diode Forward Voltage

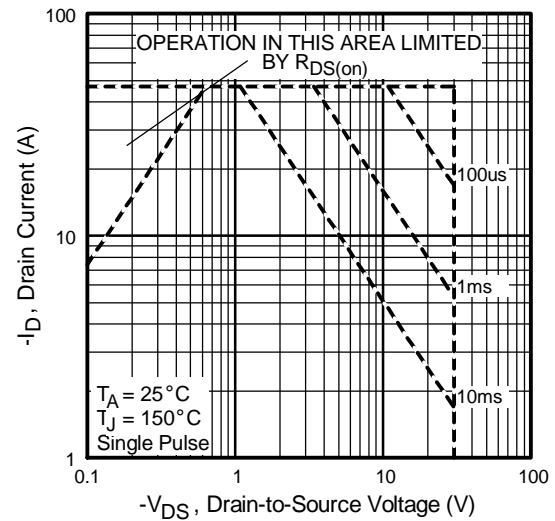

Fig 8. Maximum Safe Operating Area

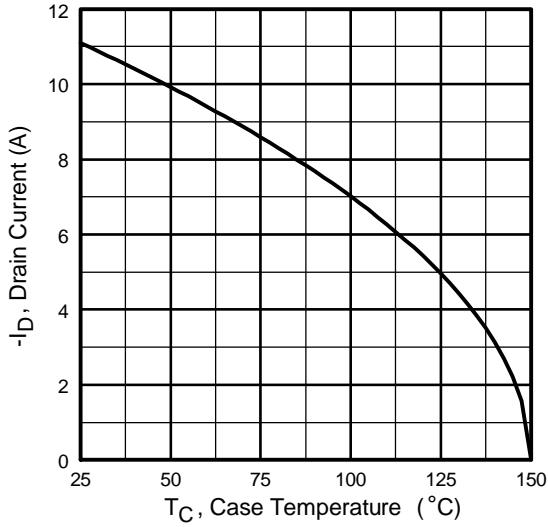

Fig 9. Maximum Drain Current Vs. Case Temperature

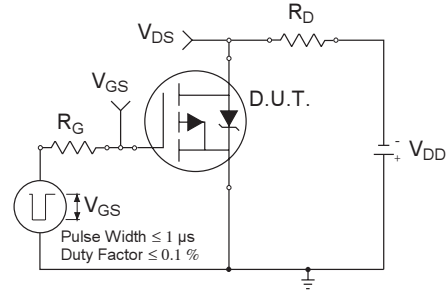

Fig 10a. Switching Time Test Circuit

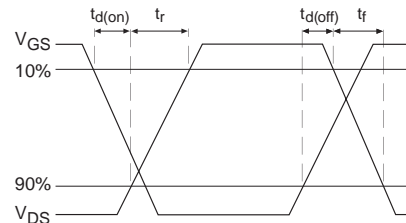

Fig 10b. Switching Time Waveforms

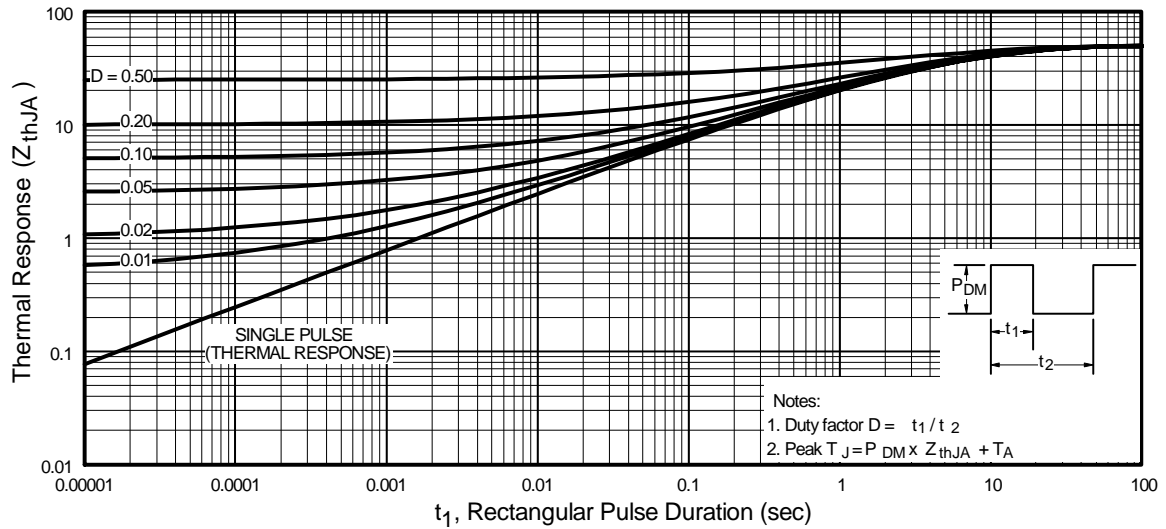

Fig 11. Maximum Effective Transient Thermal Impedance, Junction-to-Ambient

IRF7424PbF

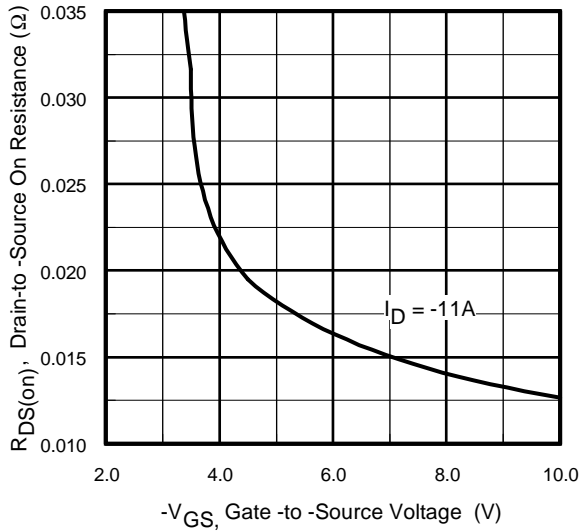

Fig 12. Typical On-Resistance Vs. Gate Voltage

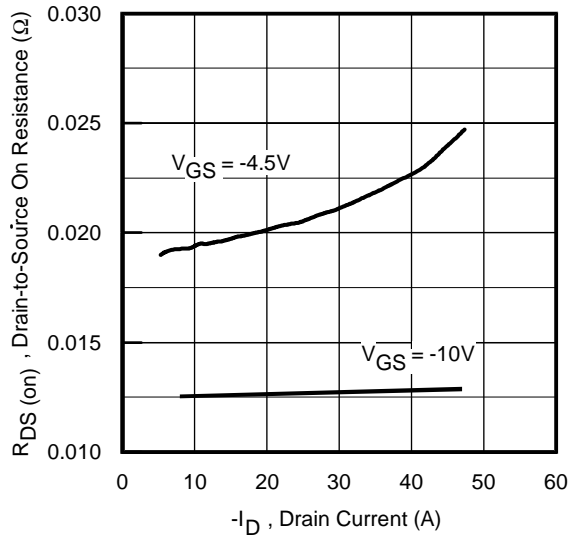

Fig 13. Typical On-Resistance Vs. Drain Current

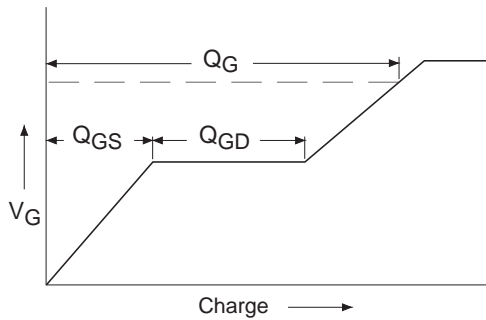

Fig 14a. Basic Gate Charge Waveform

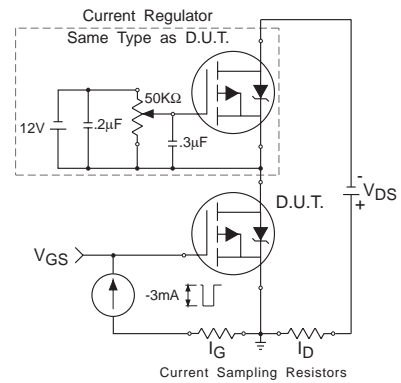

Fig 14b. Gate Charge Test Circuit

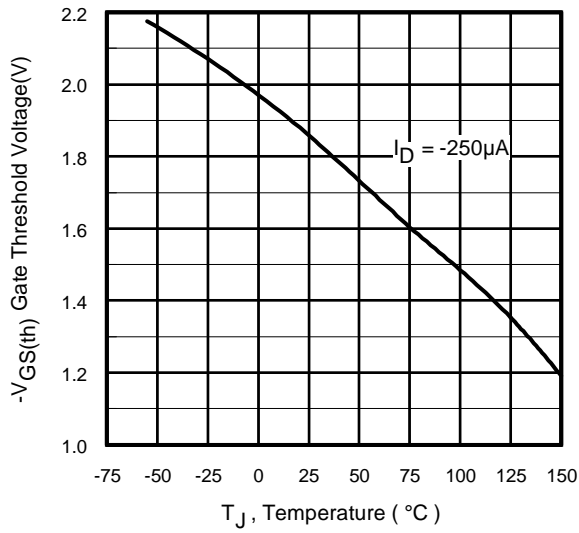

Fig 15. Typical $V_{GS(th)}$ Vs. Junction Temperature

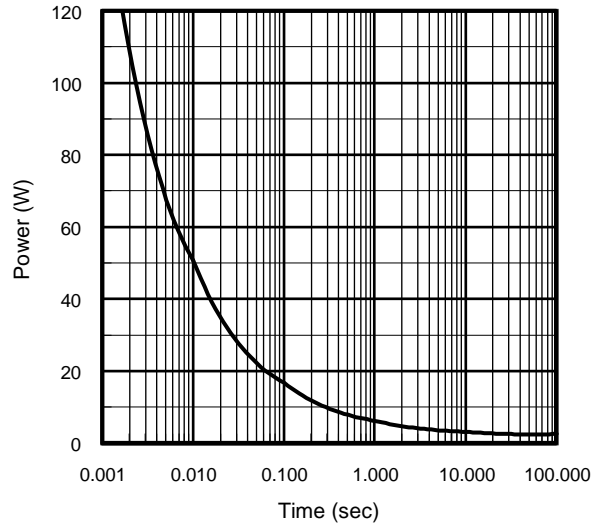

Fig 16. Typical Power Vs. Time

IRF7424PbF

International
IR Rectifier

SO-8 Package Outline

Dimensions are shown in millimeters (inches)

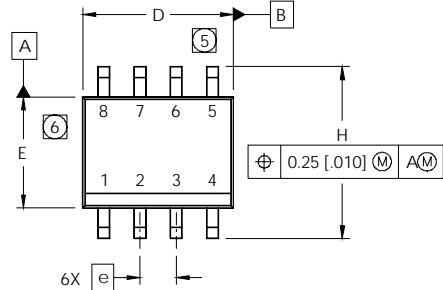

DIM	INCHES		MILLIMETERS	
	MIN	MAX	MIN	MAX
A	.0532	.0688	1.35	1.75
A1	.0040	.0098	0.10	0.25
b	.013	.020	0.33	0.51
c	.0075	.0098	0.19	0.25
D	.189	.1968	4.80	5.00
E	.1497	.1574	3.80	4.00
e	.050 BASIC		1.27 BASIC	
e1	.025 BASIC		0.635 BASIC	
H	.2284	.2440	5.80	6.20
K	.0099	.0196	0.25	0.50
L	.016	.050	0.40	1.27
y	0°	8°	0°	8°

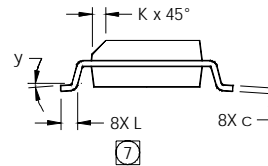
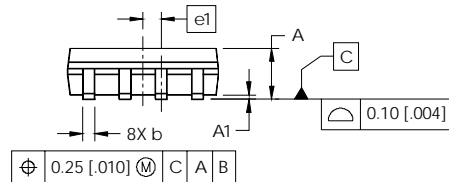

NOTES:

1. DIMENSIONING & TOLERANCING PER ASME Y14.5M-1994.
2. CONTROLLING DIMENSION: MILLIMETER
3. DIMENSIONS ARE SHOWN IN MILLIMETERS [INCHES].
4. OUTLINE CONFORMS TO JEDEC OUTLINE MS-012AA.
- ⑤ DIMENSION DOES NOT INCLUDE MOLD PROTRUSIONS. MOLD PROTRUSIONS NOT TO EXCEED 0.15 [0.006].
- ⑥ DIMENSION DOES NOT INCLUDE MOLD PROTRUSIONS. MOLD PROTRUSIONS NOT TO EXCEED 0.25 [0.010].
- ⑦ DIMENSION IS THE LENGTH OF LEAD FOR SOLDERING TO A SUBSTRATE.

FOOTPRINT

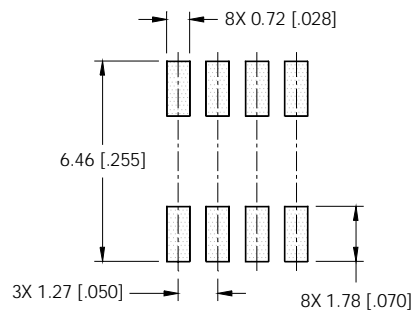

SO-8 Part Marking

EXAMPLE: THIS IS AN IRF7101 (MOSFET)

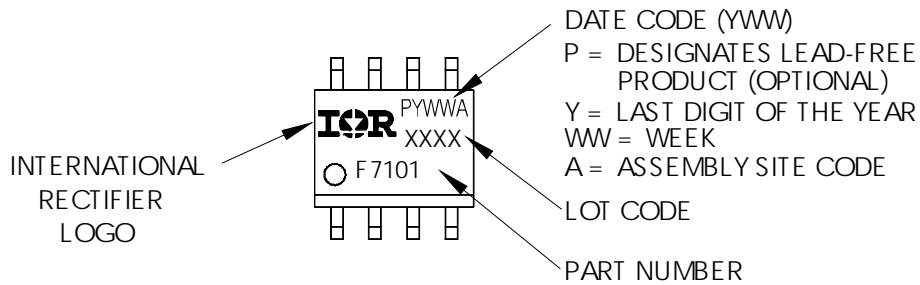

International
IR Rectifier

IRF7424PbF

SO-8 Tape and Reel

Dimensions are shown in millimeters (inches)

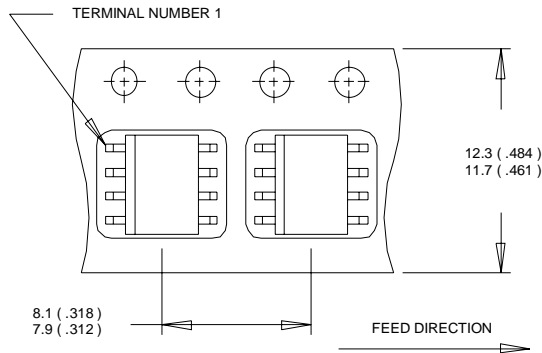

NOTES:

1. CONTROLLING DIMENSION : MILLIMETER.
2. ALL DIMENSIONS ARE SHOWN IN MILLIMETERS(INCHES).
3. OUTLINE CONFORMS TO EIA-481 & EIA-541.

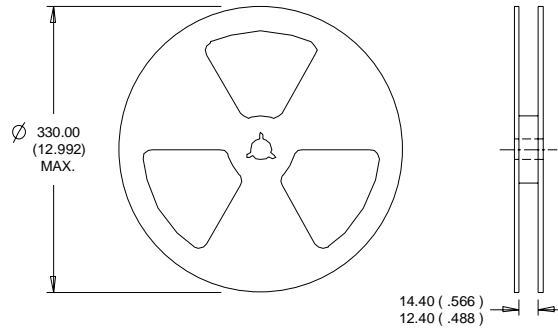

NOTES :

1. CONTROLLING DIMENSION : MILLIMETER.
2. OUTLINE CONFORMS TO EIA-481 & EIA-541.

Data and specifications subject to change without notice.
 This product has been designed and qualified for the Consumer market.
 Qualification Standards can be found on IR's Web site.

International
IR Rectifier

IR WORLD HEADQUARTERS: 233 Kansas St., El Segundo, California 90245, USA Tel: (310) 252-7105
 TAC Fax: (310) 252-7903

Visit us at www.irf.com for sales contact information.10/04

IMPORTANT NOTICE

The information given in this document shall in no event be regarded as a guarantee of conditions or characteristics ("Beschaffheitsgarantie").

With respect to any examples, hints or any typical values stated herein and/or any information regarding the application of the product, Infineon Technologies hereby disclaims any and all warranties and liabilities of any kind, including without limitation warranties of non-infringement of intellectual property rights of any third party.

In addition, any information given in this document is subject to customer's compliance with its obligations stated in this document and any applicable legal requirements, norms and standards concerning customer's products and any use of the product of Infineon Technologies in customer's applications.

The data contained in this document is exclusively intended for technically trained staff. It is the responsibility of customer's technical departments to evaluate the suitability of the product for the intended application and the completeness of the product information given in this document with respect to such application.

For further information on the product, technology, delivery terms and conditions and prices please contact your nearest Infineon Technologies office (www.infineon.com).

WARNINGS

Due to technical requirements products may contain dangerous substances. For information on the types in question please contact your nearest Infineon Technologies office.

Except as otherwise explicitly approved by Infineon Technologies in a written document signed by authorized representatives of Infineon Technologies, Infineon Technologies' products may not be used in any applications where a failure of the product or any consequences of the use thereof can reasonably be expected to result in personal injury.

OUR CERTIFICATE

DiGi provide top-quality products and perfect service for customer worldwide through standardization, technological innovation and continuous improvement. DiGi through third-party certification, we stricly control the quality of products and services. Welcome your RFQ to

Email: Info@DiGi-Electronics.com



Tel: +00 852-30501935

RFQ Email: Info@DiGi-Electronics.com

DiGi is a global authorized distributor of electronic components.