

PVT412 Datasheet



<https://www.DiGi-Electronics.com>

DiGi Electronics Part Number	PVT412-DG
Manufacturer	Infineon Technologies
Manufacturer Product Number	PVT412
Description	SSR RELAY SPST-NO 140MA 0-400V
Detailed Description	Solid State SPST-NO (1 Form A) 6-DIP (0.300", 7.62mm)

This model PVT412 is available at DiGi Electronics.

DiGi Electronics offers a global database of semiconductor and electronic component datasheets.

We welcome your inquiries regarding pricing, lead time, or other product-related questions.

 [Request a Quote](#)

 [Datasheet Search](#)



Tel: +00 852-30501935

RFQ Email: Info@DiGi-Electronics.com

DiGi is a global authorized distributor of electronic components.

Purchase and inquiry

Manufacturer Product Number:

PVT412

Series:

PVT, HEXFET®

Mounting Type:

Through Hole

Output Type:

AC, DC

Voltage - Load:

0 V ~ 400 V

On-State Resistance (Max):

27 Ohms

Package / Case:

6-DIP (0.300", 7.62mm)

Manufacturer:

Infineon Technologies

Product Status:

Obsolete

Circuit:

SPST-NO (1 Form A)

Voltage - Input:

1.2VDC

Load Current:

140 mA

Termination Style:

PC Pin

Supplier Device Package:

6-DIP

Environmental & Export classification

RoHS Status:

RoHS non-compliant

REACH Status:

REACH Unaffected

HTSUS:

8536.41.0030

Moisture Sensitivity Level (MSL):

1 (Unlimited)

ECCN:

EAR99

Microelectronic Power IC

HEXFET® Power MOSFET Photovoltaic Relay
Single-Pole, Normally-Open, 0-400V, 140mA AC/DC

General Description

The PVT412 Series Photovoltaic Relay is a single-pole, normally open solid-state relay that can replace electromechanical relays in many applications. It utilizes International Rectifier's proprietary HEXFET power MOSFET as the output switch, driven by an integrated circuit photovoltaic generator of novel construction. The output switch is controlled by radiation from a GaAlAs light emitting diode (LED) which is optically isolated from the photovoltaic generator.

These SSRs are specifically designed for worldwide telecom applications. PVT412L employs an active current-limiting circuitry enabling it to pass FCC Part 68 and other regulatory agency current surge requirements when overvoltage protection is provided. PVT412 does not employ the current-limiting circuitry and offers lower on-state resistance. Series PVT412 Relays are packaged in a 6-lead molded DIP package with either thru-hole or surface mount ('gull-wing') terminals. It is available in standard plastic shipping tubes or on tape-and-reel. Please refer to part identification information opposite.

Features

- HEXFET Power MOSFET output
- Bounce-free operation
- 4,000 V_{RMS} I/O isolation
- Load current limiting
- Linear AC/DC operation
- Solid-State Reliability
- UL recognized and BABT certified;
- ESD Tolerance:
 - 4000V Human Body Model
 - 500V Machine Model

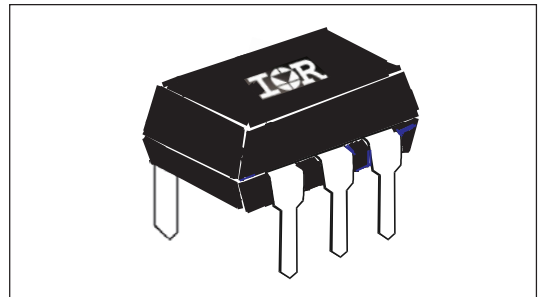

Applications

- On/Off Hook switch
- Dial-Out relay
- Ring relay
- General switching

Part Identification

PVT412LPbF	current limit, thru-hole
PVT412LSPbF	current limit, surface-mount
PVT412LS-TPbF	current limit, surface-mount, tape and reel
PVT412PbF	no current limit, thru-hole
PVT412SPbF	no current limit, surface-mount
PVT412S-TPbF	no current limit, surface-mount tape and reel

(HEXFET is the registered trademark for International Rectifier Power MOSFETs)

Electrical Specifications ($-40^{\circ}\text{C} \leq T_A \leq +85^{\circ}\text{C}$ unless otherwise specified)

INPUT CHARACTERISTICS	Part Numbers		Units
	PVT412L	PVT412	
Minimum Control Current (see figures 1 and 2)	3.0		mA
Maximum Control Current for Off-State Resistance	0.4		mA
Control Current Range (Caution: current limit input LED, see figure 6)	3.0 to 25		mA
Maximum Reverse Voltage	6.0		V

OUTPUT CHARACTERISTICS	PVT412L	PVT412	
Operating Voltage Range	0 to ± 400		V(DC or AC peak)
Maximum Load Current @ $T_A = +40^{\circ}\text{C}$ 5mA Control (see figures 1 and 2)			mA (AC or DC) mA (DC) mA (DC)
A Connection	120	140	
B Connection	130	150	
C Connection	200	210	
Maximum On-State Resistance @ $T_A = +25^{\circ}\text{C}$ For 50mA Pulsed Load, 5mA Control (see figure 4)			Ω Ω Ω
A Connection	35	27	
B Connection	18	14	
C Connection	9	7	
Maximum Off-State Leakage @ $T_A = +25^{\circ}\text{C}$, $\pm 400\text{V}$ (see figure 5)	1.0		μA
Current Limit @ $T_A = +25^{\circ}\text{C}$, For 5mA Control Current:			mA mA
Connection:	A	C	
Minimum	130	260	
Maximum	220	440	n/a n/a
Complies with FCC Part 68 Surge Requirements*	yes		yes
Maximum Turn-On Time @ $T_A = +25^{\circ}\text{C}$ (see figure 7) For 50mA, 100 V _{DC} load, 5mA Control	2.0		ms
Maximum Turn-Off Time @ $T_A = +25^{\circ}\text{C}$ (see figure 7) For 50mA, 100 V _{DC} load, 5mA Control	0.5		ms
Maximum Thermal Offset Voltage @ 5mA Control	0.5		μV
Maximum Output Capacitance @ 50V _{DC}	12		pF

GENERAL CHARACTERISTICS	ALL MODELS		
Minimum Dielectric Strength, Input-Output	4000	V _{RMS}	
Minimum Insulation Resistance, Input-Output @ $T_A = +25^{\circ}\text{C}$, 50%RH, 100V _{DC}	10^{12}	Ω	
Maximum Capacitance, Input-Output	1.0	pF	
Maximum Pin Soldering Temperature (10 seconds maximum)	+260	$^{\circ}\text{C}$	
Ambient Temperature Range:	Operating		-40 to +85
	Storage		-40 to +100

International Rectifier does not recommend the use of this product in aerospace, avionics, military or life support applications. Users of this International Rectifier product in such applications assume all risks of such use and indemnify International Rectifier against all damages resulting from such use.

Connection Diagrams

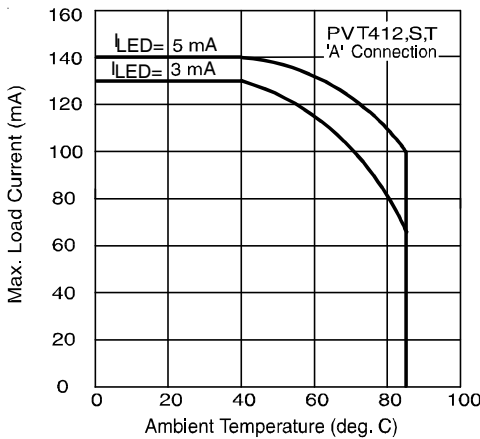
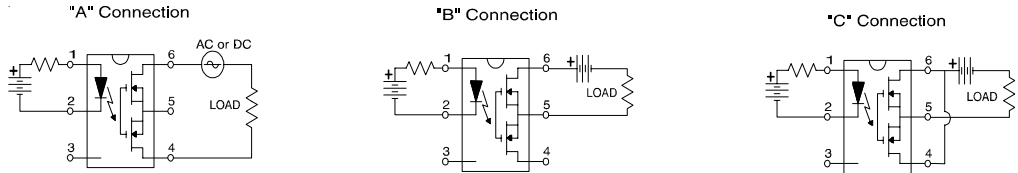

Figure 1. Current Derating Curves*

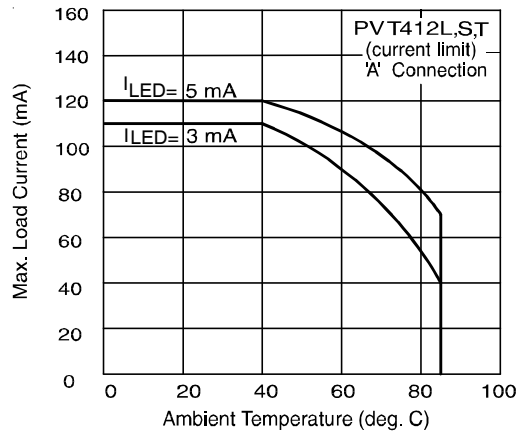

Figure 2. Current Derating Curves*

* Derating of 'B' and 'C' connection at +85°C will be 70% of that specified at +40°C and is linear from +40°C to +85°C.

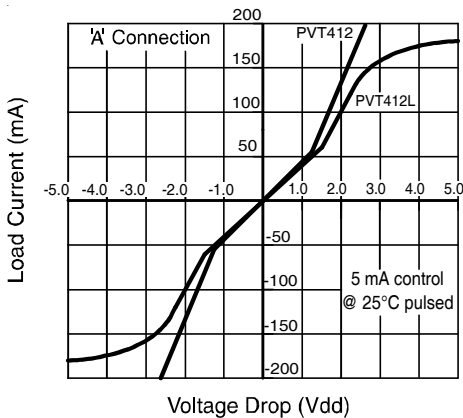

Figure 3. Linearity Characteristics

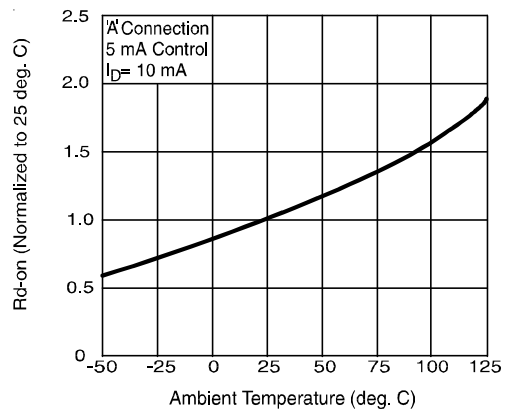

Figure 4. Typical Normalized On-Resistance

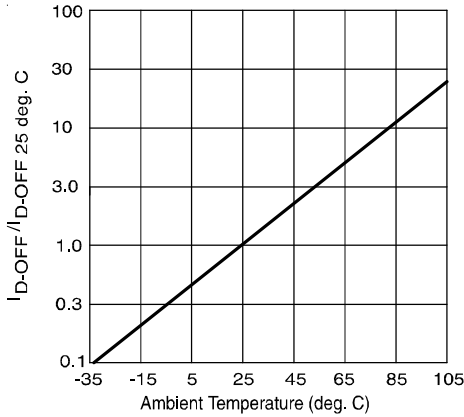

Figure 5. Typical Normalized Off-State Leakage

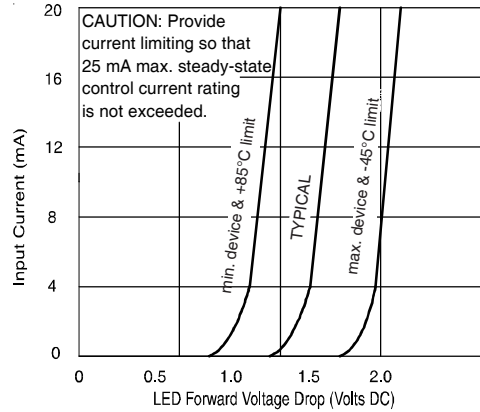

Figure 6. Input Characteristics (Current Controlled)

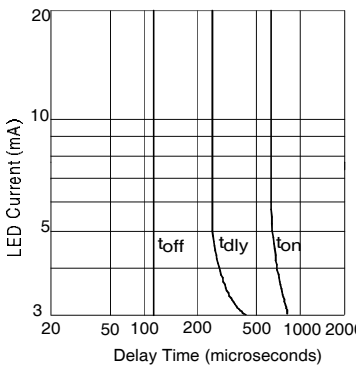

Figure 7. Typical Delay Times

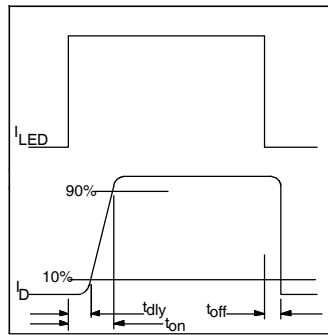

Figure 8. Delay Time Definitions

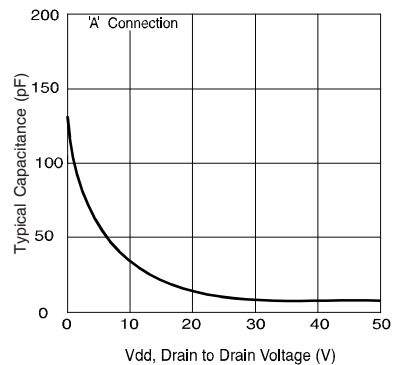
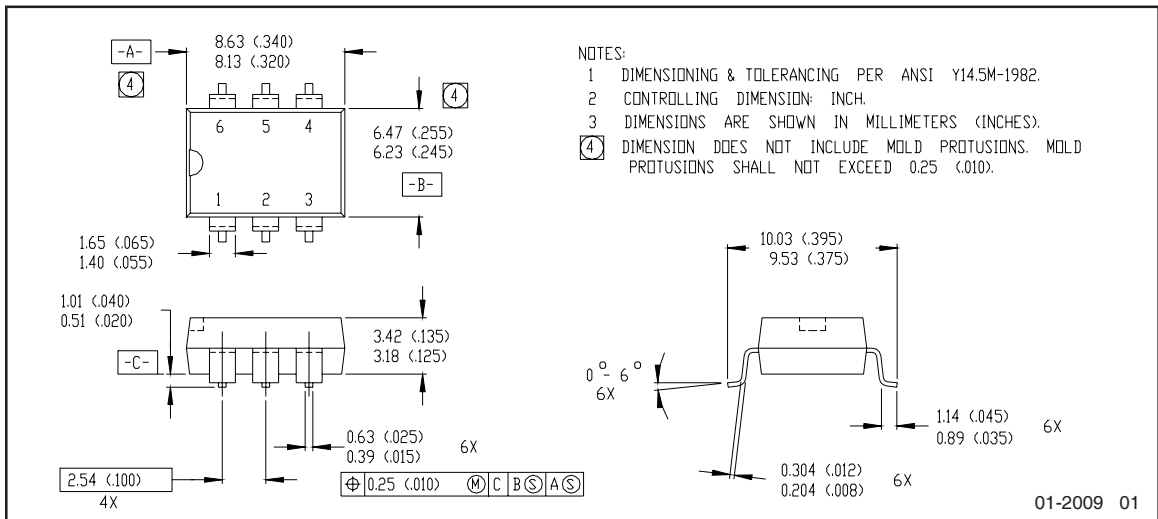
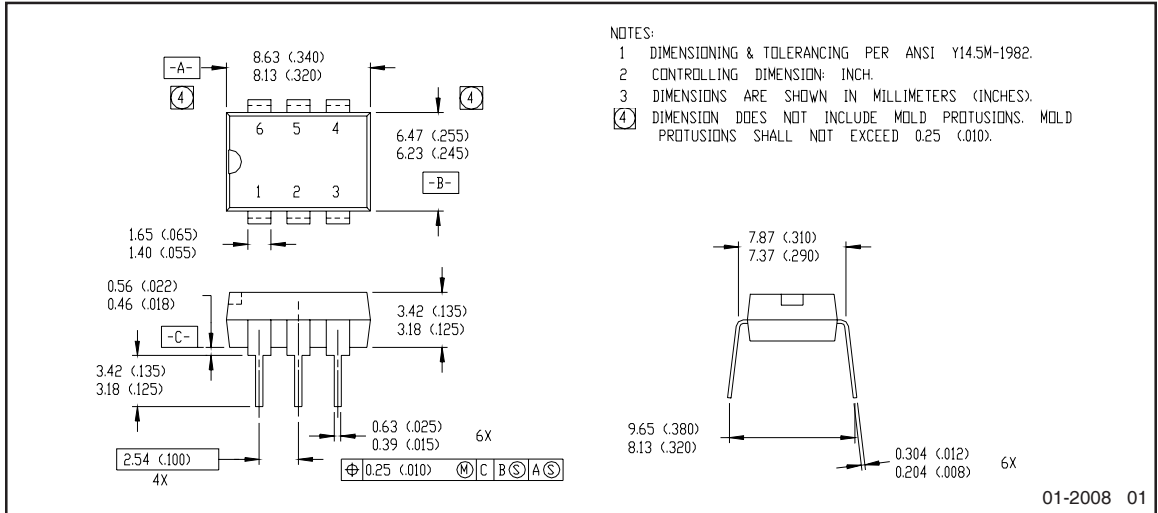

Figure 9. Typical Output Capacitance

Case Outlines



Note: For the most current drawing please refer to IR website at: <http://www.irf.com/package/>

Qualification information[†]

Qualification level	Industrial (per JEDEC JESD471 ^{††} guidelines)	
Moisture Sensitivity Level	PVT412LPbF	N/A
	PVT412PbF	
	PVT412LSPbF	MSL4 (per JEDEC J-STD-020E & JEDEC J-STD-033C ^{††})
	PVT412LS-TPbF	
	PVT412SPbF	
PVT412S-TPbF		
RoHS compliant	Yes	

[†] Qualification standards can be found at International Rectifier's web site: <http://www.irf.com/product-info/reliability>

^{††} Applicable version of JEDEC standard at the time of product release

Revision History

Date	Comments
5/18/2015	<ul style="list-style-type: none"> • Added Qualification Information Table on page 6 • Updated data sheet with new IR corporate template

International
 Rectifier

IR WORLD HEADQUARTERS: 101 N. Sepulveda Blvd., El Segundo, California 90245, USA
 Data and specifications subject to change without notice

To contact International Rectifier, please visit <http://www.irf.com/whoto-call/>

OUR CERTIFICATE

DiGi provide top-quality products and perfect service for customer worldwide through standardization, technological innovation and continuous improvement. DiGi through third-party certification, we strictly control the quality of products and services. Welcome your RFQ to

Email: Info@DiGi-Electronics.com



Tel: +00 852-30501935

RFQ Email: Info@DiGi-Electronics.com

DiGi is a global authorized distributor of electronic components.