

SC-02-090 Datasheet

www.digi-electronics.com



<https://www.DiGi-Electronics.com>

DiGi Electronics Part Number	SC-02-090-DG
Manufacturer	KEMET
Manufacturer Product Number	SC-02-090
Description	CMC 9.4MH 2A 2LN TH
Detailed Description	9.4 mH @ 10 kHz 2 Line Common Mode Choke Through Hole 2A DCR 100mOhm

This model SC-02-090 is available at DiGi Electronics.

DiGi Electronics offers a global database of semiconductor and electronic component datasheets.

We welcome your inquiries regarding pricing, lead time, or other product-related questions.

 [Request a Quote](#)

 [Datasheet Search](#)



Tel: +00 852-30501935

RFQ Email: Info@DiGi-Electronics.com

DiGi is a global authorized distributor of electronic components.

Purchase and inquiry

Manufacturer Product Number:

SC-02-090

Series:

SC

Filter Type:

Power Line

Inductance @ Frequency:

9.4 mH @ 10 kHz

DC Resistance (DCR) (Max):

100mOhm

Voltage Rating - AC:

250V

Ratings:

-

Features:

-

Size / Dimension:

1.024" Dia (26.00mm)

Package / Case:

Vertical, No Base, 4 PC Pin

Manufacturer:

KEMET

Product Status:

Active

Number of Lines:

2

Current Rating (Max):

2A

Voltage Rating - DC:

250V

Operating Temperature:

-40°C ~ 120°C

Approval Agency:

-

Mounting Type:

Through Hole

Height (Max):

1.024" (26.00mm)

Base Product Number:

SC-02

Environmental & Export classification

RoHS Status:

ROHS3 Compliant

REACH Status:

REACH Unaffected

HTSUS:

8548.00.0000

Moisture Sensitivity Level (MSL):

Not Applicable

ECCN:

EAR99

Common Mode SC Coils, Standard Series

Overview

The KEMET SC coils are common mode chokes with a wide variety of characteristics. These toroidal coils are designed with our proprietary ferrite cores and are useful in various noise countermeasure fields.

Applications

- Audio-visual equipment
- Home appliances
- Power supplies

Benefits

- Proprietary 5H, 7H and 10H ferrite material and equivalents
- Suitable for ≥ 150 kHz range
- Wide variety of sizes and specifications
- Operating temperature range from -40°C to $+105^{\circ}\text{C}$ or $+120^{\circ}\text{C}$
- UL 94 V-2 or V-0 flame retardant rated cap

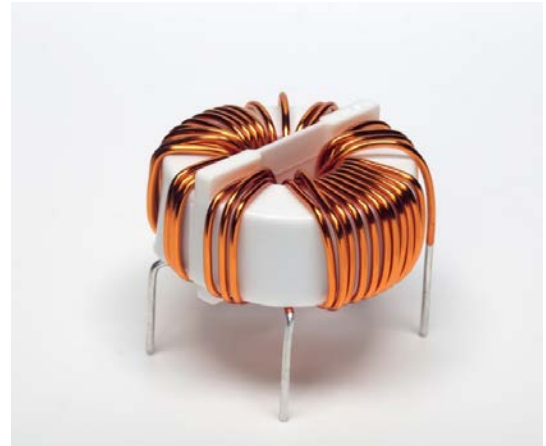
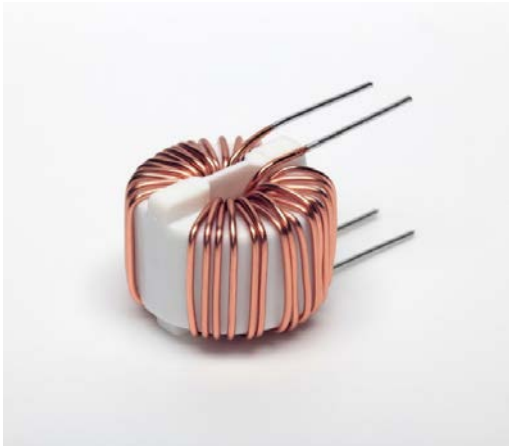

Part Number System

SC-		10-		200	
Series	Dimension Code (See Dimensions)	Rated Current (A)	Thermal Class	Inductance (mH) Minimum	Internal Control Code
SC	Blank 22	0x = x A x0 = x0 A xx = xx A Examples: 02 = 2 A 10 = 10 A 15 = 15 A Note: With exceptions, see Table 1 for details.	Blank E = Class E Note: With exceptions, see Table 1 for details.	x00 = x mH xx00 = xx mH xx0 = x.xmH Example: 200 = 2 mH 1100 = 11 mH 620 = 6.2 mH Note: With exceptions, see Table 1 for details.	Blank A B H V

Magnetic Permeability of Ferrite Material

In order to achieve most efficient noise reduction, it is important to select the material according to the target frequency band. Depending on its magnetic permeability, a particular ferrite material will be effective in a certain frequency band. A schematic representation of the relationship between the magnetic permeability of each material and the corresponding effective band range is shown in Figure 1. Materials with higher magnetic permeability are effective in the lower frequency range, while those with lower magnetic permeability are effective in the higher frequency range. Thus, Mn-Zn products are mainly used for reducing conduction noise, while Ni-Zn products are commonly used for radiation noise countermeasures.

The effective frequency range varies depending on core shape, size and number of windings. This frequency dependence of the magnetic permeability as shown in the figure serves for reference purposes only and it should be tested on the actual device to determine its effectiveness.

S18H, S15H, 10H, 7H, 5H, 1400L and 700L are KEMET's proprietary ferrite material names. Other materials can also be available on request.

Figure 1 - Relationship between the magnetic permeability of each material and its effective frequency range

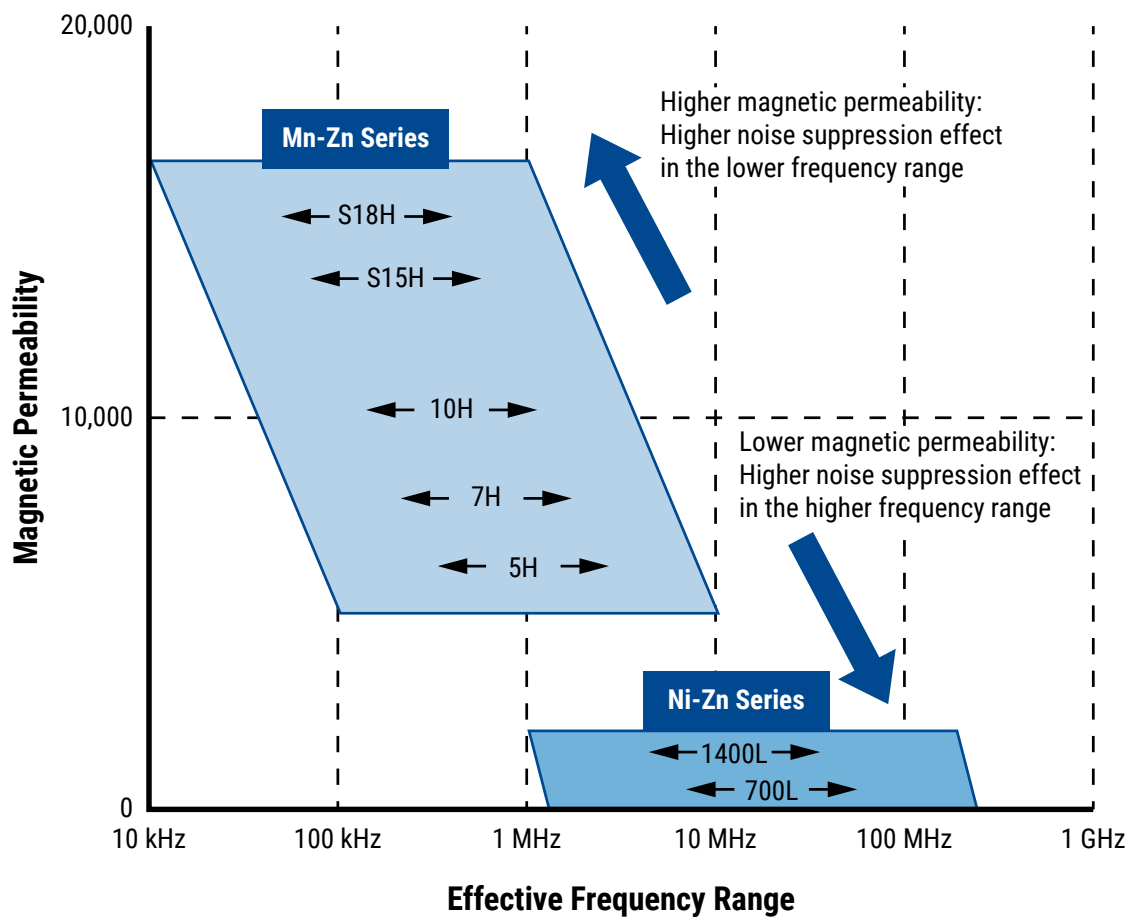

Dimensions – Millimeters

Figure 1

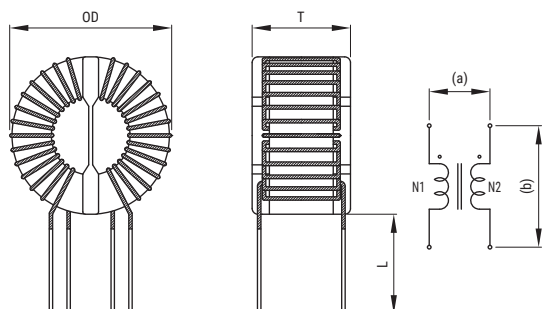
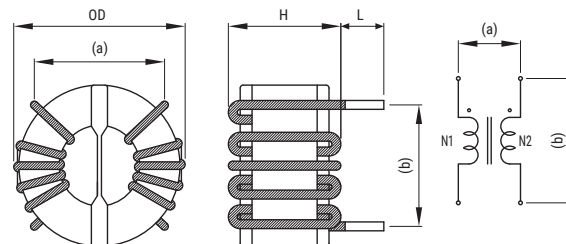

Figure 2



Part Name	Dimensions (mm)				Pin Pitch ¹ (Reference)		Figure
	OD (Maximum)	T (Maximum)	H (Maximum)	L	a	b	
SC-02-101	23.0	13.0	-	15.0±2.0	6	11	Fig. 1
SC-02-100	23.0	18.5	-	15.0±2.0	6	17	Fig. 1
SC-02-200	23.0	18.5	-	15.0±2.0	6	17	Fig. 1
SC-02-300	27.0	20.0	-	15.0±2.0	6	17	Fig. 1
SC-02-500	27.0	20.0	-	15.0±2.0	6	17	Fig. 1
SC-02-E620H	27.0	-	20.0	15.0±2.0	15	15	Fig. 2
SC-02-800	34.0	23.0	-	15.0±2.0	7	20	Fig. 2
SC-02-090	26.0	14.5	-	15.0±2.0	6	13	Fig. 1
SC-03-E900	23.5	20.0	-	15.0±2.0	5	15	Fig. 1
SC-04-200	25.0	19.0	-	15.0±2.0	8	16	Fig. 1
SC-04-500	29.0	21.0	-	15.0±2.0	10	19	Fig. 1
SC-05-500	34.0	23.0	-	15.0±2.0	7	21	Fig. 1
SC-05-503	34.0	-	23.0	15.0±2.0	20	20	Fig. 2
SC-05-800	34.0	23.0	-	15.0±2.0	7	21	Fig. 1
SC-05-803	34.0	-	23.0	15.0±2.0	22	21	Fig. 2
SC-04-1600	34.0	23.0	-	15.0±2.0	8	22	Fig. 1
SC-04-E2000	34.0	23.0	-	15.0±2.0	18	18	Fig. 1
SC22-04-95H	30.0	-	19.0	4.0±1.0	10	20	Fig. 2
SC-05-E06H	25.0	-	13.0	5.0±1.0	15	15	Fig. 2
SC-05-100	25.0	18.5	-	15.0±2.0	6	17	Fig. 1
SC-05-103	25.0	-	18.5	15.0±2.0	15	15	Fig. 2
SC-05-200	32.0	22.0	-	15.0±2.0	7	21	Fig. 1
SC-05-203	32.0	-	22.0	15.0±2.0	22	21	Fig. 2
SC-05-300	32.0	22.0	-	15.0±2.0	8	22	Fig. 1
SC-05-1100	34.0	24.0	-	15.0±2.0	18	21	Fig. 1
SC-05-1503	34.0	23.0	-	15.0±2.0	6.5	19	Fig. 1
SC-06-101	25.0	-	19.0	8.0±2.0	10	19	Fig. 2
SC-06-E200H	25.0	-	19.0	8.0±2.0	10	19	Fig. 2
SC-06-900	34.0	24.0	-	15.0±2.0	8	22	Fig. 1
SC-07-030V	25.0	20.0	-	15.0±2.0	10	15	Fig. 1
SC-07-100	25.0	19.0	-	15.0±2.0	7	17	Fig. 1
SC-07-E300A	34.0	-	23.0	4.5±1.0	22	21	Fig. 2
SC-07-650	35.0	23.0	-	15.0±2.0	7	21	Fig. 1
SC22-08-100	30.0	-	19.0	5.0±2.0	14	22	Fig. 2
SC-08-100	35.0	-	23.0	15.0±2.0	22	21	Fig. 2

¹ Pin pitch listed above for reference only. Values not guaranteed.

Dimensions – Millimeters cont.

Figure 1

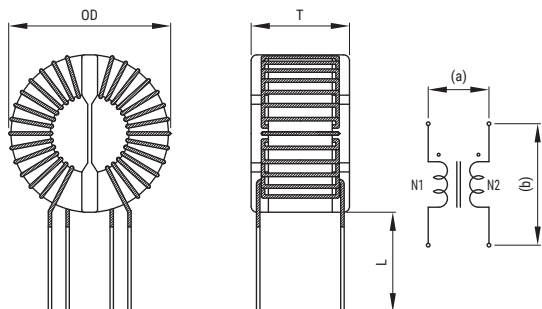
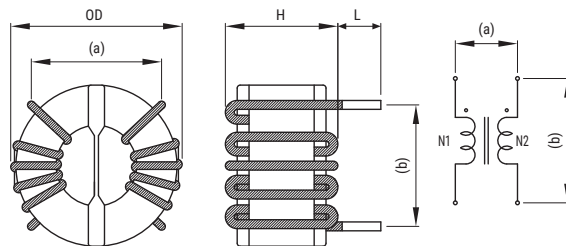

Figure 2



Part Name	Dimensions (mm)				Pin Pitch ¹ (Reference)		Figure
	OD (Maximum)	T (Maximum)	H (Maximum)	L	a	b	
SC22-08-170	30.0	-	19.0	5.0±2.0	14	22	Fig. 2
SC-08-170H	34.0	-	23.0	4.5±2.0	22	21	Fig. 2
SC-08-200B	34.0	22.0	-	15.0±2.0	6	19	Fig. 1
SC22-08-260	30.0	-	21.0	10.0±2.0	15	20	Fig. 2
SC-08-440	35.0	23.0	-	15.0±2.0	7	21	Fig. 1
SC-08-700	50.0	30.0	-	15.0±2.0	10	22	Fig. 1
SC-08-1000	50.0	28.0	-	20.0±2.0	10	22	Fig. 1
SC-08-E1000	50.0	28.0	-	20.0±2.0	10	20	Fig. 1
SC-09-1400	49.0	-	40.0	15.0±2.0	35	35	Fig. 2
SC-10-100	34.0	-	24.0	15.0±2.0	22	21	Fig. 2
SC-10-200	47.0	-	27.0	15.0±2.0	30	30	Fig. 2
SC-10-E200H	34.0	-	24.0	5.0±2.0	21	21	Fig. 2
SC-10-340	48.0	29.0	-	30.0±2.0	10	22	Fig. 1
SC-10-500	49.0	-	27.0	15.0±2.0	35	35	Fig. 2
SC-10-1000	57.0	-	30.0	15.0±2.0	20	55	Fig. 2
SC-12-300	49.0	-	28.0	15.0±2.0	35	35	Fig. 2
SC-15-01H	26.0	-	13.5	10.0±2.0	10	20	Fig. 2
SC-15-100	49.0	-	27.0	15.0±2.0	35	35	Fig. 2
SC-15-E110H	36.0	-	25.0	5.0±2.0	22	21	Fig. 2
SC-15-201	49.0	30.0	-	15.0±2.0	10	22	Fig. 1
SC-15-200	50.0	-	28.0	15.0±2.0	35	35	Fig. 2
SC-15-230	50.0	-	30.0	15.0±2.0	35	35	Fig. 2
SC-15-E350	50.0	28.0	-	15.0±2.0	10	20	Fig. 1
SC-15-E350H	50.0	-	28.0	15.0±2.0	20	40	Fig. 2
SC-18-100	34.0	-	23.0	15.0±2.0	22	21	Fig. 2
SC-18-180	50.0	-	30.0	15.0±2.0	35	35	Fig. 2
SC-18-290	40.0	-	28.0	5.0±2.0	17	33	Fig. 2
SC-20-100	60.0	-	30.0	15.0±2.0	40	40	Fig. 2
SC-20-104	52.0	-	31.0	15.0±2.0	20	40	Fig. 2
SC-20-201	49.0	30.0	-	15.0±2.0	10	22	Fig. 1
SC-20-300	63.0	-	35.0	15.0±2.0	20	50	Fig. 2
SC-20-400	63.0	-	35.0	15.0±2.0	20	50	Fig. 2
SC-30-050H	55.0	-	30.0	15.0±2.0	42	18	Fig. 2
SC-30-100	62.0	-	35.0	15.0±2.0	55	20	Fig. 2
SC-30-E100	63.0	-	35.0	4.5±2.5	55	20	Fig. 2

¹ Pin pitch listed above for reference only. Values not guaranteed.

Environmental Compliance

All KEMET AC line filters are RoHS Compliant.



Performance Characteristics

Item	Performance Characteristics
Rated Voltage	250 VAC/VDC
Withstanding Voltage	2,400 V (2 seconds, between lines)
Insulation Resistance	> 100 MΩ at 500 VDC (between lines)
Rated Current Range	2 – 30 A
Rated Inductance Range	0.067 – 20.3 mH minimum
Inductance Measurement Condition	1 kHz, 10 kHz, 16 kHz, and 100 kHz
Thermal Class	A (105°C) and E (120°C)
Operating Temperature Range	-40°C to +105°C (include self temperature rise) and -40°C to +120°C (include self temperature rise)

Table 1 – Ratings & Part Number Reference

Part Number	Rated Current (A)	Inductance (mH) Minimum	DC Resistance/Line (mΩ) Maximum	Temperature Rise (K) Maximum	Wire Diameter (mm)	Thermal Class	Weight (g) Approximate
SC-02-101	2.0	1.000 ⁴	110.0	40	0.60	A (105°C)	15.0
SC-02-100	2.0	1.000 ⁴	100.0	40	0.60	A (105°C)	15.0
SC-02-200	2.0	2.000 ⁴	110.0	40	0.60	A (105°C)	15.0
SC-02-300	2.0	3.000 ⁴	100.0	40	0.60	A (105°C)	16.0
SC-02-500	2.0	5.000 ⁴	100.0	45	0.60	A (105°C)	20.0
SC-02-E620H	2.0	6.200 ¹	180.0	40	0.55	E (120°C)	18.5
SC-02-800	2.0	8.000 ⁴	150.0	40	0.60	A (105°C)	25.0
SC-02-090	2.0	9.400 ²	100.0	40	0.65	E (120°C)	14.2
SC-03-E900	3.0	9.000 ²	130.0	70	0.60	E (120°C)	19.0
SC-04-200	4.0	2.000 ⁴	55.0	50	0.70	A (105°C)	17.5
SC-04-500	4.0	5.000 ²	70.0	50	0.70	A (105°C)	19.0
SC-05-500	4.0	5.000 ⁴	80.0	50	0.80	A (105°C)	30.0
SC-05-503	4.0	5.000 ⁴	80.0	50	0.80	A (105°C)	32.7
SC-05-800	4.0	8.000 ⁴	85.0	60	0.80	A (105°C)	40.0
SC-05-803	4.0	8.000 ⁴	90.0	60	0.80	A (105°C)	35.7
Part Number	Rated Current (A)	Inductance (mH) Minimum	DC Resistance/Line (mΩ) Maximum	Temperature Rise (K) Maximum	Wire Diameter (mm)	Thermal Class	Weight (g) Approximate

¹ Inductance Measurement Condition : 1 kHz

² Inductance Measurement Condition : 10 kHz

³ Inductance Measurement Condition : 16 kHz

⁴ Inductance Measurement Condition : 100 kHz

Table 1 – Ratings & Part Number Reference (cont.)

Part Number	Rated Current (A)	Inductance (mH) Minimum	DC Resistance/Line (mΩ) Maximum	Temperature Rise (K) Maximum	Wire Diameter (mm)	Thermal Class	Weight (g) Approximate
SC-04-1600	4.0	16.000 ¹	85.0	55	0.80	A (105°C)	39.8
SC-04-E2000	4.0	20.300 ²	150.0	75	0.80	E (120°C)	45.0
SC22-04-95H	4.3	9.450 ²	80.0	86	0.75	E (120°C)	31.8
SC-05-E06H	5.0	0.600 ²	17.5	35	0.85	E (120°C)	10.3
SC-05-100	5.0	1.000 ⁴	50.0	40	0.80	A (105°C)	20.0
SC-05-103	5.0	1.000 ⁴	50.0	40	0.80	A (105°C)	17.3
SC-05-200	5.0	2.000 ⁴	70.0	40	0.80	A (105°C)	25.0
SC-05-203	5.0	2.000 ⁴	70.0	40	0.80	A (105°C)	31.2
SC-05-300	5.0	3.000 ⁴	55.0	55	0.80	A (105°C)	32.8
SC-05-1100	5.0	11.000 ²	55.0	50	1.00	E (120°C)	46.7
SC-05-1503	5.0	10.500 ³	100.0	55	0.90	A (105°C)	41.0
SC-06-101	6.0	1.000 ⁴	27.0	40	0.90	E (120°C)	19.3
SC-06-E200H	6.0	2.000 ²	27.0	40	0.90	E (120°C)	20.1
SC-06-900	6.0	9.000 ¹	60.0	55	1.00	A (105°C)	44.0
SC-07-030V	7.0	0.360 ⁴	14.0	30	1.10	E (120°C)	18.9
SC-07-100	7.0	0.650 ⁴	14.0	45	1.10	A (105°C)	20.0
SC-07-E300A	7.0	3.000 ⁴	45.0	70	1.00	E (120°C)	40.0
SC-07-650	7.0	6.500 ¹	40.0	55	1.10	A (105°C)	45.3
SC22-08-100	8.0	1.000 ²	20.0	50	1.20	E (120°C)	27.3
SC-08-100	8.0	1.000 ⁴	25.0	50	1.20	A (105°C)	40.5
SC22-08-170	8.0	1.700 ²	20.0	50	1.20	E (120°C)	28.2
SC-08-170H	8.0	1.700 ²	20.0	45	1.20	A (105°C)	36.3
SC-08-200B	8.0	2.000 ⁴	70.0	40	1.20	A (105°C)	43.1
SC22-08-260	8.0	2.600 ¹	30.0	60	1.00	E (120°C)	25.7
SC-08-440	8.0	4.400 ¹	25.0	50	1.20	A (105°C)	44.2
SC-08-700	8.0	7.000 ¹	40.0	55	1.30	A (105°C)	103.6
SC-08-1000	8.0	10.000 ⁴	70.0	50	1.20	A (105°C)	104.5
SC-08-E1000	8.0	10.000 ⁴	70.0	50	1.20	E (120°C)	108.7
SC-09-1400	9.0	14.000 ¹	53.0	65	1.30	A (105°C)	170.1
SC-10-100	10.0	1.000 ⁴	20.0	40	1.30	A (105°C)	40.0
SC-10-200	10.0	2.000 ⁴	28.0	40	1.30	A (105°C)	80.0
SC-10-E200H	10.0	2.000 ²	20.0	45	1.30	E (120°C)	42.5
SC-10-340	10.0	3.400 ⁴	32.0	50	1.40	A (105°C)	105.7
SC-10-500	10.0	5.000 ⁴	25.0	55	1.50	A (105°C)	110.1
SC-10-1000	10.0	10.000 ⁴	35.0	50	1.50	A (105°C)	177.3
SC-12-300	12.0	3.000 ⁴	18.0	45	1.60	A (105°C)	103.8
SC-15-01H	15.0	0.067 ²	2.0	25	1.40	E (120°C)	10.0
SC-15-100	15.0	1.000 ⁴	12.0	40	1.80	A (105°C)	100.0
SC-15-E110H	15.0	1.100 ²	16.5	100	1.30	E (120°C)	41.5
SC-15-201	15.0	2.000 ⁴	12.0	50	1.80	E (120°C)	109.3
SC-15-200	15.0	2.000 ⁴	12.0	45	1.80	A (105°C)	110.0
SC-15-230	15.0	2.300 ⁴	13.0	55	1.80	A (105°C)	114.4
SC-15-E350	15.0	3.500 ⁴	20.0	80	1.60	E (120°C)	110.5
SC-15-E350H	15.0	3.500 ⁴	20.0	80	1.60	E (120°C)	111.3
SC-18-100	18.0	0.700 ⁴	20.0	50	1.70	A (105°C)	45.2
SC-18-180	18.0	1.800 ¹	11.0	75	1.90	A (105°C)	110.4
SC-18-290	18.0	2.900 ⁴	25.0	115	1.40	E (120°C)	77.5
SC-20-100	20.0	1.000 ⁴	8.0	45	2.30	A (105°C)	135.0
SC-20-104	20.0	1.000 ⁴	8.0	50	2.00	A (105°C)	103.3
SC-20-201	20.0	2.000 ²	10.0	75	1.90	E (120°C)	108.5
SC-20-300	20.0	3.000 ⁴	13.0	50	2.30	A (105°C)	202.0
SC-20-400	20.0	4.000 ¹	13.0	55	2.30	A (105°C)	205.0
SC-30-050H	30.0	0.500 ²	3.0	40	1.80 x 2 Parallel	A (105°C)	103.0
SC-30-100	30.0	1.000 ⁴	6.0	40	2.60	A (105°C)	190.0
SC-30-E100	30.0	1.000 ⁴	6.0	60	2.60	E (120°C)	200.0
Part Number	Rated Current (A)	Inductance (mH) Minimum	DC Resistance/Line (mΩ) Maximum	Temperature Rise (K) Maximum	Wire Diameter (mm)	Thermal Class	Weight (g) Approximate

¹ Inductance Measurement Condition : 1 kHz² Inductance Measurement Condition : 10 kHz³ Inductance Measurement Condition : 16 kHz⁴ Inductance Measurement Condition : 100 kHz

Frequency Characteristics

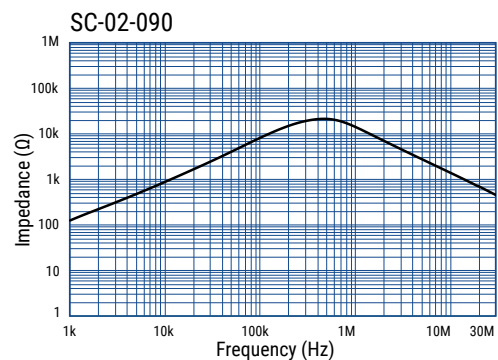
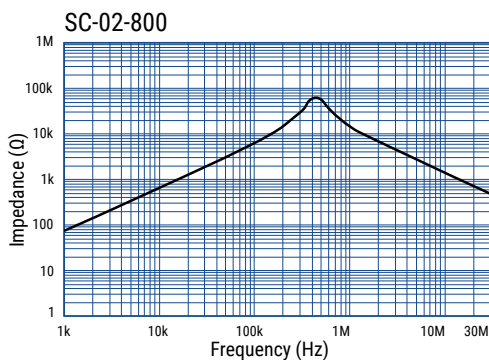
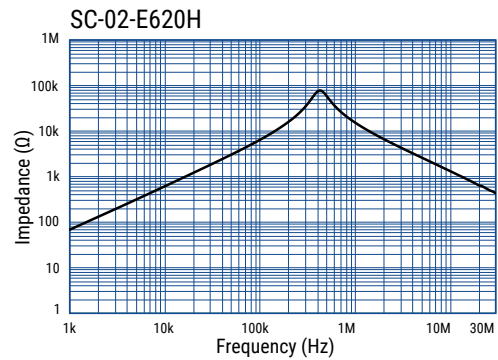
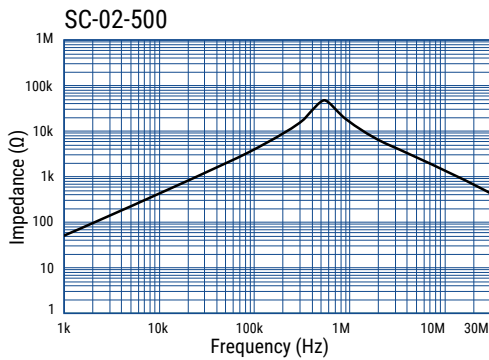
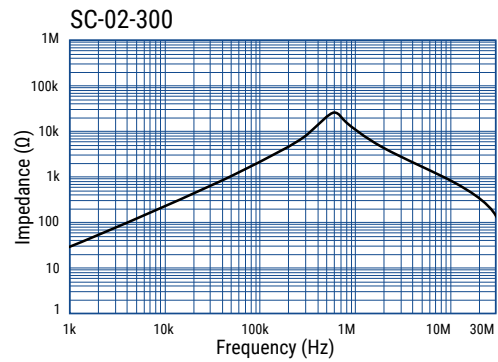
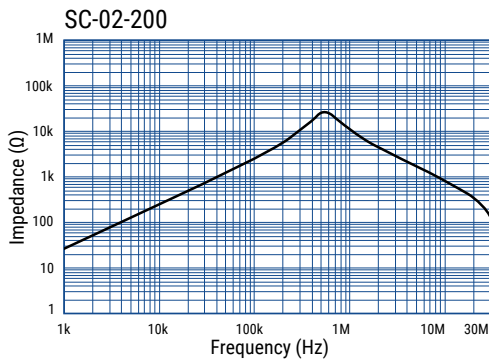
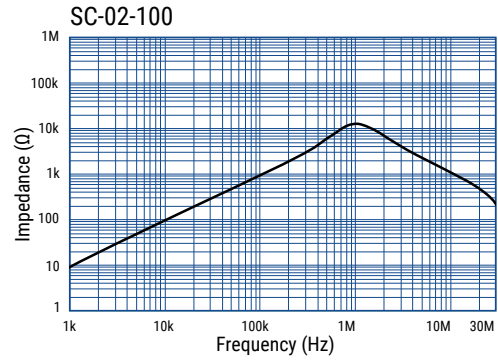
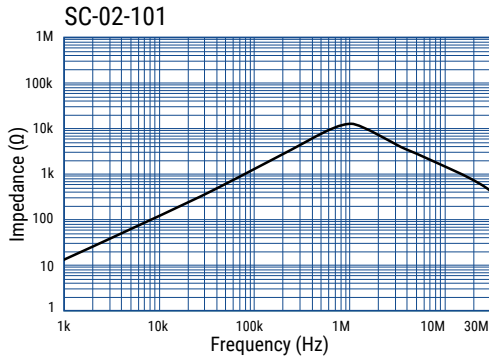

Frequency Characteristics cont.

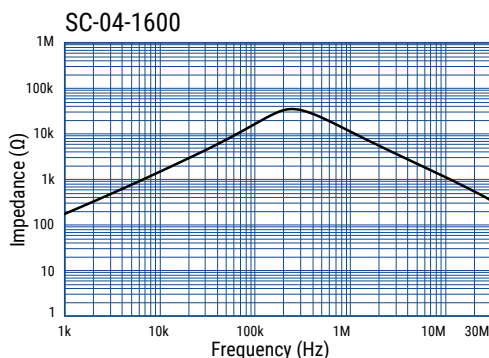
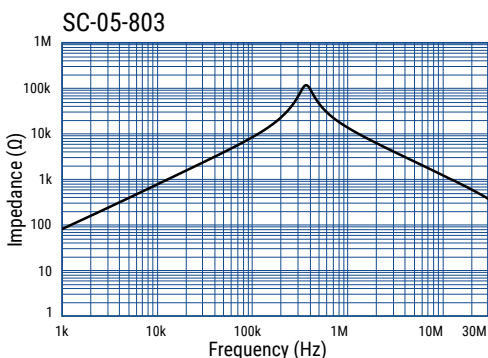
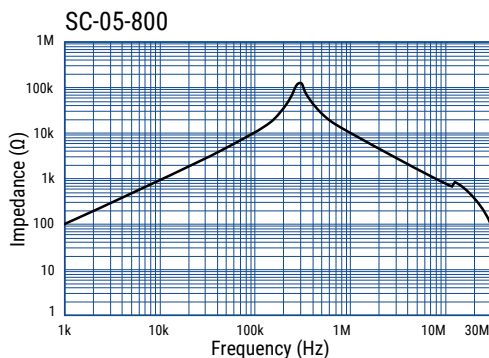
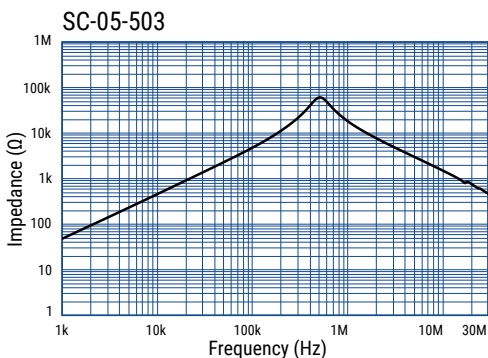
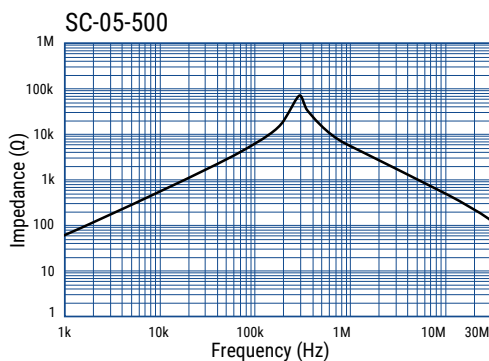
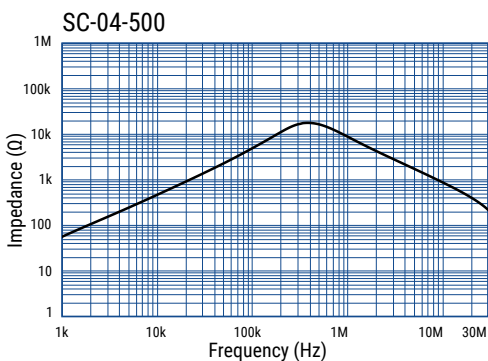
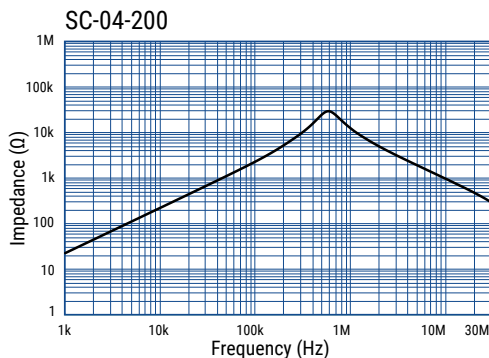
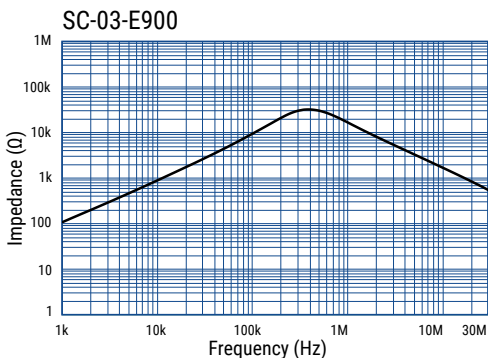

Frequency Characteristics cont.

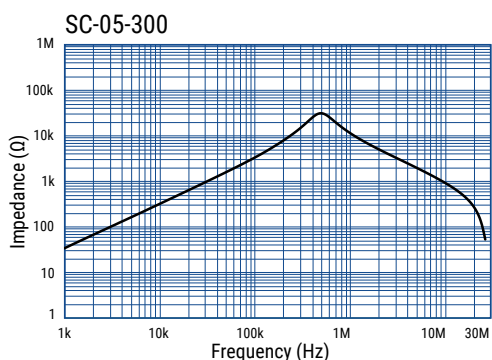
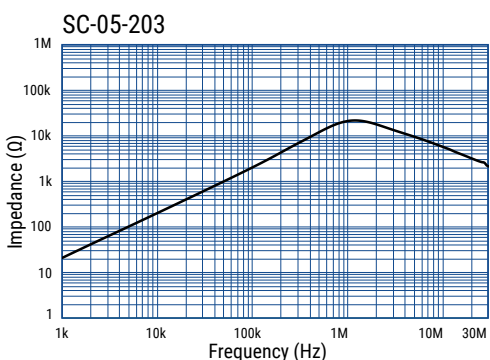
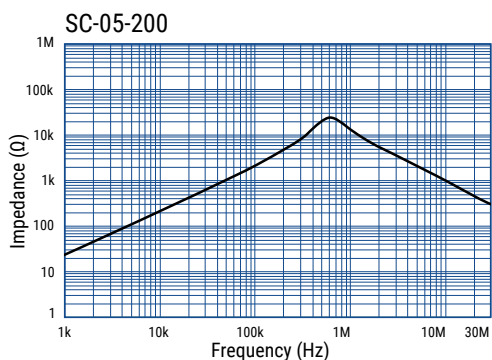
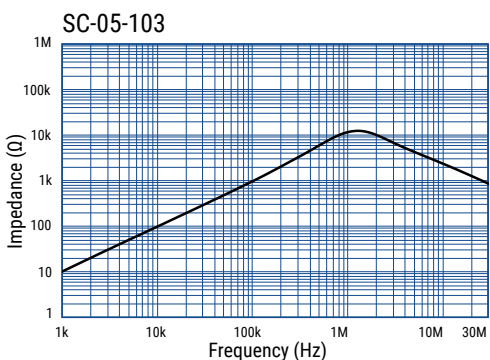
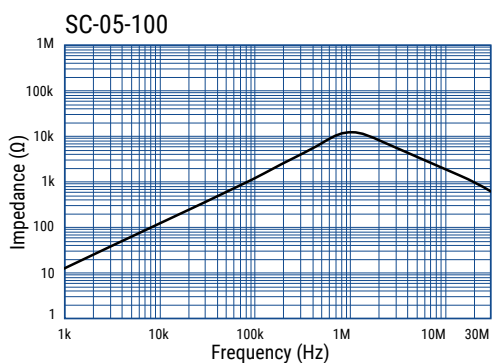
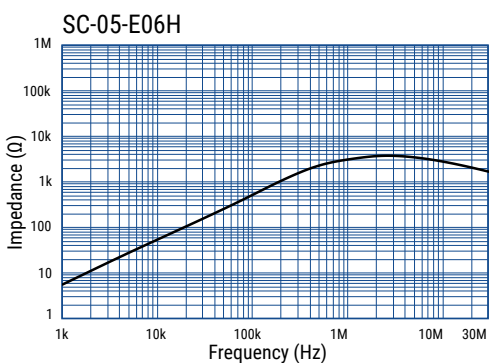
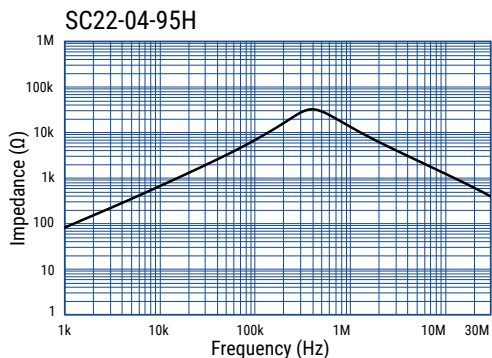
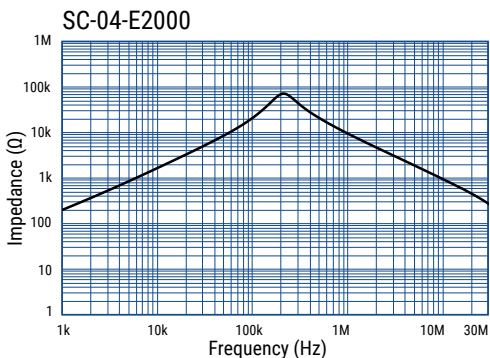

Frequency Characteristics cont.

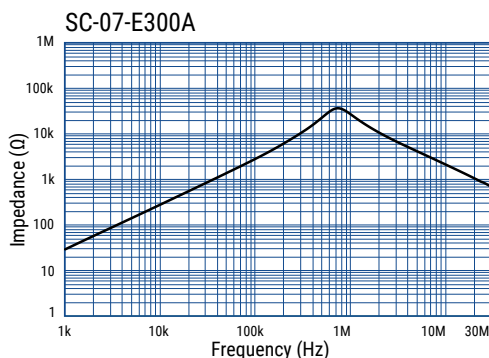
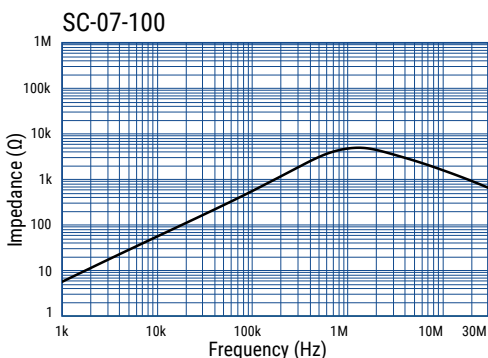
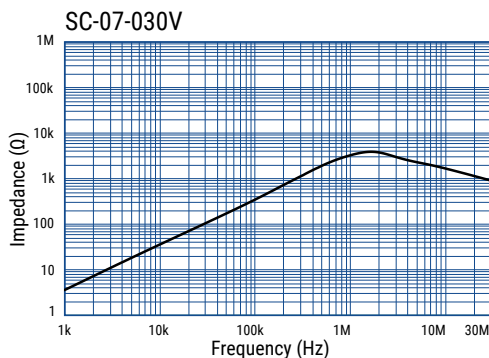
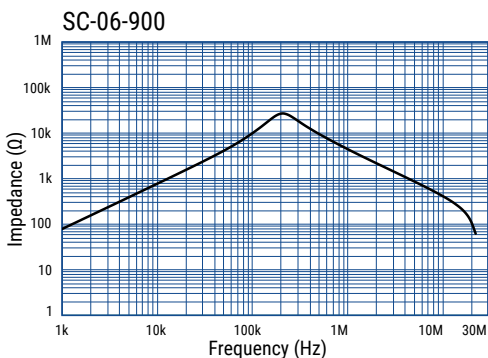
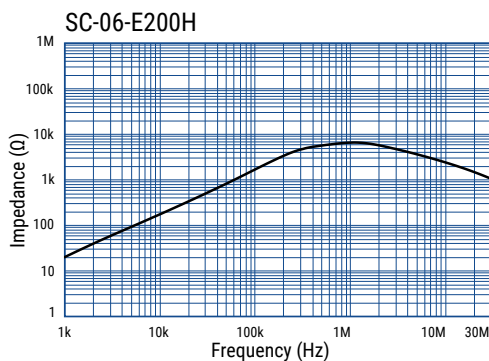
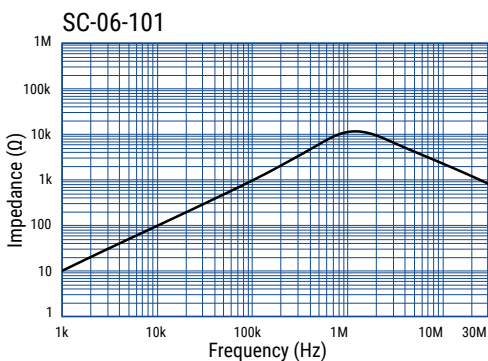
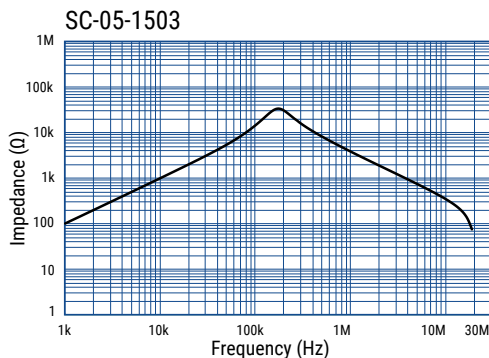
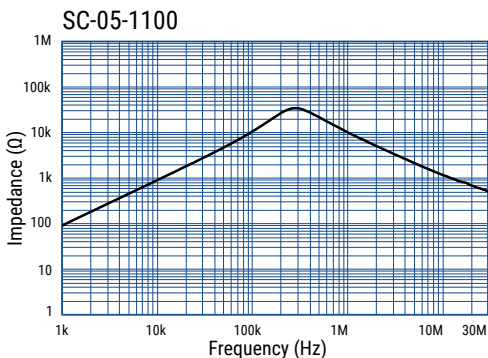

Frequency Characteristics cont.

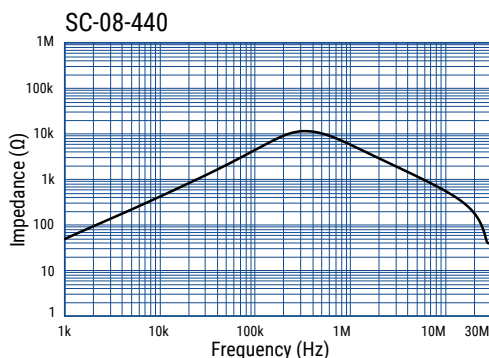
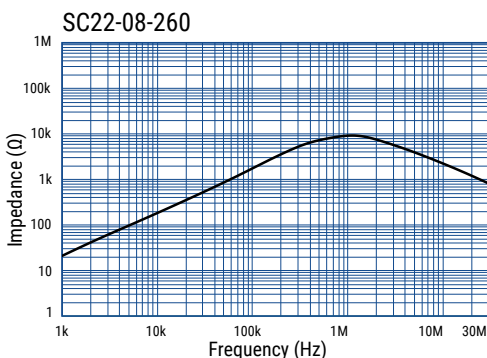
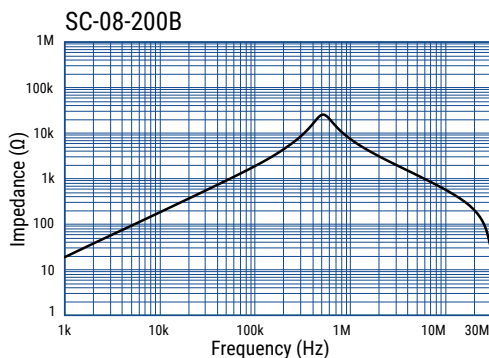
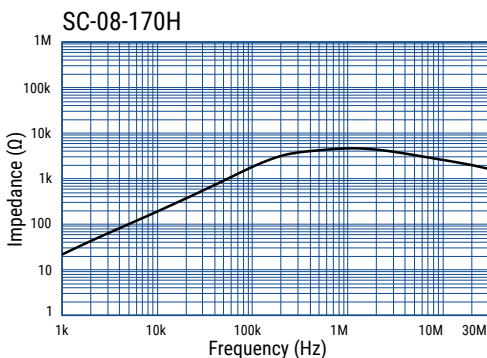
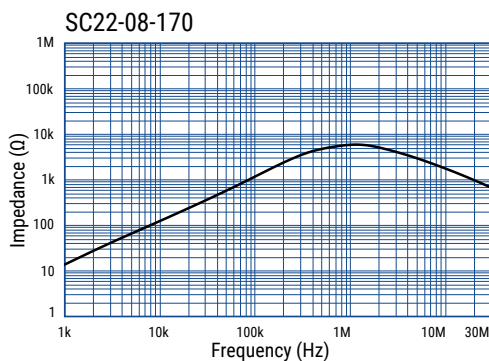
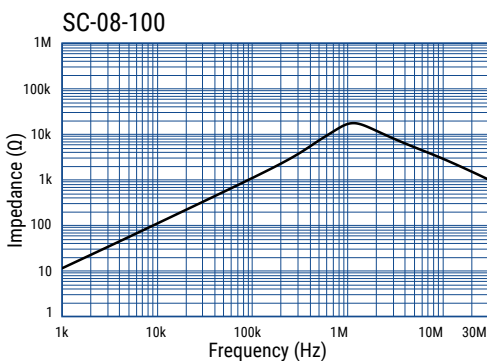
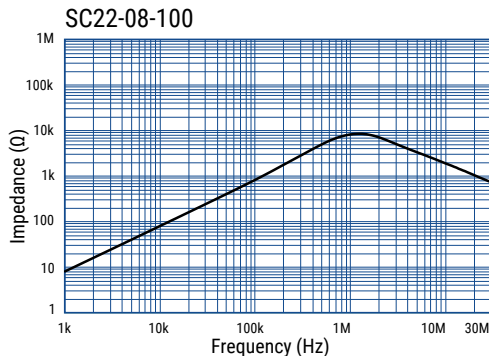
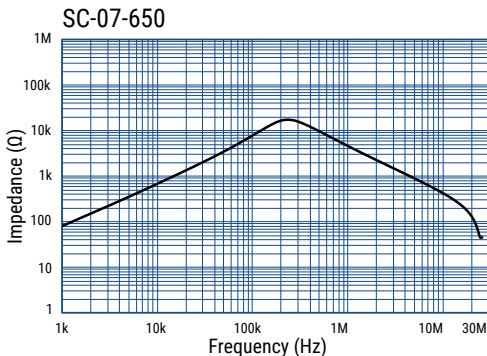

Frequency Characteristics cont.

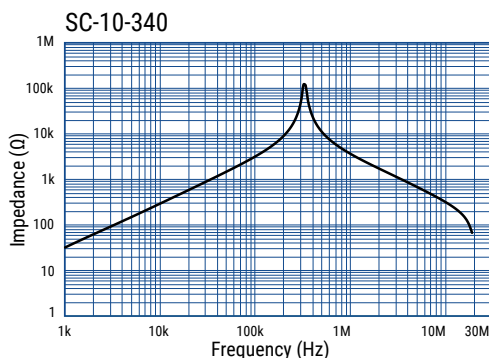
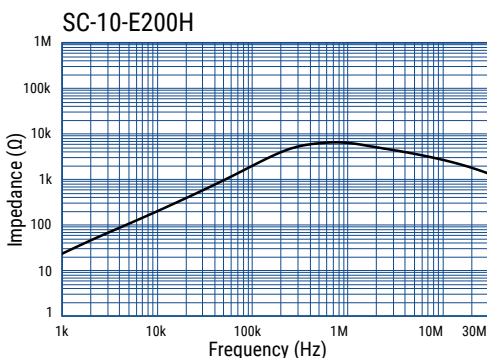
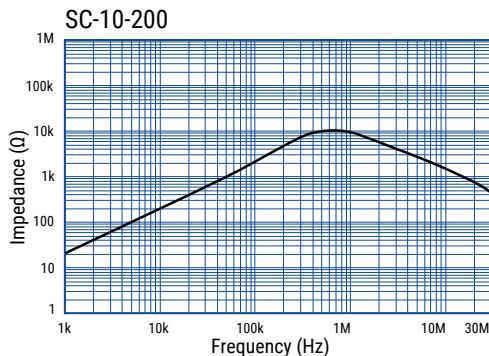
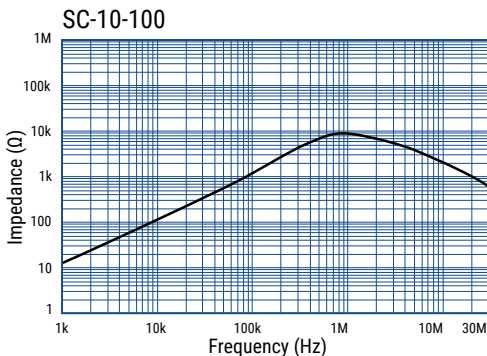
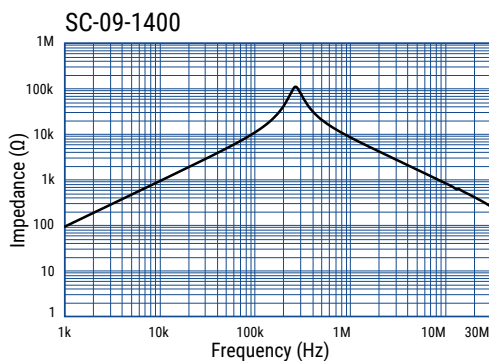
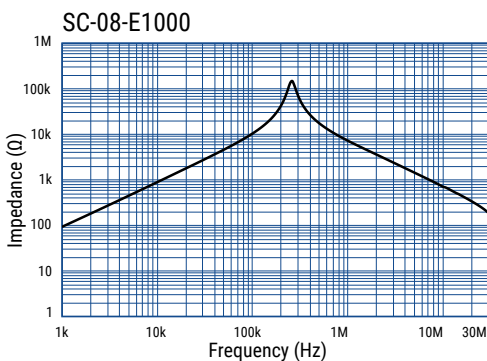
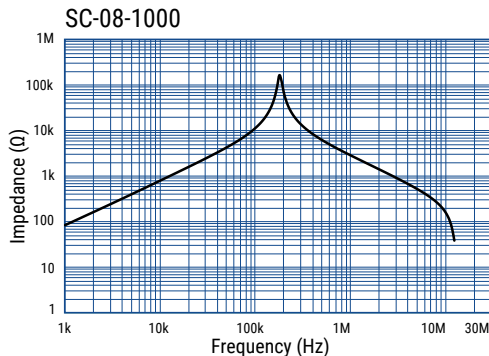
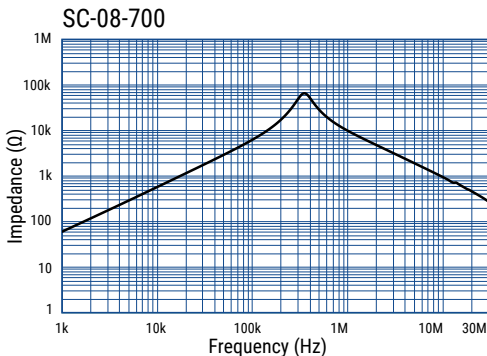

Frequency Characteristics cont.

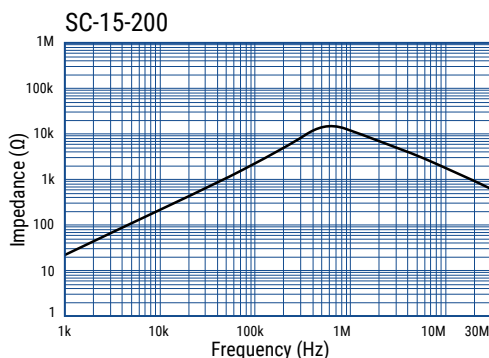
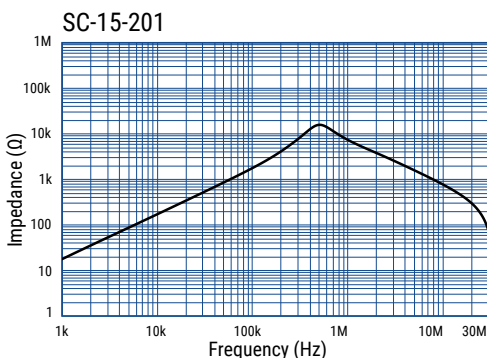
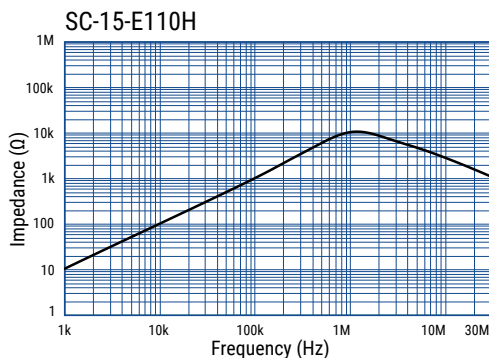
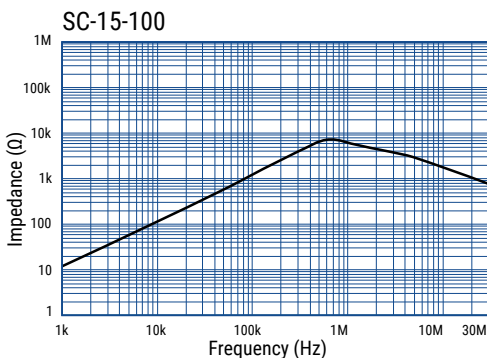
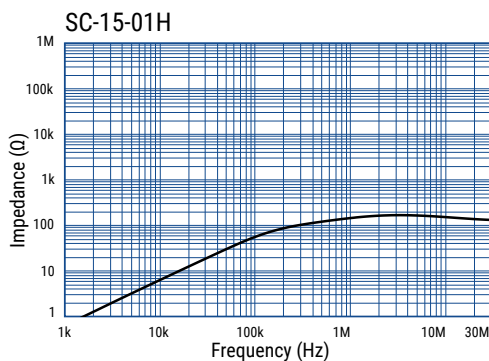
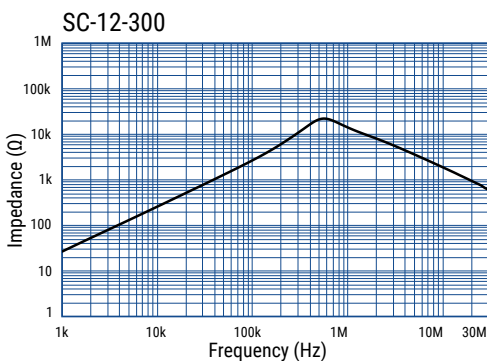
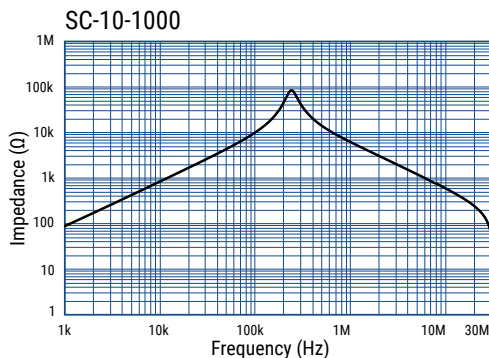
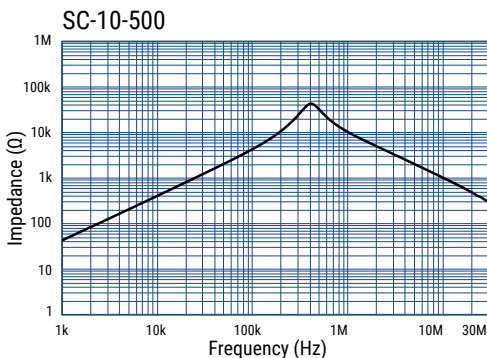

Frequency Characteristics cont.

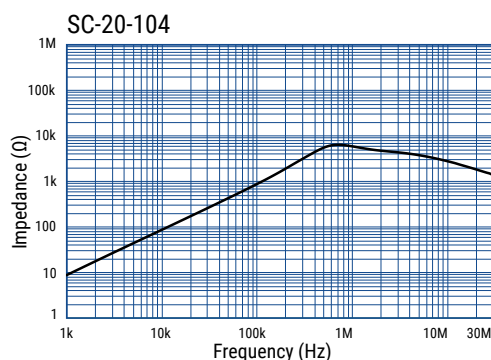
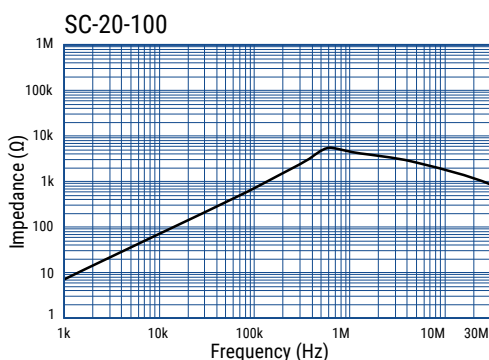
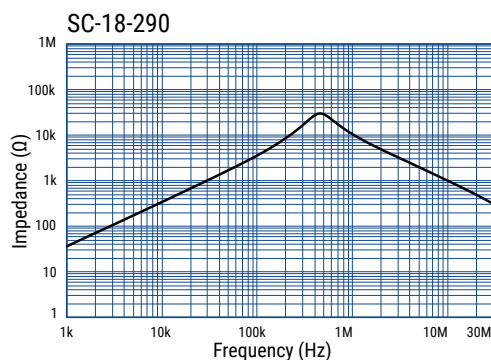
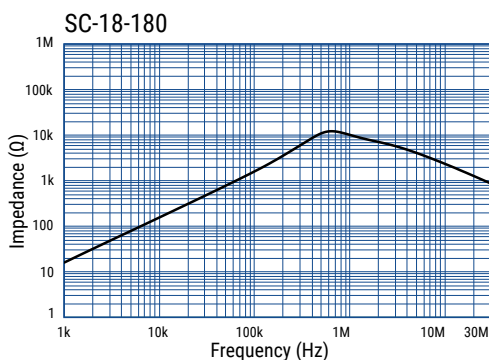
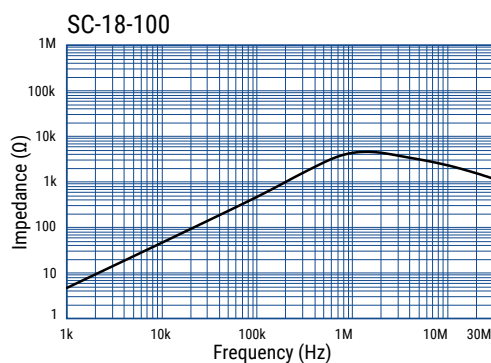
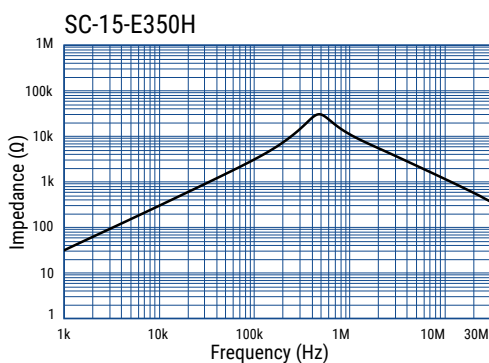
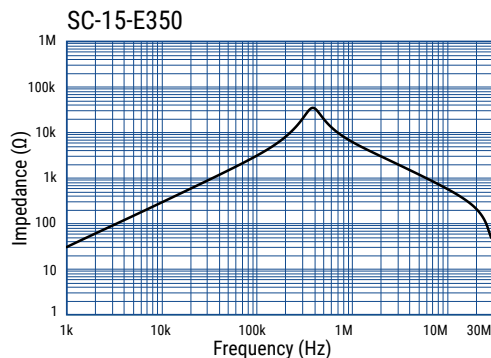
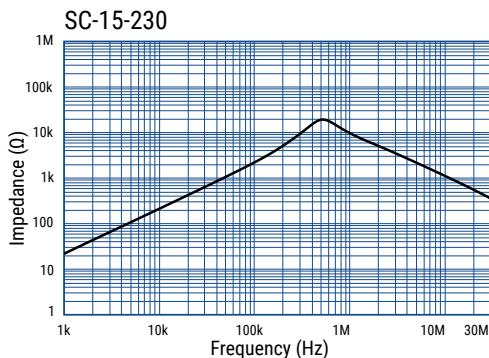

Frequency Characteristics cont.

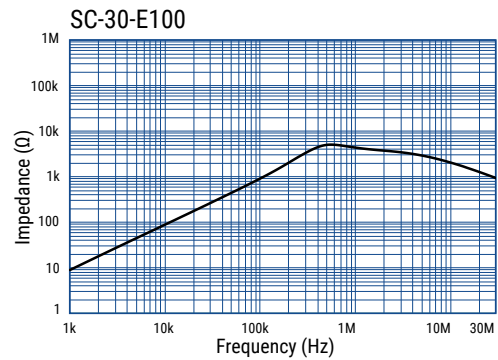
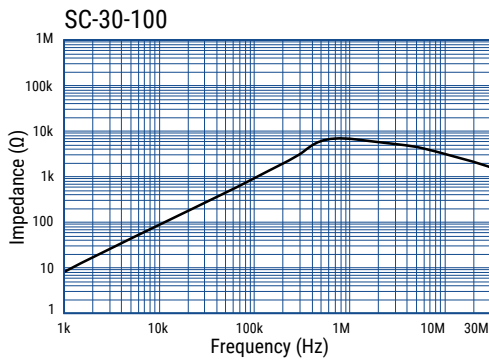
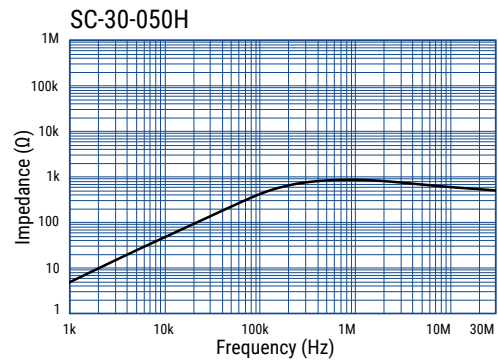
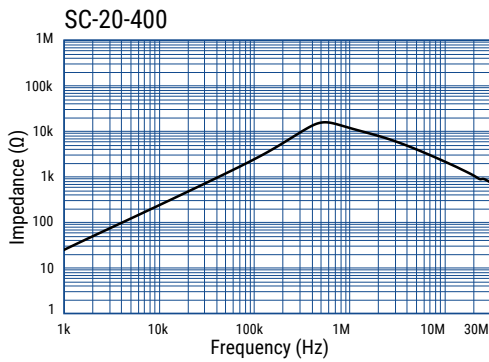
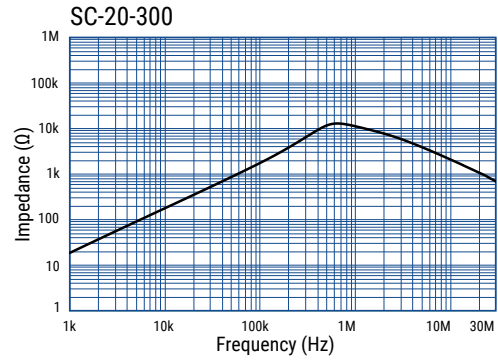
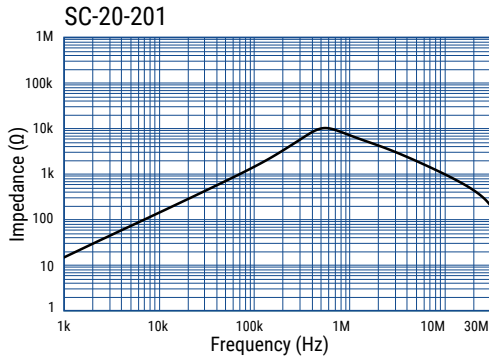

Packaging

Type	Packaging Type	Pieces Per Box	
SC-02-101	Tray	360	
SC-02-100		300	
SC-02-200		300	
SC-02-300			
SC-02-500		500	
SC-02-E620H			
SC-02-800		200	
SC-02-090		360	
SC-03-E900		300	
SC-04-200			
SC-04-500		200	
SC-05-500			
SC-05-503			
SC-05-800			
SC-05-803			
SC-04-1600			
SC-04-E2000			100
SC22-04-95H			200
SC-05-E06H			300
SC-05-100			500
SC-05-103		200	
SC-05-200			
SC-05-203			
SC-05-300		120	
SC-05-1100			
SC-05-1503		200	
SC-06-101		500	
SC-06-E200H			
SC-06-900		200	
SC-07-030V		300	
SC-07-100			
SC-07-E300A		200	
SC-07-650			
SC22-08-100	250		
SC-08-100	200		

Type	Packaging Type	Pieces Per Box
SC22-08-170	Tray	250
SC-08-170H		150
SC-08-200B		200
SC22-08-260		500
SC-08-440		200
SC-08-700		60
SC-08-1000		
SC-08-E1000		40
SC-09-1400		
SC-10-100		200
SC-10-200		90
SC-10-E200H		150
SC-10-340		60
SC-10-500		90
SC-10-1000		60
SC-12-300		90
SC-15-01H		300
SC-15-100		90
SC-15-E110H		150
SC-15-201		60
SC-15-200		90
SC-15-230		
SC-15-E350		60
SC-15-E350H		90
SC-18-100		160
SC-18-180		90
SC-18-290		200
SC-20-100		60
SC-20-104		90
SC-20-201		60
SC-20-300		
SC-20-400		90
SC-30-050H		
SC-30-100	60	
SC-30-E100		

Handling Precautions

Precautions for product storage

AC Line Filters should be stored in normal working environments. While the chokes themselves are quite robust in other environments, solderability will be degraded by exposure to high temperatures, high humidity, corrosive atmospheres, and long term storage.

KEMET recommends that maximum storage temperature not exceed 40°C and maximum storage humidity not exceed 70% relative humidity. Atmospheres should be free of chlorine and sulfur bearing compounds. Temperature fluctuations should be minimized to avoid condensation on the parts. Avoid storage near strong magnetic fields, as this might magnetize the product.

For optimized solderability, AC line filters stock should be used promptly and preferably within 6 months of receipt.

Product temperature rise values

The values listed for temperature rise are the result of self-heating in wires when the rated current (commercial frequency) is applied.

When using the product, check and evaluate the value of the core temperature rise under actual operating conditions.

KEMET Electronics Corporation Sales Offices

For a complete list of our global sales offices, please visit www.kemet.com/sales.

Disclaimer

YAGEO Corporation and its affiliates do not recommend the use of commercial or automotive grade products for high reliability applications or manned space flight.

All product specifications, statements, information and data (collectively, the "Information") in this datasheet are subject to change. The customer is responsible for checking and verifying the extent to which the Information contained in this publication is applicable to an order at the time the order is placed. All Information given herein is believed to be accurate and reliable, but it is presented without guarantee, warranty, or responsibility of any kind, expressed or implied.

Statements of suitability for certain applications are based on KEMET Electronics Corporation's ("KEMET") knowledge of typical operating conditions for such applications, but are not intended to constitute – and KEMET specifically disclaims – any warranty concerning suitability for a specific customer application or use. The Information is intended for use only by customers who have the requisite experience and capability to determine the correct products for their application. Any technical advice inferred from this Information or otherwise provided by KEMET with reference to the use of KEMET's products is given gratis, and KEMET assumes no obligation or liability for the advice given or results obtained.

Although KEMET designs and manufactures its products to the most stringent quality and safety standards, given the current state of the art, isolated component failures may still occur. Accordingly, customer applications which require a high degree of reliability or safety should employ suitable designs or other safeguards (such as installation of protective circuitry or redundancies) in order to ensure that the failure of an electrical component does not result in a risk of personal injury or property damage.

Although all product-related warnings, cautions and notes must be observed, the customer should not assume that all safety measures are indicated or that other measures may not be required.

When providing KEMET products and technologies contained herein to other countries, the customer must abide by the procedures and provisions stipulated in all applicable export laws and regulations, including without limitation the International Traffic in Arms Regulations (ITAR), the US Export Administration Regulations (EAR) and the Japan Foreign Exchange and Foreign Trade Act.

KEMET is a registered trademark of KEMET Electronics Corporation.

OUR CERTIFICATE

DiGi provide top-quality products and perfect service for customer worldwide through standardization, technological innovation and continuous improvement. DiGi through third-party certification, we strictly control the quality of products and services. Welcome your RFQ to

Email: Info@DiGi-Electronics.com



Tel: +00 852-30501935

RFQ Email: Info@DiGi-Electronics.com

DiGi is a global authorized distributor of electronic components.