

T510X477M006AS Datasheet



<https://www.DiGi-Electronics.com>

DiGi Electronics Part Number	T510X477M006AS-DG
Manufacturer	KEMET
Manufacturer Product Number	T510X477M006AS
Description	CAP TANT 470UF 20% 6.3V 2917
Detailed Description	470 μ F Molded Tantalum Capacitors 6.3 V 2917 (7343 Metric) 30mOhm

This model T510X477M006AS is available at DiGi Electronics.

DiGi Electronics offers a global database of semiconductor and electronic component datasheets.

We welcome your inquiries regarding pricing, lead time, or other product-related questions.

 [Request a Quote](#)

 [Datasheet Search](#)



Tel: +00 852-30501935

RFQ Email: Info@DiGi-Electronics.com

DiGi is a global authorized distributor of electronic components.

Purchase and inquiry

Manufacturer Product Number:

T510X477M006AS

Series:

T510

Capacitance:

470 μ F

Voltage - Rated:

6.3 V

ESR (Equivalent Series Resistance):

30mOhm

Lifetime @ Temp.:

-

Package / Case:

2917 (7343 Metric)

Height - Seated (Max):

0.169" (4.30mm)

Manufacturer Size Code:

X

Failure Rate:

-

Manufacturer:

KEMET

Product Status:

Obsolete

Tolerance:

\pm 20%

Type:

Molded

Operating Temperature:

-55°C ~ 125°C

Mounting Type:

Surface Mount

Size / Dimension:

0.287" L x 0.169" W (7.30mm x 4.30mm)

Lead Spacing:

-

Features:

General Purpose

Environmental & Export classification

RoHS Status:

RoHS non-compliant

REACH Status:

REACH Unaffected

HTSUS:

8532.21.0050

Moisture Sensitivity Level (MSL):

1 (Unlimited)

ECCN:

EAR99

FEATURES

- Ultra Low ESR < 30 mΩ
- New E/7260 Case with ESR < 18 mΩ
- Up to 4 Amps ripple current
- 100% accelerated steady-state aging
- 100% Surge current test
- Precision - molded, laser-marked case
- Symmetrical compliant terminations
- Taped and reeled per EIA 481-1

OUTLINE DRAWING

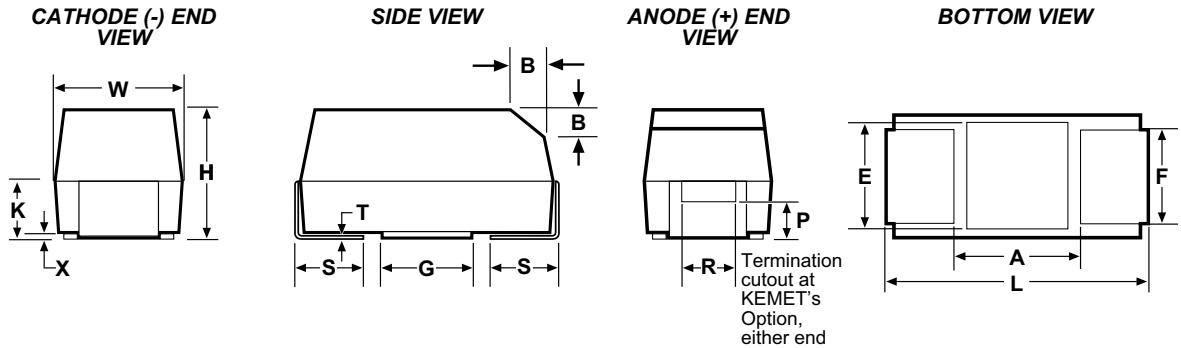

DIMENSIONS - Millimeters (Inches)

CASE SIZE		COMPONENT													
KEMET	EIA	L	W	H	K ± 0.20 ± (.008)	F ± 0.1 ± (.004)	S ± 0.3 ± (.012)	B ± 0.15 (Ref) ± (.006)	X (Ref)	P (Ref)	R (Ref)	T (Ref)	A (Min)	G (Ref)	E (Ref)
X	7343-43	7.3 ± 0.3 (.287 ± .012)	4.3 ± 0.3 (.169 ± .012)	4.0 ± 0.3 (.157 ± .012)	2.3 (.091)	2.4 (.094)	1.3 (.051)	0.5 (.020)	0.10 ± 0.10 (.004 ± .004)	0.9 (.035)	1.0 (.039)	0.13 (.005)	3.8 (.150)	3.5 (.138)	3.5 (.138)
E	7260-38	7.3 ± 0.3 (.287 ± .012)	6.0 ± 0.3 (.236 ± .012)	4.0 ± 0.3 (.157 ± .012)	2.3 (.091)	2.4 (.094)	1.3 (.051)	0.5 (.020)	0.10 ± 0.10 (.004 ± .004)	0.9 (.035)	1.0 (.039)	0.13 (.005)	3.8 (.150)	3.5 (.138)	3.5 (.138)

Notes: Metric Dimensions govern
(Ref) - Dimensions provided for reference only.

T510 RATINGS & PART NUMBER REFERENCE

Capacitance μF	Case Size	KEMET Part Number	DC Leakage μA @ 25°C Max	DF % @ 25°C Max	ESR m W @ 25°C 100 kHz Max	Ripple Current A rms @ 25°C 100 kHz, max		
						25°C	85°C	125°C
4 Volt Rating at +85°C (2.7 Volt Rating at 125°C)								
680.0	X	T510X687(1)004AS	27.2	6.0	30.0	3.0	2.7	1.2
1000.0	E	T510E108(1)004AS	40.0	6.0	18.0	4.0	3.6	1.6
1000.0	E	T510E108(1)004AS4115	40.0	6.0	10.0	5.3	4.8	2.1
6/6.3 Volt Rating at +85°C (4 Volt Rating at 125°C)								
470.0	X	T510X477(1)006AS	28.2	6.0	30.0	3.0	2.7	1.2
680.0	E	T510E687(1)006AS	40.8	6.0	23.0	3.5	3.2	1.4
680.0	E	T510E687(1)006AS4115	40.8	6.0	12.0	4.8	4.3	1.9
10 Volt Rating at +85°C (7 Volt Rating at 125°C)								
330.0	X	T510X337(1)010AS	33.0	6.0	35.0	2.8	2.5	1.1
25 Volt Rating at +85°C (17 Volt Rating at 125°C)								
100.0	E	T510E107(1)025AS	25.0	8.0	50.0	2.4	2.1	1.0

T510 ORDERING INFORMATION

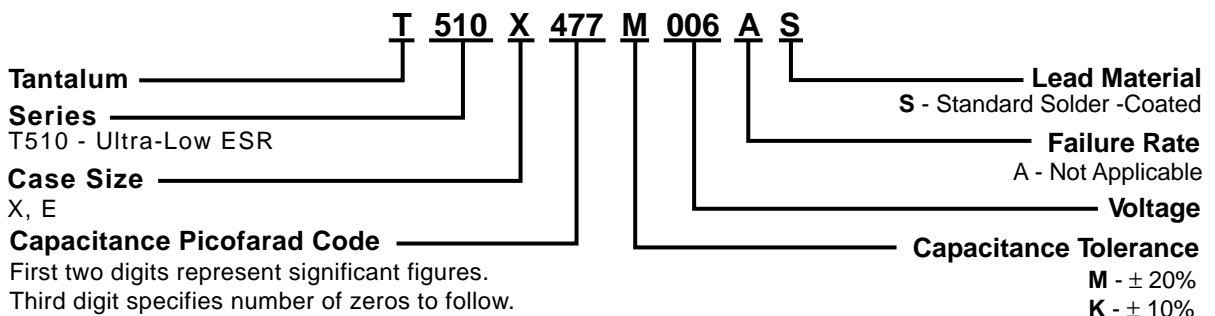

TYPICAL CAP FREQUENCY SCAN @25°C
T510X477M006AS

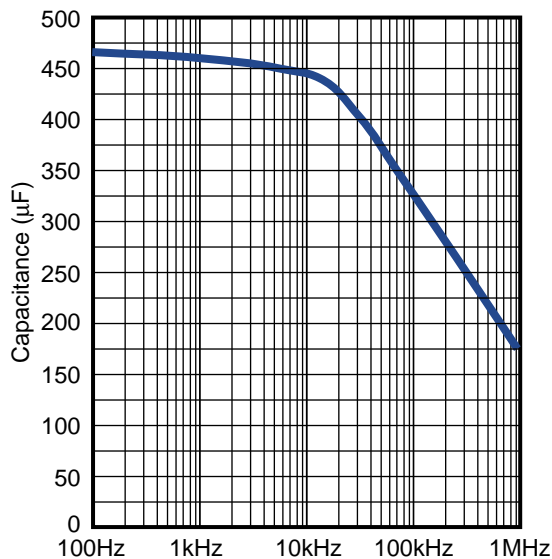

TYPICAL ESR/Z FREQUENCY SCAN @25°C
T510X477M006AS

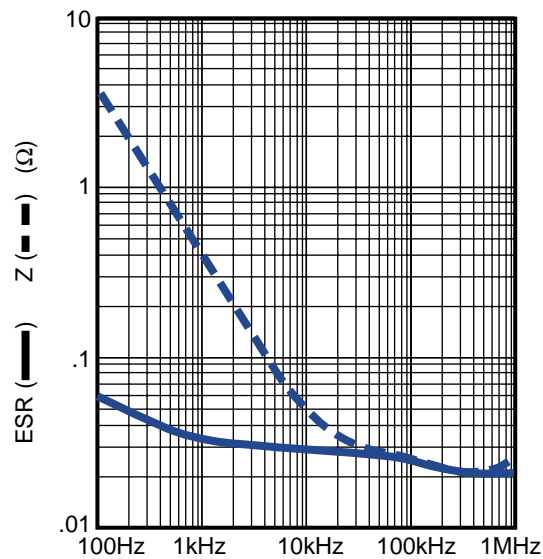

Solid Tantalum Surface Mount

CAPACITOR MARKINGS

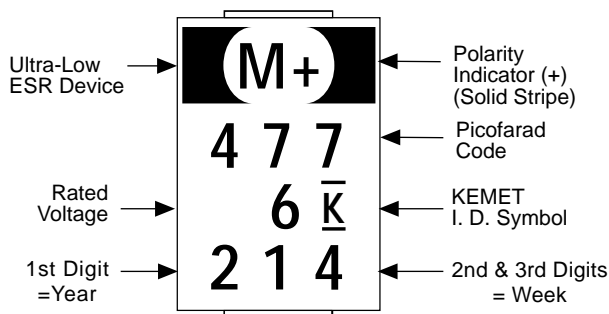

"214" = The 14th week of 2002.

T510 SERIES CONSTRUCTION

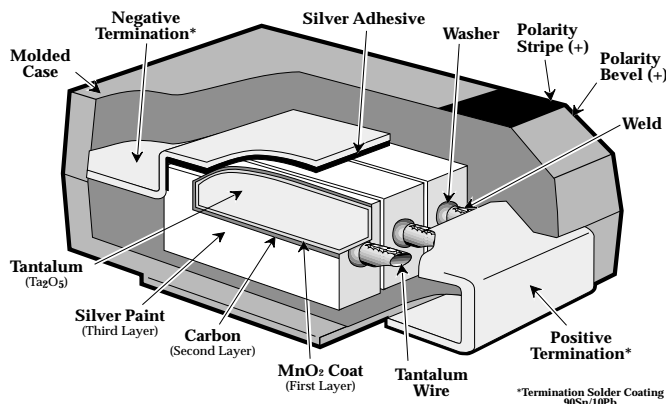

TYPICAL CAP FREQUENCY SCAN @ 25°C
T510E108M004AS

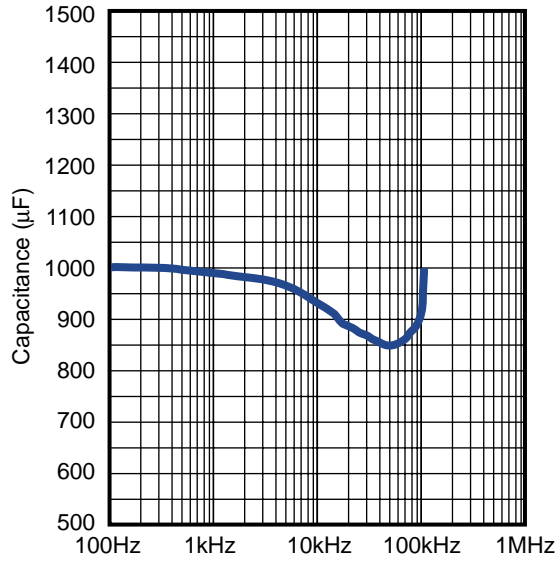

TYPICAL ESR/Z FREQUENCY SCAN @ 25°C
T510E108M004AS

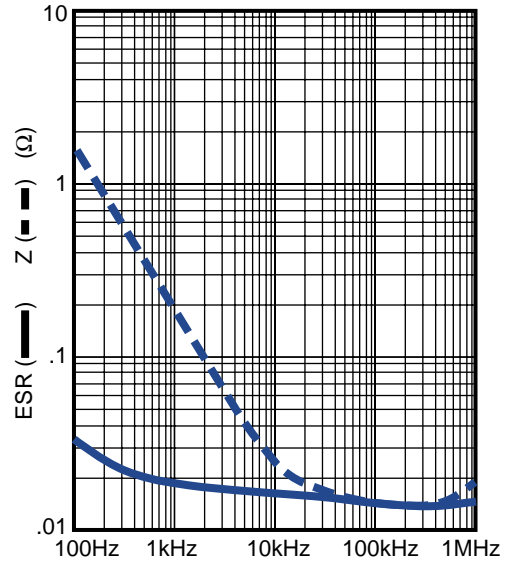

CAPACITOR MARKINGS

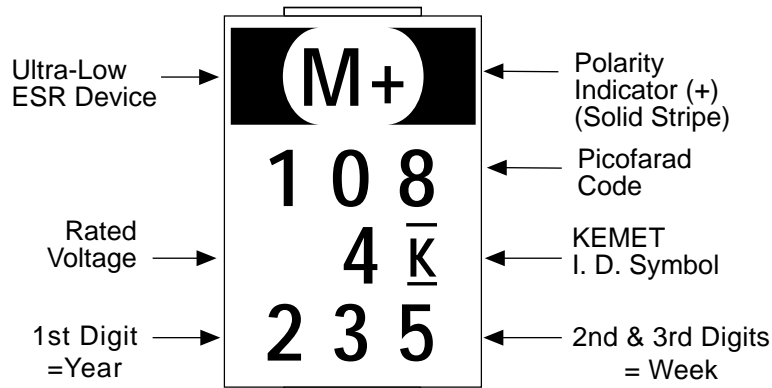

"235" = The 35th week of 2002.

T510E SERIES CONSTRUCTION



OUR CERTIFICATE

DiGi provide top-quality products and perfect service for customer worldwide through standardization, technological innovation and continuous improvement. DiGi through third-party certification, we stricly control the quality of products and services. Welcome your RFQ to

Email: Info@DiGi-Electronics.com



Tel: +00 852-30501935

RFQ Email: Info@DiGi-Electronics.com

DiGi is a global authorized distributor of electronic components.