

0603Y2500620JUT Datasheet

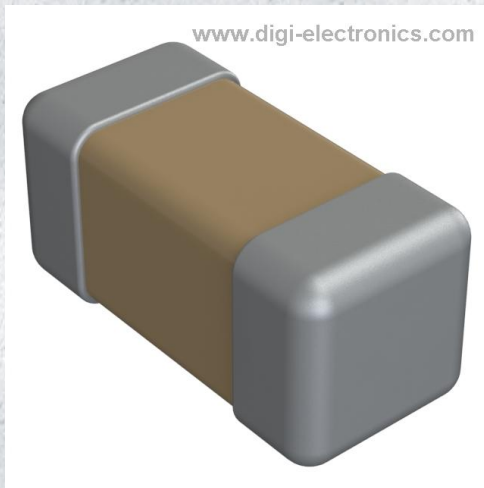

<https://www.DiGi-Electronics.com>

DiGi Electronics Part Number	0603Y2500620JUT-DG
Manufacturer	Knowles Syfer
Manufacturer Product Number	0603Y2500620JUT
Description	CAP CER 62PF 250V COG/NP0 0603
Detailed Description	62 pF ±5% 250V Ceramic Capacitor COG, NP0 (1B) 0603 (1608 Metric)

This model 0603Y2500620JUT is available at DiGi Electronics.

DiGi Electronics offers a global database of semiconductor and electronic component datasheets.

We welcome your inquiries regarding pricing, lead time, or other product-related questions.

 [Request a Quote](#)

 [Datasheet Search](#)



Tel: +00 852-30501935

RFQ Email: Info@DiGi-Electronics.com

DiGi is a global authorized distributor of electronic components.

Purchase and inquiry

Manufacturer Product Number:

0603Y2500620JUT

Series:

FlexiCap™

Capacitance:

62 pF

Voltage - Rated:

250V

Operating Temperature:

-55°C ~ 125°C

Ratings:

-

Failure Rate:

-

Package / Case:

0603 (1608 Metric)

Height - Seated (Max):

-

Lead Spacing:

-

Base Product Number:

0603Y

Manufacturer:

Knowles Syfer

Product Status:

Active

Tolerance:

±5%

Temperature Coefficient:

COG, NP0 (1B)

Features:

High Q, Low Loss, Ultra Low ESR, Soft Termination

Applications:

RF, Microwave, High Frequency, Boardflex Sensitive

Mounting Type:

Surface Mount, MLCC

Size / Dimension:

0.063" L x 0.031" W (1.60mm x 0.80mm)

Thickness (Max):

0.031" (0.80mm)

Lead Style:

-

Environmental & Export classification

RoHS Status:

ROHS3 Compliant

REACH Status:

REACH Unaffected

HTSUS:

8532.24.0020

Moisture Sensitivity Level (MSL):

1 (Unlimited)

ECCN:

EAR99

ESR**"U" range of Ultra-low ESR Capacitors****Ultra-low ESR "U" Range**

The Ultra-low ESR "U" range offers a very stable, High Q material system that provides excellent low loss performance in systems below 3GHz.

Optimised for lowest possible ESR, this range of high frequency capacitors is suitable for many applications where economical, high performance is required.

Cases sizes 0603, 0805 and 1111 are offered with a standard operating temperature range of -55°C to +125°C. 1111 parts are also available with an extended temperature range of -55°C to +175°C, by adding suffix H17.

Electrical Details	
Capacitance Range	0.2pF to 2.2nF
Temperature Coefficient of Capacitance (TCC)	0 ± 30ppm/°C (COG)
Q factor	>2000 @ 1MHz
Insulation Resistance (IR)	100GΩ or 1000secs (whichever is less)
Dielectric Withstand Voltage (DWV)	Voltage applied for 5 seconds maximum at 50mA maximum charging current
Operating temperature range	-55°C / +125°C (non-suffixed parts) -55°C / +175°C (H17 suffixed parts)
Ageing Rate	Zero

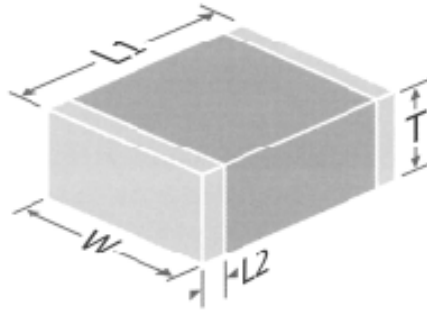

Size	Length mm (L1)	Width mm (W)	Thickness mm (T)	Band mm (L2)
0603	1.6 ± 0.2	0.8 ± 0.2	0.8 Max	0.20 - 0.40
0805	2.0 ± 0.3	1.25 ± 0.2	1.3 Max	0.25 - 0.75
1111	2.79 +0.51/-0.25	2.79 ± 0.38	2.0±0.2*	0.13 - 0.63

* 1111 capacitance values < 2.2pF, maximum thickness 1.78mm

Ordering Information – Ultra-low ESR "U" Range

0805	J	250	0101	J	U	T	Suffix
Chip Size	Termination	Voltage d.c. (marking code)	Capacitance in Pico farads (pF)	Capacitance Tolerance	Dielectric	Packaging	
0603	J = Nickel barrier, 100% tin plating (RoHS compliant)	100 = 100V	<1.0pF	<10pF	U = Ultra-low ESR "U" range	T = 178mm (7") reel	None = -55/+125°C temperature range
0805		200 = 200V	Insert a P for the decimal point as the first character. e.g., P300 = 0.3pF	H: ± 0.05pF B: ± 0.10pF C: ± 0.25pF D: ± 0.5pF		R = 330mm (13") reel	
1111		250 = 250V	e.g., P300 = 0.3pF Values in 0.1pF steps	C: ± 0.25pF D: ± 0.5pF			
	A = Nickel barrier, tin/lead plating (Min 10% lead, non RoHS)	300 = 300V	≥1.0pF & <10pF	≥10pF		B = Bulk pack - tubs or trays	H17 = -55/+175°C temperature range*
		500 = 500V	Insert a P for the decimal point as the second character.	F: ± 1% G: ± 2% J: ± 5% K: ± 10%			
		630 = 630V	e.g., 8P20 = 8.2pF Values are E24 series				
	6 = Nickel Barrier, tin/lead plating (5-20% lead, non RoHS)	1K0 = 1000V	≥10pF				
		1K5 = 1500V	First digit is 0. Second and third digits are significant figures of capacitance code. The fourth digit is the number of zeros following. e.g., 0101 = 100 pF				
		2K0 = 2000V	Values are E24 series				

*H17 suffixed parts are available in case size 1111 only

Knowles Precision Devices Sales contact e-mail	Europe:	KPD-Europe-sales@knowles.com
	Asia:	KPD-Asia-sales@knowles.com
	USA:	KPD-NA-sales@knowles.com

Minimum/Maximum Capacitance Values – “U” range of Ultra-low ESR Capacitors

Note: Knowles Precision Devices operate a continuous improvement process with ranges being expanded and updated regularly. The latest range may differ and is shown on the KPD website – www.knowlescapacitors.com

Chip Size	0603	0805	1111 (no suffix code)	1111 (H17 suffix code)
Temperature range	-55/+125°C			-55/+175°C
Min Cap	0.2pF	0.2pF	0.4pF	2.2pF
100V	-	-	2.2nF	1.0nF
150V	-	-	1.5nF	-
200V/250V	100pF	240pF	1.0nF	-
300V	-	-	680pF	-
500V	-	-	560pF	-
630V	-	-	470pF	470pF
1000V	-	-	220pF	220pF
1500V	-	-	100pF	-
2000V	-	-	68pF	-
Tape Quantities	7" reel – 4,000	7" reel – 3,000	7" reel – 1,000	7" reel – 1,000
	13" reel – 16,000	13" reel – 12,000	13" reel – 5,000	13" reel – 5,000

- Below 1pF capacitance values are available in 0.1pF steps.
- Above 1pF capacitance values are available in E24 series values.
- Other values and taping quantities may be available on request, consult Sales Office for details.
- For values < 0.3pF please consult the Sales Office for availability.

Detailed individual datasheets and part specific environmental certificates can be downloaded direct from the KPD website – www.knowlescapacitors.com

Certificate of RoHS Compliance, REACH Compliance and WEEE Statement	
Part Number: 1111J1K00201FUT	Description: 1111 1000V 200pF ±1% COG - HI Q/Ultra-Low ESR

EU RoHS
Knowles hereby certifies that the part number stated on this certificate complies with the legislative requirements as defined in the RoHS Directive 2011/65/EU (as amended by 2015/863/EU).
There are no exemptions used on these parts to achieve compliance.

China RoHS
In line with the requirements of China RoHS, the hazardous substances table is shown below. In line with the legislative requirements, Knowles will supply a copy of this hazardous substance table with each shipment of product.

Hazardous Substances 有害物质					
Lead (Pb) 铅	Mercury (Hg) 汞	Cadmium (Cd) 镉	Hexavalent Chromium (Cr(VI)) 六价铬	Polybrominated biphenyls (PBB) 多溴联苯	Polybrominated diphenyl ethers (PBDE) 多溴二苯醚
○	○	○	○	○	○

本表格依据SJ/T 11364 的规定编制 This table is prepared in accordance with the provisions of SJ/T11364
○ : 表示该有害物质在该部件所有均质材料中的含量均在GB/T 26572 规定的限量要求以下。
○ : Indicates that said hazardous substance contained in all of the homogeneous materials for this part is below the limit requirement of GB/T 26572.
× : 表示该有害物质至少在该部件的某一均质材料中的含量超出GB/T 26572 规定的限量要求。
× : Indicates that said hazardous substance contained in at least one of the homogeneous materials used for this part is above the limit requirement of GB/T 26572.

EU REACH
The above part does not contain any of the 181 REACH SVHC as listed in the current candidate list, date effective as below.

Knowles Precision Devices - Sales Europe: KPN-KC-CS@knowles.com Asia: KPD-Asia-sales@knowles.com USA: KPD-NA-sales@knowles.com www.knowlescapacitors.com	Date is correct to the best of our knowledge, errors and omissions excepted. Date: Tuesday, September 11, 2018
--	---

Multilayer Ceramic Chip Capacitor	
Part Number: 1111J1K00201FUT	Description: 1111 1000V 200pF ±1% COG - HI Q/Ultra-Low ESR

Ultra stable HighQ Low ESR multi-layer ceramic capacitors offering a very stable COG High Q material system that provides excellent low loss performance. Optimised for lowest possible ESR, the electrode system provides low metal losses, resulting in flatter performance curves and reduced losses at higher frequencies.

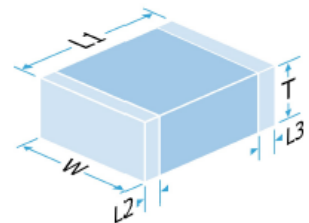

Mechanical Specification	
Size Code	1111
Length (L1) in mm (")	2.79 +0.51/-0.25 (0.11 +0.02/-0.01)
Width (W) in mm (")	2.79 ± 0.38 (0.113 ± 0.015)
Thickness (T) in mm (")	2.2 Max (0.087 Max)
Minimum Termination Band (L2,L3) in mm (")	0.13 (0.005)
Maximum Termination Band (L2,L3) in mm (")	0.63 (0.025)
Termination Material	Nickel Barrier, Sn Plated Solder (RoHS compliant)
Solderability	IEC-60068-2-58
RoHS Compliant to 2011/65/EC as amended by 2015/863/EU	Compliant
REACH Compliant	Compliant
Packaging	7" Reel Horizontal Orientation, 1000 per reel

General Electrical Specification	
Rated Voltage	1000Vdc
Nominal Capacitance Value	200pF
Capacitance Tolerance	±1%
Tangent of Loss Angle (Tan δ)	±0.0005
Capacitance and Tan δ Test Conditions	1.0Vrms @ 1MHz
Voltage Proof	1500Vdc
(Voltage applied for 5 secs max. @ 50mA max. charge current)	
Min insulation Resistance (IR)	100.00GOhm @ 100Vdc
Dielectric Classification	COG - HI Q/Ultra-Low ESR
Rated Temperature Range	-55°C / +125°C
Maximum Capacitance Change over Temperature Range	No DC Voltage 0±30ppm/°C
Rated DC Voltage	-
Climatic Category (IEC)	55/125/55
Ageing Characteristic	Zero

Knowles Precision Devices - Sales
Europe: KPD-Europe-sales@knowles.com
Asia: KPD-Asia-sales@knowles.com
USA: KPD-NA-sales@knowles.com
www.knowlescapacitors.com

This datasheet is for a standard item and is confirmed valid on the date generated, the latest published data for this part may differ and is available at <http://www.knowlescapacitors.com> or by contacting us.

The information contained on this drawing is confidential and may not be copied in whole or part in any form or disclosed to a third party without the consent of Knowles and any customer mentioned within the specification.

Date is correct to the best of our knowledge, errors and omissions excepted.
Date: Tuesday, September 11, 2018

Typical Performance Curves

0603

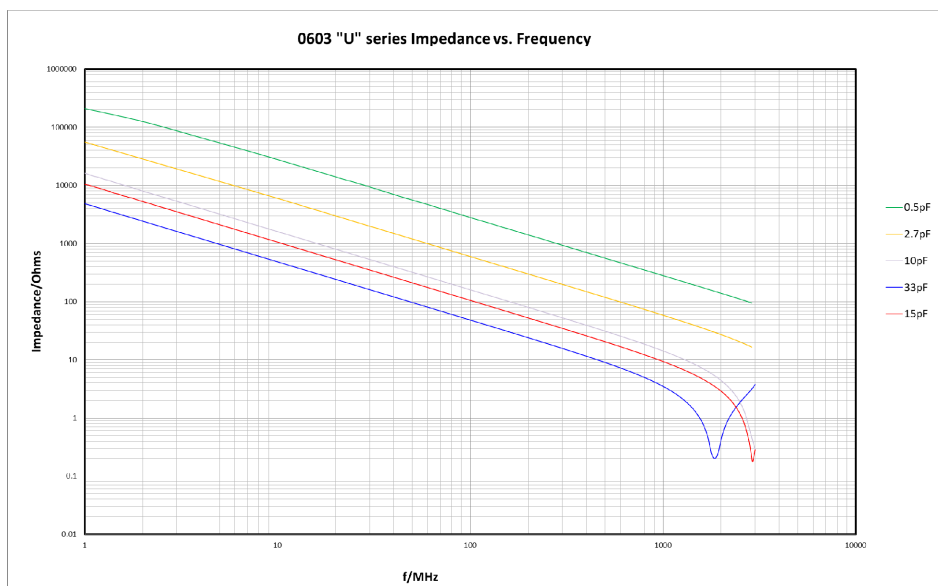
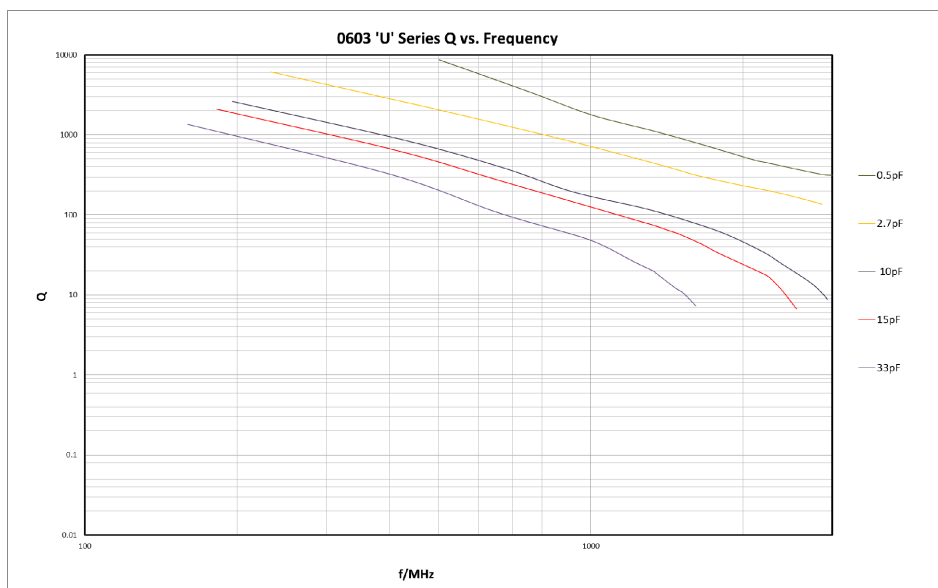
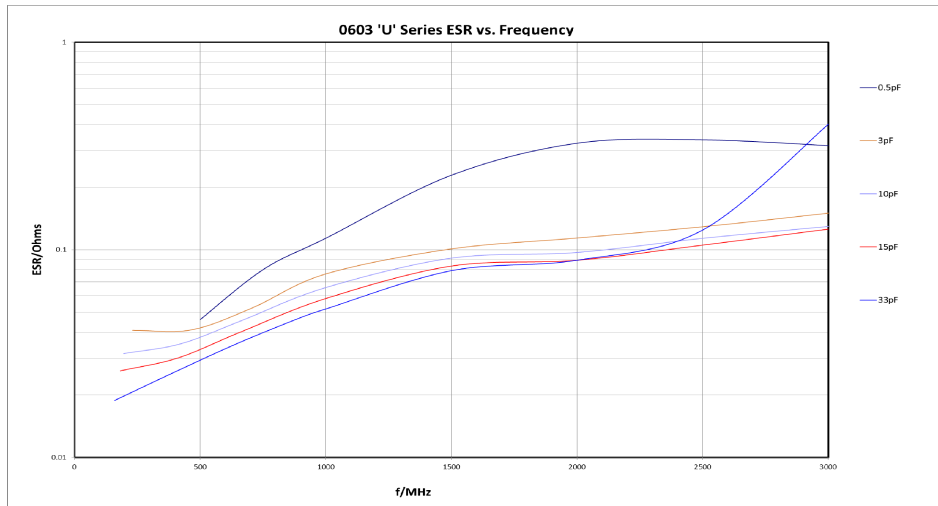

The 0603 "U" range has been modelled by Modelithics Inc. (www.modelithics.com) and scaleable models are available as part of their model libraries for Keysight ADS, Keysight GENESYS, and AWR Microwave Office EDA software.

S parameters for the 0603 are available on both the Modelithics (www.modelithics.com) and Knowles Capacitors website www.knowlescapacitors.com/syfer

0805

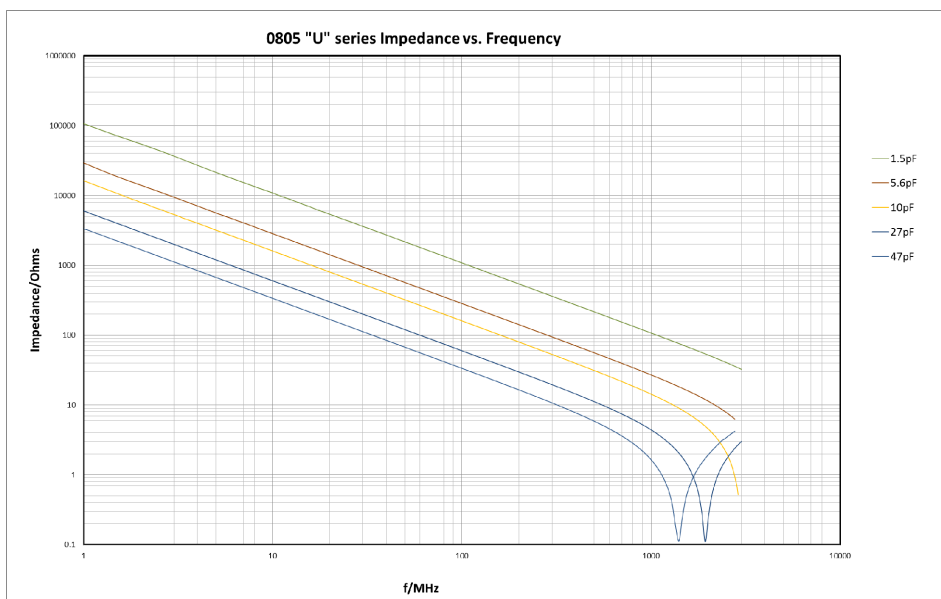
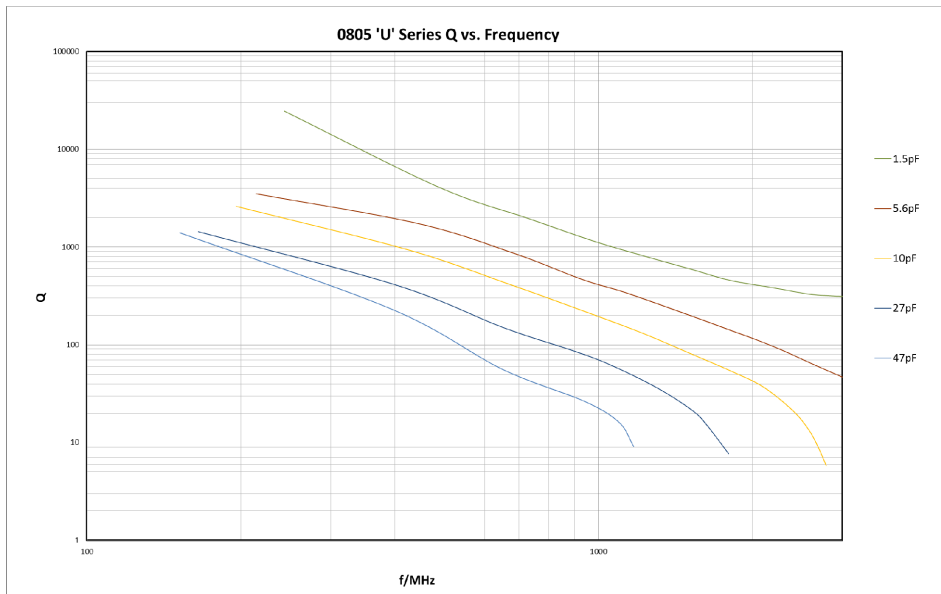
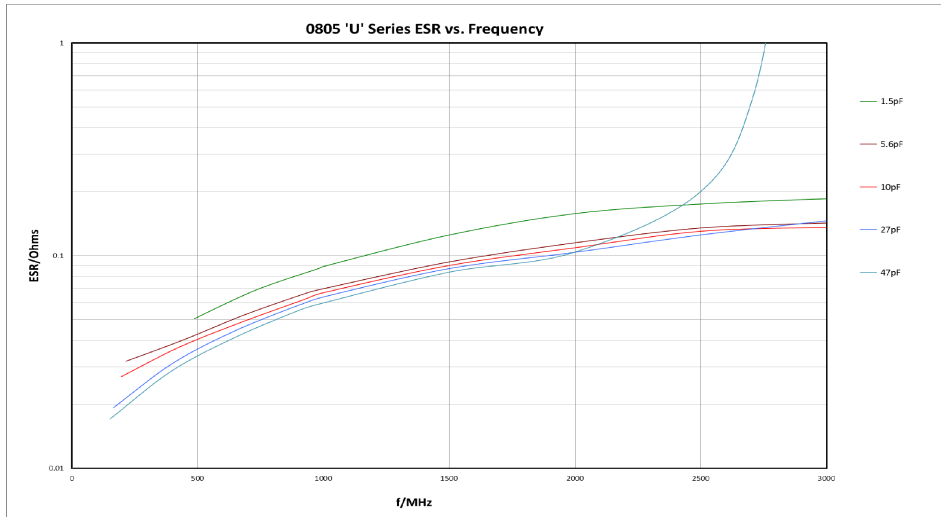

Note curves are typical, based on data measured using a Boonton 34A resonant tube and Keysight E4991 impedance analyser with Keysight 16197A test fixture

Actual performance in circuit may differ and parts should be tested in application.

1111

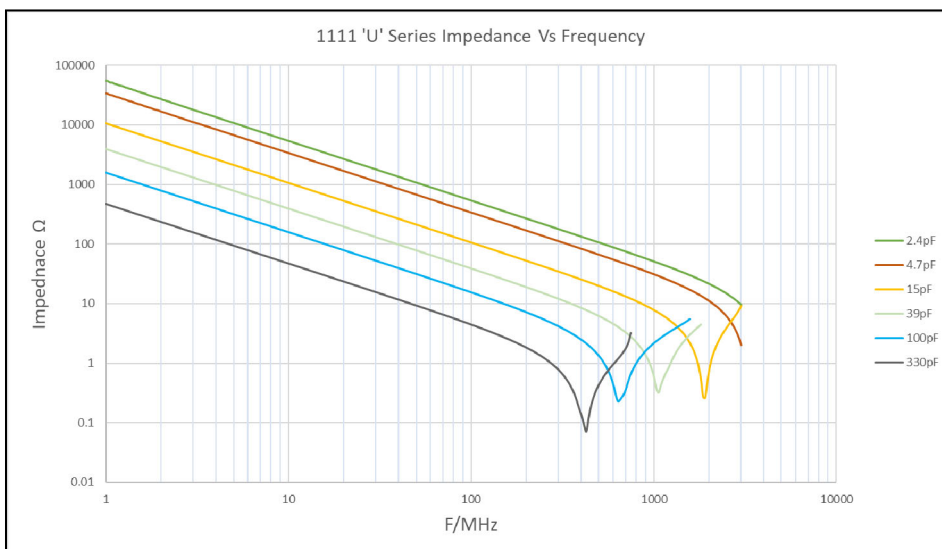
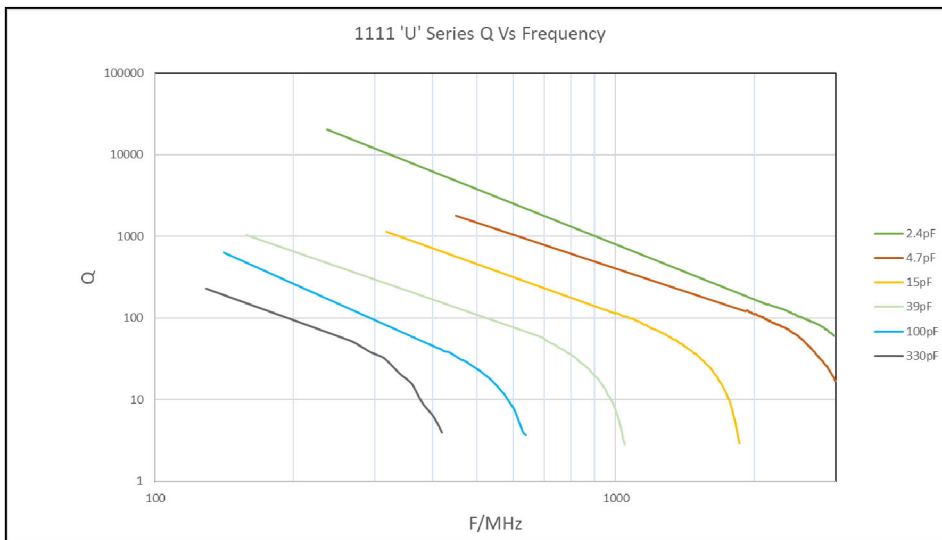
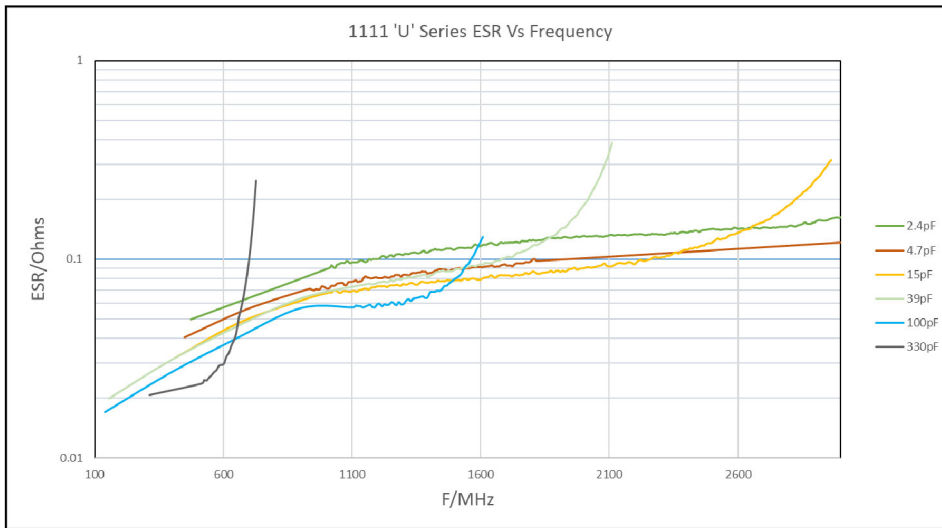

Note curves are typical, based on data measured using a Boonton 34A resonant tube and Keysight E4991 impedance analyser with Keysight 16197A test fixture

Actual performance in circuit may differ and parts should be tested in application.

Performance

Lot by lot inspection (all batches)

Test	Additional Requirements	Sample Size	Accept/Fail	Test Method	
Visual inspection	Inspect construction and workmanship	125	0/1	MIL-STD-883 Method 2009	10x magnification. Free of visual defects
Dimensions	Verify physical dimensions comply with Table 1	13	0/1	JESD22 Method JB-100	Digital Vernier or micrometer as applicable. Within specified tolerance
Capacitance	Class I 1MHz @ 1.0V	100%	N/a	CECC 32 100 Clause 4.6.1	Within specified tolerance
D.F.	Class I 1MHz @ 1.0V	100%	N/a	CECC 32 100 Clause 4.6.2	<0.0005 @ 1MHz (Q > 2000 @ 1MHz)
Voltage Proof (VP) <i>Also known as Dielectric Withstand Voltage (DWV)</i>	R_V (rated voltage) $\leq 200V$ $VP = 2.5 \times R_V$ $200V < R_V < 500V$ $VP = R_V + 250V$ $500V \leq R_V \leq 1kV$ $VP = 1.5 \times R_V$ $1kV < R_V \leq 1.2kV$ $VP = 1.25 \times R_V$ $R_V > 1.2kV$ $VP = 1.2 \times R_V$	100%	N/a	CECC 32 100 Clause 4.6.4	Voltage applied for 5 seconds max at 50mA max charging current No breakdown or flashover. $R \geq 100M\Omega$ or 1s, whichever is the smaller
I.R.	$R_V < 100V$ IR Voltage = R_V $R_V \geq 100V$ IR Voltage = 100V	100%	N/a	CECC 32 100 Clause 4.6.3	Min IR ($G\Omega$) = 100 or (1000/Cap in nF) (whichever is less)
D.P.A.	-	29	0/1	EIA-469	Cut in both directions. Inspect and measure as applicable. Free from internal defects
Solderability	-	10	0/1	IEC 60068-2-58 Test Td	Dip and look method. >95% coverage
Temperature Characteristic of Capacitance	Carried out for each manufacturing batch of dielectric material	-	-	CECC 32 100 Clause 4.7.2	C0G TC $0 \pm 30ppm/^{\circ}C$ over $-55^{\circ}C / +125^{\circ}C$ ($+175^{\circ}C$ for H17), no volts applied

Performance

Periodic Tests conducted on randomly selected batches

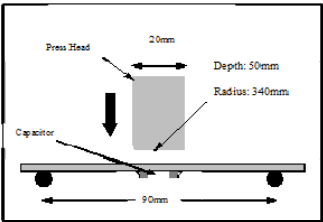
Test	Additional Requirements	Test Method	
High Temperature Exposure (Storage)	Un-powered. 1000 hours @ T=150°C. Measurement at 24 ± 2 hours after test conclusion	MIL-STD-202 Method 108	Un-mounted. Post test measure at room temperature within 24 ± 2 hours
Temperature Cycling	1000 cycles -55°C to +125°C (+175°C for H17). Measurement at 24 ± 2 hours after test conclusion	JESD22 Method JA-104	Mounted on standard test boards. 5mins soak at extremes Post test measure at room temperature within 24 ± 2 hours
Moisture Resistance	T = 24 hours/cycle. Note: Steps 7a & 7b not required. Un-powered. Measurement at 24 ± 2 hours after test conclusion	MIL-STD-202 Method 106	Preconditioning at 50°C for 24 hrs followed by 10 cycles of 25°C to 65°C at 95%RH. Post test measure at room temperature within 24 ± 2 hours
Biased Humidity	1000 hours 85°C/85%RH. Applied voltage 50V and 1.5V Measurement at 24 ± 2 hours after test conclusion	MIL-STD-202 Method 103	Mounted on test boards. Post test measure at room temperature within 24 ± 2 hours
Operational Life	Condition D Steady State T _A =125°C at 1.5 x R _v . Measurement at 24 ± 2 hours after test conclusion	MIL-STD-202 Method 108	Mounted on test leads Post test measure at room temperature within 24 ± 2 hours
Mechanical Shock	Figure 1 of Method 213. Condition F	MIL-STD-202 Method 213	3x half sine shock pulses of 1.5kg peak.
Vibration	5g's for 20 minutes, 12 cycles each of 3 orientations. Note: Use 8"X5" PCB .031" thick 7 secure points on one long side and 2 secure points at corners of opposite sides. Parts mounted within 2" from any secure point. Test from 10-2000Hz	MIL-STD-202 Method 204	Post test measure at room temperature within 24 ± 2 hours
Resistance to Soldering Heat	Condition B, no pre-heat of samples: Single Wave Solder – Procedure 2	MIL-STD-202 Method 210	Samples subjected to solder dip at 260°C for 10±1s. Immersion and emersion rates = 25±6mm/s.
Thermal Shock	-55°C/+125°C. Number of cycles 300. Maximum transfer time – 20 seconds, Dwell time – 15 minutes. Air-Air	MIL-STD-202 Method 107	Mounted on test boards. Post test measure at room temperature within 24 ± 2 hours
Board Flex	 <p>3mm deflection Class I</p>	AEC-Q200-005	Bend test substrate with the capacitor for 60s+5s.
Terminal Strength	Force of 1.0kg (0603) or 1.8kg (0805) for 60 seconds	AEC-Q200-006	Mounted on test substrate. Force applied to side of component by calibrated load cell. Post test measure at room temperature within 24 ± 2 hours and visual
Damp Heat Steady State	56 days, 40°C/ 93%RH. 15 x no volts, 15 x 5Vdc, 15 x 50V	BS EN132100 Clause 4.14	Mounted on test boards. Tested within 15mins of removal from chamber. Final measurements after 1 to 2hrs recovery time

Soldering Information

Knowles (Syfer) MLCCs are compatible with all recognised soldering/mounting methods for chip capacitors. A detailed application note is available at www.knowlesc capacitors.com

Reflow Soldering

Knowles recommend reflow soldering as the preferred method for mounting MLCCs. Knowles (Syfer) MLCCs can be reflow soldered using the internationally recognised reflow profile defined in IPC/FEDEC J-STD-020. Sn plated termination chip capacitors are compatible with both conventional and lead free soldering with peak temperatures of 260°C to 270°C acceptable.

The heating ramp rate should be such that components see a temperature rise of 1.5°C to 4°C per second to maintain temperature uniformity through the MLCC.

The time for which the solder is molten should be maintained at a minimum, so as to prevent solder leaching. Extended times above 230°C can cause problems with oxidation of Sn plating. Use of an inert atmosphere can help if this problem is encountered. Palladium/Silver (Pd/Ag) terminations can be particularly susceptible to leaching with free lead, tin rich solders and trials are recommended for this combination.

Cooling to ambient temperature should be allowed to occur naturally, particularly if larger chip sizes are being soldered. Natural cooling allows a gradual relaxation of thermal mismatch stresses in the solder joints. Forced cooling should be avoided as this can induce thermal breakage.

IPC / J-STD-020D Reflow Specification

SnPb Classification Temperature		
Package Thickness	Volume mm ³ <350	Volume mm ³ ≥350
<2.5mm	235°C	220°C
≥2.5mm	220°C	220°C

Pb Free Classification Temperature			
Package Thickness	Volume mm ³ <350	Volume mm ³ 350 - 2000	Volume mm ³ >2000
<1.6mm	260°C	260°C	260°C
1.6mm - 2.5mm	260°C	250°C	245°C
>2.5mm	250°C	245°C	245°C

Profile Feature	Sn-Pb Eutectic Assembly	Pb-Free Assembly
Preheat & Soak Temperature min (T _{smin}) Temperature max (T _{smax}) Time (T _{smin} to T _{smax}) (t _s)	100°C 150°C 60 - 120 seconds	150°C 200°C 60 - 120 seconds
Average ramp-up rate (T _{smax} to T _p)	3°C/second max	3°C/second max
Liquidous temperature (T _L) Time at liquidous (t _L)	183°C 60 - 150 seconds	217°C 60 - 150 seconds
Peak package body temperature (T _p)	See classification in temp Table above	See classification in temp Table above
Time (t _p) within 5°C of the specified classification temperature (T _c)	20 seconds	30 seconds
Average ramp-down rate (T _p to T _{smax})	6°C/second max.	6°C/second max.
Time 25°C to peak temperature	6 minutes max.	8 minutes max.

Reflow profiles in this document are for recommended limits. Actual board assembly profiles should be developed based on specific process needs and board designs and should not exceed the parameters in the Table above

We cannot give a definitive profile of the actual peak temperatures, as this is dependent on a number of factors which can only be decided by the assembler – the type of solder used, the size, specification and arrangement of other components on the board and the overall thermal mass of the board.

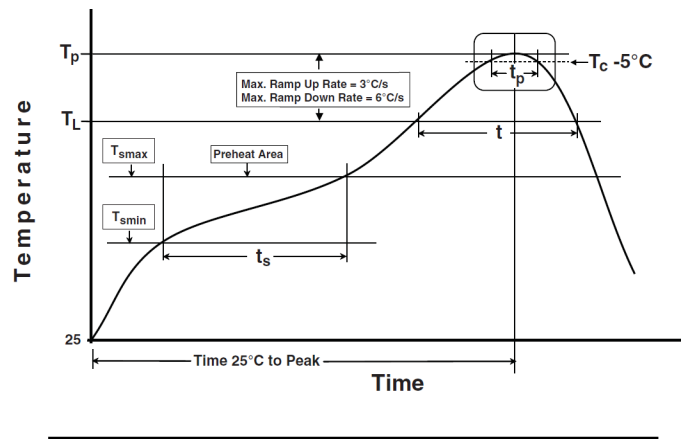

Wave Soldering

Wave soldering is generally acceptable, but the thermal stresses caused by the wave have been shown to lead to potential problems with larger or thicker chips. Particular care should be taken when soldering SM chips larger than size 1210 and with a thickness greater than 1.0mm for this reason.

Maximum permissible wave temperature is 270°C for SM chips.

The total immersion time in solder should be kept to a minimum. It is strongly recommended that Sn/Ni plated terminations are specified for wave soldering applications

If wave soldering is to be carried out, we recommend a profile of the general shape as below (single wave of the same general shape is also acceptable).

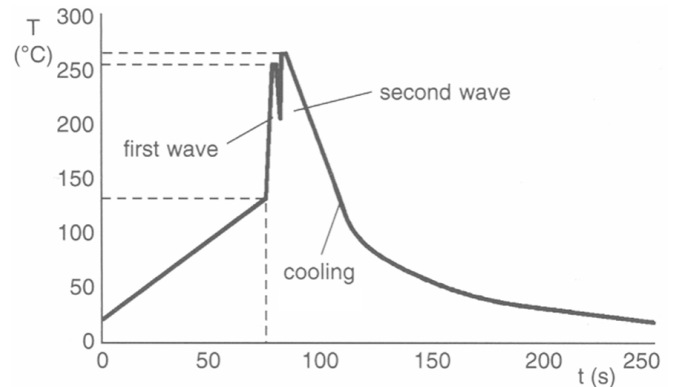

Total immersion exposure time for Sn/Ni terminations is 30s at a wave temperature of 260°C. Note that for multiple soldering operations, including the rework, the soldering time is cumulative.

Rework of Chip Capacitors

Knowles recommend hot air/gas as the preferred method of applying heat for rework. Apply even heat surrounding the component to minimise internal thermal gradients. Soldering irons or other techniques that apply direct heat to the chip or surrounding area, should not be used as these can result in micro cracks being generated.

Minimise the rework heat duration and allow components to cool naturally after soldering.

If soldering irons must be used, then place the tip on the board close to the component and allow the heat to be transferred to the component. Do not allow the tip of the iron to come into contact with the chip body directly.

Use of Silver Loaded Epoxy Adhesives

Chip capacitors can be mounted to circuit boards using silver loaded adhesive provided the termination material of the capacitor is selected to be compatible with the adhesive. This is normally PdAg. Standard tin finishes are often not recommended for use with silver loaded epoxies as there can be electrical and mechanical issues with the joint integrity due to material mismatch.

Handling & Storage

Components should never be handled with fingers; perspiration and skin oils can inhibit solderability and will aggravate cleaning.

Chip capacitors should never be handled with metallic instruments. Metal tweezers should never be used as these can chip the product and leave abraded metal tracks on the product surface. Plastic or plastic coated metal types are readily available and recommended – these should be used with an absolute minimum of applied pressure.

Incorrect storage can lead to problems for the user. Rapid tarnishing of the terminations, with an associated degradation of solderability, will occur if the product comes into contact with industrial gases such as sulphur dioxide and chlorine. Storage in free air, particularly moist or polluted air, can result in termination oxidation.

Packaging should not be opened until the MLCs are required for use. If opened, the pack should be re-sealed as soon as practicable. Alternatively, the contents could be kept in a sealed container with an environmental control agent.

Long term storage conditions, ideally, should be temperature controlled between -5 and +40°C and humidity controlled between 40% and 60% R.H.

Taped product should be stored out of direct sunlight, which might promote deterioration in tape or adhesive performance.

Product, stored under the conditions recommended above, in its "as received" packaging, has a minimum shelf life of 2 years.

SM Pad Design

Knowles (Syfer) conventional 2-terminal chip capacitors can generally be mounted using pad designs in accordance with international specification IPC-7351, Generic Requirements for Surface Mount Design and Land Pattern Standards, but there are some other factors that have been shown to reduce mechanical stress, such as reducing the pad width to less than the chip width. In addition, the position of the chip on the board should also be considered.

IPC-7351 pad design for 0603, 0805 & 1111 MLCC

	0603	0805	1111
C	1.60	1.80	2.80
Y	0.85	1.15	1.20
X	1.00	1.45	3.20

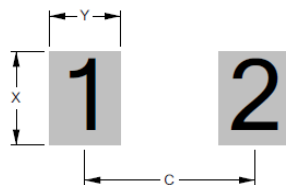

Mechanical Cracking considerations

Mechanical cracking is one of the main causes of failure in MLCC's. Some design considerations can reduce the instances of mechanical cracking.

Assembly Design/ Manufacture Considerations

Mechanical stress can be influenced by a number of different factors associated with the design of the assembly and assembly manufacture. These factors include:

- PCB design – copper power and ground planes.
- A PCB design resulting in an uneven metal distribution (usually caused by large power or ground planes) can result in PCB warpage during the soldering process caused by the different Thermal Coefficient of Expansion rates between the copper and the epoxy fibre glass. If large power/ ground planes are required then cross hatching the copper area may prove to be useful.
- Position/ orientation of the capacitor on the PCB in relation to the edge of the PCB and other components/ attachments.

PCB Corner

PCB Edge

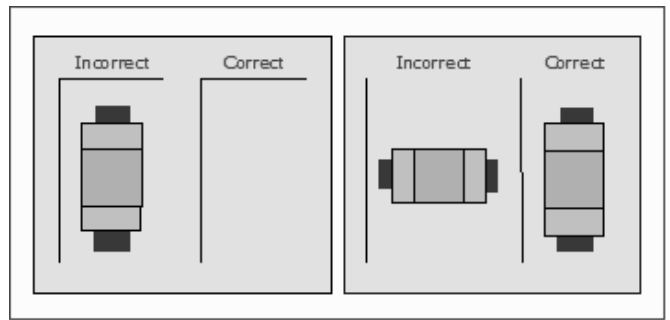

Capacitor placement not recommended in the corner of the PCB.

Recommended capacitor orientation with respect to PCB edge (denoted by black lines).

Note: Stress zone is typically within 5mm of PCB edge or fixing point.

Use of PCB Slots

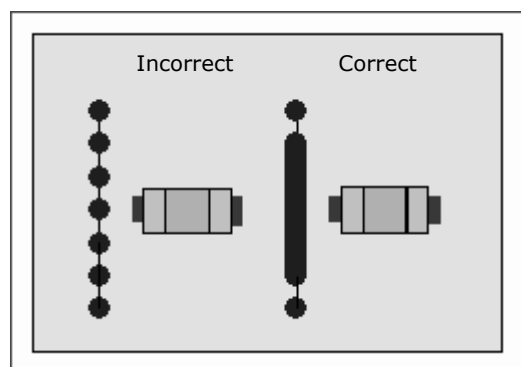

Using a slot along the depanelisation edge reduces the level of stress exerted onto the capacitor by approximately 50%.

Solder pad/ land sizes

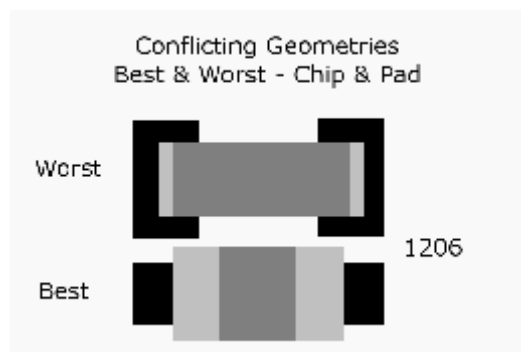

Reducing the pad/ land size can reduce the level of stress exerted onto the capacitor by approximately 50%.

Use of adhesives

Depending upon the type of adhesive used, the effect can be a significant reduction in the bend strength of a capacitor. For example, during experiments approximately 50% of the PCB bend was required to crack a capacitor fixed with adhesive when compared to a capacitor not fixed with adhesive.

FlexiCap™ Termination

FlexiCap™ has been developed as a result of listening to customer's experiences of stress damage to MLCCs from many manufacturers, often caused by variations in production processes.

Our answer is a proprietary flexible epoxy polymer termination material that is applied to the device under the usual nickel barrier finish. FlexiCap™ will accommodate a greater degree of board bending than conventional capacitors.

Note : FlexiCap™ is not available on all ranges. See individual range ordering information for details

Ranges are available with FlexiCap™ termination material offering increased reliability and superior mechanical performance (board flex and temperature cycling) when compared with standard termination materials. Refer to Knowles application note reference AN0001. FlexiCap™ capacitors enable the board to be bent almost twice as much as before mechanical cracking occurs. Refer to application note AN0002.

FlexiCap™ is also suitable for space applications having passed thermal vacuum outgassing tests. Refer to Knowles application note reference AN0026.

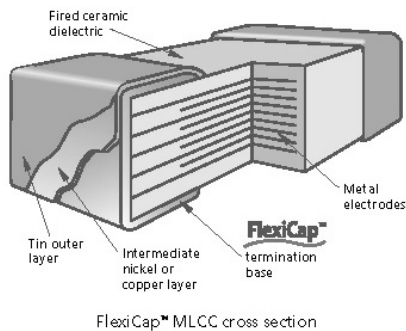

FlexiCap™ MLCC cross section

Knowles has delivered millions of FlexiCap™ components and during that time has collected substantial test and reliability data, working in partnership with customers world wide, to eliminate mechanical cracking.

An additional benefit of FlexiCap™ is that MLCCs can withstand temperature cycling from -55 to 125°C in excess of 1,000 times without cracking.

FlexiCap™ termination has no adverse effect on any electrical parameters, nor affects the operation of the MLCC in any way.

Application Notes

FlexiCap™ may be handled, stored and transported in the same manner as standard terminated capacitors. The requirements for mounting and soldering FlexiCap™ are the same as for standard SMD capacitors.

For customers currently using standard terminated capacitors there should be requirement to change the assembly process when converting to FlexiCap™.

Based upon the board bend tests in accordance with IEC 60384-1 the amount of board bending required to mechanically crack a FlexiCap™ terminated capacitor is significantly increased compared with standard terminated capacitors.

Product: X7R	Typical bend performance under AEC-Q200 test conditions
Standard Termination	2mm to 3mm
FlexiCap™	Typically 8mm to 10mm

REACH (Registration, Evaluation, Authorisation and restriction of Chemicals) Statement

The main purpose of REACH is to improve the protection of human health and the environment from the risks arising from the use of chemicals.

Knowles maintain both ISO 14001, Environmental Management System and OHSAS 18001 Health & Safety Management System approvals that require and ensure compliance with corresponding legislation such as REACH.

For further information, please contact your local sales office using the e-mail addresses at the front of this datasheet

RoHS Compliance

Knowles routinely monitor world wide material restrictions (e.g., EU/China and Korea RoHS mandates) and is actively involved in shaping future legislation.

All standard COG/NPO, X7R, X5R and High Q Knowles MLCC products are compliant with the EU RoHS directive (see below for special exemptions) and those with plated terminations are suitable for soldering common lead free solder alloys (refer to 'Soldering Information' for more details on soldering limitations). Compliance with EU RoHS directive automatically signifies compliance with some other legislation (e.g., Korea RoHS). Please refer to the Sales Office for details of compliance with other materials legislation.

Breakdown of material content, SGS analysis reports and tin whisker test results are available on request.

Most Knowles (Syfer) MLCC components are available with non-RoHS compliant tin/lead (SnPb) Solderable termination finish for exempt applications and where pure tin is not acceptable. Other tin free termination finishes may also be available – please refer to the Sales Office for further details.

For the latest data, environmental certificates can be downloaded from www.knowlesc capacitors.com

Export Controls and Dual-use Regulations

Certain Knowles catalogue components are defined as 'dual-use' items under international export controls – those that can be used for civil and military purposes which meet certain specified technical standards.

The defining criteria for a dual-use component with respect to Knowles products is one with a voltage rating of >750V and a capacitance value >250nF and a series inductance <10nH.

Components defined as 'dual-use' under the above criteria automatically require a licence for export outside the EU, and may require a licence for export with the EU.

The application for a licence is routine, but customers for these products will be asked to supply further information.

Please refer to the sales office if you require any further information on export restrictions.

Other special components may additionally need to comply with export regulations.

Ageing of Ceramic Capacitors

Capacitor ageing is a term used to describe the negative, logarithmic capacitance change which takes place in ceramic capacitors with time. The crystalline structure for barium titanate based ceramics changes on passing through its Curie temperature (known as the Curie Point) at about 125°C. The domain structure relaxes with time and in doing so, the dielectric constant reduces logarithmically; this is known as the ageing mechanism of the dielectric constant. The more stable dielectrics have the lowest ageing rates.

The ageing process is reversible and repeatable. Whenever the capacitor is heated to a temperature above the Curie Point the ageing process starts again from zero.

The ageing constant, or ageing rate, is defined as the percentage loss of capacitance due to the ageing process of the dielectric which occurs during a decade of time (a tenfold increase in age) and is expressed as percent per logarithmic decade of hours. As the law of decrease of capacitance is logarithmic, this means that for a capacitor with an ageing rate of 1% per decade of time, the capacitance will decrease at a rate of:

- a) 1% between 1 and 10 hours
- b) An additional 1% between the following 10 and 100 hours
- c) An additional 1% between the following 100 and 1000 hours
- d) An additional 1% between the following 1000 and 10000 hours
- e) The ageing rate continues in this manner throughout the capacitor's life.

Typical values of the ageing constant for our MLCCs are

Dielectric Class	Typical Values
Ultra Stable COG/NP0	Negligible capacitance loss through ageing
Stable X7R	<2% per decade of time

Capacitance Measurements

Because of ageing it is necessary to specify an age for reference measurements at which the capacitance shall be within the prescribed tolerance. This is fixed at 1000 hours, since for all practical purposes there is not much further loss of capacitance after this time.

All capacitors shipped are within their specified tolerance at the standard reference age of 1000 hours after having cooled through their Curie temperature.

The ageing curve for any ceramic dielectric is a straight line when plotted on semi-log paper.

Capacitance vs. Time

(Ageing X7R @ 1% per decade)

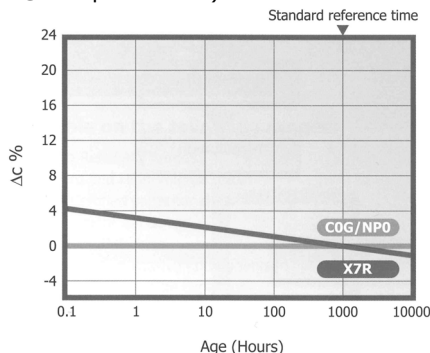

Tight Tolerance

One of the advantages of Knowles's unique 'wet process' of manufacture is the ability to offer capacitors with exceptionally tight capacitance tolerances.

The accuracy of the printing screens used in the fully automated, computer controlled manufacturing process allows for tolerance as close as ± 1% on COG/NP0 parts greater than or equal to 10pF. For capacitance value less than 4.7pF tolerances can be as tight as ± 0.05pF.

Periodic Tests Conducted and Reliability Data

For standard surface mount capacitors components are randomly selected on a sample basis and the following routine tests conducted:

- Load Test. 1,000 hours @ 125°C (150°C for X8R). Applied voltage depends on components tested
- Humidity Test. 168 hours @ 85°C/85%RH
- Board Deflection (bend test)

Test results are available on request.

Conversion Factors

From	To	Operation
FITs	MTBF (hours)	10 ⁹ ÷ FITs
FITs	MTBF (years)	10 ⁹ ÷ (FITs × 8760)

FIT = Failures In Time. 1 FIT = 1 failure in 10⁹ hours

MTBF = Mean Time Between Failure

Example of FIT Data Available

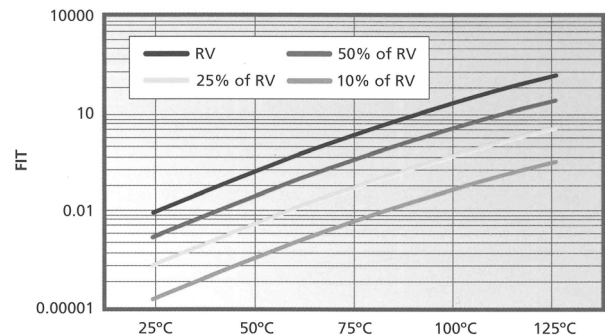

Component type: 0805 (COG/NP0 and X7R)
 Testing Location: Knowles reliability test department
 Results based on: 16,622,000 component test hours

Packaging Information

Tape and reel packing of surface mounting chip capacitors for

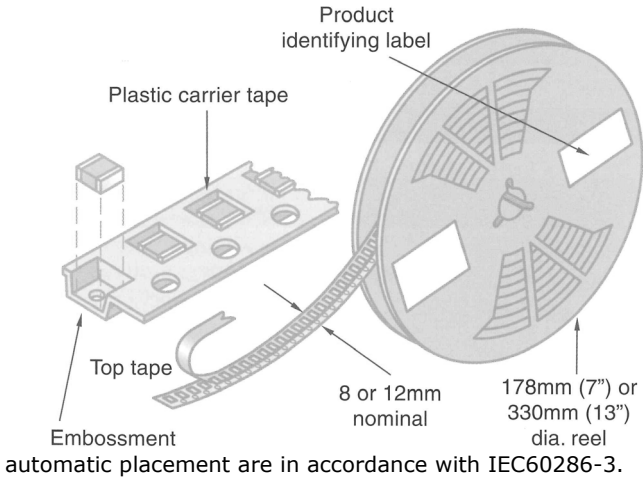

Peel Force

The peel force of the top sealing tape is between 0.2 and 1.0 Newton at 180°. The breaking force of the carrier and sealing tape in the direction of unreeling is greater than 10 Newton.

Reel Dimensions

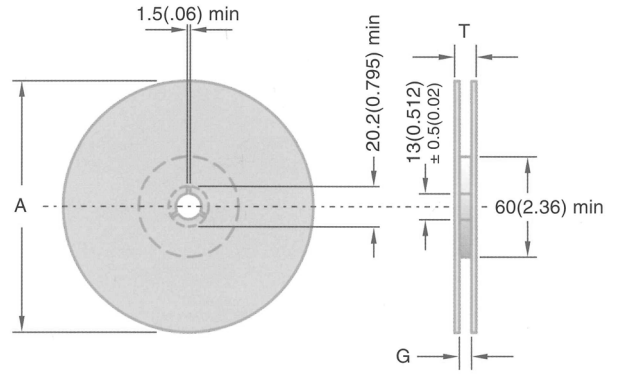

Symbol	Description	178mm Reel	330mm Reel
A	Reel diameter	178 (7)	330 (13)
G	Reel inside width	8.4 (0.33)	12.4 (0.49)
T	Reel outside width	14.4 (0.56) max	18.4 (0.72) max

Tape Dimensions

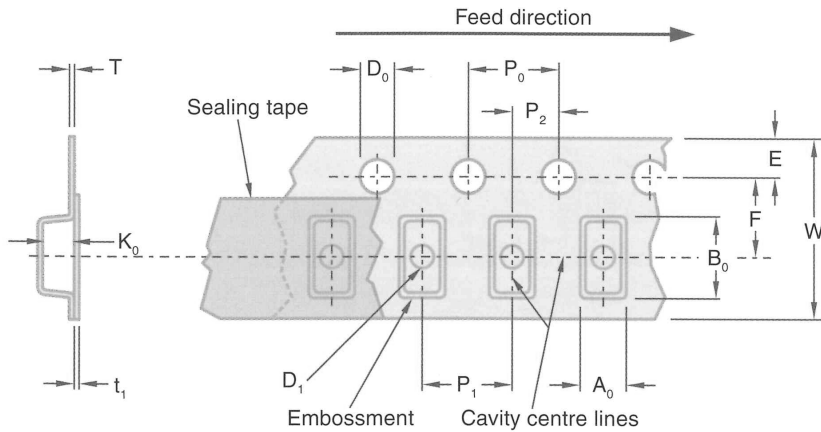

Symbol	Description	Dimensions mm (inches)	
		8mm Tape	12mm Tape
A ₀	Width of cavity	Dependent on chip size to minimize rotation	
B ₀	Length of cavity		
K ₀	Depth of cavity		
W	Width of tape	8.0 (0.315)	12.0 (0.472)
F	Distance between drive hole centres and cavity centres	3.5 (0.138)	5.5 (0.213)
E	Distance between drive hole centres and tape edge	1.75 (0.069)	
P ₁	Distance between cavity centres	4.0 (0.156)	8.0 (0.315)
P ₂	Axial distance between drive hole centres and cavity centres	2.0 (0.079)	
P ₀	Axial distance between drive hole centres	4.0 (0.156)	
D ₀	Drive hole diameter	1.5 (0.059)	
D ₁	Diameter of cavity piercing	1.0 (0.039)	1.5 (0.059)
T	Carrier tape thickness	0.3 (0.012) ± 0.1 (0.04)	0.4 (0.016) ± 0.1 (0.04)
t ₁	Top tape thickness	0.1 (0.004) max	

Packing Information

Missing Components

The number of missing components in the tape may not exceed 0.25% of the total quantity with not more than three consecutive components missing. This must be followed by at least six properly placed components

Identification

Each reel is labelled with the following information: manufacturer, chip size, capacitance, tolerance, rated voltage, dielectric type, batch number, date code and quantity of components.

Component Orientation

Tape and reeling is in accordance with IEC 60286 part 3, which defines the packaging specifications for leadless components on continuous tapes.

- Notes: 1) IEC60286-3 states A0 <B0
 2) Regarding the orientation of 1825 and 2225 components, the termination bands are right to left, NOT front to back. Please see diagram.

Leader Trailer

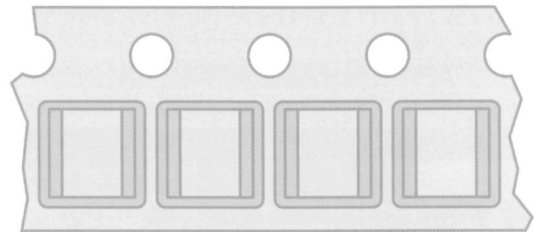
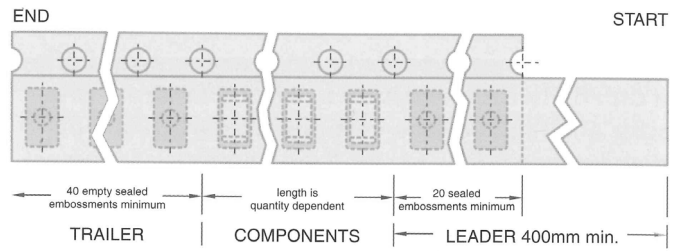

Orientation of 1825 & 2225 components

Outer Packaging

Outer carton dimensions mm (inches) max

Reel Size	No. of Reels	L	W	T
178 (7)	1	185 (7.28)	185 (7.28)	25 (0.98)
178 (7)	4	190 (7.48)	195 (7.76)	75 (2.95)
330 (13)	1	335 (13.19)	335 (13.19)	25 (0.98)

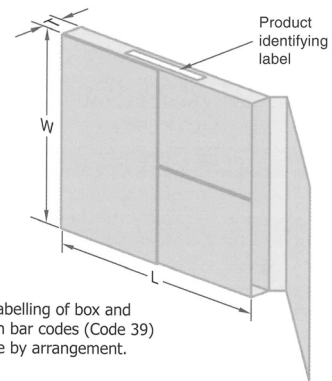

Note: Labelling of box and reel with bar codes (Code 39) available by arrangement.

Reel Quantities

Chip Size	0402	0505	0603	0805	1111	1206	1210	1410	1808	1812	1825	2211	2215	2220	2225
Max. Chip Thickness	0.5mm	1.3mm	0.8mm	1.3mm	2.0mm	1.6mm	2.0mm	2.0mm	2.0mm	2.5mm	2.5mm	2.5mm	2.5mm	2.5mm	2.5mm
	0.02"	0.05"	0.03"	0.05"	0.08"	0.06"	0.08"	0.08"	0.08"	0.1"	0.1"	0.1"	0.1"	0.1"	0.1"
Reel Quantities	178mm (7")	10000	2500	4000	3000	1000	2500	2000	2000	1500	500	500	750	500	500
	330mm (13")	15000	10000	16000	12000	5000	10000	8000	8000	6000	2000	2000	4000	4000	2000

Notes:

- The above quantities per reel are for the maximum manufactured chip thickness. Thinner chips can be taped in larger quantities per reel.
- Where two different quantities are shown for the same case size, please contact the sales office to determine the exact quantity for any specific part number.

Bulk Packing – Tubs

Chips are supplied in rigid re-sealable plastic tubs together with impact cushioning wadding. Tubs are labelled with the details: chip size, capacitance, tolerance, rated voltage, dielectric type, batch number, date code and quantity of components.

Dimensions mm (inches)

H	60mm (2.36")
D	50mm (1.97")

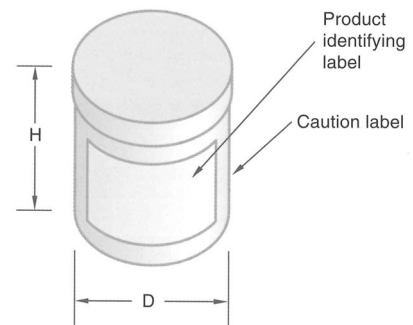

OUR CERTIFICATE

DiGi provide top-quality products and perfect service for customer worldwide through standardization, technological innovation and continuous improvement. DiGi through third-party certification, we stricly control the quality of products and services. Welcome your RFQ to

Email: Info@DiGi-Electronics.com



Tel: +00 852-30501935

RFQ Email: Info@DiGi-Electronics.com

DiGi is a global authorized distributor of electronic components.