

TRJC336M010RRJ Datasheet

www.digi-electronics.com

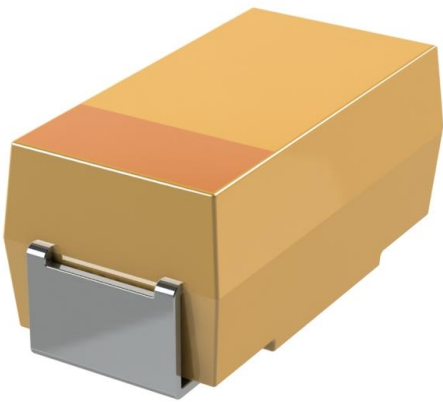

<https://www.DiGi-Electronics.com>

DiGi Electronics Part Number	TRJC336M010RRJ-DG
Manufacturer	KYOCERA AVX
Manufacturer Product Number	TRJC336M010RRJ
Description	CAP TANT 33UF 20% 10V 2312
Detailed Description	33 μ F Molded Tantalum Capacitors 10 V 2312 (6032 Metric) 590mOhm

This model TRJC336M010RRJ is available at DiGi Electronics.

DiGi Electronics offers a global database of semiconductor and electronic component datasheets.

We welcome your inquiries regarding pricing, lead time, or other product-related questions.

 [Request a Quote](#)

 [Datasheet Search](#)



Tel: +00 852-30501935

RFQ Email: Info@DiGi-Electronics.com

DiGi is a global authorized distributor of electronic components.

Purchase and inquiry

Manufacturer Product Number:

TRJC336M010RRJ

Series:

TRJ

Capacitance:

33 μ F

Voltage - Rated:

10 V

ESR (Equivalent Series Resistance):

590mOhm

Lifetime @ Temp.:

-

Package / Case:

2312 (6032 Metric)

Height - Seated (Max):

0.110" (2.80mm)

Manufacturer Size Code:

C

Failure Rate:

-

Manufacturer:

KYOCERA AVX

Product Status:

Active

Tolerance:

\pm 20%

Type:

Molded

Operating Temperature:

-55°C ~ 125°C

Mounting Type:

Surface Mount

Size / Dimension:

0.236" L x 0.126" W (6.00mm x 3.20mm)

Lead Spacing:

-

Features:

General Purpose

Environmental & Export classification

RoHS Status:

ROHS3 Compliant

REACH Status:

REACH Unaffected

HTSUS:

8532.21.0050

Moisture Sensitivity Level (MSL):

1 (Unlimited)

ECCN:

EAR99

TRJ Series

Professional Tantalum Chip Capacitor

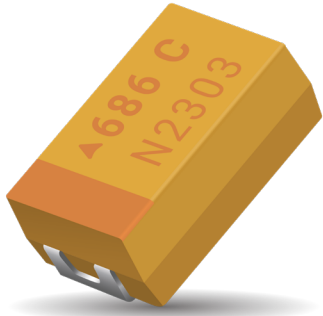

FEATURES

- Improved Reliability – 2x Standard
- DCL Reduced by 25% to 0.0075 CV
- Robust Against Higher Thermo-mechanical Stresses During Assembly Process
- 100% Surge Current Tested
- CV Range: 0.10-680µF / 4-50V
- 6 Case Sizes Available
- 131 Low ESR Parts Released
- Automotive, Industrial and Other Higher End Applications



SnPb termination option is not RoHS compliant.

APPLICATIONS

- Automotive ECU
- ABS
- Airbag Systems
- Avionics
- Industrial Control Units

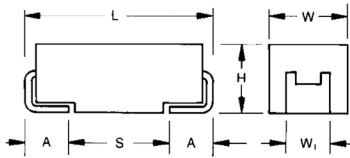

CASE DIMENSIONS:

millimeters (inches)

Code	EIA Code	EIA Metric	L±0.20 (0.008)	W+0.20 (0.008) -0.10 (0.004)	H+0.20 (0.008) -0.10 (0.004)	W ₁ ±0.20 (0.008)	A+0.30 (0.012) -0.20 (0.008)	S Min.
A	1206	3216-18	3.20 (0.126)	1.60 (0.063)	1.60 (0.063)	1.20 (0.047)	0.80 (0.031)	1.10 (0.043)
B	1210	3528-21	3.50 (0.138)	2.80 (0.110)	1.90 (0.075)	2.20 (0.087)	0.80 (0.031)	1.40 (0.055)
C	2312	6032-28	6.00 (0.236)	3.20 (0.126)	2.60 (0.102)	2.20 (0.087)	1.30 (0.051)	2.90 (0.114)
D	2917	7343-31	7.30 (0.287)	4.30 (0.169)	2.90 (0.114)	2.40 (0.094)	1.30 (0.051)	4.40 (0.173)
E	2917	7343-43	7.30 (0.287)	4.30 (0.169)	4.10 (0.162)	2.40 (0.094)	1.30 (0.051)	4.40 (0.173)
U	2924	7361-43	7.30 (0.287)	6.10 (0.240)	4.10 (0.162)	3.10 (0.122)	1.30 (0.051)	4.40 (0.173)

W₁ dimension applies to the termination width for A dimensional area only.

MARKING

A, B, C, D, E, U CASE

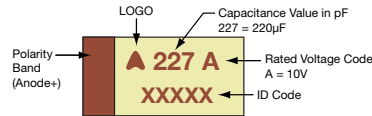

HOW TO ORDER

TRJ	B	105	*	035	R	RJ	—
Type	Case Size See table above	Capacitance Code pF code: 1st two digits represent significant figures, 3rd digit represents multiplier (number of zeros to follow)	Tolerance K = ±10% M = ±20%	Rated DC Voltage 004 = 4V 006 = 6.3V 010 = 10V 016 = 16V 020 = 20V 025 = 25V 035 = 35V 050 = 50V	Packaging R = Pure Tin 7" Reel S = Pure Tin 13" Reel A = Gold Plating 7" Reel B = Gold Plating 13" Reel H = Tin Lead 7" Reel K = Tin Lead 13" Reel H, K = Non RoHS A, B, H, K = Please Contact Manufacturer	Standard Suffix OR 0100 Low ESR in mΩ	Additional characters may be added for special requirements V = Dry pack Option (selected codes only, please contact manufacturer)

TECHNICAL SPECIFICATIONS

Technical Data:	All technical data relate to an ambient temperature of +25°C								
Capacitance Range:	0.10 µF to 680 µF								
Capacitance Tolerance:	±10%; ±20%								
Leakage Current DCL:	0.0075CV or 0.3µA whichever is the greater								
Rated Voltage (V _R)	≤ + 85°C:	4	6.3	10	16	20	25	35	50
Category Voltage (V _C)	≤ + 125°C:	2.7	4	7	10	13	17	23	33
Surge Voltage (V _S)	≤ + 85°C:	5.2	8	13	20	26	32	46	65
Surge Voltage (V _S)	≤ + 125°C:	3.4	5	8	13	16	20	28	40
Temperature Range:	-55°C to +125°C								
Reliability:	0.5% per 1000 hours at 85°C, V _R with 0.1Ω/V series impedance, 60% confidence level								
Termination Plating:	Sn Plating (standard), Gold and SnPb Plating upon request								
	Meets requirements of AEC-Q200								

TRJ Series

Professional Tantalum Chip Capacitor

CAPACITANCE AND RATED VOLTAGE RANGE (LETTER DENOTES CASE SIZE)

Capacitance		Rated Voltage DC (V_R) to 85°C							
μF	Code	4V (G)	6.3V (J)	10V (A)	16V (C)	20V (D)	25V (E)	35V (V)	50V (T)
0.10	104							A	
0.15	154							A, A(6000)	
0.22	224							A, A(6000)	A, A(7000)
0.33	334							A, A(6000)	A
0.47	474						A, A(7000)	A, A(4000)	B
0.68	684						A, A(6000)	A, A(6000)	B, B(2000)
1.0	105				A	A, A(3000)	A, A(3000)	A, B A(3000), B(2000)	C, B B(2000)
1.5	155			A		A, A(3000)	A, B, A(3000)	A, B A(2000), B(2500)	C, C(1500)
2.2	225			A	A, A(3500)	A, A(3000)	A, B A(1600), B(1200)	B, B(2000)	C, D C(1000), D(1200)
3.3	335				A, B A(3500)	A, B A(2500), B(1300)	B, B(2000)	B, C, D B(1000), C(800)	C, D C(1000), D(800)
4.7	475			A, A(2000)	A, B A(2000), B(1500)	A, B, A(1800), B(1000)	B, B(1000)	B, C, D B(1500), C(600)	D, D(600)
6.8	685			A, B, A(1800)	A, B, C A(1500), B(1200)	B, C B(1000)	B, C B(1000), C(600)	C, D C(600)	D
10	106		A, B A(1500)	A, B A(1800), B(800)	B, C B(800)	B, C B(1000), C(500)	C, D C(600)	C, D C(600), D(250,400)	E, E(300,400)
15	156		A, B A(1500), B(700)	A, B, C A(1000), B(600)	B, B(800)	B, C, D B(500), C(400)	C, D C(500), D(300)	D, D(225)	U
22	226		A, B, C A(900), B(600)	B, B(700)	B, C, D B(600), C(350)	C, D, C(400), D(150,300)	D, D(300)	D, D(200,400)	U
33	336	C	B, C B(600)	B, C, D B(650), C(300)	C, C(300)	C, D C(300), D(250)	D, D(400)	E, E(150,250)	
47	476		B, C B(500), C(250)	C, D C(300)	C, D C(350), D(200)	D, D(200)	D, E D(250), E(150)	U, U(200)	
68	686		C, C(200)	C, C(300)	C, D C(200), D(150)	D, E D(200), E(120,200)	U		
100	107		C, C(300)	C, D, E C(200), D(100,150), E(100)	D, E D(150), E(150)	E, E(150)	U		
150	157		C, D C(300), D(150)	D, E D(150), E(150)	E, E(150)	U, U(250)			
220	227		D, D(150)	D, E, E(150)	U, U(200)				
330	337		D, E, E(150)	E, E(100)	U, U(200)				
470	477		E, E(200)	U, U(200)					
680	687		U, U(250)						

Released ratings, (ESR ratings in mOhms in parentheses)

Note: Voltage ratings are minimum values. KYOCERA AVX reserves the right to supply higher voltage ratings in the same case size, to the same reliability standards.

TRJ Series

Professional Tantalum Chip Capacitor

RATINGS & PART NUMBER REFERENCE

Part Number	Case Size	Capacitance (µF)	Rated Voltage (V)	Rated Temperature (°C)	Category Voltage (V)	Category Temperature (°C)	DCL Max. (µA)	DF Max. (%)	ESR Max. @ 100kHz (mΩ)	100kHz RMS Current (mA)			MSL
										25°C	85°C	125°C	
4 Volt @ 85°C													
TRJC336*004#RJ	C	33	4	85	2.7	125	1	6	2000	235	211	94	1
6.3 Volt @ 85°C													
TRJA106*006#RJ	A	10	6.3	85	4	125	0.45	6	2200	185	166	74	1
TRJA106*006#1500	A	10	6.3	85	4	125	0.45	6	1500	224	201	89	1
TRJB106*006#RJ	B	10	6.3	85	4	125	0.45	6	3000	168	151	67	1
TRJA156*006#RJ	A	15	6.3	85	4	125	0.68	6	2030	192	173	77	1
TRJA156*006#1500	A	15	6.3	85	4	125	0.68	6	1500	224	201	89	1
TRJB156*006#RJ	B	15	6.3	85	4	125	0.68	6	2030	205	184	82	1
TRJB156*006#0700	B	15	6.3	85	4	125	0.68	6	700	348	314	139	1
TRJA226*006#RJ	A	22	6.3	85	4	125	0.99	6	1700	210	189	84	1
TRJA226*006#0900	A	22	6.3	85	4	125	0.99	6	900	289	260	115	1
TRJB226*006#RJ	B	22	6.3	85	4	125	0.99	6	1880	213	191	85	1
TRJB226*006#0600	B	22	6.3	85	4	125	0.99	6	600	376	339	151	1
TRJC226*006#RJ	C	22	6.3	85	4	125	0.99	6	2000	235	211	94	1
TRJB336*006#RJ	B	33	6.3	85	4	125	1.5	6	1740	221	199	88	1
TRJB336*006#0600	B	33	6.3	85	4	125	1.5	6	600	376	339	151	1
TRJC336*006#RJ	C	33	6.3	85	4	125	1.5	6	1800	247	222	99	1
TRJB476*006#RJ	B	47	6.3	85	4	125	2.1	6	1620	229	206	92	1
TRJB476*006#0500	B	47	6.3	85	4	125	2.1	6	500	412	371	165	1
TRJC476*006#RJ	C	47	6.3	85	4	125	2.1	6	540	451	406	181	1
TRJC476*006#0250	C	47	6.3	85	4	125	2.1	6	250	663	597	265	1
TRJC686*006#RJ	C	68	6.3	85	4	125	3.1	6	490	474	426	190	1
TRJC686*006#0200	C	68	6.3	85	4	125	3.1	6	200	742	667	297	1
TRJC107*006#RJ	C	100	6.3	85	4	125	4.5	6	440	500	450	200	1
TRJC107*006#0300	C	100	6.3	85	4	125	4.5	6	300	606	545	242	1
TRJC157*006#RJ	C	150	6.3	85	4	125	6.8	8	500	469	422	188	1
TRJC157*006#0300	C	150	6.3	85	4	125	6.8	8	300	606	545	242	1
TRJD157*006#RJ	D	150	6.3	85	4	125	6.8	6	400	612	551	245	1 ¹⁾
TRJD157*006#0150	D	150	6.3	85	4	125	6.8	6	150	1000	900	400	1 ¹⁾
TRJD227*006#RJ	D	220	6.3	85	4	125	9.9	8	360	645	581	258	1 ¹⁾
TRJD227*006#0150	D	220	6.3	85	4	125	9.9	8	150	1000	900	400	1 ¹⁾
TRJD337*006#RJ	D	330	6.3	85	4	125	14	8	400	612	551	245	1 ¹⁾
TRJE337*006#RJ	E	330	6.3	85	4	125	14	8	330	707	636	283	1 ¹⁾
TRJE337*006#0150	E	330	6.3	85	4	125	14	8	150	1049	944	420	1 ¹⁾
TRJE477*006#RJ	E	470	6.3	85	4	125	21	8	250	812	731	325	1 ¹⁾
TRJE477*006#0200	E	470	6.3	85	4	125	21	8	200	908	817	363	1 ¹⁾
TRJU687*006RRJV	U	680	6.3	85	4	125	30	30	500	574	517	230	3
TRJU687*006R0250V	U	680	6.3	85	4	125	30	30	250	812	731	325	3
10 Volt @ 85°C													
TRJA155*010#RJ	A	1.5	10	85	7	125	0.3	6	7000	104	93	41	1
TRJA225*010#RJ	A	2.2	10	85	7	125	0.3	6	7000	104	93	41	1
TRJA475*010#RJ	A	4.7	10	85	7	125	0.35	6	2900	161	145	64	1
TRJA475*010#2000	A	4.7	10	85	7	125	0.35	6	2000	194	174	77	1
TRJA685*010#RJ	A	6.8	10	85	7	125	0.51	6	2650	168	151	67	1
TRJA685*010#1800	A	6.8	10	85	7	125	0.51	6	1800	204	184	82	1
TRJB685*010#RJ	B	6.8	10	85	7	125	0.51	6	3000	168	151	67	1
TRJA106*010#RJ	A	10	10	85	7	125	0.75	6	2200	185	166	74	1
TRJA106*010#1800	A	10	10	85	7	125	0.75	6	1800	204	184	82	1
TRJB106*010#RJ	B	10	10	85	7	125	0.75	6	2200	197	177	79	1
TRJB106*010#0800	B	10	10	85	7	125	0.75	6	800	326	293	130	1
TRJA156*010#RJ	A	15	10	85	7	125	1.1	6	1800	204	184	82	1
TRJA156*010#1000	A	15	10	85	7	125	1.1	6	1000	274	246	110	1
TRJB156*010#RJ	B	15	10	85	7	125	1.1	6	2030	205	184	82	1
TRJB156*010#0600	B	15	10	85	7	125	1.1	6	600	376	339	151	1
TRJC156*010#RJ	C	15	10	85	7	125	1.1	6	2000	235	211	94	1
TRJB226*010#RJ	B	22	10	85	7	125	1.7	6	1880	213	191	85	1
TRJB226*010#0700	B	22	10	85	7	125	1.7	6	700	348	314	139	1
TRJB336*010#RJ	B	33	10	85	7	125	2.5	6	1000	292	262	117	1
TRJB336*010#0650	B	33	10	85	7	125	2.5	6	650	362	325	145	1
TRJC336*010#RJ	C	33	10	85	7	125	2.5	6	590	432	389	173	1
TRJC336*010#0300	C	33	10	85	7	125	2.5	6	300	606	545	242	1
TRJD336*010#RJ	D	33	10	85	7	125	2.5	6	1100	369	332	148	1 ¹⁾
TRJC476*010#RJ	C	47	10	85	7	125	3.5	6	540	451	406	181	1
TRJC476*010#0300	C	47	10	85	7	125	3.5	6	300	606	545	242	1
TRJD476*010#RJ	D	47	10	85	7	125	3.5	6	400	612	551	245	1 ¹⁾
TRJC686*010#RJ	C	68	10	85	7	125	5.1	6	490	474	426	190	1
TRJC686*010#0300	C	68	10	85	7	125	5.1	6	300	606	545	242	1
TRJC107*010#RJ	C	100	10	85	7	125	7.5	8	500	469	422	188	1
TRJC107*010#0200	C	100	10	85	7	125	7.5	8	200	742	667	297	1

TRJ Series

Professional Tantalum Chip Capacitor

RATINGS & PART NUMBER REFERENCE

Part Number	Case Size	Capacitance (µF)	Rated Voltage (V)	Rated Temperature (°C)	Category Voltage (V)	Category Temperature (°C)	DCL Max. (µA)	DF Max. (%)	ESR Max. @ 100kHz (mΩ)	100kHz RMS Current (mA)			MSL
										25°C	85°C	125°C	
TRJD107*010#RJ	D	100	10	85	7	125	7.5	6	440	584	525	234	1 ¹⁾
TRJD107*010#0100	D	100	10	85	7	125	7.5	6	100	1225	1102	490	1 ¹⁾
TRJD107*010#0150	D	100	10	85	7	125	7.5	6	150	1000	900	400	1 ¹⁾
TRJE107*010#RJ	E	100	10	85	7	125	7.5	6	440	612	551	245	1 ¹⁾
TRJE107*010#0100	E	100	10	85	7	125	7.5	6	100	1285	1156	514	1 ¹⁾
TRJD157*010#RJ	D	150	10	85	7	125	11	8	400	612	551	245	1 ¹⁾
TRJD157*010#0150	D	150	10	85	7	125	11	8	150	1000	900	400	1 ¹⁾
TRJE157*010#RJ	E	150	10	85	7	125	11	8	400	642	578	257	1 ¹⁾
TRJE157*010#0150	E	150	10	85	7	125	11	8	150	1049	944	420	1 ¹⁾
TRJD227*010#RJ	D	220	10	85	7	125	17	8	500	548	493	219	1 ¹⁾
TRJE227*010#RJ	E	220	10	85	7	125	17	8	360	677	609	271	1 ¹⁾
TRJE227*010#0150	E	220	10	85	7	125	17	8	150	1049	944	420	1 ¹⁾
TRJE337*010#RJ	E	330	10	85	7	125	25	8	300	742	667	297	1 ¹⁾
TRJE337*010#0100	E	330	10	85	7	125	25	8	100	1285	1156	514	1 ¹⁾
TRJU477*010RRJV	U	470	10	85	7	125	35	30	400	642	578	257	3
TRJU477*010R0200V	U	470	10	85	7	125	35	30	200	908	817	363	3
16 Volt @ 85°C													
TRJA105*016#RJ	A	1.0	16	85	10	125	0.3	6	10000	87	78	35	1
TRJA225*016#RJ	A	2.2	16	85	10	125	0.3	6	4550	128	116	51	1
TRJA225*016#3500	A	2.2	16	85	10	125	0.3	6	3500	146	132	59	1
TRJA335*016#RJ	A	3.3	16	85	10	125	0.4	6	3740	142	127	57	1
TRJA335*016#3500	A	3.3	16	85	10	125	0.4	6	3500	146	132	59	1
TRJB335*016#RJ	B	3.3	16	85	10	125	0.4	6	4500	137	124	55	1
TRJA475*016#RJ	A	4.7	16	85	10	125	0.56	6	3160	154	139	62	1
TRJA475*016#2000	A	4.7	16	85	10	125	0.56	6	2000	194	174	77	1
TRJB475*016#RJ	B	4.7	16	85	10	125	0.56	6	3160	164	148	66	1
TRJB475*016#1500	B	4.7	16	85	10	125	0.56	6	1500	238	214	95	1
TRJA685*016#RJ	A	6.8	16	85	10	125	0.82	4	2000	194	174	77	1
TRJA685*016#1500	A	6.8	16	85	10	125	0.82	4	1500	224	201	89	1
TRJB685*016#RJ	B	6.8	16	85	10	125	0.82	6	2650	179	161	72	1
TRJB685*016#1200	B	6.8	16	85	10	125	0.82	6	1200	266	240	106	1
TRJC685*016#RJ	C	6.8	16	85	10	125	0.82	6	2500	210	189	84	1
TRJB106*016#RJ	B	10	16	85	10	125	1.2	6	2200	197	177	79	1
TRJB106*016#0800	B	10	16	85	10	125	1.2	6	800	326	293	130	1
TRJC106*016#RJ	C	10	16	85	10	125	1.2	6	2000	235	211	94	1
TRJB156*016#RJ	B	15	16	85	10	125	1.8	6	2030	205	184	82	1
TRJB156*016#0800	B	15	16	85	10	125	1.8	6	800	326	293	130	1
TRJB226*016#RJ	B	22	16	85	10	125	2.6	6	1100	278	250	111	1
TRJB226*016#0600	B	22	16	85	10	125	2.6	6	600	376	339	151	1
TRJC226*016#RJ	C	22	16	85	10	125	2.6	6	700	396	357	159	1
TRJC226*016#0350	C	22	16	85	10	125	2.6	6	350	561	505	224	1
TRJD226*016#RJ	D	22	16	85	10	125	2.6	6	1100	369	332	148	1 ¹⁾
TRJC336*016#RJ	C	33	16	85	10	125	4	6	590	432	389	173	1
TRJC336*016#0300	C	33	16	85	10	125	4	6	300	606	545	242	1
TRJC476*016#RJ	C	47	16	85	10	125	5.6	6	540	451	406	181	1
TRJC476*016#0350	C	47	16	85	10	125	5.6	6	350	561	505	224	1
TRJD476*016#RJ	D	47	16	85	10	125	5.6	6	540	527	474	211	1 ¹⁾
TRJD476*016#0200	D	47	16	85	10	125	5.6	6	200	866	779	346	1 ¹⁾
TRJC686*016#RJ	C	68	16	85	10	125	8.2	6	490	474	426	190	1
TRJC686*016#0200	C	68	16	85	10	125	8.2	6	200	742	667	297	1
TRJD686*016#RJ	D	68	16	85	10	125	8.2	6	490	553	498	221	1 ¹⁾
TRJD686*016#0150	D	68	16	85	10	125	8.2	6	150	1000	900	400	1 ¹⁾
TRJD107*016#RJ	D	100	16	85	10	125	12	6	440	584	525	234	1 ¹⁾
TRJD107*016#0150	D	100	16	85	10	125	12	6	150	1000	900	400	1 ¹⁾
TRJE107*016#RJ	E	100	16	85	10	125	12	6	440	612	551	245	1 ¹⁾
TRJE107*016#0150	E	100	16	85	10	125	12	6	150	1049	944	420	1 ¹⁾
TRJE157*016#RJ	E	150	16	85	10	125	16	6	300	742	667	297	1 ¹⁾
TRJE157*016#0150	E	150	16	85	10	125	16	6	150	1049	944	420	1 ¹⁾
TRJU227*016RRJV	U	220	16	85	10	125	26.4	12	500	574	517	230	3
TRJU227*016R0200V	U	220	16	85	10	125	26.4	12	200	908	817	363	3
TRJU337*016RRJV	U	330	16	85	10	125	39	30	400	642	578	257	3
TRJU337*016R0200V	U	330	16	85	10	125	39	30	200	908	817	363	3
20 Volt @ 85°C													
TRJA105*020#RJ	A	1	20	85	13	125	0.3	4	6630	106	96	43	1
TRJA105*020#3000	A	1	20	85	13	125	0.3	4	3000	158	142	63	1
TRJA155*020#RJ	A	1.5	20	85	13	125	0.3	6	5460	117	105	47	1
TRJA155*020#3000	A	1.5	20	85	13	125	0.3	6	3000	158	142	63	1
TRJA225*020#RJ	A	2.2	20	85	13	125	0.33	6	4550	128	116	51	1
TRJA225*020#3000	A	2.2	20	85	13	125	0.33	6	3000	158	142	63	1
TRJA335*020#RJ	A	3.3	20	85	13	125	0.5	6	3740	142	127	57	1
TRJA335*020#2500	A	3.3	20	85	13	125	0.5	6	2500	173	156	69	1

TRJ Series

Professional Tantalum Chip Capacitor

RATINGS & PART NUMBER REFERENCE

Part Number	Case Size	Capacitance (µF)	Rated Voltage (V)	Rated Temperature (°C)	Category Voltage (V)	Category Temperature (°C)	DCL Max. (µA)	DF Max. (%)	ESR Max. @ 100kHz (mΩ)	100kHz RMS Current (mA)			MSL
										25°C	85°C	125°C	
TRJB335*020#RJ	B	3.3	20	85	13	125	0.5	6	3740	151	136	60	1
TRJB335*020#1300	B	3.3	20	85	13	125	0.5	6	1300	256	230	102	1
TRJA475*020#RJ	A	4.7	20	85	13	125	0.71	5	2500	184	166	74	1
TRJA475*020#1800	A	4.7	20	85	13	125	0.71	5	1800	217	196	87	1
TRJB475*020#RJ	B	4.7	20	85	13	125	0.71	6	3160	164	148	66	1
TRJB475*020#1000	B	4.7	20	85	13	125	0.71	6	1000	292	262	117	1
TRJB685*020#RJ	B	6.8	20	85	13	125	1	6	2650	179	161	72	1
TRJB685*020#1000	B	6.8	20	85	13	125	1	6	1000	292	262	117	1
TRJC685*020#RJ	C	6.8	20	85	13	125	1	6	2000	235	211	94	1
TRJB106*020#RJ	B	10	20	85	13	125	1.5	6	2200	197	177	79	1
TRJB106*020#1000	B	10	20	85	13	125	1.5	6	1000	292	262	117	1
TRJC106*020#RJ	C	10	20	85	13	125	1.5	6	800	371	334	148	1
TRJC106*020#0500	C	10	20	85	13	125	1.5	6	500	469	422	188	1
TRJB156*020#RJ	B	15	20	85	13	125	2.3	6	1400	280	252	112	1
TRJB156*020#0500	B	15	20	85	13	125	2.3	6	500	469	422	188	1
TRJC156*020#RJ	C	15	20	85	13	125	2.3	6	720	391	352	156	1
TRJC156*020#0400	C	15	20	85	13	125	2.3	6	400	524	472	210	1
TRJD156*020#RJ	D	15	20	85	13	125	2.3	6	1100	369	332	148	1 ¹⁾
TRJC226*020#RJ	C	22	20	85	13	125	3.3	6	650	411	370	165	1
TRJC226*020#0400	C	22	20	85	13	125	3.3	6	400	524	472	210	1
TRJD226*020#RJ	D	22	20	85	13	125	3.3	6	650	480	432	192	1 ¹⁾
TRJD226*020#0150	D	22	20	85	13	125	3.3	6	150	1000	900	400	1 ¹⁾
TRJD226*020#0300	D	22	20	85	13	125	3.3	6	300	707	636	283	1 ¹⁾
TRJC336*020#RJ	C	33	20	85	13	125	5	6	590	432	389	173	1
TRJC336*020#0300	C	33	20	85	13	125	5	6	300	606	545	242	1
TRJD336*020#RJ	D	33	20	85	13	125	5	6	590	504	454	202	1 ¹⁾
TRJD336*020#0250	D	33	20	85	13	125	5	6	250	775	697	310	1 ¹⁾
TRJD476*020#RJ	D	47	20	85	13	125	7.1	6	540	527	474	211	1 ¹⁾
TRJD476*020#0200	D	47	20	85	13	125	7.1	6	200	866	779	346	1 ¹⁾
TRJD686*020#RJ	D	68	20	85	13	125	10	6	490	553	498	221	1 ¹⁾
TRJD686*020#0200	D	68	20	85	13	125	10	6	200	866	779	346	1 ¹⁾
TRJE686*020#RJ	E	68	20	85	13	125	10	6	490	580	522	232	1 ¹⁾
TRJE686*020#0120	E	68	20	85	13	125	10	6	120	1173	1055	469	1 ¹⁾
TRJE686*020#0200	E	68	20	85	13	125	10	6	200	908	817	363	1 ¹⁾
TRJE107*020#RJ	E	100	20	85	13	125	15	6	300	742	667	297	1 ¹⁾
TRJE107*020#0150	E	100	20	85	13	125	15	6	150	1049	944	420	1 ¹⁾
TRJU157*020RRJV	U	150	20	85	13	125	22	30	500	574	517	230	3
TRJU157*020R0250V	U	150	20	85	13	125	22	30	250	812	731	325	3
25 Volt @ 85°C													
TRJA474*025#RJ	A	0.47	25	85	17	125	0.3	4	9530	89	80	35	1
TRJA474*025#7000	A	0.47	25	85	17	125	0.3	4	7000	104	93	41	1
TRJA684*025#RJ	A	0.68	25	85	17	125	0.3	4	7980	97	87	39	1
TRJA684*025#6000	A	0.68	25	85	17	125	0.3	4	6000	112	101	45	1
TRJA105*025#RJ	A	1	25	85	17	125	0.3	4	6630	106	96	43	1
TRJA105*025#3000	A	1	25	85	17	125	0.3	4	3000	158	142	63	1
TRJA155*025#RJ	A	1.5	25	85	17	125	0.3	6	5460	117	105	47	1
TRJA155*025#3000	A	1.5	25	85	17	125	0.3	6	3000	158	142	63	1
TRJB155*025#RJ	B	1.5	25	85	17	125	0.3	6	5000	130	117	52	1
TRJA225*025#RJ	A	2.2	25	85	17	125	0.41	6	2900	161	145	64	1
TRJA225*025#1600	A	2.2	25	85	17	125	0.41	6	1600	217	195	87	1
TRJB225*025#RJ	B	2.2	25	85	17	125	0.41	6	4550	137	123	55	1
TRJB225*025#1200	B	2.2	25	85	17	125	0.41	6	1200	266	240	106	1
TRJB335*025#RJ	B	3.3	25	85	17	125	0.62	6	3740	151	136	60	1
TRJB335*025#2000	B	3.3	25	85	17	125	0.62	6	2000	206	186	82	1
TRJB475*025#RJ	B	4.7	25	85	17	125	0.88	6	3160	164	148	66	1
TRJB475*025#1000	B	4.7	25	85	17	125	0.88	6	1000	292	262	117	1
TRJB685*025#RJ	B	6.8	25	85	17	125	1.3	6	1500	238	214	95	1
TRJB685*025#1000	B	6.8	25	85	17	125	1.3	6	1000	292	262	117	1
TRJC685*025#RJ	C	6.8	25	85	17	125	1.3	6	1070	321	289	128	1
TRJC685*025#0600	C	6.8	25	85	17	125	1.3	6	600	428	385	171	1
TRJC106*025#RJ	C	10	25	85	17	125	1.9	6	800	371	334	148	1
TRJC106*025#0600	C	10	25	85	17	125	1.9	6	600	428	385	171	1
TRJD106*025#RJ	D	10	25	85	17	125	1.9	6	1200	354	318	141	1 ¹⁾
TRJC156*025#RJ	C	15	25	85	17	125	2.8	6	720	391	352	156	1
TRJC156*025#0500	C	15	25	85	17	125	2.8	6	500	469	422	188	1
TRJD156*025#RJ	D	15	25	85	17	125	2.8	6	720	456	411	183	1 ¹⁾
TRJD156*025#0300	D	15	25	85	17	125	2.8	6	300	707	636	283	1 ¹⁾
TRJD226*025#RJ	D	22	25	85	17	125	4.1	6	650	480	432	192	1 ¹⁾
TRJD226*025#0300	D	22	25	85	17	125	4.1	6	300	707	636	283	1 ¹⁾
TRJD336*025#RJ	D	33	25	85	17	125	6.2	6	590	504	454	202	1 ¹⁾
TRJD336*025#0400	D	33	25	85	17	125	6.2	6	400	612	551	245	1 ¹⁾

TRJ Series

Professional Tantalum Chip Capacitor

RATINGS & PART NUMBER REFERENCE

Part Number	Case Size	Capacitance (µF)	Rated Voltage (V)	Rated Temperature (°C)	Category Voltage (V)	Category Temperature (°C)	DCL Max. (µA)	DF Max. (%)	ESR Max. @ 100kHz (mΩ)	100kHz RMS Current (mA)			MSL
										25°C	85°C	125°C	
TRJD476*025#RJ	D	47	25	85	17	125	8.8	6	540	527	474	211	1 ¹⁾
TRJD476*025#0250	D	47	25	85	17	125	8.8	6	250	775	697	310	1 ¹⁾
TRJE476*025#RJ	E	47	25	85	17	125	8.8	6	540	553	497	221	1 ¹⁾
TRJE476*025#0150	E	47	25	85	17	125	8.8	6	150	1049	944	420	1 ¹⁾
TRJU686*025RRJV	U	68	25	85	17	125	12	30	500	574	517	230	3
TRJU107*025RRJV	U	100	25	85	17	125	18	30	500	574	517	230	3
35 Volt @ 85°C													
TRJA104*035#RJ	A	0.1	35	85	23	125	0.3	4	20000	61	55	24	1
TRJA154*035#RJ	A	0.15	35	85	23	125	0.3	4	16470	67	61	27	1
TRJA154*035#6000	A	0.15	35	85	23	125	0.3	4	6000	112	101	45	1
TRJA224*035#RJ	A	0.22	35	85	23	125	0.3	4	13710	74	67	30	1
TRJA224*035#6000	A	0.22	35	85	23	125	0.3	4	6000	112	101	45	1
TRJA334*035#RJ	A	0.33	35	85	23	125	0.3	4	11280	82	73	33	1
TRJA334*035#6000	A	0.33	35	85	23	125	0.3	4	6000	112	101	45	1
TRJA474*035#RJ	A	0.47	35	85	23	125	0.3	4	9530	89	80	35	1
TRJA474*035#4000	A	0.47	35	85	23	125	0.3	4	4000	137	123	55	1
TRJA684*035#RJ	A	0.68	35	85	23	125	0.3	4	7980	97	87	39	1
TRJA684*035#6000	A	0.68	35	85	23	125	0.3	4	6000	112	101	45	1
TRJA105*035#RJ	A	1	35	85	23	125	0.3	4	6630	106	96	43	1
TRJA105*035#3000	A	1	35	85	23	125	0.3	4	3000	158	142	63	1
TRJB105*035#RJ	B	1	35	85	23	125	0.3	4	3400	158	142	63	1
TRJB105*035#2000	B	1	35	85	23	125	0.3	4	2000	206	186	82	1
TRJA155*035#RJ	A	1.5	35	85	23	125	0.39	6	3100	166	149	66	1
TRJA155*035#2000	A	1.5	35	85	23	125	0.39	6	2000	206	186	82	1
TRJB155*035#RJ	B	1.5	35	85	23	125	0.39	6	5460	125	112	50	1
TRJB155*035#2500	B	1.5	35	85	23	125	0.39	6	2500	184	166	74	1
TRJB225*035#RJ	B	2.2	35	85	23	125	0.58	6	4550	137	123	55	1
TRJB225*035#2000	B	2.2	35	85	23	125	0.58	6	2000	206	186	82	1
TRJB335*035#RJ	B	3.3	35	85	23	125	0.87	6	3740	151	136	60	1
TRJB335*035#1000	B	3.3	35	85	23	125	0.87	6	1000	292	262	117	1
TRJC335*035#RJ	C	3.3	35	85	23	125	0.87	6	1840	245	220	98	1
TRJC335*035#0800	C	3.3	35	85	23	125	0.87	6	800	371	334	148	1
TRJD335*035#RJ	D	3.3	35	85	23	125	0.87	6	2000	274	246	110	1 ¹⁾
TRJB475*035#RJ	B	4.7	35	85	23	125	1.2	6	2200	224	201	89	1
TRJB475*035#1500	B	4.7	35	85	23	125	1.2	6	1500	271	244	108	1
TRJC475*035#RJ	C	4.7	35	85	23	125	1.2	6	1410	279	251	112	1
TRJC475*035#0600	C	4.7	35	85	23	125	1.2	6	600	428	385	171	1
TRJD475*035#RJ	D	4.7	35	85	23	125	1.2	6	1500	316	285	126	1 ¹⁾
TRJC685*035#RJ	C	6.8	35	85	23	125	1.8	6	1070	321	289	128	1
TRJC685*035#0600	C	6.8	35	85	23	125	1.8	6	600	428	385	171	1
TRJD685*035#RJ	D	6.8	35	85	23	125	1.8	6	1300	340	306	136	1 ¹⁾
TRJC106*035#RJ	C	10	35	85	23	125	2.6	6	800	371	334	148	1
TRJC106*035#0600	C	10	35	85	23	125	2.6	6	600	428	385	171	1
TRJD106*035#RJ	D	10	35	85	23	125	2.6	6	800	433	390	173	1 ¹⁾
TRJD106*035#0250	D	10	35	85	23	125	2.6	6	250	775	697	310	1 ¹⁾
TRJD106*035#0400	D	10	35	85	23	125	2.6	6	400	612	551	245	1 ¹⁾
TRJD156*035#RJ	D	15	35	85	23	125	3.9	6	720	456	411	183	1 ¹⁾
TRJD156*035#0225	D	15	35	85	23	125	3.9	6	225	816	735	327	1 ¹⁾
TRJD226*035#RJ	D	22	35	85	23	125	5.8	6	650	480	432	192	1 ¹⁾
TRJD226*035#0200	D	22	35	85	23	125	5.8	6	200	866	779	346	1 ¹⁾
TRJD226*035#0400	D	22	35	85	23	125	5.8	6	400	612	551	245	1 ¹⁾
TRJE336*035#RJ	E	33	35	85	23	125	8.7	6	590	529	476	212	1 ¹⁾
TRJE336*035#0150	E	33	35	85	23	125	8.7	6	150	1049	944	420	1 ¹⁾
TRJE336*035#0250	E	33	35	85	23	125	8.7	6	250	812	731	325	1 ¹⁾
TRJU476*035RRJV	U	47	35	85	23	125	12.3	10	400	642	578	257	3
TRJU476*035R0200V	U	47	35	85	23	125	12.3	10	200	908	8.17	363	3
50 Volt @ 85°C													
TRJA224*050#RJ	A	0.22	50	85	33	125	0.3	4	7500	100	90	40	1
TRJA224*050#7000	A	0.22	50	85	33	125	0.3	4	7000	104	93	41	1
TRJA334*050#RJ	A	0.33	50	85	33	125	0.3	4	7000	104	93	41	1
TRJB474*050#RJ	B	0.47	50	85	33	125	0.3	4	5000	130	117	52	1
TRJB684*050#RJ	B	0.68	50	85	33	125	0.3	4	4000	146	131	58	1
TRJB684*050#2000	B	0.68	50	85	33	125	0.3	4	2000	206	186	82	1
TRJB105*050#RJ	B	1	50	85	33	125	0.4	4	3400	158	142	63	1
TRJB105*050#2000	B	1	50	85	33	125	0.4	4	2000	206	186	82	1
TRJC105*050#RJ	C	1	50	85	33	125	0.4	4	3000	191	172	77	1
TRJC155*050#RJ	C	1.5	50	85	33	125	0.6	6	2500	210	189	84	1
TRJC155*050#1500	C	1.5	50	85	33	125	0.6	6	1500	271	244	108	1
TRJC225*050#RJ	C	2.2	50	85	33	125	0.8	6	1700	254	229	102	1
TRJC225*050#1000	C	2.2	50	85	33	125	0.8	6	1000	332	298	133	1
TRJD225*050#RJ	D	2.2	50	85	33	125	0.8	4.5	2000	274	246	110	1 ¹⁾

TRJ Series

Professional Tantalum Chip Capacitor

RATINGS & PART NUMBER REFERENCE

Part Number	Case Size	Capacitance (µF)	Rated Voltage (V)	Rated Temperature (°C)	Category Voltage (V)	Category Temperature (°C)	DCL Max. (µA)	DF Max. (%)	ESR Max. @ 100kHz (mΩ)	100kHz RMS Current (mA)			MSL
										25°C	85°C	125°C	
TRJD225*050#1200	D	2.2	50	85	33	125	0.8	4.5	1200	354	318	141	1 ¹⁾
TRJC335*050#RJ	C	3.3	50	85	33	125	1.2	6	1400	280	252	112	1
TRJC335*050#1000	C	3.3	50	85	33	125	1.2	6	1000	332	298	133	1
TRJD335*050#RJ	D	3.3	50	85	33	125	1.2	4.5	1100	369	332	148	1 ¹⁾
TRJD335*050#0800	D	3.3	50	85	33	125	1.2	4.5	800	433	390	173	1 ¹⁾
TRJD475*050#RJ	D	4.7	50	85	33	125	1.8	4.5	900	408	367	163	1 ¹⁾
TRJD475*050#0600	D	4.7	50	85	33	125	1.8	4.5	600	500	450	200	1 ¹⁾
TRJD685*050#RJ	D	6.8	50	85	33	125	2.6	4.5	700	463	417	185	1 ¹⁾
TRJE106*050#RJ	E	10	50	85	33	125	3.8	4.5	700	486	437	194	1 ¹⁾
TRJE106*050#0300	E	10	50	85	33	125	3.8	4.5	300	742	667	297	1 ¹⁾
TRJE106*050#0400	E	10	50	85	33	125	3.8	4.5	400	642	578	257	1 ¹⁾
TRJU156*050RRJV	U	15	50	85	33	125	5.6	30	500	574	517	230	3
TRJU226*050RRJV	U	22	50	85	33	125	8.2	30	500	574	517	230	3

1¹⁾ Dry pack option (see How to order) is recommended for reduction of stress during soldering. Dry pack parts are treated as MSL 3.

Moisture Sensitivity Level (MSL) is defined according to J-STD-020.

All technical data relates to an ambient temperature of +25°C. Capacitance and DF are measured at 120Hz, 0.5V RMS with a maximum DC bias of 2.2 volts.

DCL is measured at rated voltage after 5 minutes.

The EIA & CECC standards for low ESR Solid Tantalum Capacitors allow an ESR movement to 1.25 times catalogue limit post mounting.

For typical weight and composition see page 253.

NOTE: KYOCERA AVX reserves the right to supply higher voltage ratings or tighter tolerance part in the same case size, to the same reliability standards.

TRJ Series

Professional Tantalum Chip Capacitor

QUALIFICATION TABLE

TEST	TRJ professional series (Temperature range -55°C to +125°C)									
	Condition			Characteristics						
Endurance	Apply rated voltage (Ur) at 85°C and / or category voltage (Uc) at 125°C for 2000 hours through a circuit impedance of $\leq 0.1\Omega/V$. Stabilize at room temperature for 1-2 hours before measuring.			Visual examination	no visible damage					
				DCL	1.25 x initial limit					
				$\Delta C/C$	within $\pm 10\%$ of initial value					
				DF	initial limit					
				ESR	1.25 x initial limit					
Storage Life	Store at 125°C, no voltage applied, for 2000 hours. Stabilize at room temperature for 1-2 hours before measuring.			Visual examination	no visible damage					
				DCL	1.25 x initial limit					
				$\Delta C/C$	within $\pm 10\%$ of initial value					
				DF	initial limit					
				ESR	1.25 x initial limit					
Humidity	Store at 65°C and 95% relative humidity for 500 hours, with no applied voltage. Stabilize at room temperature and humidity for 1-2 hours before measuring.			Visual examination	no visible damage					
				DCL	1.5 x initial limit					
				$\Delta C/C$	within $\pm 10\%$ of initial value					
				DF	1.2 x initial limit					
				ESR	1.25 x initial limit					
Biased Humidity	Apply rated voltage (Ur) at 85°C, 85% relative humidity for 1000 hours. Stabilize at room temperature and humidity for 1-2 hours before measuring.			Visual examination	no visible damage					
				DCL	2 x initial limit					
				$\Delta C/C$	within $\pm 10\%$ of initial value					
				DF	1.2 x initial limit					
				ESR	1.25 x initial limit					
Temperature Stability	Step	Temperature°C	Duration(min)		+20°C	-55°C	+20°C	+85°C	+125°C	+20°C
	1	+20	15							
	2	-55	15	DCL	IL*	n/a	IL*	10 x IL*	12.5 x IL*	IL*
	3	+20	15	$\Delta C/C$	n/a	+0/-10%	$\pm 5\%$	+10/-0%	+12/-0%	$\pm 5\%$
	4	+85	15	DF	IL*	1.5 x IL*	IL*	1.5 x IL*	2 x IL*	IL*
	5	+125	15							
	6	+20	15	ESR	1.25xIL*	2.5xIL*	1.25xIL*	1.25xIL*	1.25xIL*	1.25xIL*
Surge Voltage	Apply 1.3x category voltage (Uc) at 125°C for 1000 cycles of duration 6 min (30 sec charge, 5 min 30 sec discharge) through a charge / discharge resistance of 1000 Ω			Visual examination	no visible damage					
				DCL	initial limit					
				$\Delta C/C$	within $\pm 5\%$ of initial value					
				DF	initial limit					
				ESR	1.25 x initial limit					
Mechanical Shock	MIL-STD-202, Method 213, Condition F			Visual examination	no visible damage					
				DCL	initial limit					
				$\Delta C/C$	within $\pm 5\%$ of initial value					
				DF	initial limit					
				ESR	1.25 x initial limit					
Vibration	MIL-STD-202, Method 204, Condition D			Visual examination	no visible damage					
				DCL	initial limit					
				$\Delta C/C$	within $\pm 5\%$ of initial value					
				DF	initial limit					
				ESR	1.25 x initial limit					

*Initial Limit

TRJ Series

Professional Tantalum Chip Capacitor

SOLID ELECTROLYTIC CAPACITOR ROADMAP

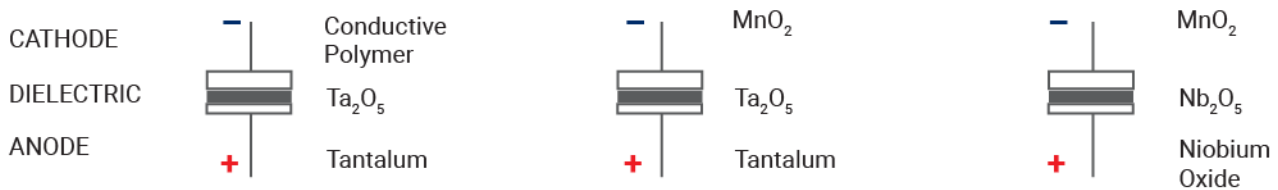
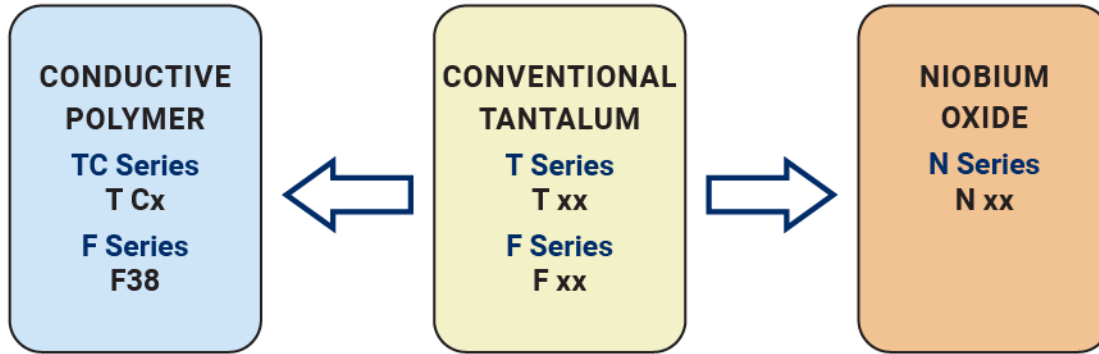

FIVE CAPACITOR CONSTRUCTION STYLES

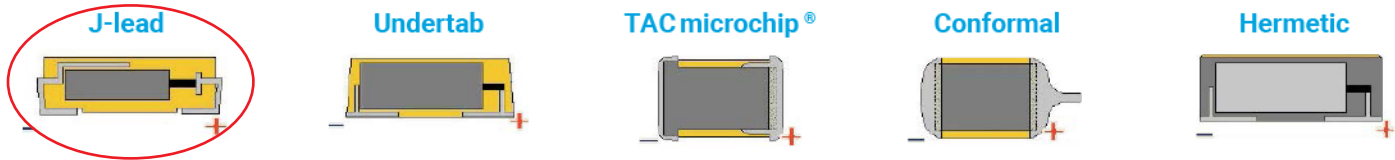

SERIES LINE UP : CONVENTIONAL SMD MnO₂

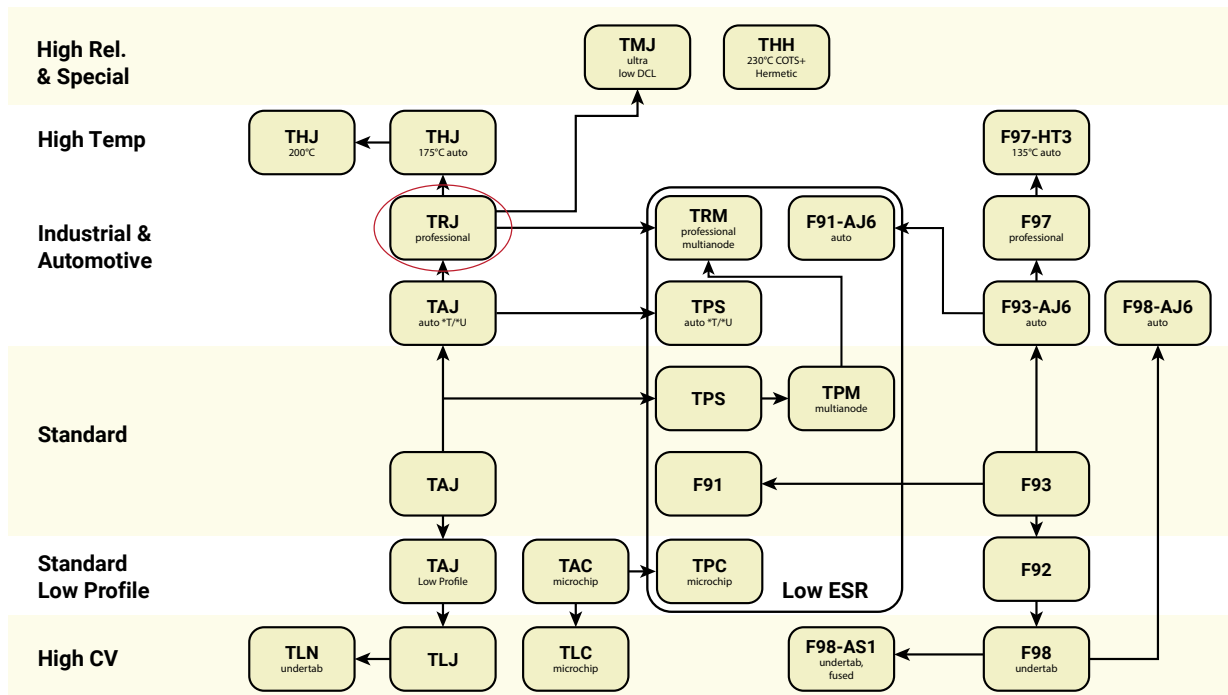

OUR CERTIFICATE

DiGi provide top-quality products and perfect service for customer worldwide through standardization, technological innovation and continuous improvement. DiGi through third-party certification, we stricly control the quality of products and services. Welcome your RFQ to

Email: Info@DiGi-Electronics.com



Tel: +00 852-30501935

RFQ Email: Info@DiGi-Electronics.com

DiGi is a global authorized distributor of electronic components.