

AD8691WAUJZ-R7 Datasheet

www.digi-electronics.com

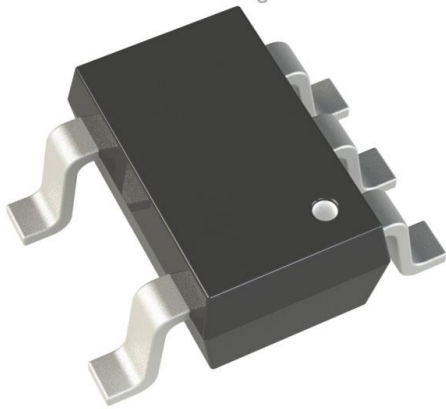

<https://www.DiGi-Electronics.com>

DiGi Electronics Part Number	AD8691WAUJZ-R7-DG
Manufacturer	Analog Devices Inc.
Manufacturer Product Number	AD8691WAUJZ-R7
Description	IC OPAMP GP 1 CIRCUIT TSOT23-5
Detailed Description	General Purpose Amplifier 1 Circuit Rail-to-Rail TSO T-23-5



Tel: +00 852-30501935

RFQ Email: Info@DiGi-Electronics.com

DiGi is a global authorized distributor of electronic components.

Purchase and inquiry

Manufacturer Product Number:

AD8691WAUJZ-R7

Series:

-

Amplifier Type:

General Purpose

Output Type:

Rail-to-Rail

Gain Bandwidth Product:

10 MHz

Voltage - Input Offset:

400 μ V

Current - Output / Channel:

80 mA

Voltage - Supply Span (Max):

6 V

Grade:

Automotive

Package / Case:

SOT-23-5 Thin, TSOT-23-5

Base Product Number:

AD8691

Manufacturer:

Analog Devices Inc.

Product Status:

Active

Number of Circuits:

1

Slew Rate:

5V/ μ s

Current - Input Bias:

200 nA

Current - Supply:

950 μ A

Voltage - Supply Span (Min):

2.7 V

Operating Temperature:

-40°C ~ 125°C

Mounting Type:

Surface Mount

Supplier Device Package:

TSOT-23-5

Environmental & Export classification

RoHS Status:

ROHS3 Compliant

REACH Status:

REACH Unaffected

HTSUS:

8542.33.0001

Moisture Sensitivity Level (MSL):

1 (Unlimited)

ECCN:

EAR99



Low Cost, Low Noise, CMOS, RRO Operational Amplifiers

Data Sheet

AD8691/AD8692/AD8694

FEATURES

- Offset voltage: 400 μ V typical**
- Low offset voltage drift: 6 μ V/ $^{\circ}$ C maximum (AD8692/AD8694)**
- Very low input bias currents: 1 pA maximum**
- Low noise: 8 nV/ $\sqrt{\text{Hz}}$**
- Low distortion: 0.0006%**
- Wide bandwidth: 10 MHz**
- Unity-gain stable**
- Single-supply operation: 2.7 V to 6 V**
- Qualified for automotive applications**

APPLICATIONS

- Photodiode amplification**
- Battery-powered instrumentation**
- Medical instruments**
- Multipole filters**
- Sensors**
- Portable audio devices**

GENERAL DESCRIPTION

The AD8691, AD8692, and AD8694 are low cost, single, dual, and quad rail-to-rail output, single-supply amplifiers featuring low offset and input voltages, low current noise, and wide signal bandwidth. The combination of low offset, low noise, very low input bias currents, and high speed make these amplifiers useful in a wide variety of applications. Filters, integrators, photodiode amplifiers, and high impedance sensors all benefit from this combination of performance features. Audio and other ac applications benefit from the wide bandwidth and low distortion of these devices.

Applications for these amplifiers include power amplifier (PA) controls, laser diode control loops, portable and loop-powered instrumentation, audio amplification for portable devices, and ASIC input and output amplifiers.

The small SC70 and TSOT package options for the AD8691 allow it to be placed next to sensors, thereby reducing external noise pickup.

The AD8691, AD8692, and AD8694 are specified over the extended industrial temperature range of -40°C to $+125^{\circ}\text{C}$. The AD8691 single is available in 5-lead SC70 and 5-lead TSOT packages. The AD8692 dual is available in 8-lead MSOP and narrow SOIC surface-mount packages. The AD8694 quad is available in 14-lead TSSOP and narrow 14-lead SOIC packages.

See the Ordering Guide section for automotive grades.

PIN CONFIGURATIONS

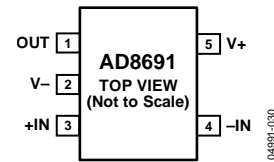

Figure 1. 5-Lead TSOT

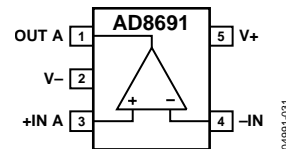

Figure 2. 5-Lead SC70

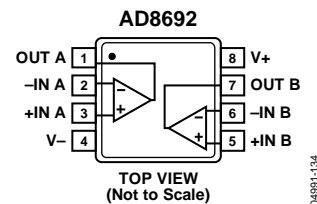

Figure 3. 8-Lead SOIC and 8-Lead MSOP

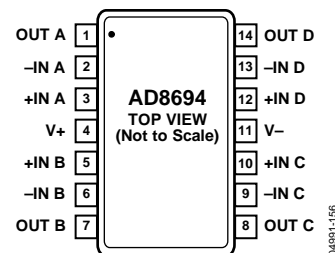

Figure 4. 14-Lead SOIC and 14-Lead TSSOP

Rev. F

[Document Feedback](#)

Information furnished by Analog Devices is believed to be accurate and reliable. However, no responsibility is assumed by Analog Devices for its use, nor for any infringements of patents or other rights of third parties that may result from its use. Specifications subject to change without notice. No license is granted by implication or otherwise under any patent or patent rights of Analog Devices. Trademarks and registered trademarks are the property of their respective owners.

One Technology Way, P.O. Box 9106, Norwood, MA 02062-9106, U.S.A.
Tel: 781.329.4700 ©2004–2013 Analog Devices, Inc. All rights reserved.
[Technical Support](#) www.analog.com

TABLE OF CONTENTS

Features	1
Applications.....	1
General Description	1
Pin Configurations	1
Revision History	2
Specifications.....	3
Electrical Characteristics	3

REVISION HISTORY

9/13—Rev. E to Rev. F

Changes to Figure 3 and Figure 4.....	1
Delete Figure 4 and Figure 5; Renumbered Sequentially	1
Changes to Ordering Guide	14

8/11—Rev. D to Rev. E

Changes to Figure 20.....	8
---------------------------	---

11/10—Rev. C to Rev. D

Changes to Features Section and General Descriptions Section.....	1
Updated Outline Dimensions	11
Changes to Ordering Guide	14
Added Automotive Products Section	14

5/07—Rev. B to Rev. C

Change to Figure 1	1
Changes to Large Signal Voltage Gain Values in Table 1	3
Change to Phase Margin Symbol in Table 1	3
Change to T_A Value for Table 2.....	4
Changes to Large Signal Voltage Gain Values in Table 2	4
Change to Phase Margin Symbol in Table 2	4
Changes to Table 4.....	5
Changes to Outline Dimensions.....	11
Changes to Ordering Guide	12

Absolute Maximum Ratings	5
Thermal Characteristics	5
ESD Caution.....	5
Typical Performance Characteristics	6
Outline Dimensions	11
Ordering Guide	14
Automotive Products.....	14

3/05—Rev. A to Rev. B

Added AD8694	Universal
--------------------	-----------

1/05—Rev. 0 to Rev. A

Added AD8691	Universal
Changes to Features	1
Added Figure 1 and Figure 2.....	1
Changes to Electrical Characteristics	3
Changes to Figure 6 caption.....	6
Changes to Figure 9.....	6
Updated Outline Dimensions	11
Changes to Ordering Guide	11

10/04—Revision 0: Initial Version

SPECIFICATIONS

ELECTRICAL CHARACTERISTICS

$V_S = 2.7\text{ V}$, $V_{CM} = V_S/2$, $T_A = 25^\circ\text{C}$, unless otherwise noted.

Table 1.

Parameter	Symbol	Test Conditions/Comments	Min	Typ	Max	Unit
INPUT CHARACTERISTICS						
Offset Voltage	V_{OS}	$V_{CM} = -0.3\text{ V to }+1.6\text{ V}$ $V_{CM} = -0.1\text{ V to }+1.6\text{ V}; -40^\circ\text{C} < T_A < +125^\circ\text{C}$		0.4	2.0	mV
Input Bias Current	I_B	$-40^\circ\text{C} < T_A < +85^\circ\text{C}$ $-40^\circ\text{C} < T_A < +125^\circ\text{C}$		0.2	1	pA
Input Offset Current	I_{OS}	$-40^\circ\text{C} < T_A < +85^\circ\text{C}$ $-40^\circ\text{C} < T_A < +125^\circ\text{C}$		0.1	0.5	pA
Input Voltage Range			-0.3		+1.6	V
Common-Mode Rejection Ratio	CMRR	$V_{CM} = -0.3\text{ V to }+1.6\text{ V}$ $V_{CM} = -0.1\text{ V to }+1.6\text{ V}; -40^\circ\text{C} < T_A < +125^\circ\text{C}$	68	90		dB
Large Signal Voltage Gain	A_{VO}	$R_L = 2\text{ k}\Omega$, $V_O = 0.5\text{ V to }2.2\text{ V}$ $R_L = 2\text{ k}\Omega$, $V_O = 0.5\text{ V to }2.2\text{ V}$	90	250		V/mV
Offset Voltage Drift	$\Delta V_{OS}/\Delta T$			2	12	$\mu\text{V}/^\circ\text{C}$
				1.3	6	$\mu\text{V}/^\circ\text{C}$
INPUT CAPACITANCE						
Common-Mode Input Capacitance	C_{CM}			5		pF
Differential Input Capacitance	C_{DM}			2.5		pF
OUTPUT CHARACTERISTICS						
Output Voltage High	V_{OH}	$I_L = 1\text{ mA}$ $-40^\circ\text{C} < T_A < +125^\circ\text{C}$	2.64	2.66		V
Output Voltage Low	V_{OL}	$I_L = 1\text{ mA}$ $-40^\circ\text{C} < T_A < +125^\circ\text{C}$	2.6	25	40	mV
Short-Circuit Current	I_{SC}			± 20	60	mV
Closed-Loop Output Impedance	Z_{OUT}	$f = 1\text{ MHz}$, $A_v = 1$		12		Ω
POWER SUPPLY						
Power Supply Rejection Ratio	PSRR	$V_S = 2.7\text{ V to }5.5\text{ V}$ $-40^\circ\text{C} < T_A < +125^\circ\text{C}$	80	95		dB
Supply Current/Amplifier	I_{SY}	$V_O = 0\text{ V}$ $-40^\circ\text{C} < T_A < +125^\circ\text{C}$	75	95		dB
				0.85	0.95	mA
					1.2	mA
DYNAMIC PERFORMANCE						
Slew Rate	SR	$R_L = 2\text{ k}\Omega$		5		V/ μs
Settling Time	t_S	To 0.01%		1		μs
Gain Bandwidth Product	GBP			10		MHz
Phase Margin	ϕ_m			60		Degrees
Total Harmonic Distortion + Noise	THD + N	$G = 1$, $R_L = 600\ \Omega$, $f = 1\text{ kHz}$, $V_O = 250\text{ mV p-p}$		0.003		%
NOISE PERFORMANCE						
Voltage Noise	$e_{n\text{ p-p}}$	$f = 0.1\text{ Hz to }10\text{ Hz}$		1.6	3.0	$\mu\text{V p-p}$
Voltage Noise Density	e_n	$f = 1\text{ kHz}$		8	12	nV/ $\sqrt{\text{Hz}}$
	e_n	$f = 10\text{ kHz}$		6.5		nV/ $\sqrt{\text{Hz}}$
Current Noise Density	i_n	$f = 1\text{ kHz}$		0.05		pA/ $\sqrt{\text{Hz}}$

AD8691/AD8692/AD8694

Data Sheet

$V_S = 5.0\text{ V}$, $V_{CM} = V_S/2$, $T_A = 25^\circ\text{C}$, unless otherwise noted.

Table 2.

Parameter	Symbol	Test Conditions/Comments	Min	Typ	Max	Unit
INPUT CHARACTERISTICS						
Offset Voltage	V_{OS}	$V_{CM} = -0.3\text{ V to }+3.9\text{ V}$ $V_{CM} = -0.1\text{ V to }+3.9\text{ V}; -40^\circ\text{C} < T_A < +125^\circ\text{C}$		0.4	2.0	mV
Input Bias Current	I_B	$-40^\circ\text{C} < T_A < +85^\circ\text{C}$ $-40^\circ\text{C} < T_A < +125^\circ\text{C}$		0.2	1	pA
Input Offset Current	I_{OS}	$-40^\circ\text{C} < T_A < +85^\circ\text{C}$ $-40^\circ\text{C} < T_A < +125^\circ\text{C}$		0.1	0.5	pA
Input Voltage Range			-0.3		+3.9	V
Common-Mode Rejection Ratio	CMRR	$V_{CM} = -0.3\text{ V to }+3.9\text{ V}$ $V_{CM} = -0.1\text{ V to }+3.9\text{ V}; -40^\circ\text{C} < T_A < +125^\circ\text{C}$	70	95		dB
Large Signal Voltage Gain	A_{VO}	$V_O = 0.5\text{ V to }4.5\text{ V}$, $R_L = 2\text{ k}\Omega$, $V_{CM} = 0\text{ V}$ $V_O = 0.5\text{ V to }4.5\text{ V}$, $R_L = 2\text{ k}\Omega$, $V_{CM} = 0\text{ V}$	250	2000		V/mV
Offset Voltage Drift	$\Delta V_{OS}/\Delta T$			2	12	$\mu\text{V}/^\circ\text{C}$
				1.3	6	$\mu\text{V}/^\circ\text{C}$
INPUT CAPACITANCE						
Common-Mode Input Capacitance	C_{CM}			5		pF
Differential Input Capacitance	C_{DM}			2.5		pF
OUTPUT CHARACTERISTICS						
Output Voltage High	V_{OH}	$I_L = 1\text{ mA}$ $I_L = 10\text{ mA}$ $-40^\circ\text{C to }+125^\circ\text{C}$	4.96	4.98		V
			4.7	4.78		V
			4.6			V
Output Voltage Low	V_{OL}	$I_L = 1\text{ mA}$ $I_L = 10\text{ mA}$ $I_L = 10\text{ mA}$ $-40^\circ\text{C to }+125^\circ\text{C}$ $-40^\circ\text{C to }+125^\circ\text{C}$		20	40	mV
				165	210	mV
				185	240	mV
					290	mV
					370	mV
Short-Circuit Current	I_{SC}			± 80		mA
Closed-Loop Output Impedance	Z_{OUT}	$f = 1\text{ MHz}$, $A_V = 1$		10		Ω
POWER SUPPLY						
Power Supply Rejection Ratio	PSRR	$V_S = 2.7\text{ V to }5.5\text{ V}$ $-40^\circ\text{C} < T_A < +125^\circ\text{C}$	80	95		dB
			75	95		dB
Supply Current/Amplifier	I_{SY}	$V_O = 0\text{ V}$ $-40^\circ\text{C} < T_A < +125^\circ\text{C}$		0.95	1.05	mA
					1.3	mA
DYNAMIC PERFORMANCE						
Slew Rate	SR	$R_L = 2\text{ k}\Omega$		5		V/ μs
Settling Time	t_S	To 0.01%		1		μs
Full Power Bandwidth	BW_P	<1% distortion		360		kHz
Gain Bandwidth Product	GBP			10		MHz
Phase Margin	ϕ_m			65		Degrees
Total Harmonic Distortion + Noise	THD + N	$G = 1$, $R_L = 600\ \Omega$, $f = 1\text{ kHz}$, $V_O = 1\text{ V p-p}$		0.0006		%
NOISE PERFORMANCE						
Voltage Noise	$e_{n\text{ p-p}}$	$f = 0.1\text{ Hz to }10\text{ Hz}$		1.6	3.0	$\mu\text{V p-p}$
Voltage Noise Density	e_n	$f = 1\text{ kHz}$		8	12	nV/ $\sqrt{\text{Hz}}$
	e_n	$f = 10\text{ kHz}$		6.5		nV/ $\sqrt{\text{Hz}}$
Current Noise Density	i_n	$f = 1\text{ kHz}$		0.05		pA/ $\sqrt{\text{Hz}}$

ABSOLUTE MAXIMUM RATINGS

$T_A = 25^\circ\text{C}$, unless otherwise noted.

Table 3.

Parameter	Rating
Supply Voltage	6 V
Input Voltage	$V_{SS} - 0.3\text{ V}$ to $V_{DD} + 0.3\text{ V}$
Differential Input Voltage	$\pm 6\text{ V}$
Output Short-Circuit Duration to GND	Observe derating curves
Storage Temperature Range	-65°C to $+150^\circ\text{C}$
Operating Temperature Range	-40°C to $+125^\circ\text{C}$
Junction Temperature Range	-65°C to $+150^\circ\text{C}$
Lead Temperature (Soldering, 60 sec)	300°C

Stresses above those listed under Absolute Maximum Ratings may cause permanent damage to the device. This is a stress rating only; functional operation of the device at these or any other conditions above those indicated in the operational section of this specification is not implied. Exposure to absolute maximum rating conditions for extended periods may affect device reliability.

THERMAL CHARACTERISTICS

θ_{JA} is specified for the worst-case conditions, that is, the device soldered in the circuit board for surface-mount packages.

Table 4. Thermal Resistance

Package Type	θ_{JA}	θ_{JC}	Unit
8-Lead MSOP (RM-8)	210	45	$^\circ\text{C}/\text{W}$
8-Lead SOIC (R-8)	158	43	$^\circ\text{C}/\text{W}$
5-Lead TSOT (UJ-5)	207	61	$^\circ\text{C}/\text{W}$
5-Lead SC70 (KS-5)	376	126	$^\circ\text{C}/\text{W}$
14-Lead TSSOP (RU-14)	180	35	$^\circ\text{C}/\text{W}$
14-Lead SOIC (R-14)	120	36	$^\circ\text{C}/\text{W}$

ESD CAUTION



ESD (electrostatic discharge) sensitive device. Charged devices and circuit boards can discharge without detection. Although this product features patented or proprietary protection circuitry, damage may occur on devices subjected to high energy ESD. Therefore, proper ESD precautions should be taken to avoid performance degradation or loss of functionality.

AD8691/AD8692/AD8694

Data Sheet

TYPICAL PERFORMANCE CHARACTERISTICS

$V_S = +5\text{ V}$ or $\pm 2.5\text{ V}$, unless otherwise noted.

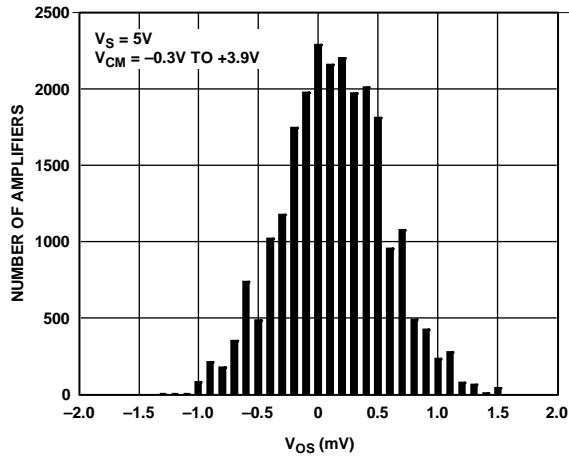

Figure 5. Input Offset Voltage Distribution

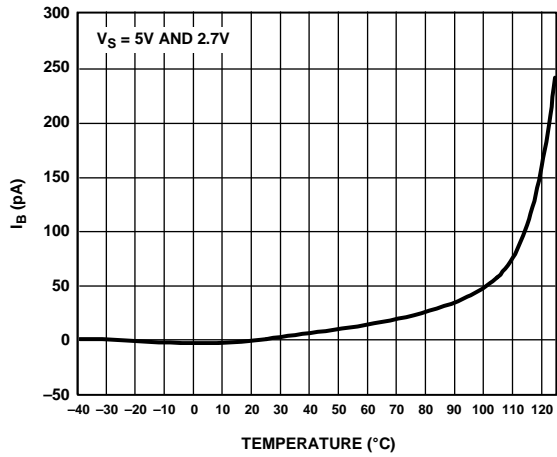

Figure 8. Input Bias Current vs. Temperature

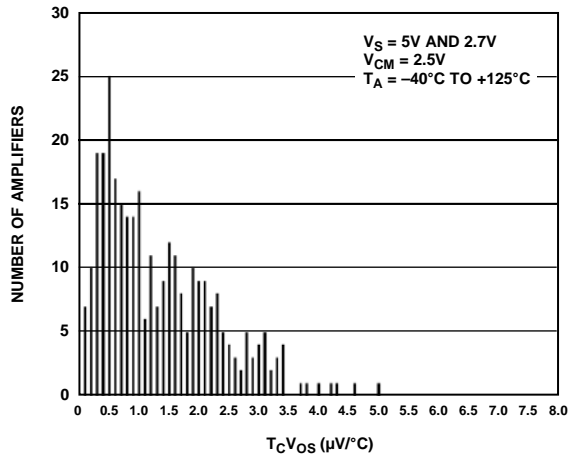

Figure 6. AD8692/AD8694 Input Offset Voltage Drift Distribution

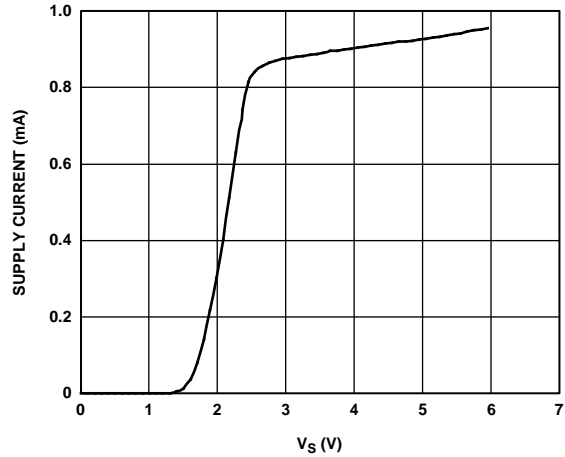

Figure 9. Supply Current vs. Supply Voltage

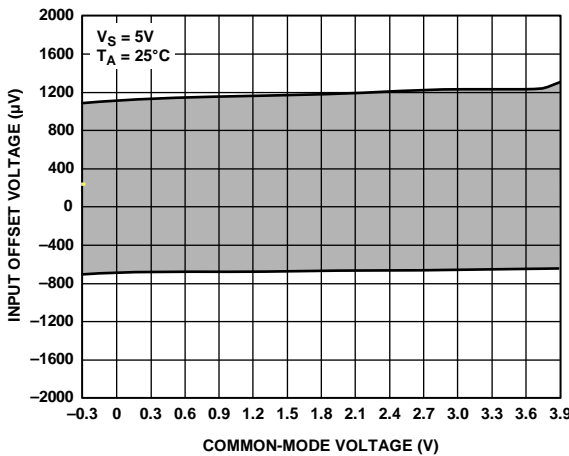

Figure 7. Input Offset Voltage vs. Common-Mode Voltage

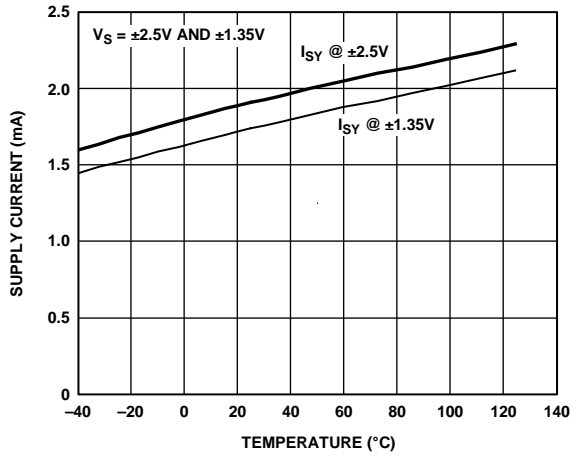

Figure 10. Supply Current vs. Temperature

Data Sheet

AD8691/AD8692/AD8694

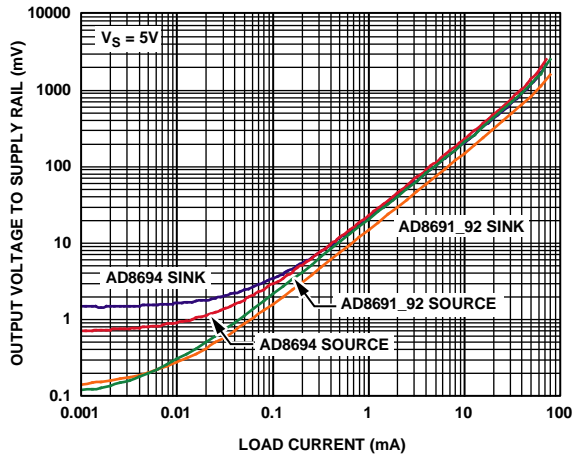

Figure 11. Output Voltage to Supply Rail vs. Load Current

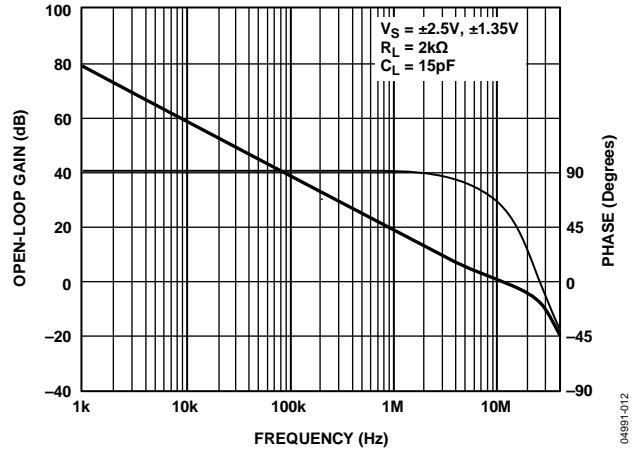

Figure 14. Open-Loop Gain and Phase vs. Frequency

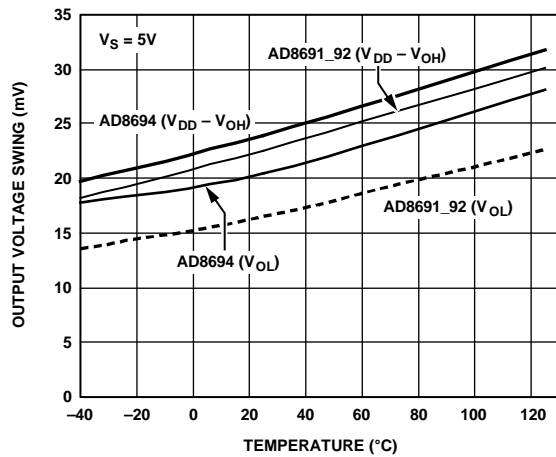

Figure 12. Output Voltage Swing vs. Temperature ($I_L = 1 \text{ mA}$)

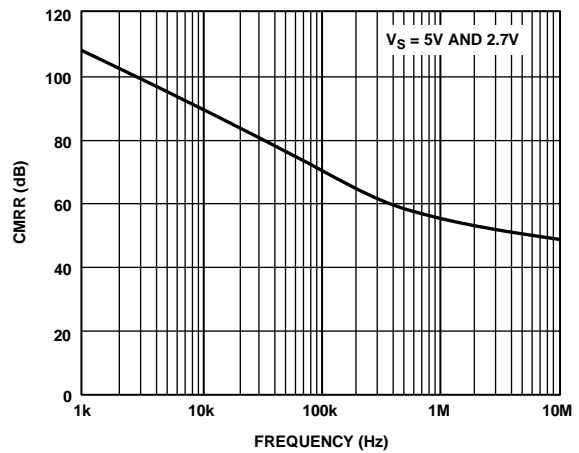

Figure 15. CMRR vs. Frequency

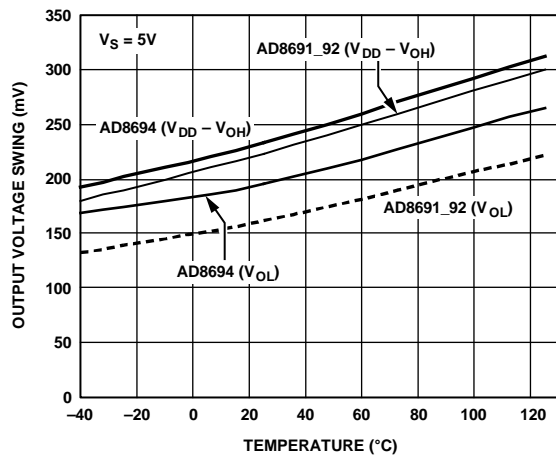

Figure 13. Output Voltage Swing vs. Temperature ($I_L = 10 \text{ mA}$)

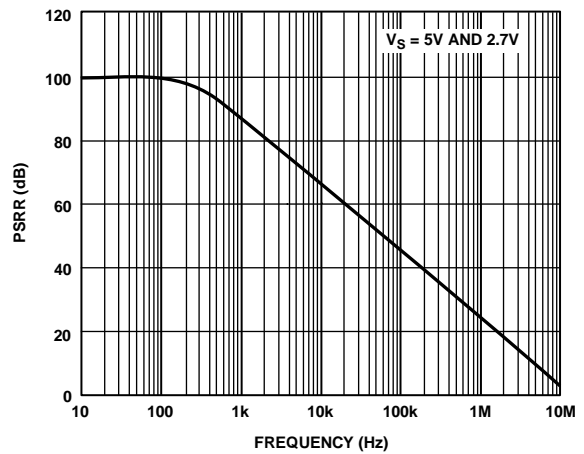

Figure 16. PSRR vs. Frequency

AD8691/AD8692/AD8694

Data Sheet

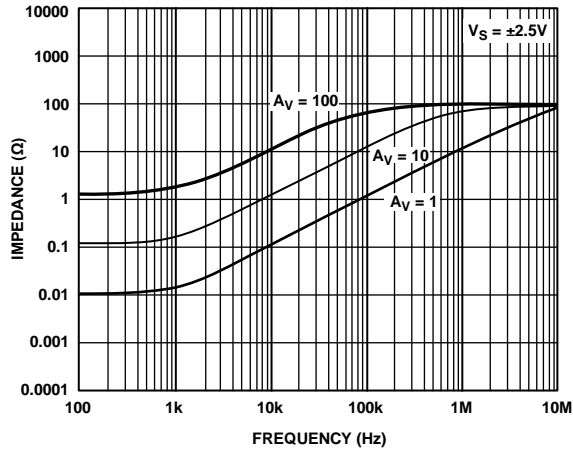

Figure 17. Closed-Loop Output Impedance vs. Frequency

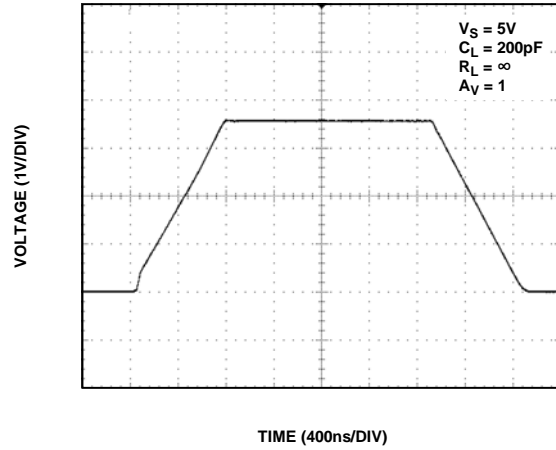

Figure 20. Large Signal Transient Response

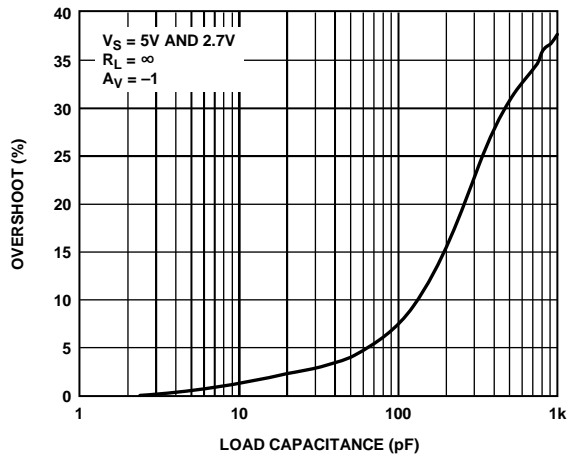

Figure 18. Small Signal Overshoot vs. Load Capacitance

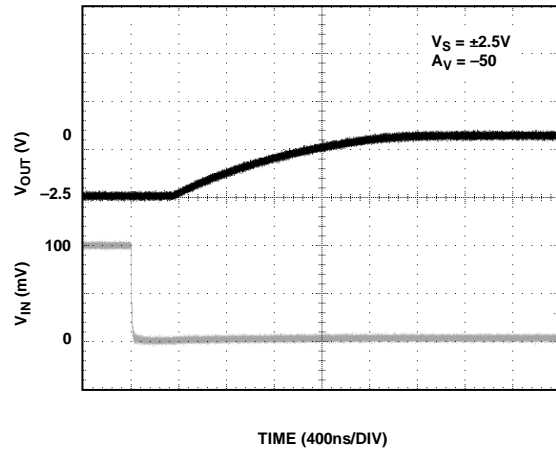

Figure 21. Positive Overload Recovery

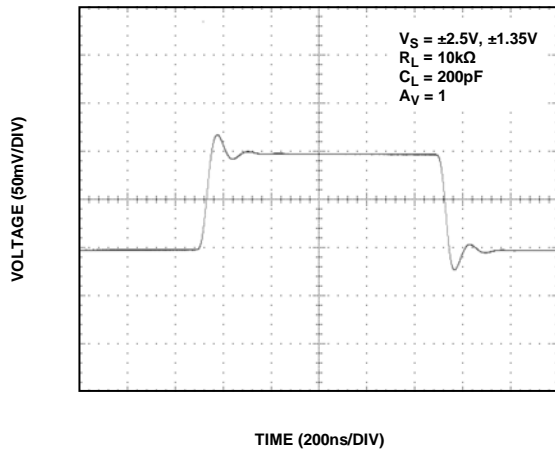

Figure 19. Small Signal Transient Response

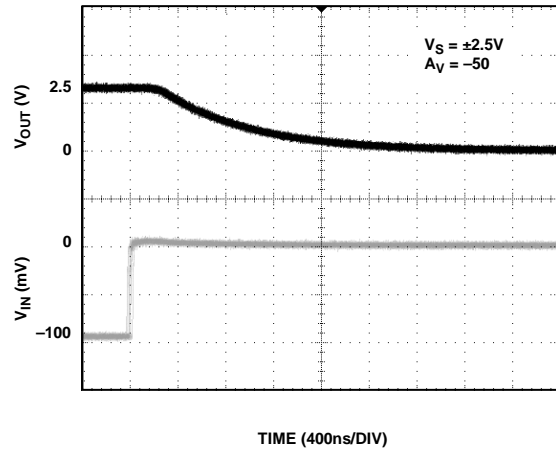

Figure 22. Negative Overload Recovery

Data Sheet

AD8691/AD8692/AD8694

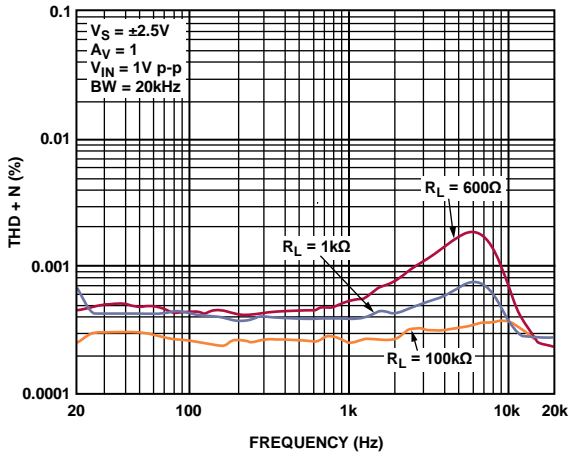

Figure 23. THD + N vs. Frequency

04891-021

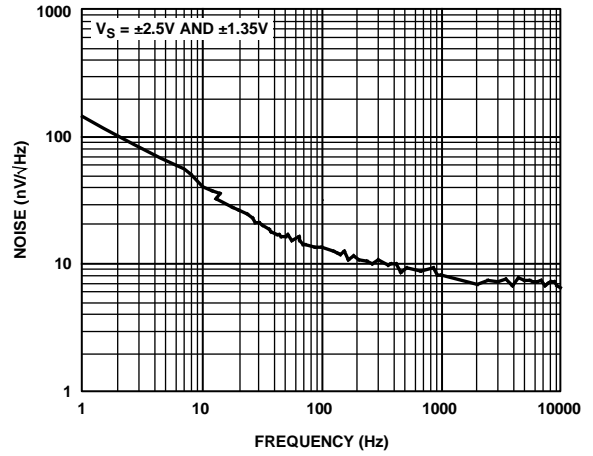

Figure 25. Voltage Noise Density

04891-023

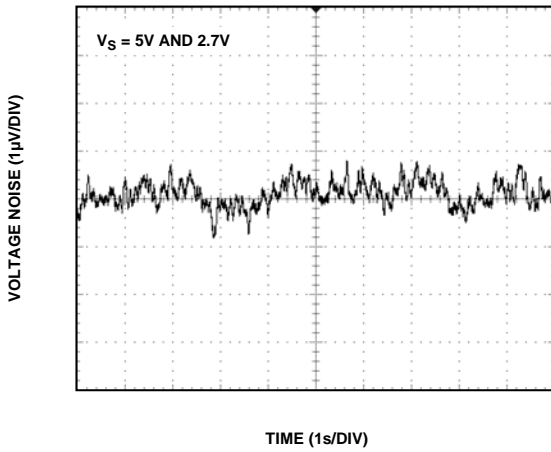

Figure 24. 0.1 Hz to 10 Hz Input Voltage Noise

04891-022

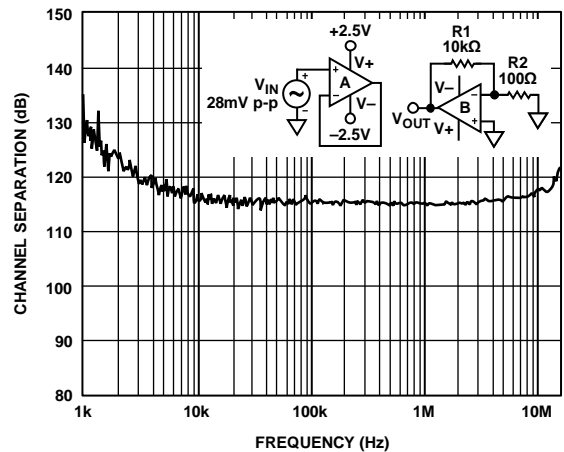

Figure 26. AD8692/AD8694 Channel Separation

04891-024

AD8691/AD8692/AD8694

Data Sheet

$V_S = +2.7\text{ V}$ or $\pm 1.35\text{ V}$, unless otherwise noted.

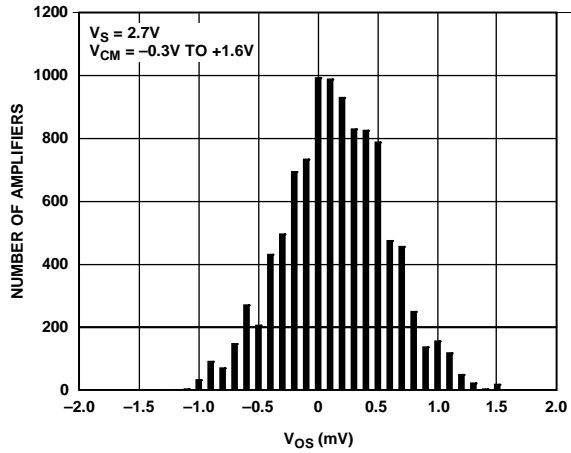

Figure 27. Input Offset Voltage Distribution

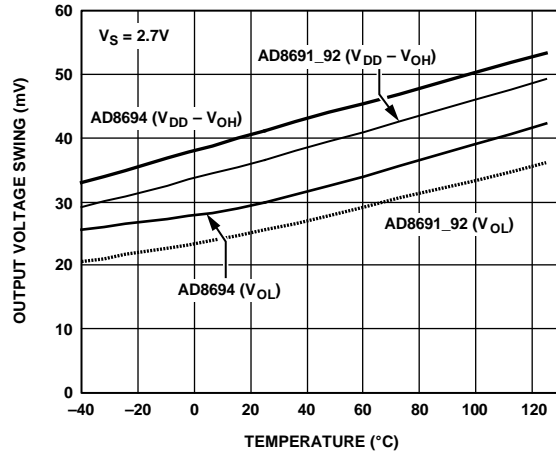

Figure 30. Output Voltage Swing vs. Temperature ($I_L = 1\text{ mA}$)

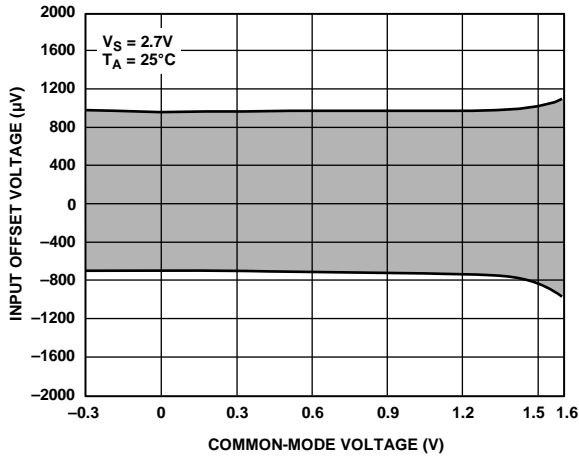

Figure 28. Input Offset Voltage vs. Common-Mode Voltage

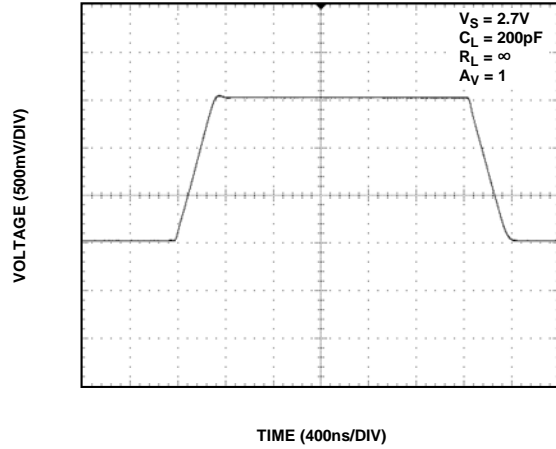

Figure 31. Large Signal Transient Response

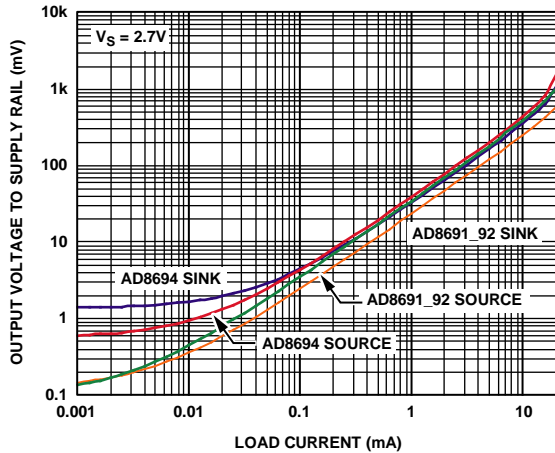

Figure 29. Output Voltage to Supply Rail vs. Load Current

04991-025

04991-028

04991-026

04991-023

04991-027

OUTLINE DIMENSIONS

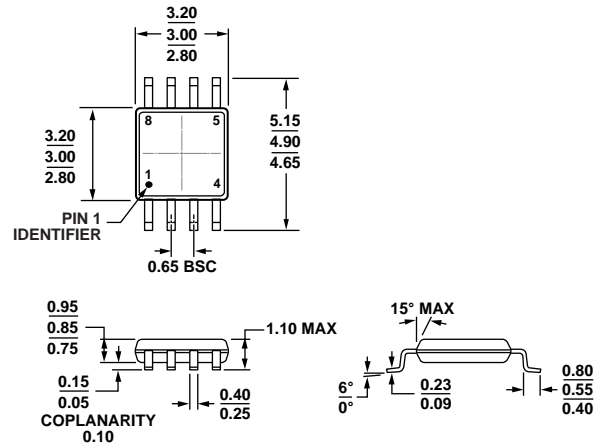

COMPLIANT TO JEDEC STANDARDS MO-187-AA

Figure 32. 8-Lead Mini Small Outline Package [MSOP] (RM-8)

Dimensions shown in millimeters

10-07-2008-B

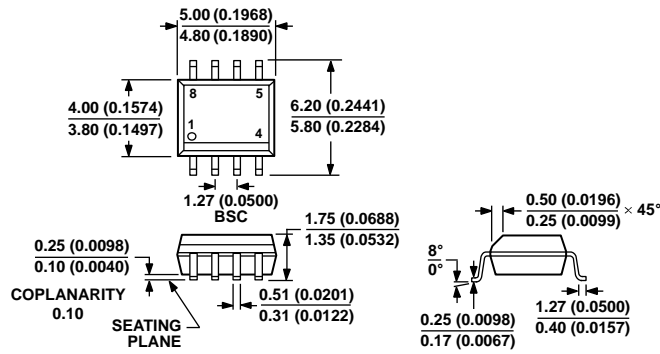

COMPLIANT TO JEDEC STANDARDS MS-012-AA

CONTROLLING DIMENSIONS ARE IN MILLIMETERS; INCH DIMENSIONS (IN PARENTHESES) ARE ROUNDED-OFF MILLIMETER EQUIVALENTS FOR REFERENCE ONLY AND ARE NOT APPROPRIATE FOR USE IN DESIGN.

Figure 33. 8-Lead Standard Small Outline Package [SOIC_N] Narrow Body (R-8)

Dimensions shown in millimeters and (inches)

012407-A

AD8691/AD8692/AD8694

Data Sheet

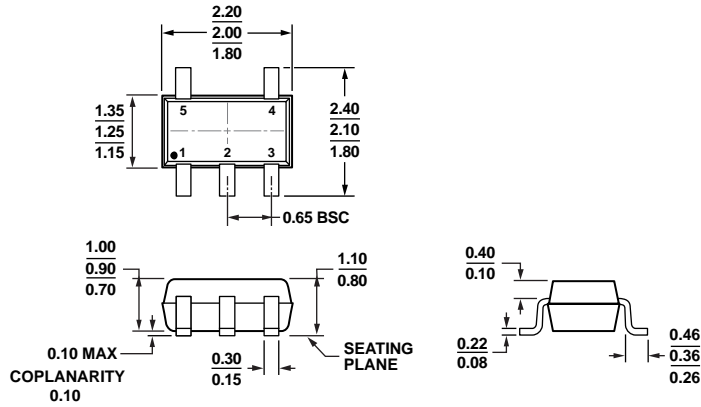

COMPLIANT TO JEDEC STANDARDS MO-203-AA

Figure 34. 5-Lead Thin Shrink Small Outline Package [SC70] (KS-5)

Dimensions shown in millimeters

072809-A

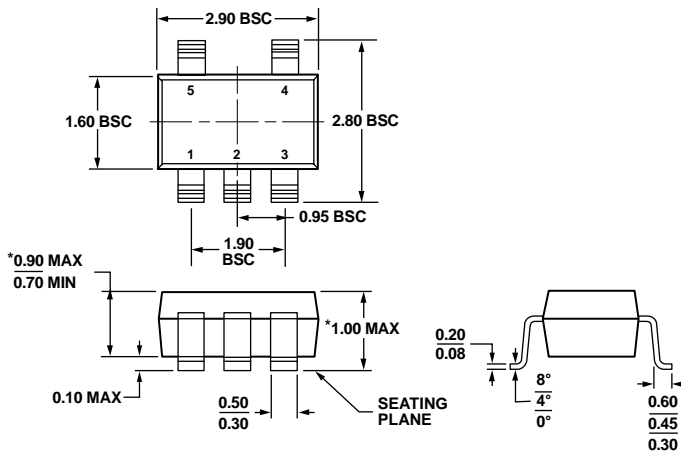

*COMPLIANT TO JEDEC STANDARDS MO-193-AB WITH THE EXCEPTION OF PACKAGE HEIGHT AND THICKNESS.

Figure 35. 5-Lead Thin Small Outline Transistor Package [TSOT] (UJ-5)

Dimensions shown in millimeters

100708-A

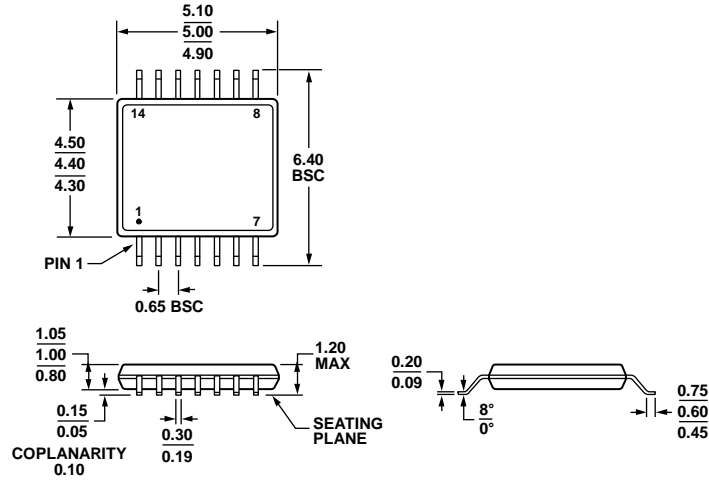

COMPLIANT TO JEDEC STANDARDS MO-153-AB-1

Figure 36. 14-Lead Thin Shrink Small Outline Package [TSSOP] (RU-14)

Dimensions shown in millimeters

061908-A

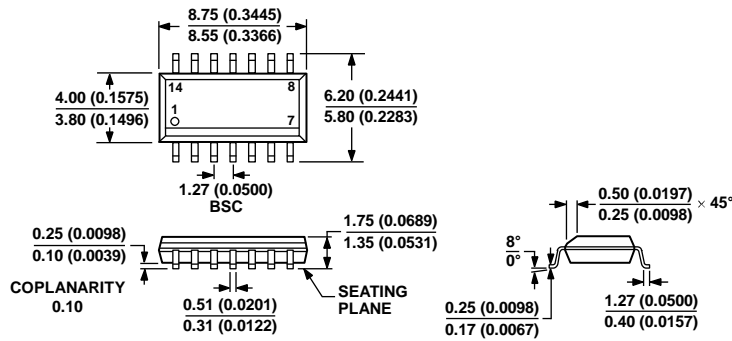

COMPLIANT TO JEDEC STANDARDS MS-012-AB
CONTROLLING DIMENSIONS ARE IN MILLIMETERS; INCH DIMENSIONS (IN PARENTHESES) ARE ROUNDED-OFF MILLIMETER EQUIVALENTS FOR REFERENCE ONLY AND ARE NOT APPROPRIATE FOR USE IN DESIGN.

Figure 37. 14-Lead Standard Small Outline Package [SOIC_N] Narrow Body (R-14)

Dimensions shown in millimeters and (inches)

061606-A

AD8691/AD8692/AD8694**Data Sheet****ORDERING GUIDE**

Model ^{1, 2}	Temperature Range	Package Description	Package Option	Branding
AD8691AUJZ-R2	-40°C to +125°C	5-Lead TSOT	UJ-5	ACA
AD8691AUJZ-REEL	-40°C to +125°C	5-Lead TSOT	UJ-5	ACA
AD8691AUJZ-REEL7	-40°C to +125°C	5-Lead TSOT	UJ-5	ACA
AD8691AKSZ-R2	-40°C to +125°C	5-Lead SC70	KS-5	ACA
AD8691AKSZ-REEL	-40°C to +125°C	5-Lead SC70	KS-5	ACA
AD8691AKSZ-REEL7	-40°C to +125°C	5-Lead SC70	KS-5	ACA
AD8691WAUJZ-R7	-40°C to +125°C	5-Lead TSOT	UJ-5	ACA
AD8691WAUJZ-RL	-40°C to +125°C	5-Lead TSOT	UJ-5	ACA
AD8692ARMZ-R7	-40°C to +125°C	8-Lead MSOP	RM-8	APA
AD8692ARMZ-REEL	-40°C to +125°C	8-Lead MSOP	RM-8	APA
AD8692ARZ	-40°C to +125°C	8-Lead SOIC_N	R-8	
AD8692ARZ-REEL	-40°C to +125°C	8-Lead SOIC_N	R-8	
AD8692ARZ-REEL7	-40°C to +125°C	8-Lead SOIC_N	R-8	
AD8692WARMZ-REEL	-40°C to +125°C	8-Lead MSOP	RM-8	APA
AD8694ARUZ	-40°C to +125°C	14-Lead TSSOP	RU-14	
AD8694ARUZ-REEL	-40°C to +125°C	14-Lead TSSOP	RU-14	
AD8694WARUZ	-40°C to +125°C	14-Lead TSSOP	RU-14	
AD8694WARUZ-REEL	-40°C to +125°C	14-Lead TSSOP	RU-14	
AD8694ARZ	-40°C to +125°C	14-Lead SOIC_N	R-14	
AD8694ARZ-REEL	-40°C to +125°C	14-Lead SOIC_N	R-14	
AD8694ARZ-REEL7	-40°C to +125°C	14-Lead SOIC_N	R-14	
AD8694WAC-P3	-40°C to +125°C	Die		
AD8694WAC-P7	-40°C to +125°C	Die		

¹ Z = RoHS Compliant Part.² W = Qualified for Automotive Applications.**AUTOMOTIVE PRODUCTS**

The [AD8691W](#)/[AD8692W](#)/[AD8694W](#) models are available with controlled manufacturing to support the quality and reliability requirements of automotive applications. Note that these automotive models may have specifications that differ from the commercial models; therefore, designers should review the Specifications section of this data sheet carefully. Only the automotive grade products shown are available for use in automotive applications. Contact your local Analog Devices account representative for specific product ordering information and to obtain the specific Automotive Reliability reports for these models.

NOTES

AD8691/AD8692/AD8694

NOTES

OUR CERTIFICATE

DiGi provide top-quality products and perfect service for customer worldwide through standardization, technological innovation and continuous improvement. DiGi through third-party certification, we stricly control the quality of products and services. Welcome your RFQ to

Email: Info@DiGi-Electronics.com



Tel: +00 852-30501935

RFQ Email: Info@DiGi-Electronics.com

DiGi is a global authorized distributor of electronic components.