

# AD9671KBCZ Datasheet

[www.digi-electronics.com](http://www.digi-electronics.com)

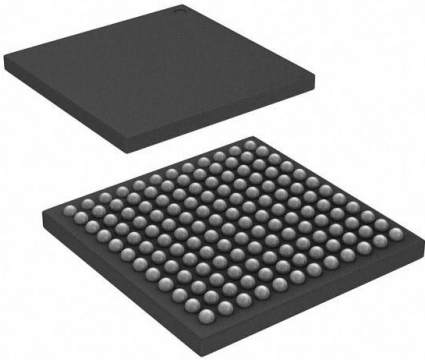

<https://www.DiGi-Electronics.com>

DiGi Electronics Part Number	AD9671KBCZ-DG
Manufacturer	<a href="#">Analog Devices Inc.</a>
Manufacturer Product Number	AD9671KBCZ
Description	IC AFE 8 CHAN 14BIT 144CSPBGA
Detailed Description	8 Channel AFE 14 Bit 150 mW 144-CSPBGA (10x10)

This model AD9671KBCZ is available at DiGi Electronics.

DiGi Electronics offers a global database of semiconductor and electronic component datasheets.

We welcome your inquiries regarding pricing, lead time, or other product-related questions.

 [Request a Quote](#)

 [Datasheet Search](#)



Tel: +00 852-30501935

RFQ Email: [Info@DiGi-Electronics.com](mailto:Info@DiGi-Electronics.com)

DiGi is a global authorized distributor of electronic components.

## Purchase and inquiry

Manufacturer Product Number:

AD9671KBCZ

Series:

-

Number of Bits:

14

Power (Watts):

150 mW

Voltage - Supply, Digital:

-

Package / Case:

144-LFBGA, CSPBGA

Base Product Number:

AD9671

Manufacturer:

Analog Devices Inc.

Product Status:

Active

Number of Channels:

8

Voltage - Supply, Analog:

-

Mounting Type:

Surface Mount

Supplier Device Package:

144-CSPBGA (10x10)

## Environmental & Export classification

RoHS Status:

ROHS3 Compliant

REACH Status:

REACH Unaffected

HTSUS:

8542.39.0001

Moisture Sensitivity Level (MSL):

3 (168 Hours)

ECCN:

EAR99



# JESD204B Octal Ultrasound AFE with Digital Demodulator

Data Sheet

AD9671

## FEATURES

8 channels of LNA, VGA, AAF, ADC, and digital demodulator/decimator

Low power: 150 mW per channel, time gain compensation (TGC) mode, 40 MSPS

62.5 mW per channel, continuous wave (CW) mode; <30 mW in power-down mode

10 mm × 10 mm, 144-ball CSP\_BGA

TGC channel input referred noise: 0.82 nV/√Hz, maximum gain

Flexible power-down modes

Fast recovery from low power standby mode: <2 μs

Low noise preamplifier (LNA)

Input referred noise: 0.78 nV/√Hz, gain = 21.6 dB

Programmable gain: 15.6 dB/17.9 dB/21.6 dB

0.1 dB compression: 1000 mV p-p/750 mV p-p/450 mV p-p

Flexible active input impedance matching

Variable gain amplifier (VGA)

Attenuator range: 45 dB, linear-in-dB gain control

Postamplifier (PGA) gain: 21 dB/24 dB/27 dB/30 dB

Antialiasing filter (AAF)

Programmable, second-order low-pass filter (LPF) from 8 MHz to 18 MHz or 13.5 MHz to 30 MHz and high-pass filter (HPF)

Analog-to-digital converter (ADC)

Signal-to-noise ratio (SNR): 75 dB, 14 bits up to 125 MSPS

JESD204B Subclass 0 coded serial digital outputs

CW Doppler (CWD) mode harmonic rejection I/Q demodulator

Individual programmable phase rotation

Dynamic range per channel: 160 dBFS/√Hz

Close-in SNR: 156 dBc/√Hz, 1 kHz offset, -3 dBFS input

Digital demodulator/decimator

I/Q demodulator with programmable oscillator

## APPLICATIONS

Medical imaging/ultrasound

Nondestructive testing (NDT)

## GENERAL DESCRIPTION

The AD9671 is designed for low cost, low power, small size, and ease of use for medical ultrasound applications. It contains eight channels of a VGA with an LNA, a CW harmonic rejection I/Q demodulator with programmable phase rotation, an AAF, an ADC, and a digital demodulator and decimator for data processing and bandwidth reduction.

Each channel features a maximum gain of up to 52 dB, a fully differential signal path, and an active input preamplifier termination. The channel is optimized for high dynamic performance and low power in applications where a small package size is critical.

The LNA has a single-ended to differential gain that is selectable through the serial port interface (SPI). Assuming a 15 MHz noise bandwidth (NBW) and a 21.6 dB LNA gain, the LNA input SNR is 94 dB. In CW Doppler mode, each LNA output drives an I/Q demodulator that has independently programmable phase rotation with 16 phase settings.

Power-down of individual channels is supported to increase battery life for portable applications. Standby mode allows quick power-up for power cycling. In CW Doppler operation, the VGA, AAF, and ADC are powered down. The ADC contains several features designed to maximize flexibility and minimize system cost, such as a programmable clock, data alignment, and programmable digital test pattern generation. The digital test patterns include built-in fixed patterns, built-in pseudorandom patterns, and custom user defined test patterns entered via the SPI.

Rev. A

[Document Feedback](#)

Information furnished by Analog Devices is believed to be accurate and reliable. However, no responsibility is assumed by Analog Devices for its use, nor for any infringements of patents or other rights of third parties that may result from its use. Specifications subject to change without notice. No license is granted by implication or otherwise under any patent or patent rights of Analog Devices. Trademarks and registered trademarks are the property of their respective owners.

One Technology Way, P.O. Box 9106, Norwood, MA 02062-9106, U.S.A.  
Tel: 781.329.4700 ©2013–2016 Analog Devices, Inc. All rights reserved.  
[Technical Support](#) [www.analog.com](http://www.analog.com)

**TABLE OF CONTENTS**

Features .....	1	CW Doppler Operation.....	39
Applications.....	1	Digital Demodulator/Decimator.....	40
General Description .....	1	Vector Profile .....	40
Revision History .....	2	RF Decimator.....	41
Functional Block Diagram .....	3	Baseband Demodulator and Decimator.....	42
Specifications.....	4	Digital Test Waveforms.....	43
AC Specifications.....	4	Digital Block Power Saving Scheme .....	43
Digital Specifications .....	8	Serial Port Interface (SPI).....	44
Switching Specifications .....	9	Hardware Interface.....	44
Absolute Maximum Ratings.....	12	Memory Map .....	46
Thermal Impedance.....	12	Reading the Memory Map Table.....	46
ESD Caution.....	12	Reserved Locations .....	46
Pin Configuration and Function Descriptions.....	13	Default Values .....	46
Typical Performance Characteristics .....	16	Logic Levels.....	46
TGC Mode.....	16	Recommended Start-Up Sequence .....	46
CW Doppler Mode.....	20	Memory Map Register Descriptions.....	59
Theory of Operation .....	21	Outline Dimensions .....	60
TGC Operation.....	21	Ordering Guide .....	60
Digital Outputs and Timing.....	29		
Analog Test Tone Generation .....	38		

**REVISION HISTORY**

1/16—Revision A: Initial Version

# FUNCTIONAL BLOCK DIAGRAM

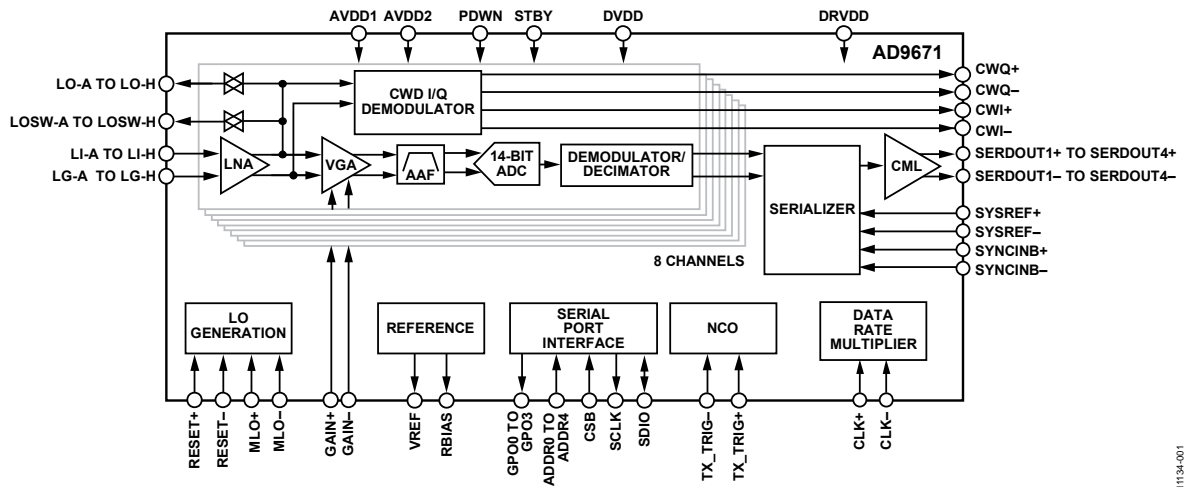

Figure 1.

11134-001

## SPECIFICATIONS

### AC SPECIFICATIONS

AVDD1 = 1.8 V, AVDD2 = 3.0 V, DVDD = 1.4 V, DRVDD = 1.8 V, 1.0 V internal ADC reference, full temperature range (0°C to 85°C),  $f_{IN} = 5$  MHz, low bandwidth mode,  $R_S = 50 \Omega$ ,  $R_{FB} = \infty$  (unterminated), LNA gain = 21.6 dB, LNA bias = midhigh, PGA gain = 27 dB, analog gain control,  $V_{GAIN} (V) = (GAIN+) - (GAIN-) = 1.6$  V, AAF LPF cutoff =  $f_{SAMPLE}/3$  (Mode I/Mode II) =  $f_{SAMPLE}/4.5$  (Mode III/Mode IV), HPF cutoff = LPF cutoff/12.00, Mode I =  $f_{SAMPLE} = 40$  MSPS, Mode II =  $f_{SAMPLE} = 65$  MSPS, Mode III =  $f_{SAMPLE} = 80$  MSPS, Mode IV = 125 MSPS, RF decimator bypassed (Mode I/Mode II), RF decimator enabled (Mode III/Mode IV), digital high-pass filter bypassed, demodulator bypassed, baseband decimator bypassed, JESD204B link parameters: M = 8 and L = 2, unless otherwise noted. All gain setting options are listed, which can be configured via SPI registers, and all power supply currents and power dissipations are listed for the four mode settings (Mode I, Mode II, Mode III, and Mode IV), respectively, via slashes in Table 1.

Table 1.

Parameter <sup>1</sup>	Test Conditions/Comments	Min	Typ	Max	Unit
<b>LNA CHARACTERISTICS</b>					
Gain	Single-ended input to differential output		15.6/17.9/21.6		dB
	Single-ended input to single-ended output		9.6/11.9/15.6		dB
0.1 dB Input Compression Point	LNA gain = 15.6 dB		1000		mV p-p
	LNA gain = 17.9 dB		750		mV p-p
	LNA gain = 21.6 dB		450		mV p-p
1 dB Input Compression Point	LNA gain = 15.6 dB		1200		mV p-p
	LNA gain = 17.9 dB		900		mV p-p
	LNA gain = 21.6 dB		600		mV p-p
Input Common Mode (LI-x, LG-x)			2.2		V
Output Common Mode					
LO-x	Switch off		High-Z		$\Omega$
	Switch on		1.5		V
LOSW-x	Switch off		High-Z		$\Omega$
	Switch on		1.5		V
Input Resistance (LI-x)	$R_{FB} = 300 \Omega$ , LNA gain = 21.6 dB		50		$\Omega$
	$R_{FB} = 1350 \Omega$ , LNA gain = 21.6 dB		200		$\Omega$
			6		k $\Omega$
Input Capacitance (LI-x)			22		pF
Input Referred Noise Voltage	$R_S = 0 \Omega$				
	LNA gain = 15.6 dB		0.83		nV/ $\sqrt{\text{Hz}}$
	LNA gain = 17.9 dB		0.82		nV/ $\sqrt{\text{Hz}}$
	LNA gain = 21.6 dB		0.78		nV/ $\sqrt{\text{Hz}}$
Input Signal-to-Noise Ratio	Noise bandwidth = 15 MHz		94		dB
Input Noise Current			2.6		pA/ $\sqrt{\text{Hz}}$
<b>FULL CHANNEL CHARACTERISTICS</b>					
AAF Low-Pass Cutoff	Time gain control (TGC)				
	-3 dB, programmable, low bandwidth mode	8		18	MHz
	-3 dB, programmable, high bandwidth mode	13.5		30	MHz
In Range AAF Bandwidth Tolerance			$\pm 10$		%
Group Delay Variation	$f = 1$ MHz to 18 MHz, $V_{GAIN} = -1.6$ V to +1.6 V		$\pm 350$		ps
Input Referred Noise Voltage	LNA gain = 15.6 dB		0.96		nV/ $\sqrt{\text{Hz}}$
	LNA gain = 17.9 dB		0.90		nV/ $\sqrt{\text{Hz}}$
	LNA gain = 21.6 dB		0.82		nV/ $\sqrt{\text{Hz}}$

## Data Sheet

AD9671

Parameter <sup>1</sup>	Test Conditions/Comments	Min	Typ	Max	Unit
Noise Figure					
Active Termination Matched	LNA gain = 15.6 dB, R <sub>FB</sub> = 150 Ω		5.6		dB
	LNA gain = 17.9 dB, R <sub>FB</sub> = 200 Ω		4.8		dB
	LNA gain = 21.6 dB, R <sub>FB</sub> = 300 Ω		3.8		dB
Unterminated	LNA gain = 15.6 dB, R <sub>FB</sub> = ∞		3.2		dB
	LNA gain = 17.9 dB, R <sub>FB</sub> = ∞		2.9		dB
	LNA gain = 21.6 dB, R <sub>FB</sub> = ∞		2.6		dB
Correlated Noise Ratio	No signal, correlated/uncorrelated		-30		dB
Output Offset		-125		+125	LSB
Signal-to-Noise Ratio (SNR)	f <sub>IN</sub> = 5 MHz at -12 dBFS, V <sub>GAIN</sub> = -1.6 V		69		dBFS
	f <sub>IN</sub> = 5 MHz at -1 dBFS, V <sub>GAIN</sub> = 1.6 V		59		dBFS
Close-In SNR	f <sub>IN</sub> = 3.5 MHz at -0.5 dBFS, V <sub>GAIN</sub> = 0 V, 1 kHz offset		-130		dBc/√Hz
Second Harmonic	f <sub>IN</sub> = 5 MHz at -12 dBFS, V <sub>GAIN</sub> = -1.6 V		-70		dBc
	f <sub>IN</sub> = 5 MHz at -1 dBFS, V <sub>GAIN</sub> = 1.6 V		-62		dBc
Third Harmonic	f <sub>IN</sub> = 5 MHz at -12 dBFS, V <sub>GAIN</sub> = -1.6 V		-61		dBc
	f <sub>IN</sub> = 5 MHz at -1 dBFS, V <sub>GAIN</sub> = 1.6 V		-55		dBc
Two-Tone Intermodulation Distortion (IMD3)	f <sub>RF1</sub> = 5.015 MHz, f <sub>RF2</sub> = 5.020 MHz, A <sub>RF1</sub> = -1 dBFS, A <sub>RF2</sub> = -21 dBFS, V <sub>GAIN</sub> = 1.6 V, IMD3 relative to A <sub>RF2</sub>		-54		dBc
Channel-to-Channel Crosstalk	f <sub>IN1</sub> = 5.0 MHz at -1 dBFS		-60		dB
	Overrange condition <sup>2</sup>		-55		dB
<b>GAIN ACCURACY</b>	T <sub>A</sub> = 25°C				
Gain Law Conformance Error	-1.6 < V <sub>GAIN</sub> < -1.28 V		0.4		dB
	-1.28 V < V <sub>GAIN</sub> < +1.28 V	-1.3		+1.3	dB
	1.28 V < V <sub>GAIN</sub> < 1.6 V		-0.5		dB
	V <sub>GAIN</sub> = 0 V, normalized for ideal AAF loss	-0.9		+0.9	dB
Channel-to-Channel Matching	-1.28 V < V <sub>GAIN</sub> < +1.28 V, 1 σ		0.1		dB
PGA Gain			21/24/27/30		dB
<b>GAIN CONTROL INTERFACE</b>					
Control Range	Differential	-1.6		+1.6	V
Control Common Mode	GAIN+, GAIN-	0.7	0.8	0.9	V
Input Impedance	GAIN+, GAIN-		10		MΩ
Gain Range			45		dB
Gain Sensitivity	Analog		14		dB/V
	Digital step size		3.5		dB
Response Time	Analog 45 dB change		750		ns
<b>CW DOPPLER MODE</b>					
LO Frequency	f <sub>LO</sub> = f <sub>MLO</sub> /M	1		10	MHz
Phase Resolution	Per channel, 4LO <sup>3</sup> mode		45		Degrees
	Per channel, 8LO <sup>3</sup> mode, 16LO <sup>3</sup> mode		22.5		Degrees
Output DC Bias (Single-Ended)	CWI+, CWI-, CWQ+, CWQ-		AVDD2/2		V
Output AC Current Range	Per CWI+, CWI-, CWQ+, CWQ-, each channel enabled (2 f <sub>LO</sub> and baseband signal)		±2.2	±2.5	mA
Transconductance (Differential)	Demodulated I <sub>OUT</sub> /V <sub>IN</sub> , per CWI+, CWI-, CWQ+, CWQ-				
	LNA gain = 15.6 dB		3.3		mA/V
	LNA gain = 17.9 dB		4.3		mA/V
	LNA gain = 21.6 dB		6.6		mA/V
Input Referred Noise Voltage	R <sub>S</sub> = 0 Ω, R <sub>FB</sub> = ∞				
	LNA gain = 15.6 dB		1.6		nV/√Hz
	LNA gain = 17.9 dB		1.3		nV/√Hz
	LNA gain = 21.6 dB		1.0		nV/√Hz

## AD9671

## Data Sheet

Parameter <sup>1</sup>	Test Conditions/Comments	Min	Typ	Max	Unit
Noise Figure	$R_S = 50 \Omega$ , $R_{FB} = \infty$		5.7		dB
	LNA gain = 15.6 dB		4.5		dB
	LNA gain = 21.6 dB		3.4		dB
Input Referred Dynamic Range	$R_S = 0 \Omega$ , $R_{FB} = \infty$		164		dBFS/√Hz
	LNA gain = 15.6 dB		162		dBFS/√Hz
	LNA gain = 21.6 dB		160		dBFS/√Hz
Close-In SNR	-3 dBFS input, $f_{RF} = 2.5$ MHz, $f_{LO} = 40$ MHz, 1 kHz offset, 16LO mode, one channel enabled		156		dBc/√Hz
	-3 dBFS input, $f_{RF} = 2.5$ MHz, $f_{LO} = 40$ MHz, 1 kHz offset, 16LO mode, eight channels enabled		161		dBc/√Hz
Two-Tone Intermodulation Distortion (IMD3)	$f_{RF1} = 5.015$ MHz, $f_{RF2} = 5.020$ MHz, $f_{LO} = 80$ MHz, $A_{RF1} = -1$ dBFS, $A_{RF2} = -21$ dBFS, IMD3 relative to $A_{RF2}$		-58		dBc
LO Harmonic Rejection				-20	dBc
Quadrature Phase Error	I to Q, all phases, 1 $\sigma$		0.15		Degrees
I/Q Amplitude Imbalance	I to Q, all phases, 1 $\sigma$		0.015		dB
Channel to Channel Matching	Phase I to I, Q to Q, 1 $\sigma$		0.5		Degrees
	Amplitude I to I, Q to Q, 1 $\sigma$		0.25		dB
POWER SUPPLY	Mode I/Mode II/Mode III/Mode IV				
AVDD1		1.7	1.8	1.9	V
AVDD2		2.85	3.0	3.6	V
DVDD	Demodulator/decimator enabled	1.3	1.4	1.9	V
DRVDD		1.7	1.8	1.9	V
$I_{AVDD1}$	TGC mode, low bandwidth mode		148/187/223/291		mA
	CW Doppler mode		4		mA
$I_{AVDD2}$	TGC mode, no signal, low bandwidth mode		230		mA
	TGC mode, no signal, high bandwidth mode		239		mA
	CW Doppler mode		140		mA
$I_{DVDD}$	Demodulator/decimator enabled		156/247/166/255		mA
	Demodulator/decimator disabled		29/46/40/61		mA
$I_{DRVDD}$	Four-lane mode, JESD204B lane rates = 1.6 Gbps/2.6 Gbps/1.6 Gbps/2.5 Gbps		121/168/122/166		mA
	Two-lane mode, JESD204B lane rates = 3.2 Gbps/5.0 Gbps/3.2 Gbps/5.0 Gbps		127/186/129/184		mA
	One-lane mode, demodulator/decimator enabled, JESD204B lane rates = 3.2 Gbps/5.0 Gbps/3.2 Gbps/5.0 Gbps <sup>4</sup>		73/105/76/105		mA
Total Power Dissipation (Including Output Drivers)	TGC mode, no signal, two-lane mode, demodulator/decimator disabled		1200/1415/1365/1615	1445/1680/1635/1910	mW
	TGC mode, no signal, two-lane mode, demodulator/decimator enabled		1390/1710/1550/1895	1645/2025/1835/2215	mW
	CW Doppler mode, eight channels enabled		500		mW
Power-Down Dissipation			5	30	mW
Standby Power Dissipation			725		mW

## Data Sheet

AD9671

Parameter <sup>1</sup>	Test Conditions/Comments	Min	Typ	Max	Unit
ADC					
Resolution			14		Bits
SNR			75		dB
ADC REFERENCE					
Output Voltage Error	VREF = 1 V			±50	mV
Load Regulation at 1.0 mA	VREF = 1 V		2		mV
Input Resistance			7.5		kΩ

<sup>1</sup> See the [AN-835 Application Note](#), *Understanding High Speed ADC Testing and Evaluation*, for a complete set of definitions and information about how these tests were completed.

<sup>2</sup> The overrange condition is specified as 6 dB more than the full-scale input range.

<sup>3</sup> The internal LO frequency,  $f_{LO}$ , is generated from the supplied multiplier local oscillator frequency,  $f_{MLO}$ , by dividing it up by a configurable divider value (M) that can be 4, 8, or 16; the MLO signal is named 4LO, 8LO, or 16LO, accordingly.

<sup>4</sup> Baseband decimation rate = 4. M = 16.

## AD9671

## Data Sheet

## DIGITAL SPECIFICATIONS

AVDD1 = 1.8 V, AVDD2 = 3.0 V, DVDD = 1.4 V, DRVDD = 1.8 V, 1.0 V internal ADC reference, full temperature range (0°C to 85°C), unless otherwise noted.

Table 2.

Parameter <sup>1</sup>	Temperature	Min	Typ	Max	Unit
<b>INPUTS</b>					
CLK+, CLK-, TX_TRIG+, TX_TRIG-					
Logic Compliance			CMOS/LVDS/LVPECL		
Differential Input Voltage <sup>2</sup>		0.2		3.6	V p-p
Input Voltage Range		GND - 0.2		AVDD1 + 0.2	V
Input Common-Mode Voltage			0.9		V
Input Resistance (Differential)	25°C		15		kΩ
Input Capacitance	25°C		4		pF
MLO+, MLO-, RESET+, RESET-					
Logic Compliance			LVDS/LVPECL		
Differential Input Voltage <sup>2</sup>		0.250		AVDD2 × 2	V p-p
Input Voltage Range		GND - 0.2		AVDD2 + 0.2	V
Input Common-Mode Voltage			AVDD2/2		V
Input Resistance (Single-Ended)	25°C		20		kΩ
Input Capacitance	25°C		1.5		pF
<b>LOGIC INPUTS</b>					
PDWN, STBY, SCLK, SDIO, ADDR <sub>x</sub>					
Logic 1 Voltage	Full	1.2		DRVDD + 0.3	V
Logic 0 Voltage	Full			0.3	V
Input Resistance	25°C		30 (SDIO = 26)		kΩ
Input Capacitance	25°C		2 (SDIO = 5)		pF
CSB					
Logic 1 Voltage	Full	1.2		DRVDD + 0.3	V
Logic 0 Voltage	Full			0.3	V
Input Resistance	25°C		26		kΩ
Input Capacitance	25°C		2		pF
<b>LOGIC OUTPUTS</b>					
SDIO <sup>3</sup>					
Logic 1 Voltage (I <sub>OH</sub> = 800 μA)	Full		1.79		V
Logic 0 Voltage (I <sub>OL</sub> = 50 μA)	Full			0.05	V
GPO0, GPO1, GPO2, GPO3					
Logic 0 Voltage (I <sub>OL</sub> = 50 μA)	Full			0.05	V
<b>DIGITAL OUTPUTS (SERDOUT<sub>x+</sub>, SERDOUT<sub>x-</sub>)</b>					
Logic Compliance			CML		
Differential Output Voltage (V <sub>OD</sub> )	Full	400	600	750	mV
Output Offset Voltage (V <sub>OS</sub> )	Full	0.75		1.05	V
<b>DIGITAL INPUTS</b>					
SYNCINB+, SYNCINB-					
Logic Compliance			LVDS		
Internal Bias	Full		0.9		V
Differential Input Voltage Range	Full	0.3		3.6	V
Input Voltage Range	Full	GND		DRVDD	V
Input Common-Mode Range	Full	0.9		1.4	V
High Level Input Current	Full	-5		+5	μA
Low Level Input Current	Full	-5		+5	μA
Input Capacitance	Full		1		pF
Input Resistance	Full	12	16	20	kΩ

## Data Sheet

AD9671

Parameter <sup>1</sup>	Temperature	Min	Typ	Max	Unit
SYSREF+, SYSREF– Logic Compliance			LVDS		
Internal Common-Mode Bias	Full		0.9		V
Differential Input Voltage	Full	0.3		3.6	V p-p
Input Voltage Range	Full	GND		DRVDD	V
Input Common-Mode Range	Full	0.9		1.4	V
High Level Input Current	Full	–5		+5	μA
Low Level Input Current	Full	–5		+5	μA
Input Capacitance	Full		4		pF
Input Resistance	Full	8	10	12	kΩ

<sup>1</sup> See the [AN-835 Application Note](#), *Understanding High Speed ADC Testing and Evaluation*, for a complete set of definitions and information about how these tests were completed.

<sup>2</sup> Specified for LVDS and LVPECL only.

<sup>3</sup> Specified for 13 SDIO pins sharing the same connection.

### SWITCHING SPECIFICATIONS

AVDD1 = 1.8 V, AVDD2 = 3.0 V, DVDD = 1.4 V, DRVDD = 1.8 V, 1.0 V internal ADC reference, L = 2, M = 8,  $f_{\text{SAMPLE}} = 40$  MHz, lane data rate = 3.2 Gbps, full temperature range (0°C to 85°C), unless otherwise noted.

**Table 3.**

Parameter <sup>1</sup>	Temperature	Min	Typ	Max	Unit
CLOCK <sup>2</sup>					
Clock Rate ( $f_{\text{SAMPLE}}$ )					
40 MSPS (Mode I)	Full	20.5		40	MHz
65 MSPS (Mode II)	Full	20.5		65	MHz
80 MSPS (Mode III) <sup>3</sup>	Full	20.5		80	MHz
125 MSPS (Mode IV) <sup>4</sup>	Full	20.5		125	MHz
Clock Pulse Width High ( $t_{\text{EH}}$ )	Full		3.75		ns
Clock Pulse Width Low ( $t_{\text{EL}}$ )	Full		3.75		ns
CLOCK INPUT PARAMETERS					
TX_TRIG± to CLK± Setup Time ( $t_{\text{SETUP}}$ )	25°C	1			ns
TX_TRIG± to CLK± Hold Time ( $t_{\text{HOLD}}$ )	25°C	1			ns
DATA OUTPUT PARAMETERS					
Data Output Period or Unit Interval (UI)	Full		$L/(20 \times M \times f_{\text{SAMPLE}})$		sec
Data Output Duty Cycle	25°C		50		%
Data Valid Time	25°C		0.76		UI
PLL Lock Time <sup>5</sup>	25°C		26		μs
Wake-Up Time					
Standby	25°C		2		μs
Power-Down <sup>6</sup>					
Device	25°C		375		μs
JESD204B Link	25°C		250		μs
SYNCINB± Falling Edge to First K.28 Characters	Full	4			Multiframe
Code Group Synchronization (CGS) Phase K.28 Characters Duration	Full	1			Multiframe
Delay (Latency)	Full				
ADC Pipeline	Full		16		Cycles
RF Decimator	Full		11		Cycles
Digital High-Pass Filter	Full		100		Cycles
Baseband Decimator	Full		$16 \times \text{decimation factor}$		Cycles
TX_TRIG± to Start Code (Mode I/Mode II/Mode III/Mode IV)					
Four-Lane Mode	Full		31/42/30/36		Cycles
Two-Lane Mode	Full		31/33/30/30		Cycles

## AD9671

## Data Sheet

Parameter <sup>1</sup>	Temperature	Min	Typ	Max	Unit
Data Rate per Lane	25°C			5.0	Gbps
Uncorrelated Bounded High Probability (UBHP) Jitter	25°C		11		ps
Random Jitter at 2.5 Gbps Data Rate	25°C		80		ps rms
Random Jitter at 5 Gbps Data Rate	25°C		46		ps rms
Output Rise/Fall Time	25°C		64		ps
<b>TERMINATION CHARACTERISTICS</b>					
Differential Termination Resistance	Full		100		Ω
<b>APERTURE</b>					
Aperture Uncertainty (Jitter)	25°C		<1		ps rms
<b>LO GENERATION</b>					
MLO± Frequency					
4LO Mode	Full	4		40	MHz
8LO Mode	Full	8		80	MHz
16LO Mode	Full	16		160	MHz
RESET± to MLO± Setup Time ( $t_{\text{SETUP}}$ )	Full	1	$t_{\text{MLO}}^7/2$		ns
RESET± to MLO± Hold Time ( $t_{\text{HOLD}}$ )	Full	1	$t_{\text{MLO}}^7/2$		ns

<sup>1</sup> See the [AN-835 Application Note](#), *Understanding High Speed ADC Testing and Evaluation*, for a complete set of definitions and information about how these tests were completed.

<sup>2</sup> Can be adjusted via the SPI.

<sup>3</sup> Mode III must have the RF decimator enabled.

<sup>4</sup> Mode IV must have the RF decimator enabled.

<sup>5</sup> PLL lock time from 0 Hz to 40 MHz frequency change.

<sup>6</sup> Wake-up time is defined as the time required to return to normal operation from power-down mode.

<sup>7</sup> The period of the MLO clock signal is represented by  $t_{\text{MLO}}$ .

### CLK±, TX\_TRIG± Synchronization Timing Diagram

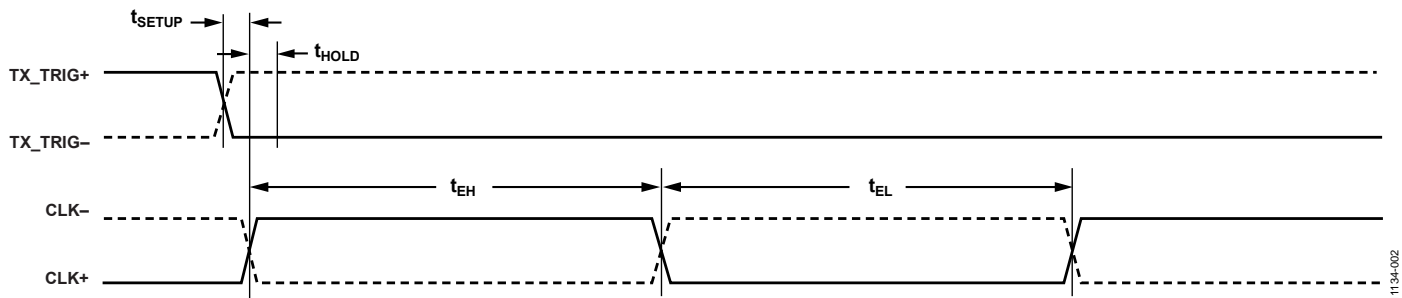

Figure 2. TX\_TRIG± to CLK± Input Timing

### CW Timing Diagram

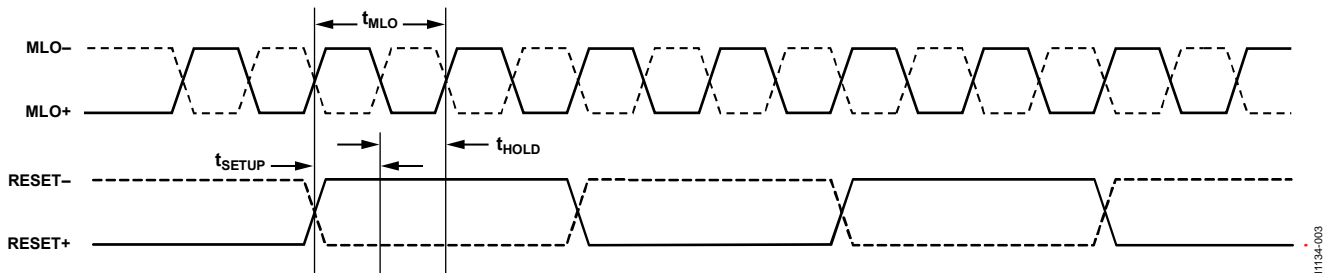

Figure 3. CW Doppler Mode Input MLO±, Continuous Synchronous RESET± Timing, Sampled on the Falling MLO± Edge, 4LO Mode

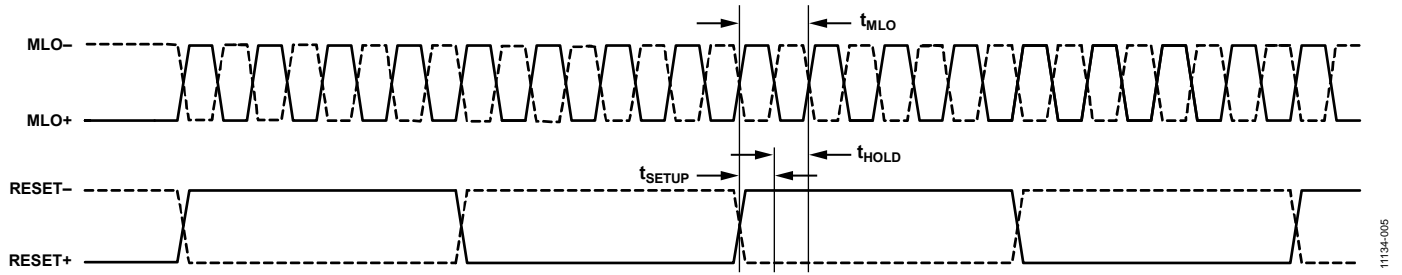

Figure 4. CW Doppler Mode Input MLO±, Continuous Synchronous RESET± Timing, Sampled on the Falling MLO± Edge, 8LO Mode

11134-005

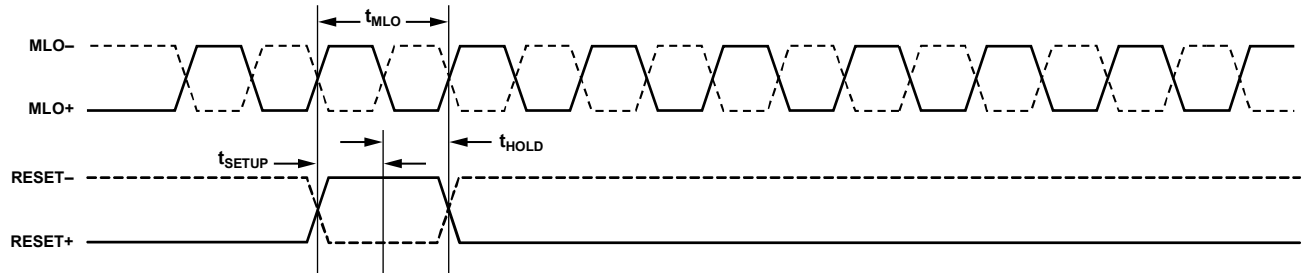

Figure 5. CW Doppler Mode Input MLO±, Pulse Synchronous RESET± Timing, 4LO/8LO/16LO Mode

11134-004

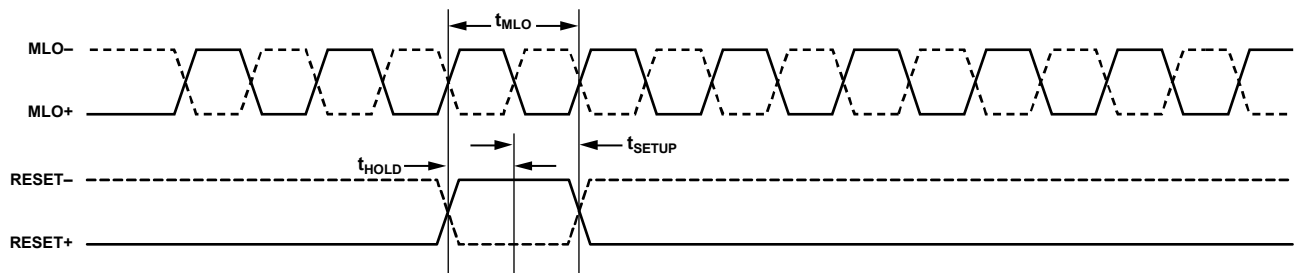

Figure 6. CW Doppler Mode Input MLO±, Pulse Asynchronous RESET± Timing, 4LO/8LO/16LO Mode

11134-006

## ABSOLUTE MAXIMUM RATINGS

Table 4.

Parameter	Rating
AVDD1 to GND	−0.3 V to +2.0 V
AVDD2 to GND	−0.3 V to +3.9 V
DVDD to GND	−0.3 V to +2.0 V
DRVDD to GND	−0.3 V to +2.0 V
GND to GND	−0.3 V to +0.3 V
AVDD2 to AVDD1	−2.0 V to +3.9 V
AVDD1 to DRVDD	−2.0 V to +2.0 V
AVDD2 to DRVDD	−2.0 V to +3.9 V
SERDOUTx+, SERDOUTx−, SDIO, PDWN, STBY, SCLK, CSB, ADDR <sub>x</sub> to GND	−0.3 V to DRVDD + 0.3 V
LI-x, LO-x, LOSW-x, CWI−, CWI+, CWQ−, CWQ+, GAIN+, GAIN−, RESET+, RESET−, MLO+, MLO−, GPO0, GPO1, GPO2, GPO3 to GND	−0.3 V to AVDD2 + 0.3 V
CLK+, CLK−, TX_TRIG+, TX_TRIG−, VREF to GND	−0.3 V to AVDD1 + 0.3 V
Operating Temperature Range (Ambient)	0°C to 85°C
Storage Temperature Range (Ambient)	−65°C to +150°C
Maximum Junction Temperature	150°C
Lead Temperature (Soldering, 10 sec)	300°C

Stresses at or above those listed under Absolute Maximum Ratings may cause permanent damage to the product. This is a stress rating only; functional operation of the product at these or any other conditions above those indicated in the operational section of this specification is not implied. Operation beyond the maximum operating conditions for extended periods may affect product reliability.

## THERMAL IMPEDANCE

Table 5. Thermal Impedance

Symbol	Description	Value <sup>1</sup>	Unit
$\theta_{JA}$	Junction to ambient thermal resistance, 0.0 m/sec air flow per JEDEC JESD51-2 (still air)	22.0	°C/W
$\Psi_{JB}$	Junction to board thermal characterization parameter, 0 m/sec air flow per JEDEC JESD51-8 (still air)	9.2	°C/W
$\Psi_{JT}$	Junction to top of package characterization parameter, 0 m/sec air flow per JEDEC JESD51-2 (still air)	0.12	°C/W

<sup>1</sup> Results are from simulations. Printed circuit board (PCB) is JEDEC multilayer. Thermal performance for actual applications requires careful inspection of the conditions in the application to determine if they are similar to those assumed in these calculations.

## ESD CAUTION



**ESD (electrostatic discharge) sensitive device.** Charged devices and circuit boards can discharge without detection. Although this product features patented or proprietary protection circuitry, damage may occur on devices subjected to high energy ESD. Therefore, proper ESD precautions should be taken to avoid performance degradation or loss of functionality.

# PIN CONFIGURATION AND FUNCTION DESCRIPTIONS

	1	2	3	4	5	6	7	8	9	10	11	12
A	LI-E	LI-F	LI-G	LI-H	VREF	RBIAS	GAIN+	GAIN-	LI-A	LI-B	LI-C	LI-D
B	LG-E	LG-F	LG-G	LG-H	GND	GND	CLNA	GND	LG-A	LG-B	LG-C	LG-D
C	LO-E	LO-F	LO-G	LO-H	GND	GND	GND	GND	LO-A	LO-B	LO-C	LO-D
D	LOSW-E	LOSW-F	LOSW-G	LOSW-H	GND	GND	GND	GND	LOSW-A	LOSW-B	LOSW-C	LOSW-D
E	GND	AVDD2	AVDD2	AVDD2	GND	GND	GND	GND	AVDD2	AVDD2	AVDD2	GND
F	AVDD1	GND	AVDD1	GND	AVDD1	GND	GND	AVDD1	GND	AVDD1	GND	AVDD1
G	GND	AVDD1	GND	DVDD	GND	GND	GND	GND	AVDD1	GND	DVDD	GND
H	CLK-	TX_TRIG-	GND	GND	GND	GND	ADDR4	ADDR3	ADDR2	ADDR1	ADDR0	CSB
J	CLK+	TX_TRIG+	CWQ+	GND	CWI+	AVDD2	MLO+	RESET-	GPO3	GPO1	PDWN	SDIO
K	GND	GND	CWQ-	GND	CWI-	AVDD2	MLO-	RESET+	GPO2	GPO0	STBY	SCLK
L	DRVDD	NIC	NIC	SYNCINB+	SERDOUT4+	SERDOUT3+	SERDOUT2+	SERDOUT1+	SYSREF+	NIC	NIC	DRVDD
M	GND	NIC	NIC	SYNCINB-	SERDOUT4-	SERDOUT3-	SERDOUT2-	SERDOUT1-	SYSREF-	NIC	NIC	GND

NIC = NOT INTERNALLY CONNECTED.

Figure 7. Pin Configuration

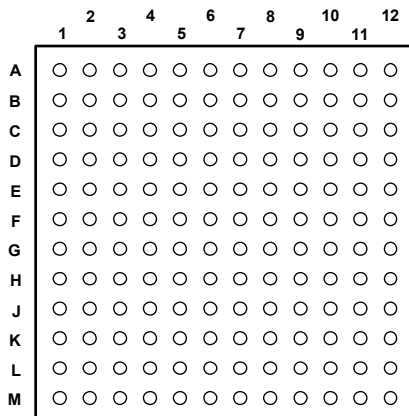

TOP VIEW  
(Not to Scale)

Figure 8. CSP\_BGA Pin Location

**AD9671****Data Sheet****Table 6. Pin Function Descriptions**

Pin No.	Mnemonic	Description
B5, B6, B8, C5 to C8, D5 to D8, E1, E5 to E8, E12, F2, F4, F6, F7, F9, F11, G1, G3, G5 to G8, G10, G12, H3 to H6, J4, K1, K2, K4, M1, M12	GND	Ground. These pins are tied to a quiet analog ground.
F1, F3, F5, F8, F10, F12, G2, G9	AVDD1	1.8 V Analog Supply.
G4, G11	DVDD	1.4 V Digital Supply.
E2, E3, E4, E9, E10, E11, J6, K6	AVDD2	3.0 V Analog Supply.
B7	CLNA	LNA External Capacitor.
L1, L12	DRVDD	1.8 V Digital Output Driver Supply.
C1	LO-E	LNA Analog Inverted Output for Channel E.
D1	LOSW-E	LNA Analog Switched Output for Channel E.
A1	LI-E	LNA Analog Input for Channel E.
B1	LG-E	LNA Ground for Channel E.
C2	LO-F	LNA Analog Inverted Output for Channel F.
D2	LOSW-F	LNA Analog Switched Output for Channel F.
A2	LI-F	LNA Analog Input for Channel F.
B2	LG-F	LNA Ground for Channel F.
C3	LO-G	LNA Analog Inverted Output for Channel G.
D3	LOSW-G	LNA Analog Switched Output for Channel G.
A3	LI-G	LNA Analog Input for Channel G.
B3	LG-G	LNA Ground for Channel G.
C4	LO-H	LNA Analog Inverted Output for Channel H.
D4	LOSW-H	LNA Analog Switched Output for Channel H.
A4	LI-H	LNA Analog Input for Channel H.
B4	LG-H	LNA Ground for Channel H.
H1	CLK-	Clock Input Complement.
J1	CLK+	Clock Input True.
H2	TX_TRIG-	Transmit Trigger Complement.
J2	TX_TRIG+	Transmit Trigger True.
H11	ADDR0	Chip Address Bit 0.
H10	ADDR1	Chip Address Bit 1.
H9	ADDR2	Chip Address Bit 2.
H8	ADDR3	Chip Address Bit 3.
H7	ADDR4	Chip Address Bit 4.
L2, M2, L3, M3, L10, M10, L11, M11	NIC	Not Internally Connected. These pins are not connected internally. Allow the NIC pins to float, or connect them to ground. Avoid routing high speed signals through these pins because noise coupling may result.
L4	SYNCINB+	Active Low JESD204B LVDS SYNC Input—True.
M4	SYNCINB-	Active Low JESD204B LVDS SYNC Input—Complement.
M5	SERDOUT4-	Serial Lane 4 CML Output Data—Complement.
L5	SERDOUT4+	Serial Lane 4 CML Output Data—True.
M6	SERDOUT3-	Serial Lane 3 CML Output Data—Complement.
L6	SERDOUT3+	Serial Lane 3 CML Output Data—True.
M7	SERDOUT2-	Serial Lane 2 CML Output Data—Complement.
L7	SERDOUT2+	Serial Lane 2 CML Output Data—True.
M8	SERDOUT1-	Serial Lane 1 CML Output Data—Complement.
L8	SERDOUT1+	Serial Lane 1 CML Output Data—True.
M9	SYSREF-	Active Low JESD204B LVDS System Reference (SYSREF) Input—Complement.
L9	SYSREF+	Active Low JESD204B LVDS SYSREF Input—True.
K11	STBY	Standby Power-Down.
J11	PDWN	Full Power-Down.
K12	SCLK	Serial Clock.
J12	SDIO	Serial Data Input/Output.
H12	CSB	Chip Select Bar.

## Data Sheet

AD9671

Pin No.	Mnemonic	Description
B9	LG-A	LNA Ground for Channel A.
A9	LI-A	LNA Analog Input for Channel A.
D9	LOSW-A	LNA Analog Switched Output for Channel A.
C9	LO-A	LNA Analog Inverted Output for Channel A.
B10	LG-B	LNA Ground for Channel B.
A10	LI-B	LNA Analog Input for Channel B.
D10	LOSW-B	LNA Analog Switched Output for Channel B.
C10	LO-B	LNA Analog Inverted Output for Channel B.
B11	LG-C	LNA Ground for Channel C.
A11	LI-C	LNA Analog Input for Channel C.
D11	LOSW-C	LNA Analog Switched Output for Channel C.
C11	LO-C	LNA Analog Inverted Output for Channel C.
B12	LG-D	LNA Ground for Channel D.
A12	LI-D	LNA Analog Input for Channel D.
D12	LOSW-D	LNA Analog Switched Output for Channel D.
C12	LO-D	LNA Analog Inverted Output for Channel D.
K10	GPO0	General-Purpose Open-Drain Output 0.
J10	GPO1	General-Purpose Open-Drain Output 1.
K9	GPO2	General-Purpose Open-Drain Output 2.
J9	GPO3	General-Purpose Open-Drain Output 3.
J8	RESET-	Synchronizing Input for LO Divide by M Counter Complement.
K8	RESET+	Synchronizing Input for LO Divide by M Counter True.
K7	MLO-	CW Doppler Multiple Local Oscillator Input Complement.
J7	MLO+	CW Doppler Multiple Local Oscillator Input True.
A8	GAIN-	Gain Control Voltage Input Complement.
A7	GAIN+	Gain Control Voltage Input True.
A6	RBIAS	External Resistor to Set the Internal ADC Core Bias Current.
A5	VREF	Voltage Reference Input/Output.
K5	CWI-	CW Doppler I Output Complement.
J5	CWI+	CW Doppler I Output True.
K3	CWQ-	CW Doppler Q Output Complement.
J3	CWQ+	CW Doppler Q Output True.

# TYPICAL PERFORMANCE CHARACTERISTICS

## TGC MODE

Mode I =  $f_{SAMPLE} = 40$  MSPS,  $f_{IN} = 5$  MHz, low bandwidth mode,  $R_S = 50 \Omega$ ,  $R_{FB} = \infty$  (unterminated), LNA gain = 21.6 dB, LNA bias = midhigh, PGA gain = 27 dB,  $V_{GAIN} (V) = (GAIN+) - (GAIN-) = 1.6$  V, AAF LPF cutoff =  $f_{SAMPLE}/3$ , HPF cutoff = LPF cutoff/12.00 (default), RF decimator bypassed, digital demodulator and baseband decimator bypassed, unless otherwise noted.

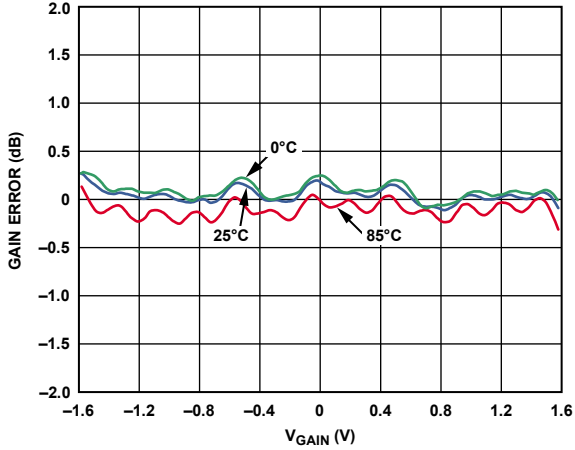

Figure 9. Gain Error vs.  $V_{GAIN}$

11134-009

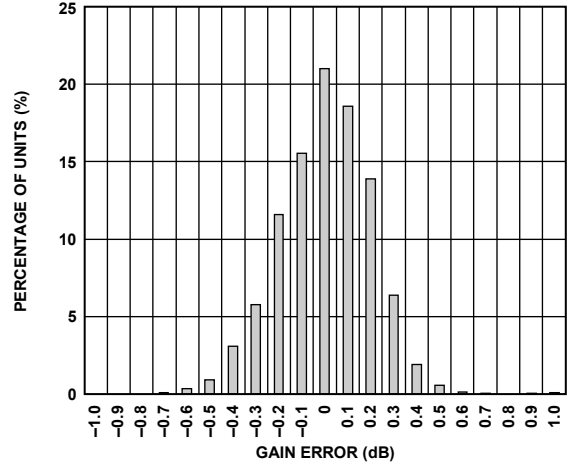

Figure 12. Gain Error Histogram,  $V_{GAIN} = 1.28$  V

11134-012

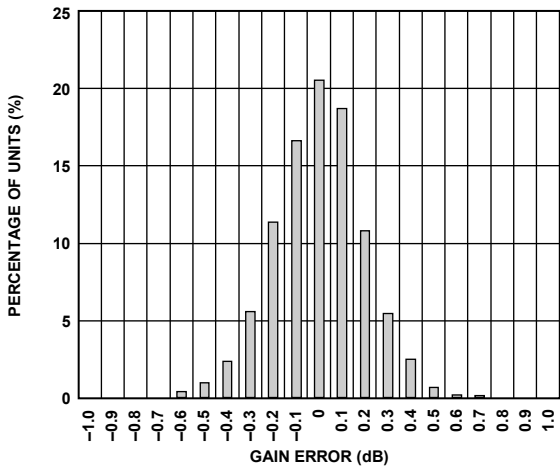

Figure 10. Gain Error Histogram,  $V_{GAIN} = -1.28$  V

11134-010

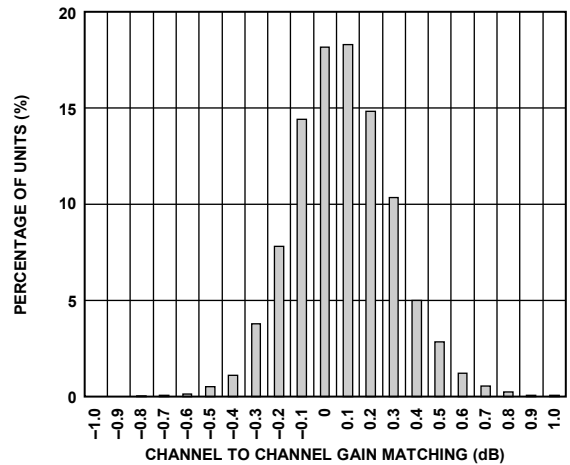

Figure 13. Gain Matching Histogram,  $V_{GAIN} = -1.2$  V

11134-013

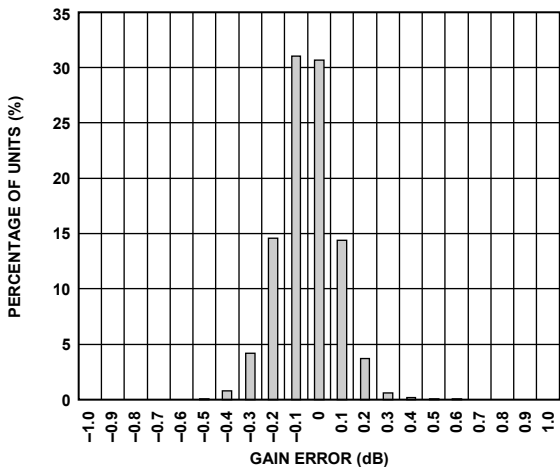

Figure 11. Gain Error Histogram,  $V_{GAIN} = 0$  V

11134-011

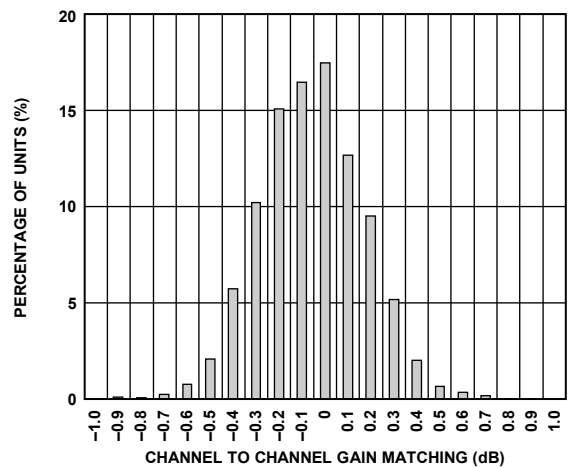

Figure 14. Gain Matching Histogram,  $V_{GAIN} = 1.2$  V

11134-014

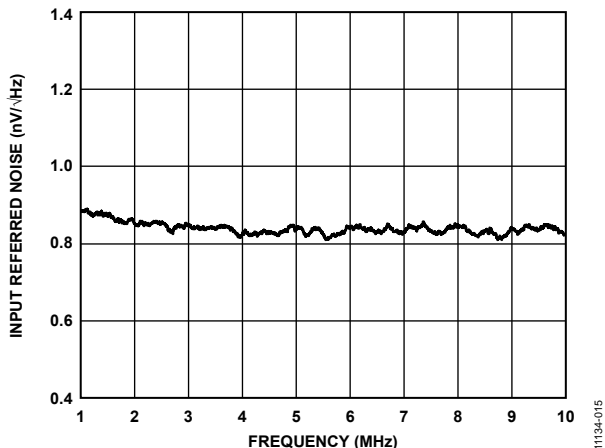

Figure 15. Short-Circuit, Input Referred Noise vs. Frequency

11134-015

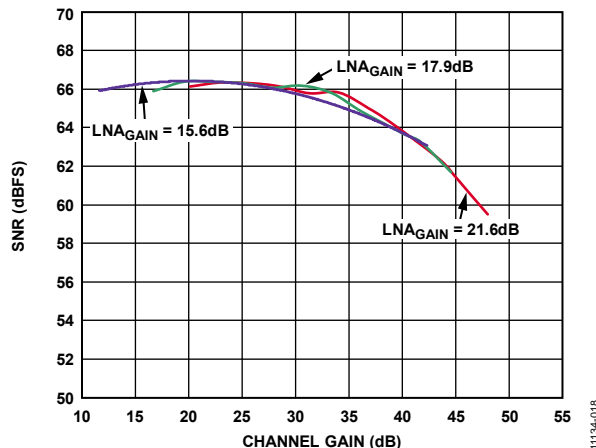

Figure 18. SNR vs. Channel Gain and LNA Gain,  $A_{OUT} = -1.0$  dBFS

11134-018

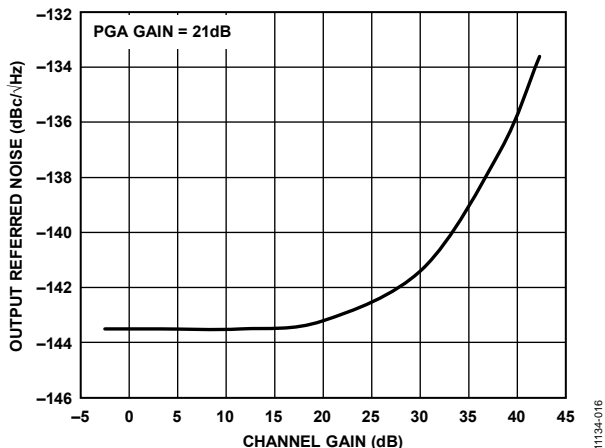

Figure 16. Short-Circuit, Output Referred Noise vs. Channel Gain, LNA Gain = 21.6 dB, PGA Gain = 21 dB,  $V_{GAIN} = 1.6$  V

11134-016

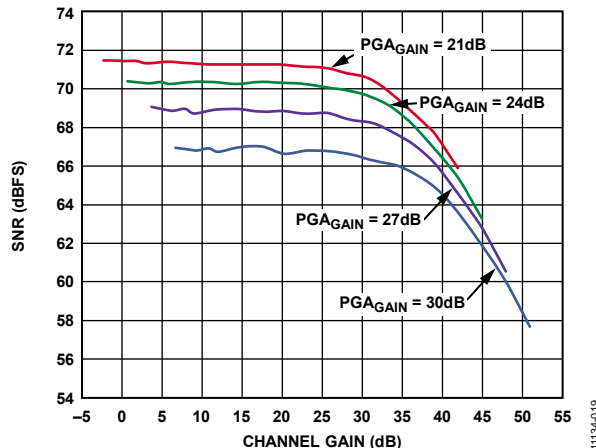

Figure 19. SNR vs. Channel Gain and PGA Gain,  $A_{IN} = -45$  dBm

11134-019

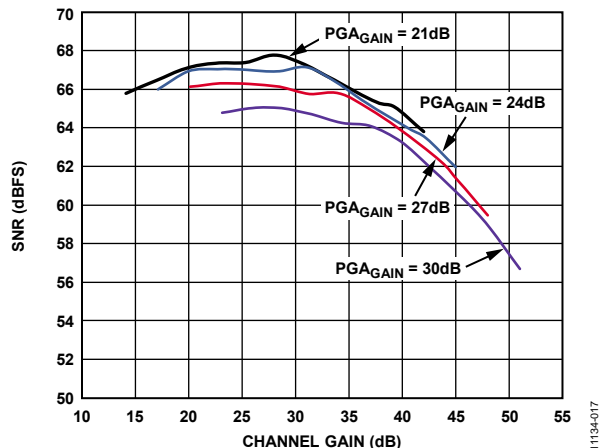

Figure 17. SNR vs. Channel Gain and PGA Gain,  $A_{OUT} = -1.0$  dBFS

11134-017

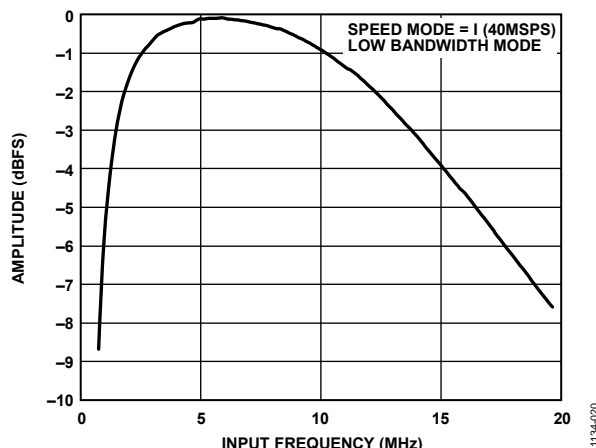

Figure 20. Antialiasing Filter (AAF) Pass-Band Response, LPF Cutoff =  $1 \times (1/3) \times f_{SAMPLE}$ , HPF =  $1/12 \times$  LPF Cutoff

11134-020

AD9671

Data Sheet

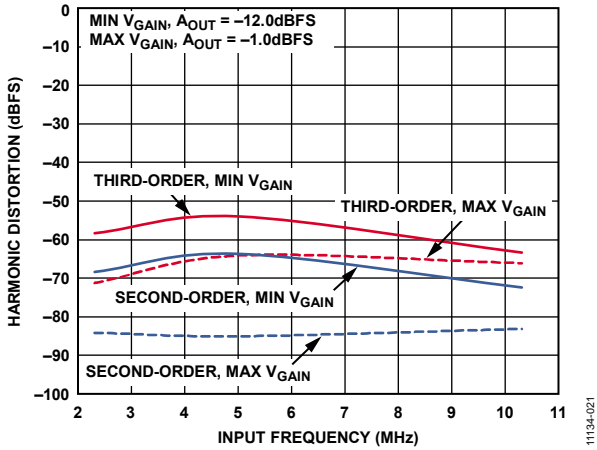

Figure 21. Second-Order and Third-Order Harmonic Distortion vs. Input Frequency

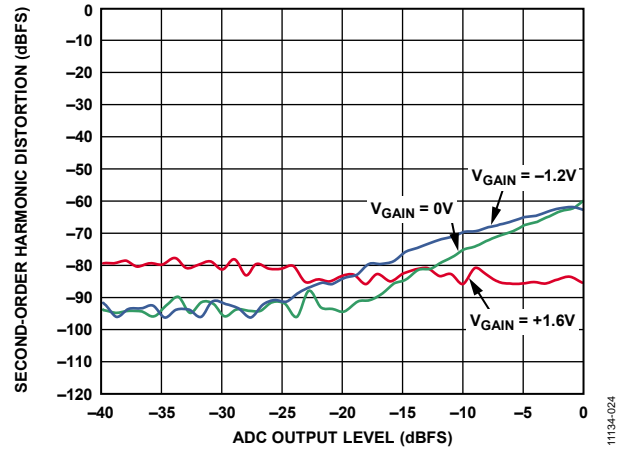

Figure 24. Second-Order Harmonic Distortion vs. ADC Output Level ( $A_{OUT}$ )

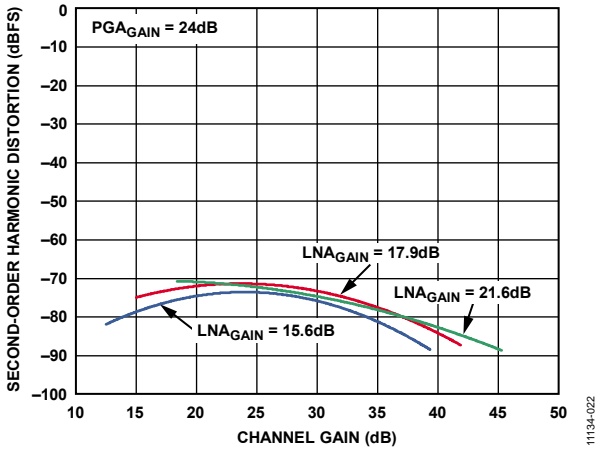

Figure 22. Second-Order Harmonic Distortion vs. Channel Gain,  $A_{OUT} = -1.0$  dBFS

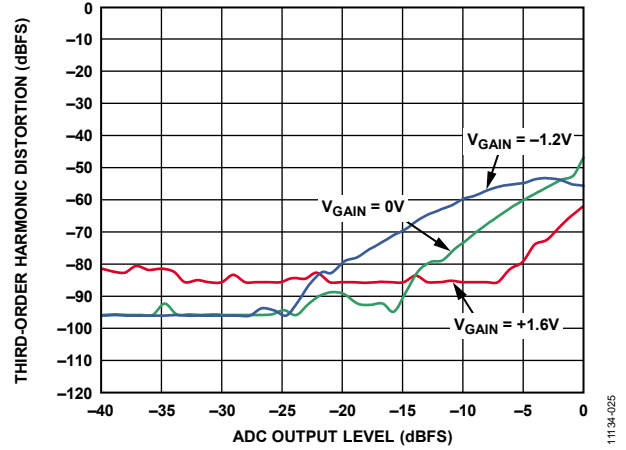

Figure 25. Third-Order Harmonic Distortion vs. ADC Output Level ( $A_{OUT}$ )

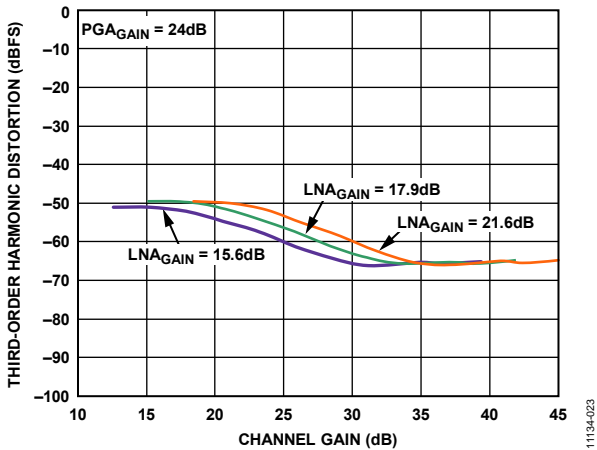

Figure 23. Third-Order Harmonic Distortion vs. Channel Gain,  $A_{OUT} = -1.0$  dBFS

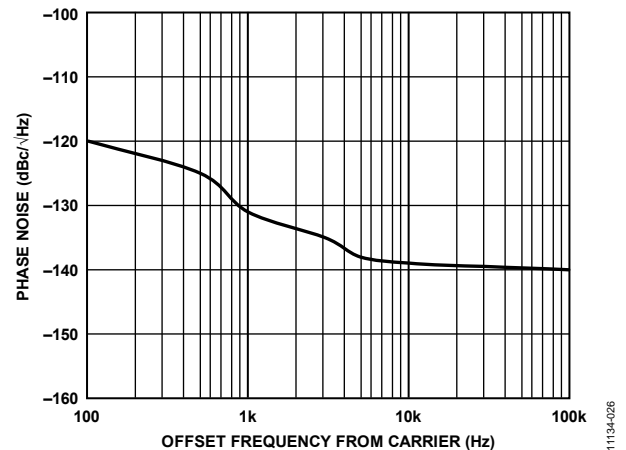

Figure 26. TGC Path Phase Noise, LNA Gain = 21.6 dB, PGA Gain = 27 dB,  $V_{GAIN} = 0$  V

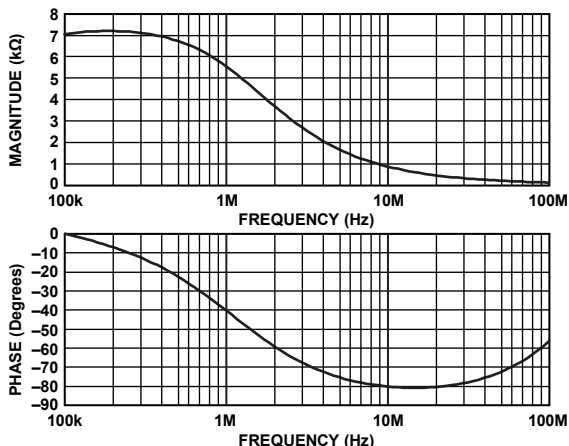

Figure 27. LNA Input Impedance Magnitude and Phase, Unterminated

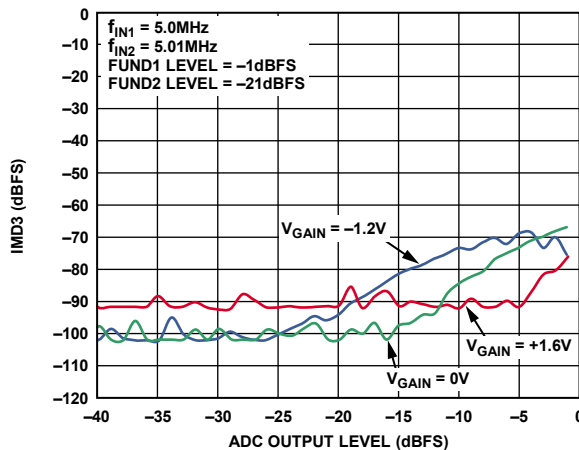

Figure 29. IMD3 vs. ADC Output Level

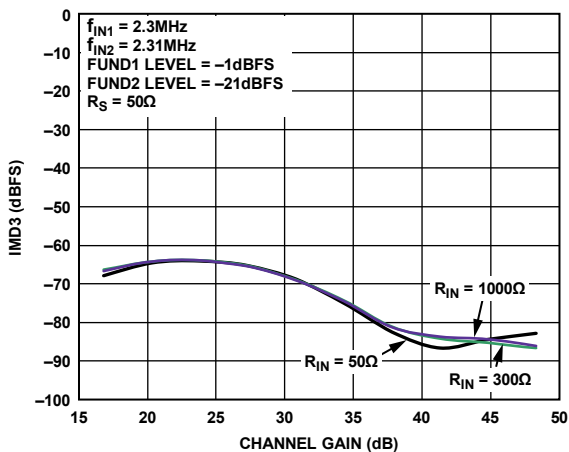

Figure 28. IMD3 vs. Channel Gain

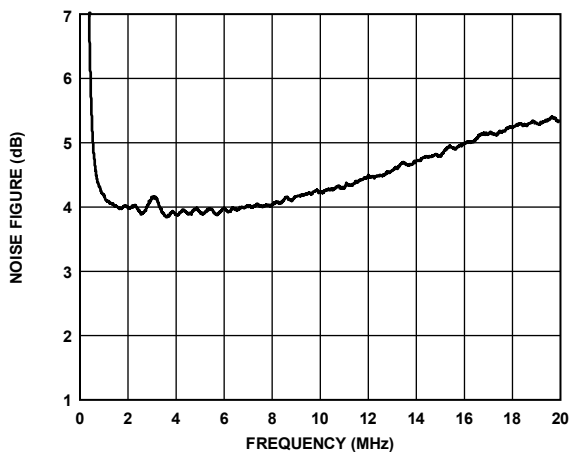

Figure 30. Noise Figure vs. Frequency  
 $R_S = R_{IN} = 100\Omega$ , LNA Gain = 17.9 dB, PGA Gain = 30 dB,  $V_{GAIN} = 1.6V$

**CW DOPPLER MODE**

$f_{IN} = 5$  MHz,  $f_{LO} = 20$  MHz, 4LO mode,  $R_S = 50 \Omega$ , LNA gain = 21.6 dB, LNA bias = midhigh, all CW channels enabled, phase rotation =  $0^\circ$ .

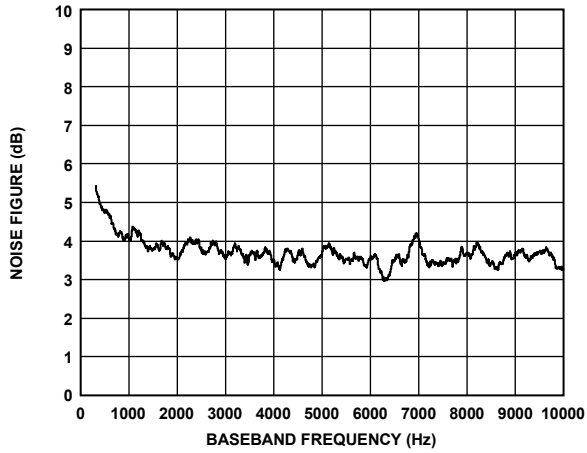

Figure 31. Noise Figure vs. Baseband Frequency

11134-032

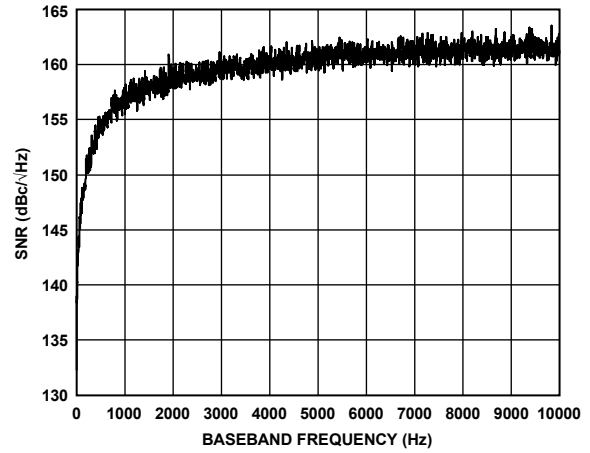

Figure 32. Output Referred SNR vs. Baseband Frequency

11134-033

## THEORY OF OPERATION

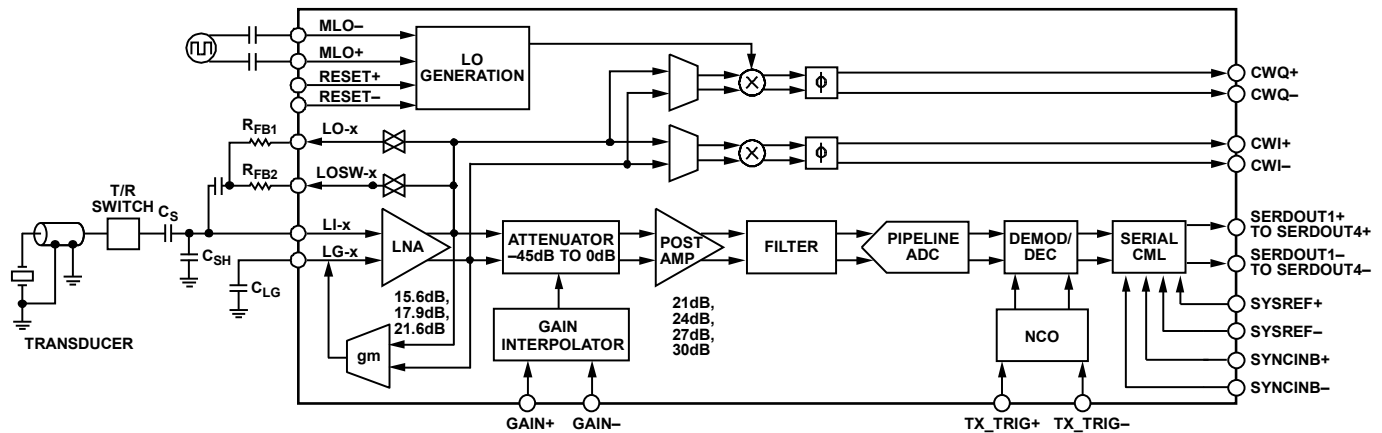

Figure 33. Simplified Block Diagram of a Single Channel

Each channel in the AD9671 contains both a TGC signal path and a CW Doppler signal path. Common to both signal paths, the LNA provides four user adjustable input impedance termination options for matching different probe impedances. The CW Doppler path includes an I/Q demodulator with programmable phase rotation needed for analog beamforming. The TGC path includes a differential X-AMP® VGA, an AAF, an ADC, and a digital demodulator and decimator. Figure 33 shows a simplified block diagram with external components.

### TGC OPERATION

The system gain for TGC operation is distributed as listed in Table 7.

Table 7. Channel Analog Gain Distribution

Section	Nominal Gain (dB)
LNA	15.6/17.9/21.6 (LNA <sub>GAIN</sub> )
Attenuator	-45 to 0 (VGA <sub>ATT</sub> )
VGA Amplifier	21/24/27/30 (PGA <sub>GAIN</sub> )
Filter	0
ADC	0

Each LNA output is dc-coupled to a VGA input. The VGA consists of an attenuator with a range of -45 dB to 0 dB followed by an amplifier with 21 dB, 24 dB, 27 dB, or 30 dB of gain. The X-AMP gain interpolation technique results in low gain error and uniform bandwidth, and differential signal paths minimize distortion.

The linear in dB gain (law conformance) range of the TGC path is 45 dB. The slope of the gain control interface is 14 dB/V, and the gain control range is -1.6 V to +1.6 V. Equation 1 is the expression for the differential voltage,  $V_{GAIN}$ , at the gain control interface. Equation 2 is the expression for the VGA attenuation,  $VGA_{ATT}$ , as a function of  $V_{GAIN}$ .

$$V_{GAIN} (V) = (GAIN+) - (GAIN-) \quad (1)$$

$$VGA_{ATT} (dB) = -14 (dB/V) \times (1.6 - V_{GAIN}) \quad (2)$$

Then calculate the total channel gain as in Equation 3.

$$ChannelGain (dB) = LNA_{GAIN} + VGA_{ATT} + PGA_{GAIN} \quad (3)$$

In its default condition, the LNA has a gain of 21.6 dB (12×), and the VGA postamplifier gain is 24 dB. If the voltage on the GAIN+ pin is 0 V and the voltage on the GAIN- pin is 1.6 V (44.8 dB attenuation), the total gain of the channel is 0.8 dB if the LNA input is unmatched. The channel gain is -5.2 dB if the LNA is matched to 50 Ω ( $R_{FB} = 300 \Omega$ ). However, if the voltage on the GAIN+ pin is 1.6 V and the voltage on the GAIN- pin is 0 V (0 dB attenuation),  $VGA_{ATT}$  is 0 dB. This results in a total gain of 45.6 dB through the TGC path if the LNA input is unmatched, or in a total gain of 39.6 dB if the LNA input is matched. Similarly, if the LNA input is unmatched and has a gain of 21.6 dB (12×), and the VGA postamp gain is 30 dB, the channel gain is approximately 52 dB with 0 dB  $VGA_{ATT}$ .

In addition to the analog VGA attenuation described in Equation 2, the attenuation level can be digitally controlled in 3.5 dB increments. Equation 3 is still valid, and the value of  $VGA_{ATT}$  is equal to the attenuation level set in Address 0x011, Bits[7:4].

### Low Noise Amplifier (LNA)

Good system sensitivity relies on a proprietary ultralow noise LNA at the beginning of the signal chain, which minimizes the noise contribution in the following VGA. Active impedance control optimizes noise performance for applications that benefit from input impedance matching.

The LNA input, LI-x, is capacitively coupled to the source. An on-chip bias generator establishes dc input bias voltages of approximately 2.2 V and centers the output common-mode levels at 1.5 V ( $AVDD2$  divided by 2). A capacitor,  $C_{LG}$ , of the same value as the input coupling capacitor,  $C_s$ , is connected from the LG-x pin to ground.

The LNA supports three gains, 21.6 dB, 17.9 dB, or 15.6 dB, set through the SPI. Overload protection ensures quick recovery time from large input voltages.

Low value feedback resistors and the current driving capability of the output stage allow the LNA to achieve a low input referred noise voltage of 0.78 nV/√Hz (at a gain of 21.6 dB).

On-chip resistor matching results in precise single-ended gains,

which are critical for accurate impedance control. The use of a fully differential topology and negative feedback minimizes distortion. Low second-order harmonic distortion is particularly important in harmonic ultrasound imaging applications.

### Active Impedance Matching

The LNA consists of a single-ended voltage gain amplifier with differential outputs. The negative output is externally available on two output pins, LO-x and LOSW-x, that are controlled via internal switches. This configuration allows the active input impedance synthesis of three different impedance values (and an unterminated value) by connecting up to two external resistances in parallel and controlling the internal switch states via the SPI. For example, with a fixed gain of  $8\times$  (17.9 dB), an active input termination is synthesized by connecting a feedback resistor between the negative output pin, LO-x, and the positive input pin, LI-x. This well known technique is used for interfacing multiple probe impedances to a single system. The input resistance ( $R_{IN}$ ) calculation is shown in Equation 4.

$$R_{IN} = \frac{(R_{FB1} + 20\ \Omega) \parallel (R_{FB2} + 20\ \Omega) + 30\ \Omega}{\left(1 + \frac{A}{2}\right)} \quad (4)$$

where:

$R_{FB1}$  and  $R_{FB2}$  are the external feedback resistors.

20  $\Omega$  is the internal switch on resistance.

30  $\Omega$  is an internal series resistance common to the two internal switches.

$A/2$  is the single-ended gain or the gain from the LI-x inputs to the LO-x outputs.

$R_{FB}$  can be equal to  $R_{FB1}$ ,  $R_{FB2}$ , or  $(R_{FB1} + 20\ \Omega) \parallel (R_{FB2} + 20\ \Omega)$  depending on the connection status of the internal switches.

Because the amplifier has a gain of  $8\times$  from its input to its differential output, it is important to note that the gain,  $A/2$ , is the gain from Pin LI-x to Pin LO-x and that it is 6 dB less than the gain of the amplifier, or 12.1 dB ( $4\times$ ). The input resistance is reduced by an internal bias resistor of 6 k $\Omega$  in parallel with the source resistance connected to Pin LI-x, with Pin LG-x ac grounded. Use the more accurate Equation 5 to calculate the required  $R_{FB}$  for a desired  $R_{IN}$ , even for higher values of  $R_{IN}$ .

$$R_{IN} = \frac{(R_{FB1} + 20\ \Omega) \parallel (R_{FB2} + 20\ \Omega) + 30\ \Omega}{\left(1 + \frac{A}{2}\right)} \parallel 6\ \text{k}\Omega \quad (5)$$

For example, to set  $R_{IN}$  to 200  $\Omega$  with a single-ended LNA gain of 12.1 dB ( $4\times$ ), the value of  $R_{FB1}$  from Equation 1 must be 950  $\Omega$  while the switch for  $R_{FB2}$  is open. If the more accurate equation (Equation 5) is used to calculate  $R_{IN}$ , the value is then 194  $\Omega$  instead of 200  $\Omega$ , resulting in a gain error of less than 0.27 dB. Some factors, such as the presence of a dynamic source resistance, may influence the absolute gain accuracy more significantly. At higher frequencies, the input capacitance of the LNA must be considered. The user must determine the level of matching accuracy and adjust  $R_{FB}$  accordingly.

$R_{FB}$  is the resulting impedance of the  $R_{FB1}$  and  $R_{FB2}$  combination (see Figure 33). Use Register 0x02C in the SPI memory to program the AD9671 for four impedance matching options: three active terminations and unterminated. Table 8 shows an example of how to select  $R_{FB1}$  and  $R_{FB2}$  for 66  $\Omega$ , 100  $\Omega$ , and 200  $\Omega$  input impedance for LNA gain = 21.6 dB ( $12\times$ ).

**Table 8. Active Termination Example for LNA Gain = 21.6 dB,  $R_{FB1} = 650\ \Omega$ ,  $R_{FB2} = 1350\ \Omega$**

Addr. 0x02C Value	$R_s$ ( $\Omega$ )	LO-x Switch	LOSW-x Switch	$R_{FB}$ ( $\Omega$ )	$R_{IN}$ ( $\Omega$ ) (Eq. 4)
00 (default)	100	On	Off	$R_{FB1}$	100
01	50	On	On	$R_{FB1} \parallel R_{FB2}$	66
10	200	Off	On	$R_{FB2}$	200
11	N/A <sup>1</sup>	Off	Off	$\infty$	$\infty$

<sup>1</sup> N/A means not applicable.

The bandwidth (BW) of the LNA is greater than 80 MHz. Ultimately, the BW of the LNA limits the accuracy of the synthesized  $R_{IN}$ . For  $R_{IN} = R_s$  up to about 200  $\Omega$ , the best match is between 100 kHz and 10 MHz, where the lower frequency limit is determined by the size of the ac coupling capacitors, and the upper limit is determined by the LNA BW. Furthermore, the input capacitance and  $R_s$  limit the BW at higher frequencies. Figure 34 shows  $R_{IN}$  vs. frequency for various values of  $R_{FB}$ .

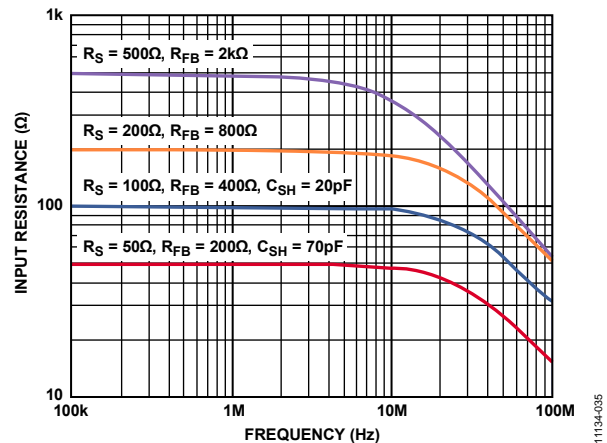

Figure 34.  $R_{IN}$  vs. Frequency for Various Values of  $R_{FB}$  (Effects of  $R_{SH}$  and  $C_{SH}$  Are Also Shown)

However, for larger  $R_{IN}$  values, parasitic capacitance starts rolling off the signal BW before the LNA can produce peaking.  $C_{SH}$  further degrades the match; therefore, do not use  $C_{SH}$  for values of  $R_{IN}$  that are greater than 100  $\Omega$ .

Table 9 lists the recommended values for  $R_{FB}$  and  $C_{SH}$  in terms of  $R_{IN}$ .  $C_{FB}$  is needed in series with  $R_{FB}$  because the dc levels at Pin LO-x and Pin LI-x are unequal.

**Table 9. Active Termination External Component Values**

LNA Gain (dB)	$R_{IN}$ ( $\Omega$ )	$R_{FB}$ ( $\Omega$ )	Minimum $C_{SH}$ (pF)
15.6	50	150	90
17.9	50	200	70
21.6	50	300	50
15.6	100	350	30
17.9	100	450	20
21.6	100	650	10
15.6	200	750	Not applicable
17.9	200	950	Not applicable
21.6	200	1350	Not applicable

### LNA Noise

The short-circuit noise voltage (input referred noise) is an important limit on system performance. The short-circuit noise voltage for the LNA is 0.78 nV/ $\sqrt{\text{Hz}}$  at a gain of 21.6 dB, including the VGA noise at a VGA postamp gain of 27 dB. These measurements, which were taken without a feedback resistor, provide the basis for calculating the input noise and noise figure (NF) performance.

Figure 35 and Figure 36 are simulations of noise figure vs.  $R_S$  results with different input configurations and an input referred noise voltage of 2.5 nV/ $\sqrt{\text{Hz}}$  for the VGA. Underterminated ( $R_{FB} = \infty$ ) operation exhibits the lowest equivalent input noise and noise figure. Figure 36 shows the noise figure vs. source resistance rising at low  $R_S$ , where the LNA voltage noise is large compared with the source noise, and at high  $R_S$  due to the noise contribution from  $R_{FB}$ . The lowest NF is achieved when  $R_S$  matches  $R_{IN}$ .

Figure 35 shows the relative noise figure performance. With an LNA gain of 21.6 dB, the input impedance is swept with  $R_S$  to preserve the match at each point. The noise figures for a source impedance of 50  $\Omega$  are 7 dB, 4 dB, and 2.5 dB for the shunt termination, active termination, and unterminated configurations, respectively. The noise figures for 200  $\Omega$  are 4.5 dB, 1.7 dB, and 1 dB, respectively.

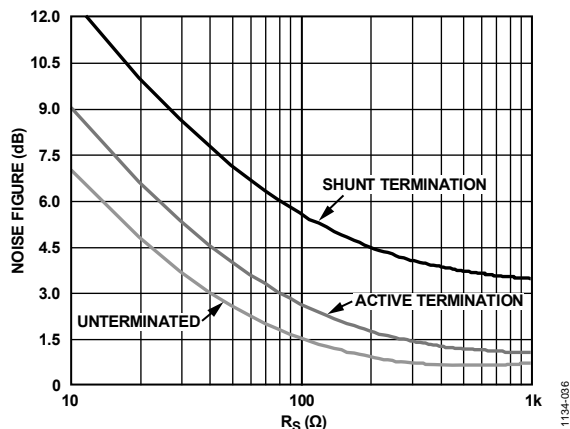

Figure 35. Noise Figure vs.  $R_S$  for Shunt Termination, Active Termination Matched and Unterminated Inputs,  $V_{GAIN} = 1.6 \text{ V}$

Figure 36 shows the noise figure as it relates to  $R_S$  for various values of  $R_{IN}$ , which is helpful for design purposes.

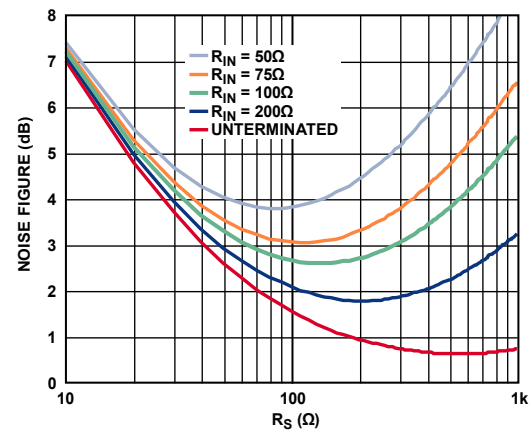

Figure 36. Noise Figure vs.  $R_S$  for Various Fixed Values of  $R_{IN}$ , Active Termination Matched Inputs,  $V_{GAIN} = 1.6 \text{ V}$

### CLNA Connection

CLNA (Pin B7) must have a 1 nF capacitor attached to AVDD2.

### DC Offset Correction/High-Pass Filter

The AD9671 LNA architecture is designed to correct for dc offset voltages that can develop on the external  $C_S$  capacitor due to leakage of the Tx/Rx switch during ultrasound transmit cycles. The dc offset correction, as shown in Figure 37, provides a feedback mechanism to the LG-x input of the LNA to correct for this dc voltage.

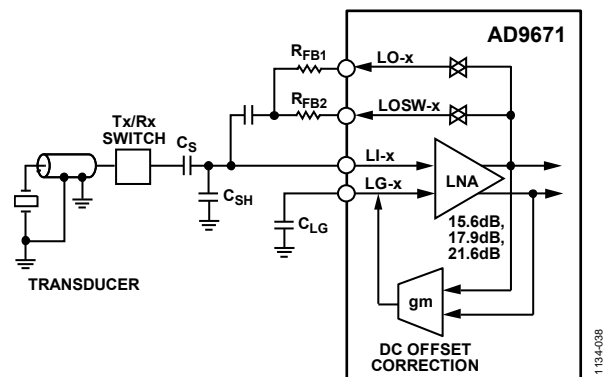

Figure 37. Simplified LNA Input Configuration

The feedback acts as high-pass filter providing dynamic correction of the dc offset. The cutoff frequency of the high-pass filter response is dependent on the value of the  $C_{LG}$  capacitor, the gain of the LNA ( $LNA_{GAIN}$ ) and the transconductance ( $g_m$ ) of the feedback transconductance amplifier. The  $g_m$  value is programmed in Register 0x120, Bits[4:3]. Ensure that  $C_S$  is equal to  $C_{LG}$  for proper operation.

## AD9671

## Data Sheet

Table 10. High-Pass Filter Cutoff Frequency,  $f_{HP}$ , for  $C_{LG} = 10$  nF

Address 0x120[4:3]	$g_m$ (mS)	$LNA_{GAIN} =$ 15.6 dB	$LNA_{GAIN} =$ 17.9 dB	$LNA_{GAIN} =$ 21.6 dB
00 (default)	0.5	41 kHz	55 kHz	83 kHz
01	1.0	83 kHz	110 kHz	167 kHz
10	1.5	133 kHz	178 kHz	267 kHz
11	2.0	167 kHz	220 kHz	330 kHz

For other values of  $C_{LG}$ , determine the high-pass filter cutoff frequency by scaling the values from Table 10 or calculating based on  $C_{LG}$ ,  $LNA_{GAIN}$ , and  $g_m$ , as shown in Equation 6.

$$f_{HP}(C_{LG}) = \frac{1}{2 \times \pi} \times LNA_{GAIN} \times \frac{g_m}{C_{LG}} = f_{HP} \times \frac{10 \text{ nF}}{C_{LG}} \quad (6)$$

where  $f_{HP}$  is the high-pass filter cutoff frequency (see Table 10).

### Variable Gain Amplifier (VGA)

The differential X-AMP VGA provides precise input attenuation and interpolation. It has a low input referred noise of 2.5 nV/ $\sqrt{\text{Hz}}$  and excellent gain linearity. The VGA is driven by a fully differential input signal from the LNA. The X-AMP architecture produces a linear in dB gain law conformance and low distortion levels—deviating only  $\pm 0.5$  dB or less from the ideal. The gain slope is monotonic with respect to the control voltage and is stable with variations in process, temperature, and supply. The resulting total gain range is 45 dB, which allows for range loss at the endpoints.

The X-AMP inputs are part of a PGA that completes the VGA. The PGA in the VGA can be programmed to a gain of 21 dB, 24 dB, 27 dB, or 30 dB, allowing optimization of channel gain for different imaging modes in the ultrasound system. The VGA bandwidth is greater than 100 MHz. The input stage is designed to ensure excellent frequency response uniformity across the gain setting. For TGC mode, this input stage minimizes time delay variation across the gain range.

### Gain Control

The analog gain control interface,  $GAIN_{\pm}$ , is a differential input.  $V_{GAIN}$  varies the gain of all VGAs through the interpolator by selecting the appropriate input stages connected to the input attenuator. The nominal  $V_{GAIN}$  range is 14 dB/V from  $-1.6$  V to  $+1.6$  V, with the best gain linearity from approximately  $-1.44$  V to  $+1.44$  V, where the error is typically less than  $\pm 0.5$  dB. For  $V_{GAIN}$  voltages of greater than 1.44 V and less than  $-1.44$  V, the error increases. The value of  $GAIN_{\pm}$  can exceed the supply voltage by 1 V without gain foldover.

Gain control response time is typically 750 ns to settle within 10% of the final value for a change from minimum to maximum gain.

The differential input pins,  $GAIN+$  and  $GAIN-$ , can interface to an amplifier, as shown in Figure 38. Decouple and drive the  $GAIN+$  and  $GAIN-$  pins to accommodate a 3.2 V full-scale input.

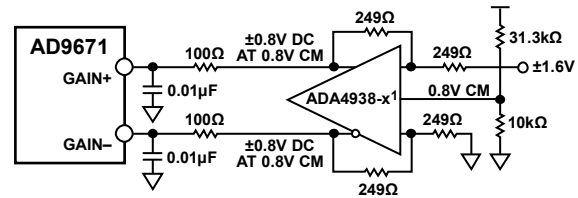

<sup>1</sup>ADA4938-x REFERS TO THE ADA4938-1 AND ADA4938-2 DEVICES

Figure 38. Differential  $GAIN_{\pm}$  Pin Configuration

Use Address 0x011, Bits[7:4], to disable the analog gain control and to control the attenuator digitally. The control range is 45 dB and the step size is 3.5 dB.

### VGA Noise

In a typical application, a VGA compresses a wide dynamic range input signal to within the input span of an ADC. The input referred noise of the LNA limits the minimum resolvable input signal, whereas the output referred noise, which depends primarily on the VGA, limits the maximum instantaneous dynamic range that can be processed at any one particular gain control voltage. This latter limit is set in accordance with the total noise floor of the ADC.

The output referred noise is a flat 40 nV/ $\sqrt{\text{Hz}}$  (postamp gain = 24 dB) over most of the gain range because it is dominated by the fixed output referred noise of the VGA. At the high end of the gain control range, the noise of the LNA and the source prevail. The input referred noise reaches its minimum value near the maximum gain control voltage, where the input referred contribution of the VGA is miniscule.

At lower gains, the input referred noise and, therefore, the noise figure increase as the gain decreases. The instantaneous dynamic range of the system is not lost, however, because the input capacity increases as the input referred noise increases. The contribution of the ADC noise floor has the same dependence. The important relationship is the magnitude of the VGA output noise floor relative to that of the ADC.

Gain control noise is a concern in very low noise applications. Thermal noise in the gain control interface can modulate the channel gain. The resulting noise is proportional to the output signal level and is usually evident only when a large signal is present. Take care to minimize noise impinging at the  $GAIN_{\pm}$  inputs. Use an external RC filter to remove  $V_{GAIN}$  source noise. Ensure that the filter bandwidth is sufficient to accommodate the desired control bandwidth and attenuate unwanted switching noise from the external DACs used to drive the gain control.

The AD9671 can bypass the  $GAIN_{\pm}$  inputs and control the gain of the attenuator digitally (see the Gain Control section). This mode removes any external noise contributions when active gain control is not needed.

**Antialiasing Filter (AAF)**

The filter that the signal reaches prior to the ADC is used to reject dc signals and to band limit the signal for antialiasing. The antialiasing filter is a combination of a single-pole, high-pass filter and a second-order, low-pass filter. Configure the high-pass filter as a ratio of the low-pass filter cutoff frequency using Address 0x02B, Bits[1:0].

The filter uses on-chip tuning to trim the capacitors and, in turn, to set the desired low-pass cutoff frequency and reduce variations. The default –3 dB low-pass filter cutoff is 1/3, 1/4.5, or 1/6 of the ADC sample clock rate. The cutoff can be scaled to 0.75, 0.8, 0.9, 1.0, 1.13, 1.25, or 1.45 times this frequency using Address 0x00F. The cutoff tolerance ( $\pm 10\%$ ) is maintained from 8 MHz to 18 MHz for low bandwidth mode or 13.5 MHz to 30 MHz for high bandwidth mode.

Table 11 and Table 12 calculate the valid SPI-selectable low-pass filter settings and expected cutoff frequencies for the low bandwidth and high bandwidth modes at the minimum sample

frequency and the maximum sample frequency in each speed mode.

Tuning is normally off to avoid changing the capacitor settings during critical times. The tuning circuit is enabled through the SPI. It is disabled automatically after 512 cycles of the ADC sample clock. Initialize the tuning of the filter after initial power-up and after reprogramming of the filter cutoff scaling or the ADC sample rate. The tuning is initiated using Address 0x02B, Bit 6.

Four SPI-programmable settings allow users to vary the high-pass filter cutoff frequency as a function of the low-pass cutoff frequency. Two examples are shown in Table 13: an 8 MHz low-pass cutoff frequency and an 18 MHz low-pass cutoff frequency. In both cases, as the ratio decreases, the amount of rejection on the low end frequencies increases. Therefore, making the entire AAF frequency pass band narrow can reduce low frequency noise or maximize dynamic range for harmonic processing.

**Table 11. SPI-Selectable Low-Pass Filter Cutoff Options for Low Bandwidth Mode at Example Sampling Frequencies**

Address 0x00F, Bits[7:3]	LPF Cutoff Frequency (MHz)	Sampling Frequency (MHz)				
		20.5	40	65	80	125
0 0000	$1.45 \times (1/3) \times f_{\text{SAMPLE}}$	9.91	Out of tunable filter range	Out of tunable filter range	Out of tunable filter range	Out of tunable filter range
0 0001	$1.25 \times (1/3) \times f_{\text{SAMPLE}}$	8.54	16.67	Out of tunable filter range	Out of tunable filter range	Out of tunable filter range
0 0010	$1.13 \times (1/3) \times f_{\text{SAMPLE}}$	Out of tunable filter range	15.00	Out of tunable filter range	Out of tunable filter range	Out of tunable filter range
0 0011	$1.0 \times (1/3) \times f_{\text{SAMPLE}}$	Out of tunable filter range	13.33	Out of tunable filter range	Out of tunable filter range	Out of tunable filter range
0 0100	$0.9 \times (1/3) \times f_{\text{SAMPLE}}$	Out of tunable filter range	12.00	Out of tunable filter range	Out of tunable filter range	Out of tunable filter range
0 0101	$0.8 \times (1/3) \times f_{\text{SAMPLE}}$	Out of tunable filter range	10.67	17.33	Out of tunable filter range	Out of tunable filter range
0 0110	$0.75 \times (1/3) \times f_{\text{SAMPLE}}$	Out of tunable filter range	10.00	16.25	16.82	Out of tunable filter range
0 1000	$1.45 \times (1/4.5) \times f_{\text{SAMPLE}}$	Out of tunable filter range	12.89	20.94	Out of tunable filter range	Out of tunable filter range
0 1001	$1.25 \times (1/4.5) \times f_{\text{SAMPLE}}$	Out of tunable filter range	11.11	18.06	Out of tunable filter range	Out of tunable filter range
0 1010	$1.13 \times (1/4.5) \times f_{\text{SAMPLE}}$	Out of tunable filter range	10.00	16.25	Out of tunable filter range	Out of tunable filter range
0 1011	$1.0 \times (1/4.5) \times f_{\text{SAMPLE}}$	Out of tunable filter range	8.89	14.44	17.78	Out of tunable filter range
0 1100	$0.9 \times (1/4.5) \times f_{\text{SAMPLE}}$	Out of tunable filter range	8.00	13.00	16.00	Out of tunable filter range
0 1101	$0.8 \times (1/4.5) \times f_{\text{SAMPLE}}$	Out of tunable filter range	Out of tunable filter range	11.56	14.22	Out of tunable filter range
0 1110	$0.75 \times (1/4.5) \times f_{\text{SAMPLE}}$	Out of tunable filter range	Out of tunable filter range	10.83	13.33	17.50

**AD9671****Data Sheet**

Address 0x00F, Bits[7:3]	LPF Cutoff Frequency (MHz)	Sampling Frequency (MHz)				
		20.5	40	65	80	125
1 0000	$1.45 \times (1/6) \times f_{\text{SAMPLE}}$	Out of tunable filter range	9.67	15.71	Out of tunable filter range	Out of tunable filter range
1 0001	$1.25 \times (1/6) \times f_{\text{SAMPLE}}$	Out of tunable filter range	8.33	13.54	16.67	Out of tunable filter range
1 0010	$1.13 \times (1/6) \times f_{\text{SAMPLE}}$	Out of tunable filter range	Out of tunable filter range	12.19	15.00	Out of tunable filter range
1 0011	$1.0 \times (1/6) \times f_{\text{SAMPLE}}$	Out of tunable filter range	Out of tunable filter range	10.83	13.33	Out of tunable filter range
1 0100	$0.9 \times (1/6) \times f_{\text{SAMPLE}}$	Out of tunable filter range	Out of tunable filter range	9.75	12.00	Out of tunable filter range
1 0101	$0.8 \times (1/6) \times f_{\text{SAMPLE}}$	Out of tunable filter range	Out of tunable filter range	8.67	10.67	16.67
1 0110	$0.75 \times (1/6) \times f_{\text{SAMPLE}}$	Out of tunable filter range	Out of tunable filter range	8.13	10.00	15.63

**Table 12. SPI-Selectable Low-Pass Filter Cutoff Options for High Bandwidth Mode at Example Sampling Frequencies**

Address 0x00F, Bits[7:3]	LPF Cutoff Frequency (MHz)	Sampling Frequency (MHz)				
		20.5	40	65	80	125
0 0000	$1.45 \times (1/3) \times f_{\text{SAMPLE}}$	Out of tunable filter range	19.33	Out of tunable filter range	Out of tunable filter range	Out of tunable filter range
0 0001	$1.25 \times (1/3) \times f_{\text{SAMPLE}}$	Out of tunable filter range	16.67	27.08	Out of tunable filter range	Out of tunable filter range
0 0010	$1.13 \times (1/3) \times f_{\text{SAMPLE}}$	Out of tunable filter range	15.00	24.38	30.00	Out of tunable filter range
0 0011	$1.0 \times (1/3) \times f_{\text{SAMPLE}}$	Out of tunable filter range	Out of tunable filter range	21.67	26.67	Out of tunable filter range
0 0100	$0.9 \times (1/3) \times f_{\text{SAMPLE}}$	Out of tunable filter range	Out of tunable filter range	19.50	24.00	Out of tunable filter range
0 0101	$0.8 \times (1/3) \times f_{\text{SAMPLE}}$	Out of tunable filter range	Out of tunable filter range	17.33	21.33	Out of tunable filter range
0 0110	$0.75 \times (1/3) \times f_{\text{SAMPLE}}$	Out of tunable filter range	Out of tunable filter range	16.25	20.00	Out of tunable filter range
0 1000	$1.45 \times (1/4.5) \times f_{\text{SAMPLE}}$	Out of tunable filter range	Out of tunable filter range	20.94	25.78	Out of tunable filter range
0 1001	$1.25 \times (1/4.5) \times f_{\text{SAMPLE}}$	Out of tunable filter range	Out of tunable filter range	18.06	22.22	Out of tunable filter range
0 1010	$1.13 \times (1/4.5) \times f_{\text{SAMPLE}}$	Out of tunable filter range	Out of tunable filter range	16.25	20.00	Out of tunable filter range
0 1011	$1.0 \times (1/4.5) \times f_{\text{SAMPLE}}$	Out of tunable filter range	Out of tunable filter range	14.44	17.78	27.78
0 1100	$0.9 \times (1/4.5) \times f_{\text{SAMPLE}}$	Out of tunable filter range	Out of tunable filter range	Out of tunable filter range	16.00	25.00
0 1101	$0.8 \times (1/4.5) \times f_{\text{SAMPLE}}$	Out of tunable filter range	Out of tunable filter range	Out of tunable filter range	14.22	22.22
0 1110	$0.75 \times (1/4.5) \times f_{\text{SAMPLE}}$	Out of tunable filter range	Out of tunable filter range	Out of tunable filter range	Out of tunable filter range	20.83

Address 0x00F, Bits[7:3]	LPF Cutoff Frequency (MHz)	Sampling Frequency (MHz)				
		20.5	40	65	80	125
1 0000	$1.45 \times (1/6) \times f_{\text{SAMPLE}}$	Out of tunable filter range	Out of tunable filter range	15.71	19.33	Out of tunable filter range
1 0001	$1.25 \times (1/6) \times f_{\text{SAMPLE}}$	Out of tunable filter range	Out of tunable filter range	13.54	16.67	26.04
1 0010	$1.13 \times (1/6) \times f_{\text{SAMPLE}}$	Out of tunable filter range	Out of tunable filter range	Out of tunable filter range	15.00	23.44
1 0011	$1.0 \times (1/6) \times f_{\text{SAMPLE}}$	Out of tunable filter range	Out of tunable filter range	Out of tunable filter range	Out of tunable filter range	20.83
1 0100	$0.9 \times (1/6) \times f_{\text{SAMPLE}}$	Out of tunable filter range	Out of tunable filter range	Out of tunable filter range	Out of tunable filter range	18.75
1 0101	$0.8 \times (1/6) \times f_{\text{SAMPLE}}$	Out of tunable filter range	Out of tunable filter range	Out of tunable filter range	Out of tunable filter range	16.67
1 0110	$0.75 \times (1/6) \times f_{\text{SAMPLE}}$	Out of tunable filter range	Out of tunable filter range	Out of tunable filter range	Out of tunable filter range	15.63

Table 13. High-Pass Filter Cutoff Options

Address 0x02B[1:0] High-Pass Filter Cutoff	Ratio <sup>1</sup>	High-Pass Cutoff Frequency	
		Low-Pass Cutoff = 8 MHz	Low-Pass Cutoff = 18 MHz
00 (default)	12.00	670 kHz	1.5 MHz
01	9.00	890 kHz	2.0 MHz
10	6.00	1.33 MHz	3.0 MHz
11	3.00	2.67 MHz	6.0 MHz

<sup>1</sup> Ratio = low-pass filter cutoff frequency/high-pass filter cutoff frequency.

### AAF/VGA Test Mode

For debug and testing, there is a bypass switch to view the AAF output on the GPO2 and GPO3 pins. Enable this mode via SPI Address 0x109, Bit 4. The differential AAF output of only one channel can be accessed at a time. The dc output voltage is 1.5 V (or AVDD2/2) and the maximum ac output voltage is 2 V p-p.

### ADC

The AD9671 uses a pipelined ADC architecture. The quantized output from each stage is combined into a 14-bit result in the digital correction logic. The pipelined architecture permits the first stage to operate on a new input sample and the remaining stages to operate on preceding samples. Sampling occurs on the rising edge of the clock.

The output staging block aligns the data, corrects errors, and passes the data to the output buffers. The data is then serialized and aligned to the frame and output clocks.

### Clock Input Considerations

For optimum performance, clock the AD9671 sample clock inputs (CLK+ and CLK-) with a differential signal. This signal is typically ac-coupled into the CLK+ and CLK- pins via a transformer or capacitors. These pins are biased internally and require no additional bias.

Figure 39 shows the preferred method for clocking the AD9671. A low jitter clock source, such as the Valpey Fisher oscillator, VFAC3AHL-1 80.000, is converted from single-ended to differential using an RF transformer. The back to back Schottky diodes across the secondary transformer limit clock excursions

into the AD9671 to approximately 0.8 V p-p differential. This limit prevents the large voltage swings of the clock from feeding through to other portions of the AD9671, and it preserves the fast rise and fall times of the signal, which are critical to low jitter performance.

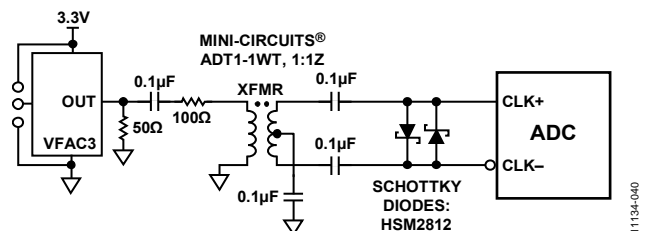
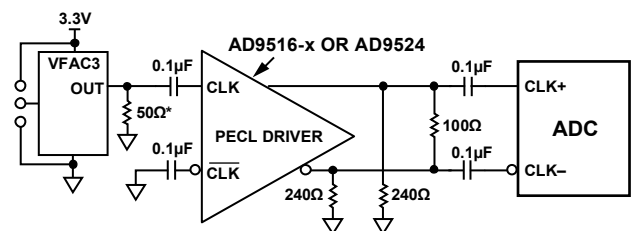

Figure 39. Transformer-Coupled Differential Clock

If a low jitter clock is available, another option is to ac couple a differential positive emitter-coupled logic (PECL) signal to the sample clock input pins, as shown in Figure 40. Analog Devices, Inc., offers a family of clock drivers with excellent jitter performance, including the AD9516-0, AD9516-1, AD9516-2, AD9516-3, and AD9516-5 (these five devices are represented by AD9516-x in Figure 40, Figure 41, and Figure 42), as well as the AD9524.



\*50Ω RESISTOR IS OPTIONAL.

Figure 40. Differential PECL Sample Clock

## AD9671

## Data Sheet

A third option is to ac couple a differential LVDS signal to the sample clock input pins, as shown in Figure 41.

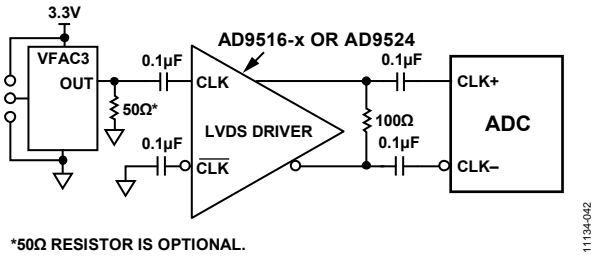

\*50Ω RESISTOR IS OPTIONAL.

Figure 41. Differential LVDS Sample Clock

In some applications, it is acceptable to drive the sample clock inputs with a single-ended CMOS signal. In such applications, drive CLK+ directly from a CMOS gate, and bypass the CLK- pin to ground with a 0.1 µF capacitor (see Figure 42).

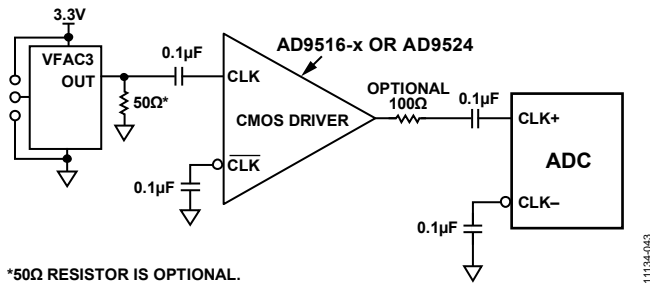

\*50Ω RESISTOR IS OPTIONAL.

Figure 42. Single-Ended 1.8 V CMOS Sample Clock

### Clock Duty Cycle Considerations

Typical high speed ADCs use both clock edges to generate a variety of internal timing signals. As a result, these ADCs can be sensitive to the clock duty cycle. Commonly, a 5% tolerance is required on the clock duty cycle to maintain dynamic performance characteristics. The AD9671 contains a duty cycle stabilizer (DCS) that retimes the nonsampling edge, providing an internal clock signal with a nominal 50% duty cycle. This DCS allows a wide range of clock input duty cycles without affecting the performance of the AD9671. When the DCS is on, noise and distortion performance are nearly flat for a wide range of duty cycles. However, some applications may require the DCS function to be off. When the DCS function is off, the dynamic range performance can be affected.

The duty cycle stabilizer uses a delay-locked loop (DLL) to create the nonsampling edge. As a result, any changes to the sampling frequency require approximately eight clock cycles to allow the DLL to acquire and lock to the new rate.

### Clock Jitter Considerations

High speed, high resolution ADCs are sensitive to the quality of the clock input. Calculate the degradation in SNR at a given input frequency ( $f_A$ ) due only to aperture jitter ( $t_j$ ) as follows:

$$\text{SNR Degradation} = 20 \times \log_{10}(1/2 \times \pi \times f_A \times t_j) \quad (7)$$

In this equation, the rms aperture jitter represents the root mean square of all jitter sources, including the clock input, analog input signal, and ADC aperture jitter (see Figure 43).

Treat the clock input as an analog signal in cases where aperture jitter may affect the dynamic range of the AD9671. Separate power supplies for clock drivers from the ADC output driver supplies to avoid modulating the clock signal with digital noise. Low jitter, crystal controlled oscillators make the best clock sources, such as the Valpey Fisher VFAC3 series. If the clock is generated from another type of source (by gating, dividing, or other methods), it is retimed by the original clock during the last step.

For more information on how jitter performance relates to ADCs, refer to the AN-501 Application Note and the AN-756 Application Note.

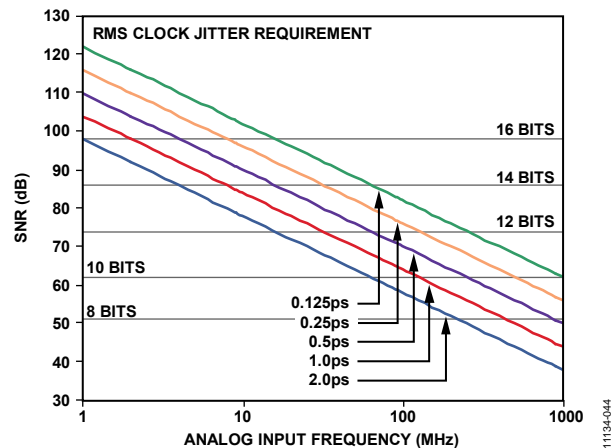

Figure 43. Ideal SNR vs. Input Frequency and Jitter

### Power Dissipation and Power-Down Mode

The power dissipated by the AD9671 is proportional to its sample rate. The digital power dissipation does not vary significantly because it is determined primarily by the DRVDD supply and the bias current of the LVDS output drivers. The AD9671 features scalable LNA bias currents (see Table 33, Address 0x012). The default LNA bias current settings are midhigh.

By asserting the PDWN pin high, the AD9671 is placed into power-down mode. In this state, the device typically dissipates 5 mW. During power-down, the LVDS output drivers are placed into a high impedance state. The AD9671 returns to normal operating mode when the PDWN pin is pulled low. This pin is only 1.8 V tolerant. To drive the PDWN pin from a 3.3 V logic level, insert a 1 kΩ resistor in series with this pin to limit the current.

By asserting the STBY pin high, the AD9671 is placed in standby mode. In this state, the device typically dissipates 725 mW. During standby, the entire device is powered down except the internal references. The LVDS output drivers are placed into a high impedance state. This mode is well suited for applications that require power savings because it allows the device to be powered down when not in use and then quickly powers up. The time to power up the device is also greatly reduced. The AD9671 returns to normal operating mode when the STBY pin is pulled low. This pin is only 1.8 V tolerant. To

drive the STBY pin from a 3.3 V logic level, insert a 1 k $\Omega$  resistor in series with this pin to limit the current.

In power-down mode, low power dissipation is achieved by shutting down the reference, reference buffer, PLL, and biasing networks. The decoupling capacitors on VREF are discharged when entering power-down mode and must be recharged when returning to normal operation. As a result, the wake-up time is related to the time spent in power-down mode: shorter cycles result in proportionally shorter wake-up times. To restore the device to full operation, approximately 375  $\mu$ s is required when using the recommended 1  $\mu$ F and 0.1  $\mu$ F decoupling capacitors on the VREF pin and the 0.01  $\mu$ F decoupling capacitors on the GAIN $\pm$  pins. Most of this time is dependent on gain decoupling; higher value decoupling capacitors on the GAIN $\pm$  pins result in longer wake-up times.

A number of other power-down options are available when using the SPI port interface. The user can individually power down each channel or place the entire device into standby mode. When fast wake-up times are required, standby mode allows the user to keep the internal PLL powered up. The wake-up time is slightly dependent on gain. To achieve a 2  $\mu$ s wake-up time when the device is in standby mode, apply 0.8 V to the GAIN $\pm$  pins.

#### Power and Ground Connection Recommendations

When connecting power to the AD9671, use two separate 1.8 V supplies: one for analog (AVDD1) and one for digital (DRVDD). If only one 1.8 V supply is available, route it to the AVDD1 pin first and then tap it off and isolate it with a ferrite bead or a filter choke preceded by decoupling capacitors for the DRVDD pin.

If the user does not use the digital demodulator/decimator functions for post ADC processing, the DVDD pin can be tied to the 1.8 V DRVDD supply. When this is done, route the DVDD supply first, tap it off, and isolate it with a ferrite bead or filter choke preceded by decoupling capacitors for the DRVDD pin. It is not recommended to use the same supply for AVDD1, DVDD, and DRVDD.

For both high and low frequencies, use several decoupling capacitors on all supplies. Place these capacitors near the point of entry at the PCB level and near the device, with minimal trace lengths.

When using the AD9671, a single PCB ground plane is sufficient. With proper decoupling and smart partitioning of the analog, digital, and clock sections of the PCB, optimum performance can be easily achieved.

#### Advanced Power Control

For an ultrasound system, not all channels are needed during all scanning periods. The POWER\_START and POWER\_STOP values in the vector profile can be used to delay the channel

startup and turn the channel off after a certain number of samples. These counters are relative to TX\_TRIG $\pm$ . The analog circuitry needs to power up before the digital one and the advance time (POWER\_SETUP) for powering up the analog circuitry, before POWER\_START, is set up in Address 0x112 (see Table 33).

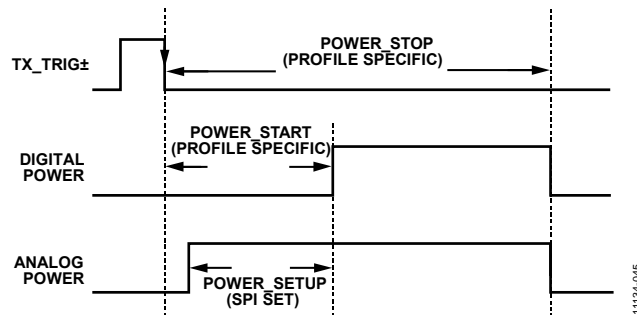

Figure 44. Power Sequencing

## DIGITAL OUTPUTS AND TIMING

### JESD204B Transmit Top Level Description

The AD9671 digital output complies with the JEDEC Standard JESD204B, *Serial Interface for Data Converters*. JESD204B is a protocol to link the AD9671 to a digital processing device over a serial interface up to 5 Gbps link speeds. The benefits of the JESD204B interface include a reduction in required board area for data interface routing, and enables smaller packages for converter and logic devices. The AD9671 supports single, dual, or quad lane interfaces.

### JESD204B Overview

The JESD204B data transmit block, as shown in Figure 45, assembles the parallel channel data from the ADC or digital processing block into frames and uses 8B/10B encoding as well as optional scrambling to form serial output data. Lane synchronization is supported through the use of special characters during the initial establishment of the link, and additional synchronization is embedded in the data stream thereafter. A matching external receiver is required to lock onto the serial data stream and recover the data and clock. For additional details on the JESD204B interface, users are encouraged to refer to the JESD204B standard.

The AD9671 JESD204B transmit block maps the eight channel outputs over a link. A link can be configured to use either single, dual, or quad serial differential outputs, which are called lanes. The JESD204B specification refers to a number of parameters to define the link, and these parameters must match between the JESD204B transmitter (AD9671 output) and receiver.

The JESD204B link is described according to the parameters listed in Table 14.

Table 14. JESD204B Parameters

Parameter	Description	AD9671 Value
S	Samples transmitted per single converter per frame cycle	1
M	Number of converters per converter device	8 with demodulator/decimator disabled, 16 with demodulator/decimator enabled
L	Number of lanes per converter device	1, 2, or 4
N	Converter resolution	12, 14, or 16
N'	Total number of bits per sample	16
CF	Number of control words per frame clock cycle per converter device	0
CS	Number of control bits per conversion sample	0
K	Number of frames per multiframe	Configurable on the <a href="#">AD9671</a>
HD	High density mode	0
F	Octets per frame	4, 8, 16, or 32 (dependent on L = 4, 2, or 1, respectively)
C	Control bit	0
T	Tail bit	Available on the <a href="#">AD9671</a>
SCR	Scrambler enable/disable	Configurable on the <a href="#">AD9671</a>
FCHK	Checksum for the JESD204B parameters	Automatically calculated and stored in the register map

Figure 45. [AD9671](#) Transmit Link Simplified Block Diagram

Figure 45 shows a simplified block diagram of the [AD9671](#) JESD204B link. By default, the [AD9671](#) is configured to use eight channels and four lanes. Channel A and Channel B data is output to SERDOUT1±, Channel C and Channel D data is output to SERDOUT2±, Channel E and Channel F data is output to SERDOUT3±, and Channel G and Channel H data is output to SERDOUT4±. The [AD9671](#) allows other configurations such as combining the outputs of the eight channels onto a single lane.

By default in the [AD9671](#), the 14-bit converter word from each converter is broken into two octets (eight bits of data). Bit 0 (MSB) through Bit 7 are in the first octet. The second octet contains Bit 8 through Bit 13 (LSB) and two tail bits. The tail bits can be configured as zeros or a pseudorandom number sequence.

The two resulting octets can be scrambled. Scrambling is optional but is available to avoid spectral peaks when transmitting similar digital data patterns. The scrambler uses a self synchronizing polynomial-based algorithm defined by the equation:  $1 + x^{14} + x^{15}$ . The descrambler in the receiver must be a self synchronizing version of the scrambler polynomial.

The two octets are then encoded with an 8B/10B encoder. The 8B/10B encoder works by taking eight bits of data (an octet) and encoding them into a 10-bit symbol. Figure 46 shows how the 14-bit data is taken from the ADC, the tail bits are added, the two octets are scrambled, and how the octets are encoded into two 10-bit symbols. Figure 46 illustrates the default data format.

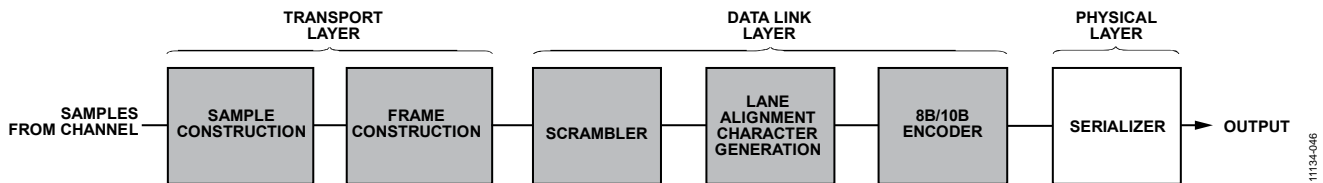
At the data link layer, in addition to the 8B/10B encoding, the character replacement allows the receiver to monitor frame alignment. The character replacement process occurs on the frame and multiframe boundaries, and implementation depends on which boundary is occurring and if scrambling is enabled.

If scrambling is disabled, the following applies. If the last scrambled octet of the last frame of the multiframe equals the last octet of the previous frame, the transmitter replaces the last octet with the control character /A/ = /K28.3/. On other frames within the multiframe, if the last octet in the frame equals the last octet of the previous frame, the transmitter replaces the last octet with the control character /F/ = /K28.7/.

If scrambling is enabled, the following applies. If the last octet of the last frame of the multiframe equals 0x7C, the transmitter replaces the last octet with the control character /A/ = /K28.3/. On other frames within the multiframe, if the last octet equals 0xFC, the transmitter replaces the last octet with the control character /F/ = /K28.7/.

Refer to JEDEC Standard JESD204B (July 2011) for additional information about the JESD204B interface. Section 5.1 describes the transport layer and data format details, and Section 5.2 describes scrambling and descrambling.

**JESD204B Synchronization Details**

The AD9671 is a JESD204B Subclass 0 device and establishes synchronization of the link through three control signals, TX\_TRIG, SYSREF, and SYNCINB, and typically a common device clock. SYSREF, TX\_TRIG, and SYNCINB are assumed to be common to all converter devices for alignment purposes at the system level.

The synchronization process is accomplished over three phases: code group synchronization (CGS) phase, initial lane alignment sequence (ILAS) phase, and data transmission phase. Note that if scrambling is enabled, the bits are not actually scrambled until the data transmission phase. The CGS and ILAS phases do not use scrambling.

**CGS Phase**

In this phase, the JESD204B transmit block transmits /K28.5/ characters in response to a synchronization request from the receiver (SYNCINB asserted). The receiver (external logic device) must locate K28.5 characters in its input data stream using clock and data recovery (CDR) techniques.

After a certain number of consecutive K28.5 characters are detected on all link lanes, the receiver can optionally initiate a SYS\_REF edge so that the AD9671 transmit data establishes a local multiframe clock (LMFC) internally. The AD9671 is a Subclass 0 device that does not mandate SYS\_REF for multi-device synchronization. The use of SYS\_REF reduces the latency variation between devices and reduces the absolute latency of each device to some extent. However, SYS\_REF does not meet the full requirements of a JESD204B Subclass 1 device, and the primary synchronization tool on the AD9671 is to use the global TX\_TRIG signal to embed a START\_CODE simultaneously into the data stream for all devices.

After synchronizing all lanes, the receiver or logic device deasserts the SYNCINB signal (SYNCINB± goes high), and the transmitter block begins the ILAS phase, if enabled, on the next internal LMFC boundary.

**ILAS Phase**

In the ILAS phase, the transmitter sends out a known pattern and the receiver aligns all lanes of the link and verifies the parameters of the link.

The ILAS phase begins after SYNCINB± is deasserted (goes high). The transmit block begins to transmit four multiframe. Dummy samples are inserted between the required characters so that full multiframe are transmitted.

The four multiframe have the following properties:

- Multiframe 1 begins with an /R/ character (K28.0) and ends with an /A/ character (K28.3).
- Multiframe 2 begins with an /R/ character, followed by a /Q/ (K28.4) character and link configuration parameters over 14 configuration octets (see Table 15), and ends with an /A/ character. Many of the parameter values are of the notation of the value – 1.
- Multiframe 3 is the same as Multiframe 1.
- Multiframe 4 is the same as Multiframe 1.

**Data Transmission Phase**

By the end of the ILAS phase, data transmission starts. Initiating a global TX\_TRIG signal resets any sampling edges within the ADC and replaces a sample with the START\_CODE (see Address 0x18B and Address 0x18C in Table 33). Aligning the data on all lanes based on the START\_CODE guarantees the synchronization across multiple lanes and across multiple devices.

In the data transmission phase, frame alignment is monitored with control characters. Character replacement is used at the end of frames. Character replacement in the transmitter occurs in the following instances:

- If scrambling is disabled and the last octet of the frame or multiframe equals the octet value of the previous frame.
- If scrambling is enabled and the last octet of the multiframe is equal to 0x7C, or the last octet of a frame is equal to 0xFC.

**Table 15. 14 Configuration Octets of the ILAS Phase**

No.	Bit 7 (MSB)	Bit 6	Bit 5	Bit 4	Bit 3	Bit 2	Bit 1	Bit 0 (LSB)
0	DID[7:0]							
1	0	0	0	0	BID[3:0]			
2	0	0	0	LID[4:0]				
3	SCR	0	0	L[4:0]				
4	F[7:0]							
5	0	0	0	K[4:0]				
6	M[7:0]							
7	CS[1:0]		0	N[4:0]				
8	0	0	0	N'[4:0]				
9	0	0	0	S[4:0]				
10	HD	0	0	CF[4:0]				
11	Reserved, don't care							
12	Reserved, don't care							
13	FCHK[7:0]							

### Link Setup Parameters

The following steps demonstrate how to configure the AD9671 JESD204B interface and the outputs.

1. Disable lanes before changing the configuration.
2. Select the converter and lane configuration.
3. Configure the tail bits and control bits.
4. Set the lane identification values.
5. Set the number of frame per multiframe, K.
6. Enable scramble, SCR.
7. Set the lane synchronization options.
8. Verify FCHK, checksum of JESD204B interface parameters.
9. Set additional digital output configuration options.
10. Reenable lane(s) after configuration.

### Disable Lanes

Before modifying the JESD204B link parameters, disable the link and hold it in reset. This is accomplished by writing a Logic 1 to Address 0x142, Bit 0.

### Converter and Lane Configuration

If the digital demodulator/decimator is disabled, the JESD204B M parameter (number of converters) is set to 8 (Address 0x153 = 0x07). Otherwise M = 16 when the channel output is complex data.

The lane configuration is set in Address 0x150, Bits[1:0] such that 00 = one lane per link, 01 = two lanes per link, or 11 = four lanes per link. The channel data (A to H) is placed on the JESD204B lanes according Table 16.

**Table 16. Channel to JESD204B Lane Mapping**

L	SERDOUT1±	SERDOUT2±	SERDOUT3±	SERDOUT4±
1	A, B, C, D, E, F, G, H	Power-down	Power-down	Power-down
2	A, B, C, D	Power-down	E, F, G, H	Power-down
4	A, B	C, D	E, F	G, H

### Configure the Tail Bits and Control Bits

With  $N' = 16$  and  $N = 14$ , two tail bits are available per sample for transmitting additional information over the JESD204B link. Tail bits are dummy bits sent over the link to complete the two octets and do not convey any information about the input signal. Tail bits can be fixed zeros (default) or pseudorandom numbers (Address 0x142, Bit 6).

### Set Lane Identification Values

JESD204B allows parameters to identify the device and lane. These parameters are transmitted during the ILAS phase, and they are accessible in the internal registers.

There are three identification values: device identification (DID), bank identification (BID), and lane identification (LID). DID and BID are device specific; therefore, they can be used for link identification.

**Table 17. JESD204B Configurable Identification Values**

DID Value	Register, Bits	Value Range
LID (SERDOUT1±)	0x148, [4:0]	0 to 31
LID (SERDOUT2±)	0x149, [4:0]	0 to 31
LID (SERDOUT3±)	0x14A, [4:0]	0 to 31
LID (SERDOUT4±)	0x14B, [4:0]	0 to 31
DID	0x146, [7:0]	0 to 255
BID	0x147, [3:0]	0 to 15

### Set Number of Frames per Multiframe, K

Per the JESD204B specification, a multiframe is defined as a group of K successive frames, where K is between 1 and 32, and it requires that the number of octets be between 17 and 1024. The K value is set to 32 by default in Register 0x152, Bits[4:0]. Note that Register 0x152 represents a value of  $K - 1$ .

The K value can be changed; however, it must comply with a few conditions. The AD9671 uses a fixed value for octets per frame, F. K must also be a multiple of 4 and conform to the following equation:

$$32 \geq K \geq \text{Ceil}(17/F)$$

The JESD204B specification also requires that the number of octets per multiframe ( $K \times F$ ) be between 17 and 1024. The F value is fixed based on the value of M and L. F can be read from Address 0x151.

$$F = \frac{M \times 2}{L}$$

### Enable Scramble, SCR

Scrambling can be enabled or disabled by setting Address 0x150, Bit 7. By default, scrambling is enabled. Per the JESD204B protocol, scrambling is only functional after the lane synchronization is complete.

### Set Lane Synchronization Options

Most of the synchronization features of the JESD204B interface are enabled by default for typical applications. In some cases, these features can be disabled or modified as follows.

ILAS enabling is controlled in Address 0x142, Bits[3:2] and is enabled by default. Optionally, to support some unique instances of the interfaces (such as NMCDA-SL), the JESD204B interface can be programmed to either disable the ILAS sequence or continually repeat the ILAS sequence. Additionally, the ILAS can be repeated for a fixed count, as programmed in Address 0x145, Bits[7:0].

The AD9671 has fixed values of some of the JESD204B interface parameters, and they are as follows:

- $N' = 16$ : number of bits per sample is 16. Read only value from Address 0x155, Bits[3:0] = 15 ( $N' - 1$ ).
- $CF = 0$ : number of control words per frame clock cycle per converter is 0, in Address 0x157, Bits[4:0].

The AD9671 calculates values for some JESD204B parameters based on other settings, particularly the quick configuration register selection. The following read only values are available in the register map for verification:

- F: octets per frame can be 32, 16, 8, or 4; read the value (F – 1) from Address 0x151, Bits[4:0]
- M: number of converters per link can be 8 or 16; read the value (M – 1) from Address 0x153, Bits[3:0]
- S: samples per converter per frame is 1 by default; read the value (S – 1) from Address 0x156, Bit 0.

**Verify FCHK, Checksum of JESD204B Interface Parameters**

The JESD204B parameters can be verified through a checksum value (FCHK) of the JESD204B interface parameters. Each lane has a FCHK value associated with it. The FCHK value is transmitted during the ILAS second multiframe and can be read from the internal registers.

Checksum value is the modulo 256 sum of the parameters listed as Octet 0 to Octet 10 in Table 18. Checksum is calculated by adding the parameter fields before they are packed into the octets.

The FCHK value for the lane configuration for data coming out of SERDOUT1± can be read from Address 0x15A. Similarly, FCHK for the lane defined for SERDOUT2± can be read from Address 0x15B.

**Table 18. JESD204B Configuration Table Used in ILAS and Checksum Calculation**

No.	Bit 7 (MSB)	Bit 6	Bit 5	Bit 4	Bit 3	Bit 2	Bit 1	Bit 0 (LSB)
0	DID[7:0]							
1								BID[3:0]
2								LID[4:0]
3	SCR							L[4:0]
4	F[7:0]							
5								K[4:0]
6	M[7:0]							
7	CS[1:0]					N[4:0]		
8								N'[4:0]
9								S[4:0]
10								CF[4:0]

**Set Additional Digital Output Configuration Options**

The JESD204B outputs are configured by default to produce a peak differential voltage of 262 mV. This voltage satisfies the JESD204B specification for a transmit eye mask for an LV-OIF-11G-SR-based operation target of between 180 mV and 385 mV peak differential voltage, but other peak differential voltages can be accommodated. Address 0x015, Bits[6:4] settings allow output peak voltages. Additional options include the following:

- Invert polarity of the serial output data: Address 0x014, Bit 2
- Flip (mirror) 10-bit word before output: Address 0x143, Bit 0
- Channel data format (offset binary, twos complement, gray code): Address 0x014, Bits[1:0]
- Options for interpreting the signal on the SYNCINB± pin: Address 0x156, Bit 5

**Reenable Lanes After Configuration**

After modifying the JESD204B link parameters, enable the link and then the synchronization process can begin. This enable is accomplished by writing a Logic 0 to Address 0x142, Bit 0.

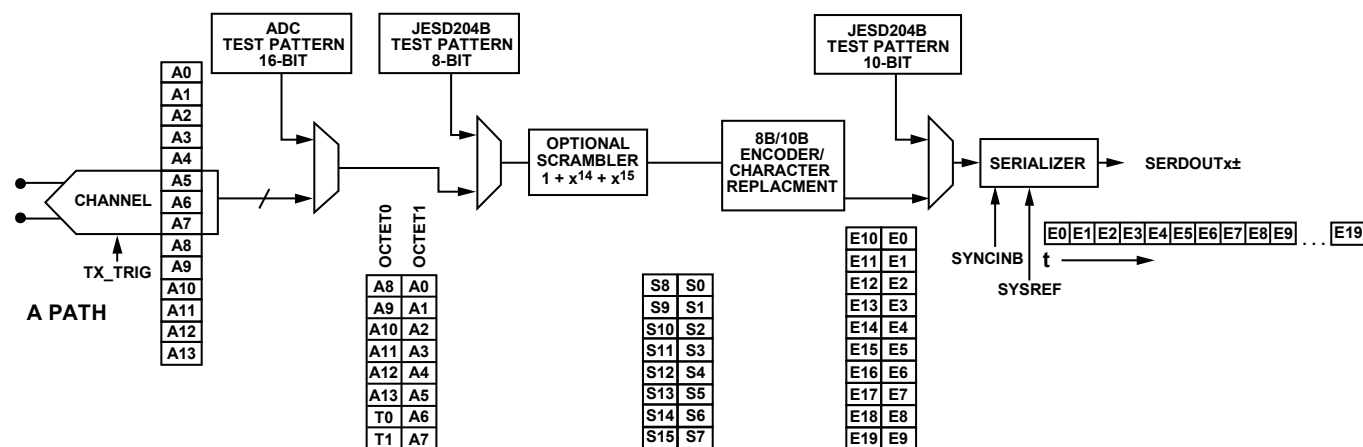

Figure 46. AD9671 Digital Processing of JESD204B Lanes

11134-047

Table 19. AD9671 JESD204B Frame Alignment Monitoring and Correction Replacement Characters

Scrambling	Lane Synchronization	Character to be Replaced	Last Octet in Multiframe	Replacement Character
Off	On	Last octet in frame repeated from previous frame	No	K28.7
Off	On	Last octet in frame repeated from previous frame	Yes	K28.3
Off	Off	Last octet in frame repeated from previous frame	Not applicable	K28.7
On	On	Last octet in frame equals D28.7	No	K28.7
On	On	Last octet in frame equals D28.3	Yes	K28.3
On	Off	Last octet in frame equals D28.7	Not applicable	K28.7

### Frame and Lane Alignment Monitoring and Correction

Frame alignment monitoring and correction is part of the JESD204B specification. The 14-bit word requires two octets to transmit all the data. The two octets (MSB and LSB), where  $F = 2$ , make up a frame. During normal operating conditions frame alignment is monitored via alignment characters that are inserted under certain conditions at the end of a frame. Table 19 summarizes the conditions for character insertion along with the expected characters under the various operation modes. If lane synchronization is enabled, the replacement character value depends on whether the octet is at the end of a frame or at the end of a multiframe.

Based on the operating mode, the receiver can ensure that it is still synchronized to the frame boundary by correctly receiving the replacement characters.

### Super Frame and Output Zero Stuffing

To handle the various decimation rates and to handle complex (IQ) vs. real samples, a wrapper around the JESD204B transmitter was created. Each word in the standard JESD204B frame represents a word in the super frame. However, in most cases, the frame boundary for the super-frame does not occur at the same time as the JESD204B frame boundary.

As the decimation rates increase, relatively large amounts of zero stuffing can occur. The zero stuffer can be configured to add additional codes into the data stream to facilitate super frame synchronization.

It is highly recommended to configure the device to auto-calculate the size of the JESD204B and the super frames.

### Digital Outputs and Timing

The AD9671 has differential digital outputs that power up by default. The driver current is derived on chip and sets the output current at each output equal to a nominal 3 mA. Each output presents a 100  $\Omega$  dynamic internal termination to reduce unwanted reflections.

The AD9671 digital outputs can interface with custom ASICs and FPGA receivers, providing superior switching performance in noisy environments. Single point-to-point network topologies are recommended with a single differential 100  $\Omega$  termination resistor placed as close to the receiver logic as possible.

For receiver inputs that provide their own common-mode bias, or whose input common-mode requirements are not within the bounds of the AD9671 DRVDD supply, use an ac-coupled

connection as shown in Figure 47. Place a 0.1  $\mu\text{F}$  series capacitor on each output pin and use a 100  $\Omega$  differential termination close to the receiver side. The 100  $\Omega$  differential termination results in a nominal 600 mV p-p differential swing at the receiver. In the case where the receiver inputs do not provide their own common-mode bias, single-ended 50  $\Omega$  terminations can be used. When single-ended terminations are used, the termination voltage ( $V_{\text{RXCM}}$ ) must be chosen to match the input requirements of the receiver.

For receivers whose input common-mode voltage requirements match the output common-mode voltage ( $\text{DRVDD}/2$ ) of the AD9671, a dc-coupled connection can be used. The common mode of the digital output automatically biases itself to half of DRVDD (0.9 V for  $\text{DRVDD} = 1.8 \text{ V}$ ) (see Figure 48).

If there is no far end receiver termination or if there is poor differential trace routing, timing errors may result. To avoid such timing errors, it is recommended that the trace length be less than six inches and that the differential output traces be adjacent and at equal lengths.

Figure 49 through Figure 54 show examples of the digital output (default) data eyes, time interval error (TIE) jitter histograms, and bathtub curves.

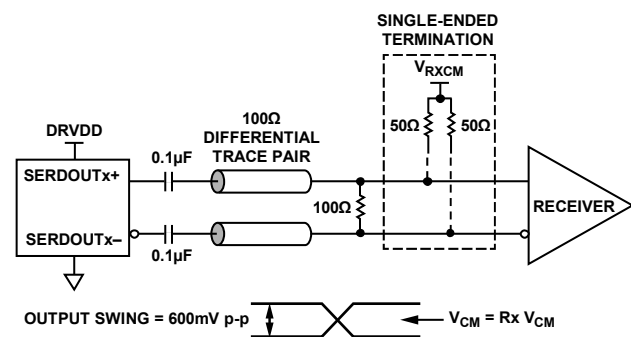

Figure 47. AC-Coupled Digital Output Termination Example

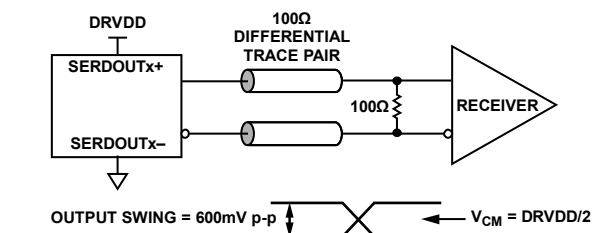

Figure 48. DC-Coupled Digital Output Termination Example

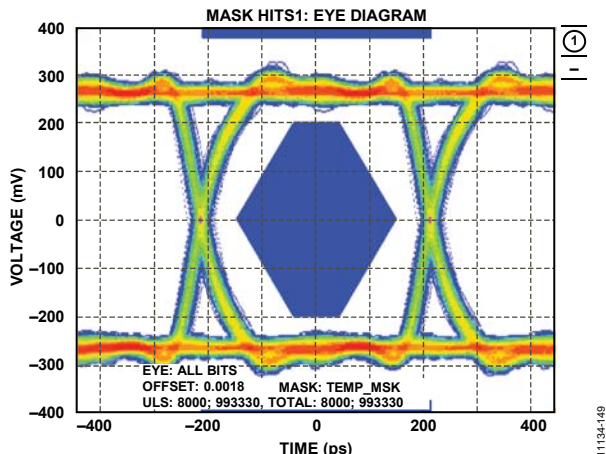

Figure 49. Digital Outputs Data Eye, External 100 Ω Terminations at 2.5 Gbps

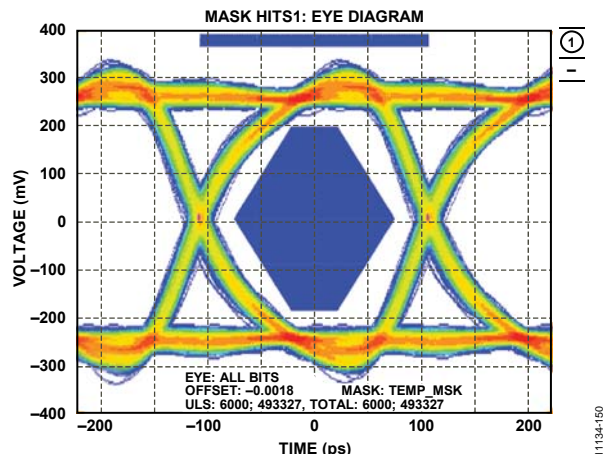

Figure 52. Digital Outputs Data Eye, External 100 Ω Terminations at 5.0 Gbps

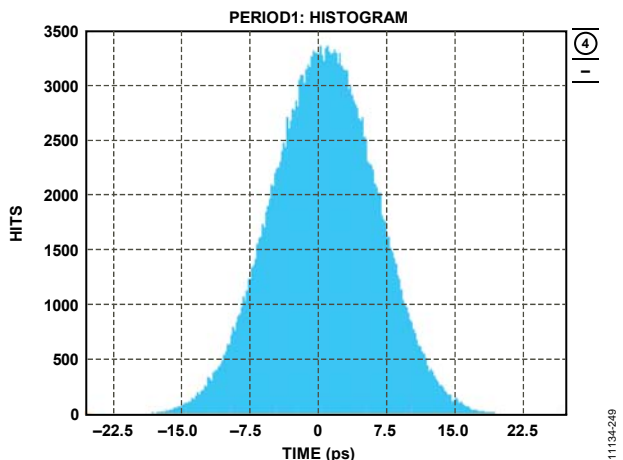

Figure 50. Digital Outputs Histogram, External 100 Ω Terminations at 2.5 Gbps

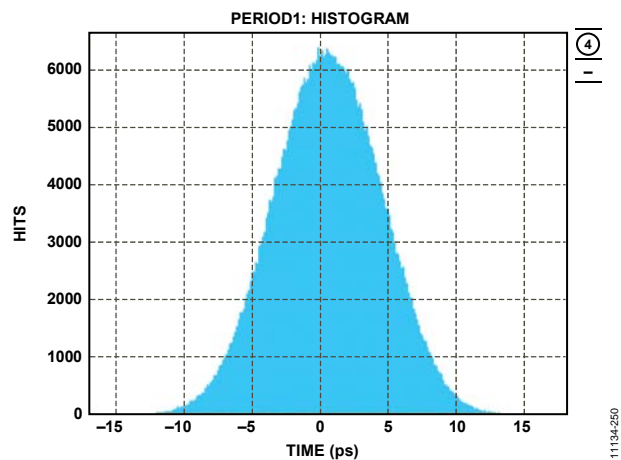

Figure 53. Digital Outputs Histogram, External 100 Ω Terminations at 5.0 Gbps

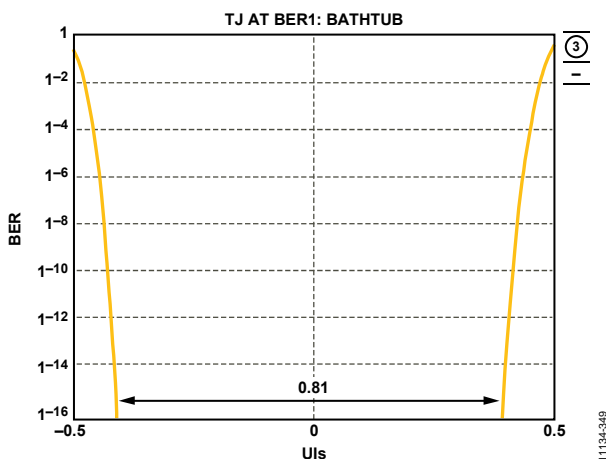

Figure 51. Digital Outputs Bathtub, External 100 Ω Terminations at 2.5 Gbps

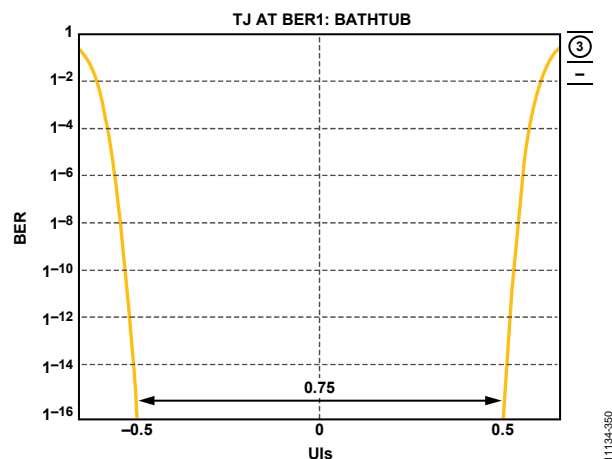

Figure 54. Digital Outputs Bathtub, External 100 Ω Terminations at 5.0 Gbps

Additional SPI options allow the user to further increase the output driver voltage swing of all four outputs to drive longer trace lengths (see Address 0x015 in Table 33). Even though this produces sharper rise and fall times on the data edges and is less prone to bit errors, the power dissipation of the DRVDD supply increases when this option is used. See the Memory Map section for more details.

### Preemphasis

Preemphasis enables the receiver eye diagram mask to be met in conditions where the interconnect insertion loss is not in accordance with the JESD204B specification. In conditions where pre-emphasis is not needed to achieve sufficient signal integrity for the link, it is best to disable the preemphasis to conserve power. Enabling preemphasis on a short link and increasing the de-emphasis value too high may cause the receiver eye diagram to fail in cases where it passes with no de-emphasis. The transmitter eye diagram does not necessarily pass when preemphasis is enabled. Furthermore, using more preemphasis than necessary may increase EMI; therefore, consider EMI when choosing an insertion loss compensation strategy. To enable preemphasis, write a Logic 1 to Address 0x015, Bit 1.

There are several methods to select test data patterns on the JESD204B link, as shown in Figure 55. These methods serve different purposes in the testing process of establishing the link.

The processed samples from the ADC can be replaced by nine digital output test pattern options. The replacement is initiated through the SPI using Address 0x00D, Bits[3:0]. These options are useful when validating receiver capture and timing. See Table 21 for the output test mode bit sequencing options. Some test patterns have two serial sequential words, which the user can alternate in various ways, depending on the test pattern chosen. Note that some patterns may not adhere to the data format select option. In addition, custom user defined test

patterns are assigned in the user pattern registers (Address 0x019 through Address 0x020). All test mode options except PN sequence short and PN sequence long can support 8-bit to 14-bit word lengths to verify data capture to the receiver.

The PN sequence short pattern produces a pseudorandom bit sequence that repeats itself every  $2^9 - 1$  bits, or 511 bits. For a description of the PN sequence short pattern and how it is generated, see Section 5.1 of the ITU-T O.150 (05/96) standard. The only difference from the standard is that the starting value is a specific value instead of all 1s (see Table 20 for the initial values).

The PN sequence long pattern produces a pseudorandom bit sequence that repeats itself every  $2^{23} - 1$  bits, or 8,388,607 bits. For a description of the PN sequence long pattern and how it is generated, see Section 5.6 of the ITU-T O.150 (05/96) standard. The only differences from the standard are that the starting value is a specific value instead of all 1s and that the AD9671 inverts the bit stream (see Table 20 for the initial values). The output sample size depends on the selected bit length.

**Table 20. PN Sequence Initial Values**

Sequence	Initial Value	First Three Output Samples (MSB First, 16-Bit)
PN Sequence Short	0x092	0x496F, 0xC9A9, 0x980C
PN Sequence Long	0x003	0xFF5C, 0x0029, 0xB80A

See the Memory Map section for information on how to change these additional digital output timing features through the SPI.

Test patterns are initiated at the input of the scrambler block by setting Address 0x144, Bits[5:4] = 10 or at the output of the 8B/10B encoder by setting Address 0x144, Bits[5:4] = 01. The test pattern generated is selected in Address 0x144, Bits[3:0], and is specified in Table 22.

**Digital Output Test Patterns**

Figure 55. Example of Data Flow Block Diagram

11134-052

**Table 21. Flexible Output Test Modes—Address 0x00D**

Output Test Mode Bit Sequence	Pattern Name	Digital Output Word 1	Digital Output Word 2	Digital Output Word 3	Digital Output Word 4	Subject to Resolution Select
0000	Off (default)	Not applicable	Not applicable	Not applicable	Not applicable	Not applicable
0001	Midscale short	10 0000 0000 0000	Same	Same	Same	Yes
0010	+Full-scale short	11 1111 1111 1111	Same	Same	Same	Yes
0011	–Full-scale short	00 0000 0000 0000	Same	Same	Same	Yes
0100	Checkerboard output	10 1010 1010 1010	01 0101 0101 0101	10 1010 1010 1010	01 0101 0101 0101	No
0101	PN sequence long	Not applicable	Not applicable	Not applicable	Not applicable	Yes
0110	PN sequence short	Not applicable	Not applicable	Not applicable	Not applicable	Yes
0111	One-/zero-word toggle	11 1111 1111 1111	00 0000 0000 0000	11 1111 1111 1111	00 0000 0000 0000	No
1000	User input	Address 0x019 and Address 0x01A	Address 0x01B and Address 0x01C	Address 0x01D and Address 0x01E	Address 0x01F and Address 0x020	No
1001 to 1110	Reserved	Not applicable	Not applicable	Not applicable	Not applicable	No
1111	Ramp output	00 0000 0000 0000	00 0000 0000 0001	00 0000 0000 0000	00 0000 0000 0001	Yes

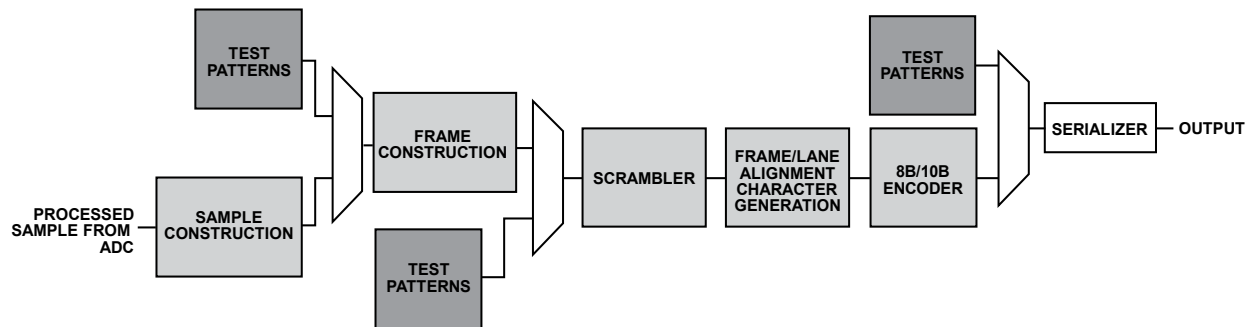
**Table 22. Flexible Output Test Modes—Address 0x144**

Output Test Mode Bit Sequence	Pattern Name	Digital Output Word 1	Digital Output Word 2	Digital Output Word 3	Digital Output Word 4	Subject to Resolution Select
0000	Off (default)	Not applicable	Not applicable	Not applicable	Not applicable	Not applicable
0001	Alternating checkerboard	10 1010 1010 1010	01 0101 0101 0101	10 1010 1010 1010	01 0101 0101 0101	No
0010	One-/zero-word toggle	11 1111 1111 1111	00 0000 0000 0000	11 1111 1111 1111	00 0000 0000 0000	No
0011	PN sequence long	Not applicable	Not applicable	Not applicable	Not applicable	Yes
0100	PN sequence short	Not applicable	Not applicable	Not applicable	Not applicable	Yes
0101	Continuous/repeat user test pattern	Address 0x019 and Address 0x01A	Address 0x01B and Address 0x01C	Address 0x01D and Address 0x01E	Address 0x01F and Address 0x020	No
0110	Single user test pattern	Address 0x019 and Address 0x01A	Address 0x01B and Address 0x01C	Address 0x01D and Address 0x01E	Address 0x01F and Address 0x020	No
0111	Ramp output	00 0000 0000 0000	00 0000 0000 0001	00 0000 0000 0000	00 0000 0000 0001	Yes
1000	Modified RPAT sequence	See JESD204B specification	See JESD204B specification	See JESD204B specification	See JESD204B specification	Not applicable
1001 to 1111	Reserved	Not applicable	Not applicable			No

# AD9671

# Data Sheet

## SDIO Pin

The SDIO pin is required to operate the SPI. The SDIO pin has an internal 30 k $\Omega$  pull-down resistor that pulls it low and is only 1.8 V tolerant. To drive the SDIO pin from a 3.3 V logic level, insert a 1 k $\Omega$  resistor in series with this pin to limit the current.

## SCLK Pin

The SCLK pin is required to operate the SPI. The SCLK pin has an internal 30 k $\Omega$  pull-down resistor that pulls it low and is only 1.8 V tolerant. To drive the SCLK pin from a 3.3 V logic level, insert a 1 k $\Omega$  resistor in series with this pin to limit the current.

## CSB Pin

The CSB pin is required to operate the SPI. The CSB pin has an internal 70 k $\Omega$  pull-up resistor that pulls it high and is only 1.8 V tolerant. To drive the CSB pin from a 3.3 V logic level, insert a 1 k $\Omega$  resistor in series with this pin to limit the current.

## RBIAS Pin

To set the internal core bias current of the ADC, place a resistor nominally equal to 10.0 k $\Omega$  to ground at the RBIAS pin. Using a resistor other than the recommended 10.0 k $\Omega$  resistor for RBIAS degrades the performance of the device. Therefore, use at least a 1% tolerance on this resistor to achieve consistent performance.

## VREF Pin

A stable and accurate 0.5 V voltage reference is built into the AD9671. This voltage reference is amplified internally by a factor of 2, setting VREF to 1.0 V, which results in a full-scale differential input span of 2.0 V p-p for the ADC. VREF is set internally by default, but the user can drive the VREF pin externally with a 1.0 V reference to achieve more accuracy. However, the AD9671 does not support ADC full-scale ranges less than 2.0 V p-p.

When applying the decoupling capacitors to the VREF pin, use ceramic, low equivalent series resistance (ESR) capacitors. Ensure that these capacitors are near the reference pin and on the same layer of the PCB as the AD9671. The VREF pin must have both a 0.1  $\mu$ F capacitor and a 1  $\mu$ F capacitor that are connected in parallel to analog ground. These capacitor values are recommended for the ADC to properly settle and acquire the next valid sample.

## GPOx Pins

Use the general-purpose output pins, GPO0, GPO1, GPO2, and GPO3, in a system to provide programmable inputs to other chips in the system. The value of each pin is set via Address 0x00E to either Logic 0 or Logic 1 (see Table 33).

## ADDRx Pins

Use the chip address pins to address individual AD9671 devices in a system. Chip address mode is enabled using Address 0x115, Bit 5 (see Table 33). If the value written to Bits[4:0] matches the value on the chip address bit pins (ADDR4 to ADDR0), the device is selected and any subsequent SPI writes or reads to addresses indicated as chip registers are written only to that device. If chip address mode is disabled, write all addresses regardless of the value on the address pins.

## TX\_TRIG $\pm$ Pins

The TX\_TRIG $\pm$  function has several uses within the AD9671 and is initiated with an external hardware trigger either on the TX\_TRIG $\pm$  pins or by a software trigger by setting Address 0x10C, Bit 5 to 1. The hardware trigger has the advantage of guaranteed synchronous triggering of multiple AD9671 devices in a system. The setup and hold time for each TX\_TRIG $\pm$  hardware input is given in Table 3 as 1 ns. Due to the asynchronous SPI function, the software trigger cannot guarantee synchronization of multiple AD9671 devices. If the TX\_TRIG $\pm$  hardware trigger is not used, tie the TX\_TRIG $\pm$  pins in a low logic state.

The TX\_TRIG $\pm$  function is used to reset circuits in the digital demodulator and decimator (see the Baseband Demodulator and Decimator section), initiate the advanced power mode (see the Advanced Power Control section), and synchronize the data serialization in the JESD204B block (see the JESD204B Overview section).

## ANALOG TEST TONE GENERATION

The AD9671 can generate analog test tones that the user can then switch to the input of the LNA of each channel for channel gain calibration. The test tone amplitude at the LNA output is dependent on LNA gain, as shown in Table 23.

**Table 23. Test Signal Fundamental Amplitude at LNA Output**

Address 0x116[3:2], Analog Test Tones	LNA Gain 15.6 dB	LNA Gain 17.9 dB	LNA Gain 21.6 dB
00 (default)	80 mV p-p	98 mV p-p	119 mV p-p
01	160 mV p-p	196 mV p-p	238 mV p-p
10	320 mV p-p	391 mV p-p	476 mV p-p
11	Reserved	Reserved	Reserved

Calculate the test signal amplitude at the input to the ADC given the LNA gain, attenuator control voltage, and the PGA gain. Table 24 and Table 25 list example calculations.

**Table 24. Test Signal Fundamental Amplitude at ADC Input, V<sub>GAIN</sub> = 0 V, PGA Gain = 21 dB**

Address 0x116[3:2], Analog Test Tones	LNA Gain 15.6 dB	LNA Gain 17.9 dB	LNA Gain 21.6 dB
00 (default)	-29 dBFS	-28 dBFS	-26 dBFS
01	-23 dBFS	-22 dBFS	-20 dBFS
10	-17 dBFS	-16 dBFS	-14 dBFS
11	Reserved	Reserved	Reserved

**Table 25. Test Signal Fundamental Amplitude at ADC Input, V<sub>GAIN</sub> = 0 V, PGA Gain = 30 dB**

Address 0x116[3:2], Analog Test Tones	LNA Gain 15.6 dB	LNA Gain 17.9 dB	LNA Gain 21.6 dB
00 (default)	-20 dBFS	-19 dBFS	-17 dBFS
01	-14 dBFS	-13 dBFS	-11 dBFS
10	-8 dBFS	-7 dBFS	-5 dBFS
11	Reserved	Reserved	Reserved

## CW DOPPLER OPERATION

Each channel of the AD9671 includes an I/Q demodulator. Each demodulator has an individual programmable phase shifter. The I/Q demodulator is ideal for phased array beamforming applications in medical ultrasound. Each channel can be programmed for 16 phase settings/360° (or 22.5°/step), selectable via the SPI port. The device has a RESET± input that is used to synchronize the LO dividers of each channel. If multiple AD9671 devices are used, a common reset across the array ensures a synchronized phase for all channels. If the RESET± input is not used, tie each input pin to ground. Internal to the AD9671, the individual Channel I and Channel Q outputs are current summed. If multiple AD9671 devices are used, current sum and convert the I and Q outputs from each AD9671 to a voltage using an external transimpedance amplifier.

### Quadrature Generation

The internal 0° and 90° LO phases are digitally generated by a divide-by-M logic circuit, where M is 4, 8, or 16. The internal divider is selected via Address 0x02E, Bits[2:0] (see Table 33). The divider is dc-coupled and inherently broadband; the maximum LO frequency is limited only by its switching speed. Ensure that the duty cycle of the quadrature LO signals is as near 50% as possible for the 4LO and 8LO modes. The 16LO mode does not require a 50% duty cycle. Furthermore, the divider is implemented such that the MLO signal relocks the final flip-flops that generate the internal LO signals and thereby minimizes noise introduced by the divide circuitry.

For optimum performance, the MLO signal input is driven differentially, as on the AD9671 evaluation board. The common-mode voltage on each pin is approximately 1.2 V with the nominal 3 V supply. It is important to ensure that the MLO source have very low phase noise (jitter), a fast slew rate, and an adequate input level to obtain optimum performance of the CW signal chain.

Beamforming applications require a precise channel-to-channel phase relationship for coherence among multiple channels. The RESET± input is provided to synchronize the LO divider circuits in different AD9671 devices when they are used in arrays. The RESET± input is a synchronous edge-triggered input that resets the dividers to a known state after power is applied to multiple AD9671 devices. The RESET± signal can be either a continuous signal or a single pulse, and it can be either synchronized with the MLO± clock edge (recommended) or it can be asynchronous. If a

continuous signal is used for the RESET± then it has to be at the LO rate. For synchronous RESET±, the device can be configured to sample the RESET± signal with either the falling or rising edge of the MLO± clock, which makes it easier to align the RESET± signal with the opposite MLO± clock edge. Register 0x02E is used to configure the RESET signal behavior. Synchronize the RESET± input to the MLO signal input. Achieve accurate channel-to-channel phase matching via a common clock on the RESET± input when using more than one AD9671.

### I/Q Demodulator and Phase Shifter

The I/Q demodulators consist of double-balanced, harmonic rejection, passive mixers. The RF input signals are converted into currents by transconductance stages that have a maximum differential input signal capability of matching the LNA output full scale. These currents are then presented to the mixers that convert them to baseband (RF – LO) and 2× RF (RF + LO). The signals are phase shifted according to the codes that are programmed into the SPI latch (see Table 26). The phase shift function is an integral part of the overall circuit. The phase shift listed in Table 26 is defined as being between the baseband I or Q channel outputs. As an example, for a common signal applied to a pair of RF inputs to an AD9671, the baseband outputs are in phase for matching phase codes. However, if the phase code for Channel 1 is 0000 and the phase code for Channel 2 is 0001, Channel 2 leads Channel 1 by 22.5°.

**Table 26. Phase Select Code for Channel-to-Channel Phase Shift**

Phase Shift	I/Q Demodulator Phase (Address 0x02D[3:0])
0°	0000
22.5°	0001 (not valid for 4LO mode)
45°	0010
67.5°	0011 (not valid for 4LO mode)
90°	0100
112.5°	0101 (not valid for 4LO mode)
135°	0110
157.5°	0111 (not valid for 4LO mode)
180°	1000
202.5°	1001 (not valid for 4LO mode)
225°	1010
247.5°	1011 (not valid for 4LO mode)
270°	1100
292.5°	1101 (not valid for 4LO mode)
315°	1110
337.5°	1111 (not valid for 4LO mode)

## DIGITAL DEMODULATOR/DECIMATOR

The AD9671 contains digital processing capability. Each channel has three stages of processing that are available: RF decimator, baseband (BB) demodulator, and baseband decimator. For test purposes, the input to the demodulator/decimator can serve as a test waveform. Normally, the input is the output of the ADC. The output of the demodulator/decimator is sent to the framer/serializer for output formatting.

The maximum data rate of the BB demodulator and decimator is 65 MSPS. Therefore, if the sample of the ADC is greater than 65 MSPS, enable the RF decimator (fixed rate of 2). The ADC resolution is 14 bits. The maximum resolution at the output of the digital processing is 16 bits. Saturation of the ADC is determined after the dc offset calibration to ensure maximum dynamic range. Depending on decimation rate, the loss in output SNR due to truncation to 16 bits is negligible.

### VECTOR PROFILE

To minimize the time needed to reconfigure device settings during operation, the device supports configuration profiles. The user can store up to 32 profiles in the device. A profile is selected by a 5-bit index. A profile consists of a 64-bit vector, as described in Table 27. Each parameter is concatenated to form the 64-bit profile vector. The profile memory starts at Register 0xF00 and ends at Register 0xFFF. Write the memory in either stream or address selected data mode. However, the user must read the memory using stream mode. When writing or reading in

stream mode while the SPI configuration is set to MSB first mode (default setting for Register 0x000), the write/read address needs to refer to the last register address, not the first one. For example, when writing or reading the first profile that spans the address space between Register 0xF00 and Register 0xF07, with the SPI port configured as MSB first, the referenced address must be Register 0xF07 to allow reading or writing the 64 profile bits in MSB mode. For more information about stream mode, see the [AN-877 Application Note, Interfacing to High Speed ADCs via SPI](#).

There is a buffer used to store the current profile data. When the profile index is written in Register 0x10C, the selected profile is read from memory and stored in the current profile buffer. The profile memory is read/written in the SPI clock domain. After the SPI writes the profile index value, it takes four SPI clock cycles to read the profile from RAM and store it in the current profile buffer. If the SPI is in LSB mode, these additional SPI clock cycles are provided when the profile index register is written. If the SPI is in MSB mode, an additional byte must be read or written to update the profile buffer.

Updating profile memory does not affect the data in the profile buffer. The profile index register must be written to cause a refresh of the current profile data, even if the profile index register is written with the same value.

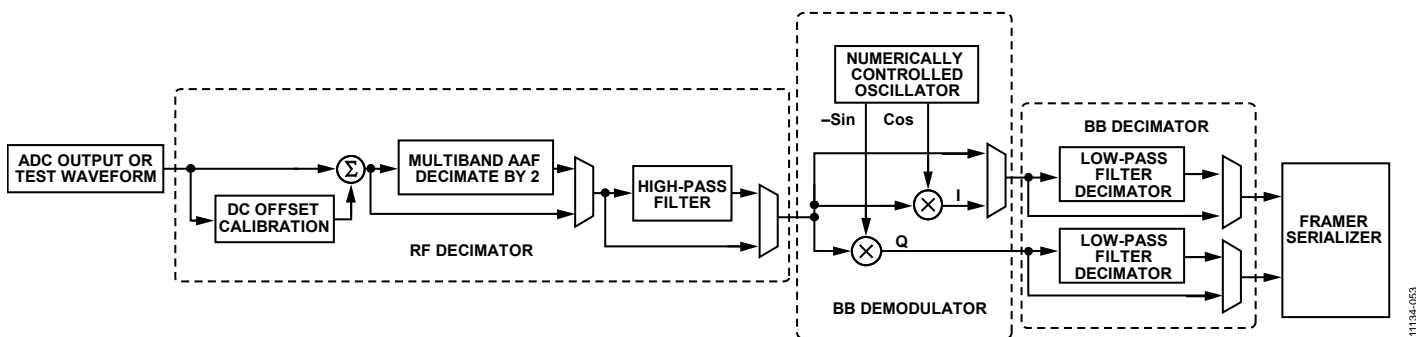

Figure 56. Simplified Block Diagram of a Single Channel of Demodulator/Decimator

Table 27. Profile Definition

Field	No. of Bits	Description
f	16	Demodulation frequency ( $f_D$ ) $f_D = f \times f_{\text{SAMPLE}}/2^{16}$ , where $(f) = [0, (2^{16} - 1)]$ and $f_{\text{SAMPLE}}$ is the effective sample rate 0x0000: $f_D = 0$ (dc, $I = \cos(0) = 1$ , $Q = \sin(0) = 0$ ) 0x0001: $f_D = f_{\text{SAMPLE}}/2^{16}$ ... 0x8000: $f_D = f_{\text{SAMPLE}}/2$ ... 0xFFFF ( $2^{16} - 1$ ): $f_D = f_{\text{SAMPLE}} (2^{16} - 1)/2^{16} = -f_{\text{SAMPLE}}/2^{16}$

## Data Sheet

AD9671

Field	No. of Bits	Description
P	8	Pointer to coefficient block. The coefficients used begin at Coefficient $P \times 8$ and continues for $M \times 8$ coefficients, for example, 0000 0000: points to Coefficient 0 and continues $M \times 8$ coefficients 0000 0001: points to Coefficient 8 and continues $M \times 8$ coefficients
M	5	Decimation factor $M = N - 1$ , where $N$ = decimation factor 0x00: decimate by 1 (no decimation, just filtering) 0x01: decimate by 2 0x02: decimate by 3 ... 0x1F: decimate by 32
g	3	Digital gain compensation Gain = 2 000: gain = 1 (no shift) 001: gain = 2 (shift by 1) 010: gain = 4 (shift by 2) ... 111: gain = 128 (shift by 7)
HPF Bypass	1	Digital high-pass filter bypass 0 = disable (filter enabled) 1 = enable (filter bypassed)
POWER_START	15	ADC clock cycles counted from the TX_TRIG signal assertion when the active channels are powered up 0x0000 = 0 clock cycles 0x0001 = 1 clock cycle ... 0x7FFF = 32,767 clock cycles
Reserved	1	Reserved
POWER_STOP	15	ADC clock cycles counted from the TX_TRIG signal assertion when the active channels are powered down 0x0000 = 0 clock cycles 0x0001 = 1 clock cycle ... 0x7FFF = continuous run mode

## RF DECIMATOR

The input to the RF decimator is either the ADC output data or a test waveform, as described in the Digital Test Waveforms section. The test waveforms are enabled per channel using Address 0x11A (see Table 33).

### DC Offset Calibration

The user can reduce dc offset through a manual system calibration process. Measure the dc offset of every channel in the system and then set a calibration value using Address 0x110 and Address 0x111. Note that these registers are both chip and local addresses, meaning that they are accessed using the chip address and device index. Bypass the dc offset calibration using Address 0x10F, Bits[2:0].

### Multiband AAF and Decimate by 2

The multiband filter is a finite impulse response (FIR) filter. It is programmable with low or high bandwidth filtering. The filter requires 11 input samples to populate the filter. The decimation rate is fixed at  $2\times$ . Therefore, the decimation frequency is  $f_{DEC} =$

$f_{SAMPLE}/2$ . Figure 57 and Figure 58 show the frequency response of the filter, depending on the mode. Figure 57 shows the attenuation amplitude over the Nyquist frequency range. Figure 58 shows the pass band response as nearly flat.

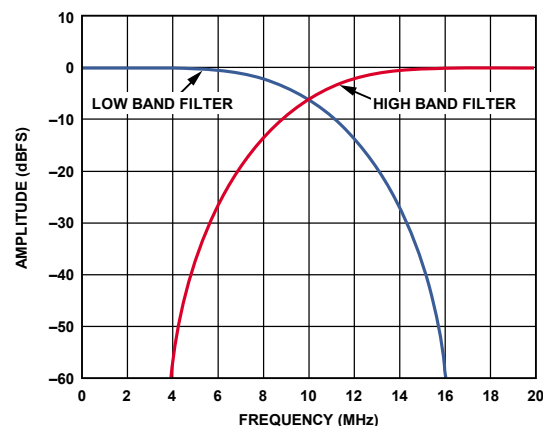

Figure 57. AAF Frequency Response (Frequency Scale Assumes  $f_{ADC} = 2 \times f_{DEC} = 40$  MHz)

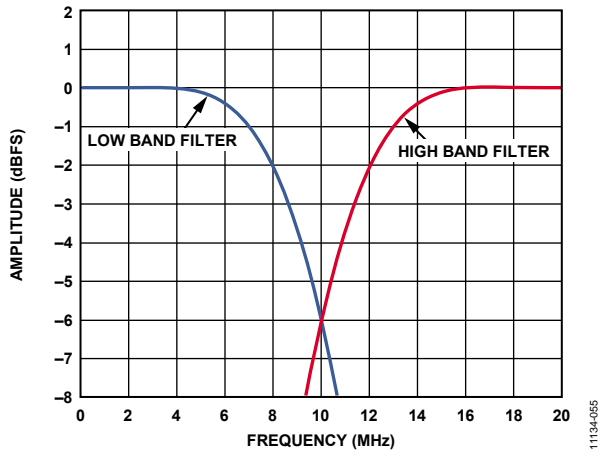

Figure 58. AAF Frequency Response, Zoomed In (Frequency Scale Assumes  $f_{ADC} = 2 \times f_{DEC} = 40$  MHz)

### High-Pass Filter

The user can apply a second-order Butterworth, high-pass infinite impulse response (IIR) filter after the RF decimator. The filter has a cutoff of 700 kHz for an encode clock of 50 MHz. The filter has a settling time of 2.5  $\mu$ s. Therefore, if the ADC clock is 50 MHz, ignore the first 125 samples (2.5  $\mu$ s/0.02  $\mu$ s). Bypass or enable the filter in the vector profile if the filter is enabled in Register 0x113, Bit 5. If the filter is bypassed by setting Register 0x113, Bit 5 = 1, the filter cannot be enabled from the vector profile.

### BASEBAND DEMODULATOR AND DECIMATOR

The demodulator downconverts the RF signal to a baseband quadrature signal. The excess oversampling is reduced by the decimator.

### Numerically Controlled Oscillator

The numerically controlled oscillator (NCO) generates I and Q signals (cos and -sin) for the demodulator. A division of the effective sample clock generates the oscillator frequency. If the RF decimator is bypassed, the effective sample clock is the same as the ADC clock. If the RF decimator is enabled, the effective clock rate is  $\frac{1}{2}$  the ADC sample clock frequency. The divider is set in the vector profile. The oscillator has a frequency resolution of 1 kHz. To synchronize different devices, the NCO is reset upon assertion of TX\_TRIG $\pm$ .

### Decimation Filter

The purpose of the decimation filter is to band limit the demodulated signal prior to decimation. The filter is a polyphase FIR filter and uses 16 taps per decimation with symmetrical coefficients. Therefore, there are eight unique 14-bit coefficients per decimation. The decimation rate and a pointer to the coefficients used by the filter are set in the vector profile. Digital gain from 1 to 128 is applied to the filter response. The digital gain compensation is set in the vector profile.

The filter is reset upon assertion of TX\_TRIG $\pm$ . The decimation filter takes  $32 \times$  the decimation input samples or 32 output samples to populate.

### Coefficient Memory

The coefficient memory stores the eight coefficients per decimation, with a maximum decimation of 32, in a coefficient memory block. At a maximum decimation of 32,  $32 \times 8 = 256$  coefficients is needed. The coefficient memory is available at SPI Address 0x1000 to Address 0x1FFF. This memory is sufficient space to store up to 2048 coefficients. Each vector profile has a pointer, P, to the coefficient block within coefficient memory.

Coefficients are written using the SPI in stream mode during startup. Coefficients are written in  $14\text{-bit} \times 8\text{-word} = 112\text{-bit}$  blocks. There are 256 coefficient blocks. The 14 bits  $\times$  8-word coefficients are packed into 14 bytes  $\times$  8 bits, as shown in Table 29.

Writes and reads from a coefficient block must begin on a coefficient block boundary and an entire coefficient block must be written or read. After a coefficient block is written, the coefficient block address automatically increments/decrements (depending on the LSB/MSB SPI setting in Register 0x000) to the next coefficient block.

Having a direct map between SPI memory address and coefficient block address requires a divide by 7, which is not simple to accomplish in hardware (the address must be mapped within a single cycle). Therefore, each block is padded to a 16-byte boundary, but the SPI does not need to shift in these extra two bytes when loading coefficient memory sequentially. If the SPI is configured LSB first, SPIADDR[3:0] is all 0s. If the SPI is configured MSB first, SPIADDR[3:0] is all 1s. In other words, in LSB mode, the referenced addresses for the coefficient memory blocks are 0x1000, 0x2000, and so on, whereas in MSB SPI mode, the referenced block addresses are 0x100F, 0x200F, and so on.

Coefficient block order and how words/bytes are split across each other are shown in Table 29. When the SPI is configured LSB first, C0[0] = B0[0] is written first, and C7[13] = B13[7] is written last. When the SPI is configured MSB first, C7[13] = B13[7] is written first, and C0[0] = B0[0] is written last.

The position of a coefficient,  $C_n$ , in memory is determined from its index ( $i, j$ ) by

$$n = M(1 + i) - (1 + j), \text{ if } i \text{ is even} \quad (8)$$

$$n = M \times i + j, \text{ if } i \text{ is odd} \quad (9)$$

where

$M$  is the decimation factor.

$j$  is the decimation phase from 0 to  $M - 1$ .

$i$  is the index within the coefficient block, from 0 to 7.

Due to symmetry, Coefficient C0 is multiplied by the newest and oldest samples.

As an example, the coefficient memory for a decimation factor of  $M = 4$  is shown in Table 28.

The upper 16 bits of the filter output are used as the data output of the channel. The filter output may have gain applied according to  $g$ , from the vector profile. Additionally, a gain of 4 can be applied using the filter output gain in Register 0x113, Bit 4.

Table 28. Coefficient Memory for M = 4

Decimation Phase (j)	Index (i)							
	7	6	5	4	3	2	1	0
0	28	27	20	19	12	11	4	3
1	29	26	21	18	13	10	5	2
2	30	25	22	17	14	9	6	1
3	31	24	23	16	15	8	7	0

Table 29. Coefficient Block Mapping into SPI Memory Location

Coefficients (Eight Words × 14 Bits)													
C7[13:0]	C6[13:0]	C5[13:0]	C4[13:0]	C3[13:0]	C2[13:0]	C1[13:0]	C0[13:0]						
111:98	97:84	83:70	69:56	55:42	41:28	27:14	13:0						
SPI Memory (14 Bytes)													
B13[7:0]	B12[7:0]	B11[7:0]	B10[7:0]	B9[7:0]	B8[7:0]	B7[7:0]	B6[7:0]	B5[7:0]	B4[7:0]	B3[7:0]	B2[7:0]	B1[7:0]	B0[7:0]
111:104	103:96	95:88	87:80	79:72	71:64	63:56	55:48	47:40	39:32	31:24	23:16	15:8	7:0

## DIGITAL TEST WAVEFORMS

Digital test waveforms can be used in the digital processing block instead of the ADC output. To enable digital test waveforms, use Address 0x11B. Enable each channel individually in Address 0x11A.

### Waveform Generator

For testing and debugging, use a programmable waveform generator in place of ADC data. The waveform generator can vary offset, amplitude, and frequency. The generator uses the ADC sample frequency,  $f_{SAMPLE}$ , and ADC full-scale amplitude,  $A_{FULL-SCALE}$ , as references. The values are set in Address 0x117, Address 0x118, and Address 0x119 (see Table 33).

$$x = C + A \times \sin(2 \times \pi \times N) \quad (10)$$

$$N = \frac{f_{SAMPLE} \times n}{64}, \text{ see Address 0x117} \quad (11)$$

$$A = \frac{A_{FULL-SCALE}}{2^x}, \text{ see Address 0x118} \quad (12)$$

$$C = A_{FULL-SCALE} \times a \times 2^{-(13-b)}, \text{ see Address 0x119} \quad (13)$$

### Channel ID and Ramp Generator

In Channel ID test mode, the output is a concatenated value. Bits[6:0] are a ramp. Bit 7 is 0 in real data mode or I channel and 1 for Q channel in complex data mode. Bits[10:8] are the channel ID such that Channel A is coded as 000 and Channel B is 001. Bits[15:11] are the chip address.

### Filter Coefficients

To check the filter coefficients, use a sequence of 1 followed by 0s for the input to the decimating FIR filter. The number of 0s is the decimation rate times the number of taps (16). The output shifter outputs the LSBs of the filter.

## DIGITAL BLOCK POWER SAVING SCHEME

To reduce power consumption in the digital block, the demodulator and decimation filter start in an idle state after running the chip (Register 0x008, Bits[2:0] = 000). In the digital idle state, the chip JESD204B block outputs zeroes and there is no unnecessary digital processing of the ADC output data. The digital block only switches to a running state when the negative edge of the TX\_TRIG± pulse is detected, or with a software TX\_TRIG± write (Register 0x10C, Bit 5 = 1).

To put the digital block back into the idle state (while the rest of the chip is still running) and to save power, enact one of the following three events: raise the TX\_TRIG± signal high, write to the profile index (Register 0x10C, Bits[0:4]), or allow the power stop to expire by using the advanced power control feature. Figure 59 illustrates the digital block power saving scheme.

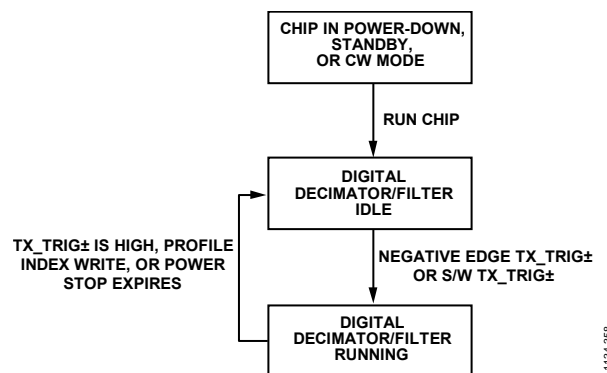

Figure 59. Digital Block Power Saving Scheme

11134-358

## SERIAL PORT INTERFACE (SPI)

The AD9671 SPI allows the user to configure the signal chain for specific functions or operations through the structured register space provided inside the chip. The SPI offers the user added flexibility and customization, depending on the application. Addresses are accessed via the serial port and can be written to or read from via the port. Memory is organized into bytes that can be further divided into fields, as documented in the Memory Map section. For detailed operational information, see the [AN-877 Application Note, Interfacing to High Speed ADCs via SPI](#).

Three pins define the serial port interface: SCLK, SDIO, and CSB (see Table 30). The SCLK (serial clock) pin synchronizes the read and write data presented to the device. The SDIO (serial data input/output) pin is a dual-purpose pin that allows data to be sent to and read from the internal memory map registers of the device. The CSB (chip select bar) pin is an active low control that enables or disables the read and write cycles.

**Table 30. Serial Port Pins**

Pin	Function
SCLK	Serial clock. Serial shift clock input. SCLK synchronizes serial interface reads and writes.
SDIO	Serial data input/output. Dual-purpose pin that typically serves as an input or an output, depending on the instruction sent and the relative position in the timing frame.
CSB	Chip select bar (active low). This control gates the read and write cycles.

The falling edge of CSB, in conjunction with the rising edge of SCLK, determines the start of the framing sequence. During the instruction phase, a 16-bit instruction is transmitted, followed by one or more data bytes, which is determined by Bit Field W0 and Bit Field W1. An example of the serial timing and its definitions are shown in Figure 61 and Table 31.

During normal operation, CSB signals to the device that SPI commands are to be received and processed. When CSB is brought low, the device processes SCLK and SDIO to execute instructions. Normally, CSB remains low until the communication cycle is complete. However, if connected to a slow device, CSB can be brought high between bytes, allowing older microcontrollers enough time to transfer data into shift registers. CSB can be stalled when transferring one, two, or three bytes of data. When W0 and W1 are set to 11, the device enters streaming mode and continues to process data, either reading or writing, until CSB is taken high to end the communication cycle. CSB being high allows complete memory transfers without the need for additional instructions. Regardless of the mode, if CSB is taken high in the middle of a byte transfer, the SPI state machine is reset, and the device waits for a new instruction.

The SPI port can be configured to operate in different manners. CSB can also be tied low to enable 2-wire mode. When CSB is tied low, SCLK and SDIO are the only pins required for

communication. Although the device is synchronized during power-up, exercise caution when using 2-wire mode to ensure that the serial port remains synchronized with the CSB line. When operating in 2-wire mode, use a 1-, 2-, or 3-byte transfer exclusively. Without an active CSB line, streaming mode can be entered but not exited.

In addition to word length, the instruction phase determines whether the serial frame is a read or write operation, allowing the serial port to be used both to program the chip and to read the contents of the on-chip memory. If the instruction is a read-back operation, performing a readback causes the serial data input/output (SDIO) pin to change direction from an input to an output at the appropriate point in the serial frame.

The user can send data in MSB first mode or LSB first mode. MSB first mode is the default at power-up and is changed by adjusting the configuration register (Address 0x000). For more information about this and other features, see the [AN-877 Application Note, Interfacing to High Speed ADCs via SPI](#).

## HARDWARE INTERFACE

The pins described in Table 30 constitute the physical interface between the programming device and the serial port of the AD9671. The SCLK and CSB pins function as inputs when using the SPI. The SDIO pin is bidirectional, functioning as an input during write phases and as an output during readback.

If multiple SDIO pins share a common connection, ensure that proper  $V_{OH}$  levels are met. Figure 60 shows the number of SDIO pins that can be connected together and the resulting  $V_{OH}$  level, assuming the same load for each AD9671.

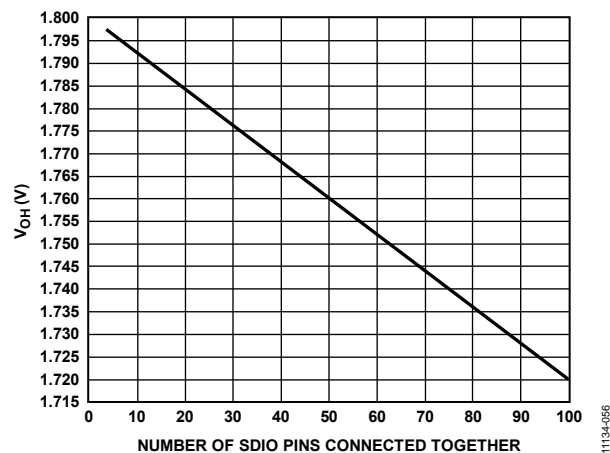

Figure 60. SDIO Pin Loading

This interface is flexible enough to be controlled either by serial programmable read only memories (PROMs) or by PIC microcontrollers, which provide the user with an alternative to a full SPI controller for programming the device (see the [AN-812 Application Note, Microcontroller-Based Serial Port Interface \(SPI®\) Boot Circuit](#)).

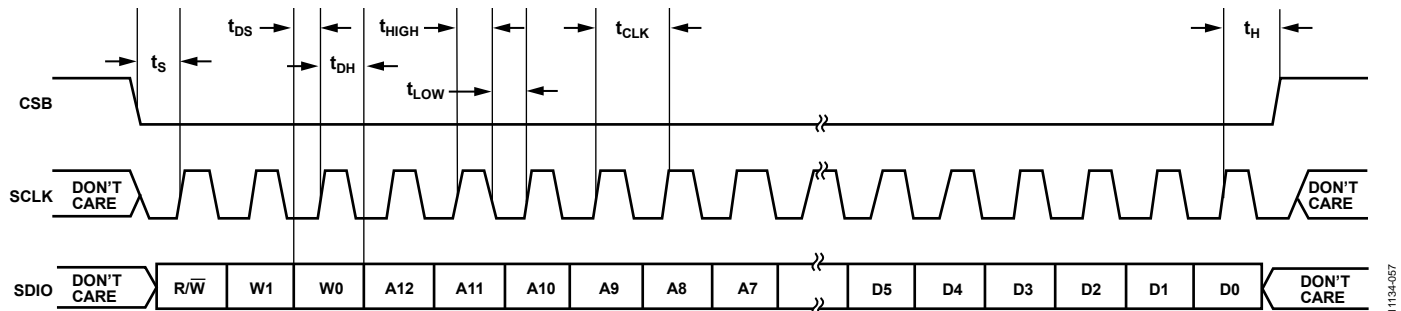

Figure 61. Serial Timing Details

Table 31. Serial Timing Definitions

Parameter	Timing (ns min)	Description
$t_{DS}$	12.5	Setup time between the data and the rising edge of SCLK
$t_{DH}$	5	Hold time between the data and the rising edge of SCLK
$t_{CLK}$	40	Period of the clock
$t_s$	5	Setup time between CSB and SCLK
$t_H$	2	Hold time between CSB and SCLK
$t_{HIGH}$	16	Minimum period that SCLK must be in a logic high state
$t_{LOW}$	16	Minimum period that SCLK must be in a logic low state
$t_{EN\_SDIO}$	15	Minimum time for the SDIO pin to switch from an input to an output relative to the SCLK falling edge (not shown in Figure 61)
$t_{DIS\_SDIO}$	15	Minimum time for the SDIO pin to switch from an output to an input relative to the SCLK rising edge (not shown in Figure 61)

## MEMORY MAP

### READING THE MEMORY MAP TABLE

Each row in the memory map register table has eight bit locations. The memory map is roughly divided into three sections: the chip configuration register map (Address 0x000 to Address 0x19C), the profile register map (Address 0xF00 to Address 0xFFF), and the coefficient register map (Address 0x1000 to Address 0x1FFF). Registers that are designated as local registers use the device index in Address 0x004 and Address 0x005 to determine to which channels of a device the command is applied. Registers that are designated as chip registers use the chip address mode in Address 0x115 to determine whether the device is to be updated by writing to the chip register.

The first column of the memory map indicates the register address, and the default value is shown in the second rightmost column. The Bit 7 (MSB) column is the start of the default hexadecimal value given. For example, Address 0x011, the LNA and VGA gain adjustment register, has a default value of 0x06, meaning that Bit 7 = 0, Bit 6 = 0, Bit 5 = 0, Bit 4 = 0, Bit 3 = 0, Bit 2 = 1, Bit 1 = 1, and Bit 0 = 0, or 0000 0110 in binary. This setting is the default for GAIN± pins enabled, PGA gain = 24 dB and LNA gain = 21.6 dB.

For more information about the SPI memory map and other functions, see the [AN-877 Application Note, Interfacing to High Speed ADCs via SPI](#).

**Table 32. AD9671 SPI Write Start-Up Sequence Example**

Address	Value	Description
0x000	0x3C	Initiate SPI reset
0x002	0x0X (default)	Set speed mode to 40 MSPS
0x0FF	0x01	Enable speed mode change
0x004	0x0F	Set local registers to all channels
0x005	0x3F	Set local registers to all channels
0x113	0x03	Bypass demodulator and decimator, bypass RF decimator, enable high pass filter
0x011	0x06 (default)	Set LNA gain = 21.6 dB, GAIN± pins enabled, and PGA gain = 24 dB
0xF00	0xFF	Continuous run mode enable; do not power down channels (POWER_STOP LSB)
0xF01	0x7F	Continuous run mode enable; do not power down channels (POWER_STOP MSB)
0xF02	0x00	Power up all channels 0 clock cycles after TX_TRIG± signal assertion (POWER_START LSB)
0xF03	0x80	Digital high-pass bypassed (POWER_START MSB)
0xF04	0x0C	Decimate by 2 (M = 00001); digital gain = 16 (g = 100)
0xF05	0x00	Point to Coefficient Block 00
0xF06	0x00	demodulation frequency = $f_{\text{SAMPLE}}/8$
0xF07	0x20	demodulation frequency = $f_{\text{SAMPLE}}/8$
0x10C <sup>1</sup>	0x00 (default)	Set index profile (required after profile memory writes)
0x014	0x00	Set output data format
0x008	0x00	Chip run (TGC mode) <sup>2</sup>
0x021	0x12	16-bit, four-lane mode
0x199	0x80	Enables automatic serializer/deserializer (SERDES) sample clock counter
0x142	0x04	ILAS enabled
0x188	0x01	Enable start code identifier
0x18B	0x27	Set START_CODE MSB
0x18C	0x72	Set START_CODE LSB

### RESERVED LOCATIONS

Do not write to undefined memory locations except when writing the default values suggested in this data sheet. Addresses that have values marked as 0 must be considered reserved and have a 0 written into their registers during power-up.

### DEFAULT VALUES

After a reset, critical registers are automatically loaded with default values. These values are indicated in Table 33, where an X refers to an undefined feature (don't care).

### LOGIC LEVELS

An explanation of various registers follows: “bit is set” is synonymous with “bit is set to Logic 1” or “writing Logic 1 for the bit.” Similarly, “bit is cleared” is synonymous with “bit is set to Logic 0” or “writing Logic 0 for the bit.”

### RECOMMENDED START-UP SEQUENCE

To save system power during programming, the AD9671 powers up in power-down mode. To start the device up and initialize the data interface, the SPI commands listed in Table 32 are recommended. At a minimum, write the profile memory for an index of 0 (Address 0xF00 to Address 0xF07; see Table 27). If additional profiles and coefficient memory are required, write these after Profile File Memory 0.

## Data Sheet

AD9671

Address	Value	Description
0x150	0x03	JESD204B scrambler disabled and four-lane configuration (L = 4)
0x182	0x82	Autoconfigures PLL
0x181	0x02	PLL N divider = $\div 20$
0x186	0xAA	Disable continuous data resync (continuous data resync is not recommended during real-time scanning; one-time data resync is sufficient)
0x10C <sup>3</sup>	0x20	Set SPI TX_TRIG $\pm$ and index profile
0x00F	0x18	Set low-pass filter cutoff frequency, bandwidth mode
0x02B	0x40	Set analog LPF and HPF to defaults, tune filters <sup>4</sup>

<sup>1</sup> Setting the profile index requires an additional SPI write in SPI MSB mode before the chip is run to complete the current profile buffer update.

<sup>2</sup> Running the chip from full power-down mode requires 375  $\mu$ s wake-up time as listed in Table 3.

<sup>3</sup> The software TX\_TRIG trigger switches the demodulator/decimator digital block to a running state. It may not be needed if hardware the TX\_TRIG signal is used to run the digital block.

<sup>4</sup> Tuning the filters requires 512 ADC clock cycles.

**AD9671****Data Sheet****Table 33. AD9671 Memory Map Registers**

Addr. (Hex)	Register Name	Bit 7 (MSB)	Bit 6	Bit 5	Bit 4	Bit 3	Bit 2	Bit 1	Bit 0 (LSB)	Default Value	Comments
<b>Chip Configuration Registers</b>											
0x000	CHIP_PORT_CONFIG	0	LSB first 0 = off (default) 1 = on	SPI reset 0 = off (default) 1 = on	1	1	SPI reset 0 = off (default) 1 = on	LSB first 0 = off (default) 1 = on	0	0x18	Nibbles mirrored so that LSB or MSB first mode is set correctly, regardless of shift mode. SPI reset reverts all registers (including the JESD ones), except Reg. 0x000 to their default values and Reg. 0x000, Bit 2 and Bit 5 are automatically cleared.
0x001	CHIP_ID	Chip ID Bits[7:0] AD9671 = 0xA7 (default)								0xA7	Default is unique chip ID, different for each device; read only register.
0x002	CHIP_GRADE	X	X	Speed mode (identify device variants of chip ID) 00: Mode I (40 MSPS) (default) 01: Mode II (65 MSPS) 10: Mode III (80 MSPS) 11: Mode III (125 MSPS)	X	X	X	X	X	0x0X	Speed mode used to differentiate ADC speed power modes (must update Reg. 0x0FF to initiate mode setting).
<b>Device Index and Update Registers</b>											
0x004	DEVICE_INDEX_2	X	X	X	X	Data Channel H 0 = off 1 = on (default)	Data Channel G 0 = off 1 = on (default)	Data Channel F 0 = off 1 = on (default)	Data Channel E 0 = off 1 = on (default)	0x0F	Bits are set to determine which on-chip device receives the next write command.
0x005	DEVICE_INDEX_1	X	X	1	1	Data Channel D 0 = off 1 = on (default)	Data Channel C 0 = off 1 = on (default)	Data Channel B 0 = off 1 = on (default)	Data Channel A 0 = off 1 = on (default)	0x3F	Bits are set to determine which on-chip device receives the next write command.

## Data Sheet

AD9671

Addr. (Hex)	Register Name	Bit 7 (MSB)	Bit 6	Bit 5	Bit 4	Bit 3	Bit 2	Bit 1	Bit 0 (LSB)	Default Value	Comments
0x0FF	DEVICE_UPDATE	X	X	X	X	X	X	X	X	0x00	A write to Reg. 0x0FF (the value does not matter) resets all default register values (analog and ADC registers only not, JESD204B registers and not Reg. 0x000 or Reg. 0x002, Bits[5:4]) if Reg 0x02 has been previously written since the last reset/load of defaults.
Program Function Registers											
0x008	GLOBAL_MODES	X	LNA input impedance 0 = 6 kΩ (default) 1 = 3 kΩ	X	0	0	Internal power-down mode 000 = chip run (TGC mode) 001 = full power-down (default) 010 = standby 011 = reset all JESD registers 100 = CW mode (TGC power-down)		0x01	Determines generic modes of chip operation (global).	
0x009	GLOBAL_CLOCK	X	X	X	X	X	X	X	DCS 0 = off 1 = on (default)	0x01	Turns the internal duty cycle stabilizer (DCS) on and off (global).
0x00A	PLL_STATUS	PLL lock status 0 = not locked 1 = locked	X	X	X	X	X	X	JESD204B link ready status 0 = link not ready (default) 1 = link ready, PLL locked	0x00	Monitor PLL lock and link ready status (read only, global).
0x00D	TEST_IO	User test mode 0 = continuous, repeat user patterns (1, 2, 3, 4, 1, 2, 3, 4, ...) (default) 1 = single clock cycle user patterns, then zeros (1, 2, 3, 4, 0, 0, ...)	X	Reset PN long gen 0 = on, PN long running (default) 1 = off, PN long held in reset	Reset PN short gen 0 = on, PN short running (default) 1 = off, PN short held in reset	Output test mode 0000 = off (default) 0001 = midscale short 0010 = +FS short 0011 = -FS short 0100 = checkerboard output 0101 = PN sequence long 0110 = PN sequence short 0111 = one-/zero-word toggle 1000 = user input 1001 to 1110 = reserved 1111 = ramp output			0x00	When this register is set, the test data is placed on the output pins in place of normal data (local).	
0x00E	GPO	X	X	X	X	General-purpose digital outputs			0x00	Values placed on GPO0 to GPO3 pins (global).	

## AD9671

## Data Sheet

Addr. (Hex)	Register Name	Bit 7 (MSB)	Bit 6	Bit 5	Bit 4	Bit 3	Bit 2	Bit 1	Bit 0 (LSB)	Default Value	Comments
0x00F	FLEX_CHANNEL_INPUT						BW mode 0 = low (default, 8 MHz to 18 MHz) 1 = high (13.5 MHz to 30 MHz)	X	X	0x18	Antialiasing filter cutoff (global).
											Filter cutoff frequency control 0 0000 = $1.45 \times (1/3) \times f_{\text{SAMPLE}}$ 0 0001 = $1.25 \times (1/3) \times f_{\text{SAMPLE}}$ 0 0010 = $1.13 \times (1/3) \times f_{\text{SAMPLE}}$ 0 0011 = $1.0 \times (1/3) \times f_{\text{SAMPLE}}$ (default) 0 0100 = $0.9 \times (1/3) \times f_{\text{SAMPLE}}$ 0 0101 = $0.8 \times (1/3) \times f_{\text{SAMPLE}}$ 0 0110 = $0.75 \times (1/3) \times f_{\text{SAMPLE}}$ 0 0111 = not applicable 0 1000 = $1.45 \times (1/4.5) \times f_{\text{SAMPLE}}$ 0 1001 = $1.25 \times (1/4.5) \times f_{\text{SAMPLE}}$ 0 1010 = $1.13 \times (1/4.5) \times f_{\text{SAMPLE}}$ 0 1011 = $1.0 \times (1/4.5) \times f_{\text{SAMPLE}}$ 0 1100 = $0.9 \times (1/4.5) \times f_{\text{SAMPLE}}$ 0 1101 = $0.8 \times (1/4.5) \times f_{\text{SAMPLE}}$ 0 1110 = $0.75 \times (1/4.5) \times f_{\text{SAMPLE}}$ 0 1111 = not applicable 1 0000 = $1.45 \times (1/6) \times f_{\text{SAMPLE}}$ 1 0001 = $1.25 \times (1/6) \times f_{\text{SAMPLE}}$ 1 0010 = $1.13 \times (1/6) \times f_{\text{SAMPLE}}$ 1 0011 = $1.0 \times (1/6) \times f_{\text{SAMPLE}}$ 1 0100 = $0.9 \times (1/6) \times f_{\text{SAMPLE}}$ 1 0101 = $0.8 \times (1/6) \times f_{\text{SAMPLE}}$ 1 0110 = $0.75 \times (1/6) \times f_{\text{SAMPLE}}$ 1 0111 = not applicable
0x010	FLEX_OFFSET	X	X	1	0	0	0	0	0	0x20	Reserved.
0x011	FLEX_GAIN						PGA gain 00 = 21 dB 01 = 24 dB (default) 10 = 27 dB 11 = 30 dB		LNA gain 00 = 15.6 dB 01 = 17.9 dB 10 = 21.6 dB (default) 11 = reserved	0x06	LNA and PGA gain adjustment (global).
											Digital VGA gain control 0000 = GAIN± pins enabled (default) 0001 = 0.0 dB (maximum gain, GAIN± pins disabled) 0010 = -3.5 dB 0011 = -7.0 dB ... 1110 = -45 dB 1111 = reserved (do not use)
0x012	BIAS_CURRENT	X	X	X	X	1	PGA bias 0 = 100% (default) 1 = 60%		LNA bias 00 = high 01 = midhigh (default) 10 = midlow 11 = low	0x09	LNA bias current adjustment (global).
0x013	RESERVED_13	0	0	0	0	0	0	0	0	0x00	Reserved.
0x014	OUTPUT_MODE	X	X	X		X	Output data invert 0 = disable (default) 1 = enable		Output data format 00 = offset binary 01 = twos complement (default) 10 = gray code 11 = reserved	0x01	Data output modes (local).
											Output data enable 0 = enable (default) 1 = disable
0x015	OUTPUT_ADJUST	X				X	X		Output pre-emphasis 0 = off (default) 1 = on	0x61	Data output levels (global).
											CML output drive level adjustment 000 = reserved 001 = reserved 010 = 368 mV 011 = reserved 100 = 293 mV 101 = 286 mV 110 = 262 mV (default) 111 = 238 mV
0x016	RESERVED_16	X	X	X	X	X	X	X	X	0x00	Reserved (global).
0x017	RESERVED_17	X	X	X	X	X	X	X	X	0x00	Reserved (global).
0x018	FLEX_VREF	X	X	X	X	X	1	0	0	0x04	Reserved (global).
0x019	USER_PATT1_LSB	B7	B6	B5	B4	B3	B2	B1	B0	0x00	User-Defined Pattern 1, LSB (global).

## Data Sheet

## AD9671

Addr. (Hex)	Register Name	Bit 7 (MSB)	Bit 6	Bit 5	Bit 4	Bit 3	Bit 2	Bit 1	Bit 0 (LSB)	Default Value	Comments
0x01A	USER_PATT1_MSB	B15	B14	B13	B12	B11	B10	B9	B8	0x00	User-Defined Pattern 1, MSB (global).
0x01B	USER_PATT2_LSB	B7	B6	B5	B4	B3	B2	B1	B0	0x00	User-Defined Pattern 2, LSB (global).
0x01C	USER_PATT2_MSB	B15	B14	B13	B12	B11	B10	B9	B8	0x00	User-Defined Pattern 2, MSB (global).
0x01D	USER_PATT3_LSB	B7	B6	B5	B4	B3	B2	B1	B0	0x00	User-Defined Pattern 3, LSB (global).
0x01E	USER_PATT3_MSB	B15	B14	B13	B12	B11	B10	B9	B8	0x00	User-Defined Pattern 3, MSB (global).
0x01F	USER_PATT4_LSB	B7	B6	B5	B4	B3	B2	B1	B0	0x00	User-Defined Pattern 4, LSB (global).
0x020	USER_PATT4_MSB	B15	B14	B13	B12	B11	B10	B9	B8	0x00	User-Defined Pattern 4, MSB (global).
0x021	FLEX_SERIAL_CTRL	0	X	Lane mode 00 = reserved (default) 01 = 2 channels/lane (4 lanes) 10 = 4 channels/lane (2 lanes) 11 = 8 channels/lane (1 lane)		Lane low rate: 0 = normal (default) 1 = low output rate (<1 Gbps)	X	Output word length 00 = 12 bits (default) 01 = 14 bits 10 = 16 bits 11 = reserved		0x00	Lane setting control (global).
0x022	SERIAL_CH_STAT	X	X	X	X	X	X	X	Channel power-down 1 = on 0 = off (default)	0x00	Used to power down individual channels (local).
0x02B	FLEX_FILTER	X	Enable automatic low-pass tuning 1 = on (self clearing)	X	X	Bypass analog HPF 0 = off (default) 1 = on	X	Analog high-pass filter cutoff 00 = $f_{LP}/12.00$ (default) 01 = $f_{LP}/9.00$ 10 = $f_{LP}/6.00$ 11 = $f_{LP}/3.00$		0x00	Filter cutoff (global) ( $f_{LP}$ = low-pass filter cutoff frequency).
0x02C	LNA_TERM	X	X	X	X	X	X	LO-x, LOSW-x connection 00 = $R_{FB1} + 50 \Omega$ (default) 01 = $(R_{FB1}    R_{FB2}) + 50 \Omega$ 10 = $R_{FB2} + 50 \Omega$ 11 = $\infty$		0x00	LNA active termination/ input impedance (global).
0x02D	CW_ENABLE_PHASE	X	X	X	CW Doppler channel enable 1 = on 0 = off	I/Q demodulator phase 0000 = $0^\circ$ (default) 0001 = $22.5^\circ$ (not valid for 4LO mode) 0010 = $45^\circ$ 0011 = $67.5^\circ$ (not valid for 4LO mode) 0100 = $90^\circ$ 0101 = $112.5^\circ$ (not valid for 4LO mode) 0110 = $135^\circ$ 0111 = $157.5^\circ$ (not valid for 4LO mode) 1000 = $180^\circ$ 1001 = $202.5^\circ$ (not valid for 4LO mode) 1010 = $225^\circ$ 1011 = $247.5^\circ$ (not valid for 4LO mode) 1100 = $270^\circ$ 1101 = $292.5^\circ$ (not valid for 4LO mode) 1110 = $315^\circ$ 1111 = $337.5^\circ$ (not valid for 4LO mode)			0x00	Phase of demodulators (local, chip).	

## AD9671

## Data Sheet

Addr. (Hex)	Register Name	Bit 7 (MSB)	Bit 6	Bit 5	Bit 4	Bit 3	Bit 2	Bit 1	Bit 0 (LSB)	Default Value	Comments
0x02E	CW_LO_MODE	Enable JESD during CW link disabled during CW (default) 1: JESD link enabled during CW (switching activity can degrade CW performance)	RESET± with MLO± clock edge 0 = synchronous (default) 1 = asynchronous	Synchronous RESET± sampling MLO± clock edge 0 = falling (default) 1 = rising	RESET± polarity 0 = active high (default) 1 = active low	MLO± and RESET± buffer enable (in all modes except CW mode) 0 = power-down (default) 1 = enable	LO mode 00X = 4LO, 3 <sup>rd</sup> to 5 <sup>th</sup> odd harmonic rejection (default) 010 = 8LO, 3 <sup>rd</sup> to 5 <sup>th</sup> odd harmonic rejection 011 = 8LO, 3 <sup>rd</sup> to 13 <sup>th</sup> odd harmonic rejection 100 = 16LO, 3 <sup>rd</sup> to 5 <sup>th</sup> odd harmonic rejection 101 = 16LO, 3 <sup>rd</sup> to 13 <sup>th</sup> odd harmonic rejection 11X = reserved			0x00	CW mode functions (global).
0x02F	CW_OUTPUT	CW output dc bias voltage 0 = bypass 1 = enable (default)	0	0	0	0	0	0	0	0x80	Global.
0x102	RESERVED_102	0	0	0	0	0	0	0	0	0x00	Reserved.
0x103	RESERVED_103	0	0	0	0	0	0	0	0	0x00	Reserved.
0x104	RESERVED_104	0	0	1	1	1	1	1	1	0x3F	Reserved.
0x105	RESERVED_105	0	0	0	0	0	0	0	0	0x00	Reserved.
0x106	RESERVED_106	0	0	0	0	0	0	0	0	0x00	Reserved.
0x107	RESERVED_107	0	0	0	0	0	0	X	X	Read only	Reserved.
0x108	RESERVED_108	0	0	0	0	0	0	0	0	0x00	Reserved.
0x109	VGA_TEST	X	X	X	VGA/AAF test enable 0 = off (default) 1 = on	X	VGA/AAF output test mode 000 = Channel A (default) 001 = Channel B 010 = Channel C 011 = Channel D 100 = Channel E 101 = Channel F 110 = Channel G 111 = Channel H			0x00	VGA/AAF test mode enables AAF output to the GPO2/GPO3 pins (global).
0x10C	PROFILE_INDEX	X	X	Manual TX_TRIG signal 0 = off, use pin (default) 1 = on, auto-generate TX_TRIG (self clears)	Profile index[4:0]					0x00	Index for profile memory selects active profile (global).
0x10D	RESERVED_10D	1	1	1	1	1	1	1	1	0xFF	Reserved.
0x10E	RESERVED_10E	1	1	1	1	1	1	1	1	0xFF	Reserved.

## Data Sheet

AD9671

Addr. (Hex)	Register Name	Bit 7 (MSB)	Bit 6	Bit 5	Bit 4	Bit 3	Bit 2	Bit 1	Bit 0 (LSB)	Default Value	Comments
0x10F	DIG_OFFSET_CAL	0	0	0	0	Digital offset calibration status 0 = not complete (default) 1 = complete	Digital offset calibration 000 = disable correction, reset correction value (default) 001 = average $2^{10}$ samples 010 = average $2^{11}$ samples ... 111 = average $2^{16}$ samples			0x00	Control digital offset calibration enable and number of samples used (global).
0x110	DIG_OFFSET_CORR1	D7	D6	D5	D4	D3	D2	D1	D0	0x00	Offset correction LSB (local, chip).
0x111	DIG_OFFSET_CORR2	D15	D14	D13	D12	D11	D10	D9	D8	0x00	Offset correction MSB (local, chip).
Digital offset calibration (read back if autocalibration enabled with Register 0x10F; otherwise, force correction value) Offset correction = $[D15:D0] \times \text{full scale} / 2^{16}$ 0111 1111 1111 1111 ( $2^{15} - 1$ ) = $+1/2$ full scale – $1/2^{16}$ full scale 0111 1111 1111 1110 ( $2^{15} - 2$ ) = $+1/2$ full scale – $2/2^{16}$ full scale ... 0000 0000 0000 0001 (+1) = $+1/2^{16}$ full scale 0000 0000 0000 0000 = no correction (default) 1111 1111 1111 1111 (–1) = $-1/2^{16}$ full scale ... 1000 0000 0000 0000 ( $-2^{15}$ ) = $-1/2$ full scale											
0x112	POWER_MASK_CONFIG	X	X	X	Power-up setup time (POWER_SETUP) 0 0000 = 0 0 0001 = $1 \times 40/f_{\text{SAMPLE}}$ 0 0010 = $2 \times 40/f_{\text{SAMPLE}}$ (default) 0 0011 = $3 \times 40/f_{\text{SAMPLE}}$ ... 1 1111 = $31 \times 40/f_{\text{SAMPLE}}$			0x02	POWER_SETUP time is used to set the power-up time (global).		
0x113	DIG_DEMOD_CONFIG	X	X	Digital high-pass filter 0 = enable (default) 1 = bypass	Decimator gain scale 0 = no gain (default) 1 = 4x gain (shift decimator output by 2)	Decimator and filter enable 00 = RF 2x decimator bypassed (default) 01 = RF 2x decimator enabled and low bandwidth filter 1X = RF 2x decimator enabled and high bandwidth filter		Baseband decimator 0 = enable (default) 1 = bypass	Demodulator 0 = enable (default) 1 = bypass	0x00	Enable stages of the digital processing (global).
0x115	CHIP_ADDR_EN	X	X	Chip address mode 0 = disable (default) 1 = enable	Chip address qualifier 0 0000 (default) (If read, returns the state of ADDR0 to ADDR4 pins)					0x00	Chip address mode enables the addressing of devices if the value of chip address qualifier equals the state on the address pins, ADDR <sub>x</sub> (global).
0x116	ANALOG_TEST_TONE	X	X	X	X	Analog test tone amplitude (see Table 23 to Table 25)		Analog test tone frequency 00 = $f_{\text{SAMPLE}}/4$ (default) 01 = $f_{\text{SAMPLE}}/8$ 10 = $f_{\text{SAMPLE}}/16$ 11 = $f_{\text{SAMPLE}}/32$		0x00	Analog test tone amplitude and frequency (global).
0x117	DIG_SINE_TEST_FREQ	X	X	X	Digital test tone frequency 0 0000 = $1 \times f_{\text{SAMPLE}}/64$ 0 0001 = $2 \times f_{\text{SAMPLE}}/64$ ... 1 1111 = $32 \times f_{\text{SAMPLE}}/64$					0x00	Digital sine test tone frequency (global).

## AD9671

## Data Sheet

Addr. (Hex)	Register Name	Bit 7 (MSB)	Bit 6	Bit 5	Bit 4	Bit 3	Bit 2	Bit 1	Bit 0 (LSB)	Default Value	Comments
0x118	DIG_SINE_TEST_AMP	X	X	X	X		Digital test tone amplitude 0000 = $A_{FULL-SCALE}$ (default) 0001 = $A_{FULL-SCALE}/2$ 0010 = $A_{FULL-SCALE}/2^2$ ... 1111 = $A_{FULL-SCALE}/2^{15}$			0x00	Digital sine test tone amplitude (global).
0x119	DIG_SINE_TEST_OFFSET	Offset multiplier (a) 0 1111 = 15 0 1110 = 14 ... 0 0000 = 0 (default) 1 1111 = -1 ... 1 0000 = -16					Offset exponent (b) 000 = 0 (default) 001 = 1 ... 111 = 7			0x00	Digital sine test tone offset (global).
		$Offset = A_{FULL-SCALE} \times a \times 2^{-(13-b)}$ Offset range is $\sim 0.5$ dB Maximum positive offset = $15 \times 2^{-(13-7)} = 0.25 \times A_{FULL-SCALE}$ Maximum negative offset = $-16 \times 2^{-(13-7)} \approx -0.25 \times A_{FULL-SCALE}$									
0x11A	TEST_MODE_CH_ENABLE	Ch. H enable 0 = off (default) 1 = on	Ch. G enable 0 = off (default) 1 = on	Ch. F enable 0 = off (default) 1 = on	Ch. E enable 0 = off (default) 1 = on	Ch. D enable 0 = off (default) 1 = on	Ch. C enable 0 = off (default) 1 = on	Ch. B enable 0 = off (default) 1 = on	Ch. A enable 0 = off (default) 1 = on	0x00	Enable channels for test mode (global).
0x11B	TEST_MODE_CONFIG	X	X	X	X	X	Datapath test mode selection 000 = disable test modes (default) 001 = enable digital sine test mode 010 = enable decimator filter test (output of decimator is the sequence of filter coefficients) 011 = enable channel ID test mode (16-bit data = digital ramp (7 bits) + I/Q bit + Channel ID (3 bits) + Chip Address (5 bits)) 100 = enable analog test tone 101 = reserved ... 111 = reserved			0x00	Enable digital test modes (local).
0x11C	RESERVED_11C	0	0	0	0	0	0	0	0	0x00	Reserved.
0x11D	RESERVED_11D	0	0	0	0	0	0	0	0	0x00	Reserved.
0x11E	RESERVED_11E	0	0	0	0	0	0	0	0	0x00	Reserved.
0x11F	RESERVED_11F	0	0	0	0	0	0	0	0	0x00	Reserved.
0x120	CW_TEST_TONE	0	CW I/Q output swap 0 = disable (default) 1 = enable	LNA offset cancellation 0 = enable (default) 1 = disable	LNA offset cancellation transconductance 00 = 0.5 mS (default) 01 = 1.0 mS 10 = 1.5 mS 11 = 2.0 mS	CW analog test tone override for Reg. 0x116, Bits[1:0] 00 = disable override (default) 01 = set analog test tone frequency to $f_{LO}$ 1X = set analog test tone frequency to dc			0	0x00	Sets the frequency of the analog test tone to $f_{LO}$ in CW Doppler mode; enables I/Q output swap; LNA offset cancellation control (global).
0x142	JTX_LINK_CTRL1	JESD204B power during standby 0 = remain powered up (default) 1 = power-down	JESD204B tail bit value 0 = zeros (default) 1: PN sequence	JESD204B test mode enable 0 = disable (default) 1 = enable	JESD204B lane sync enable 0 = disable (default) 1 = enable	JESD204B ILAS enable 00 = disable (default) 01 = enable 10 = always on, test mode 11 = reserved	JESD204B serial frame alignment character insertion (FACI) disable 0: FACI enabled 1: FACI disabled	Power down JESD204B link 0 = link enabled (default) 1 = link powered down	0x00	JESD204B configuration (global).	

## Data Sheet

AD9671

Addr. (Hex)	Register Name	Bit 7 (MSB)	Bit 6	Bit 5	Bit 4	Bit 3	Bit 2	Bit 1	Bit 0 (LSB)	Default Value	Comments
0x143	JTX_LINK_CTRL2			SYNCINB signal polarity 0 = not inverted (default) 1 = inverted	0	0	8B/10B encoder 0 = enable (default) 1 = bypass (test mode only)	10B transmit bit invert 0 = not inverted (default) 1 = inverted SERD-OUTx±	10B transmit bit mirror 0 = not mirrored (default) 1 = mirrored	0x00	JESD204B configuration (global).
0x144	JTX_LINK_CTRL3	Checksum enable 0 = enable (default) 1 = disable	Checksum algorithm 0 = add parameter (default) 1 = add packed octets	JESD204B test pattern input selection 00 = reserved (default) 01 = 10-bit test data injected at output of 8B/10B encoder 10 = 8-bit test data injected at input of scrambler 11 = reserved	JESD204B test mode selection 0000 = off (default) 0001 = alternating checkerboard 0010 = 1-/0-word toggle 0011 = PN sequence long 0100 = PN sequence short 0101 = continuous/repeat user test pattern 0110 = single user test pattern 0111 = ramp output 1000 = modified RPAT sequence 1001 = reserved ... 1111 = reserved					0x00	JESD204B test mode and checksum controls (global).
0x145	JTX_LINK_CTRL4	Initial lane alignment sequence repeat count 0000 0000 = $4 \times K + 1$ (default) 0000 0001 = $4 \times K + 2$ ... 1111 1111 = $4 \times K + 128$								0x00	JESD204B ILAS repeat count (global).
0x146	JTX_DID_CFG	JESD204B serial device identification (DID) number								0x00	Global.
0x147	JTX_BID_CFG	X	X	X	X	JESD204B serial bank identification (BID) number (extension to DID)			0x00	Global.	
0x148	JTX_LID0_CFG	X	X	X	Serial lane identification (LID) number for Lane 1					0x00	Global.
0x149	JTX_LID1_CFG	X	X	X	Serial lane identification (LID) number for Lane 2					0x01	Global.
0x14A	JTX_LID2_CFG	X	X	X	Serial lane identification (LID) number for Lane 3					0x02	Global.
0x14B	JTX_LID3_CFG	X	X	X	Serial lane identification (LID) number for Lane 4					0x03	Global.
0x14C	RESERVED_14C	0	0	0	0	0	0	0	0	0x00	Reserved.
0x14D	RESERVED_14D	0	0	0	0	0	0	0	0	0x00	Reserved.
0x14E	RESERVED_14E	0	0	0	0	0	0	0	0	0x00	Reserved.
0x14F	RESERVED_14F	0	0	0	0	0	0	0	0	0x00	Reserved.
0x150	JTX_SCR_L_CFG	JESD204B serial scrambler mode 0 = disabled 1 = enabled (default)	X	X	X	X	X	Lanes per link 00 = one lane (L = 1) 01 = two lanes (L = 2) 10 = reserved 11 = four lanes (L = 4) (default)		0x83	JESD204B scrambler and lane configuration (global).

## AD9671

## Data Sheet

Addr. (Hex)	Register Name	Bit 7 (MSB)	Bit 6	Bit 5	Bit 4	Bit 3	Bit 2	Bit 1	Bit 0 (LSB)	Default Value	Comments
0x151	JTX_F_CFG	X	X	X	Number of octets per frame (F) $F = (M \times 2) / (L)$ 0 0000 = reserved ... 0 0011 = 4 octets (M = 8, L = 4, default) 0 0100 = reserved ... 0 0111 = 8 octets (M = 8, L = 2) or (M = 16, L = 4) 0 1000 = reserved ... 0 1111 = 16 octets (M = 8, L = 1) or (M = 16, L = 2) 1 0000 = reserved ... 1 1111 = 32 octets (M = 16, L = 1)					0x03	JESD204B number of octets per frame (read only, global).
0x152	JTX_K_CFG	X	X	X	Number of frames per multiframe (K) 0 0000 = 1 0 0001 = 2 ... 1 1111 = 32 (default)					0x0F	JESD204B frames per multiframe (global).
0x153	JTX_M_CFG	X	X	X	X	Number of converters per link 0000 = reserved ... 0111 = 8 channels, real data (M = 8) 1000 = reserved ... 1111 = 8 channels, quadrature data (M = 16)				0x07	JESD204B number of converter per link (read only, global).
0x154	JTX_CS_N_CFG	X	Control bits per sample 0 = none (CS = 0, default, read only)	X	0	Output resolution (N) 0000 = reserved ... 1011 = 12 bits 1100 = reserved 1101 = 14 bits 1110 = reserved 1111 = 16 bits (default)				0x0F	JESD204B serializer number of bits per channel (global).
0x155	JTX_SCV_NP_CFG	0	0	0	0	Bits per output sample (N') 0000 = reserved ... 1110 = reserved 1111 = 16 (default)				0x0F	JESD204B number of bits per samples (global, read only).
0x156	JTX_JV_S_CFG	X	X	Number of clocks SYNCINB signal must be low for synchronization to begin 0 = 2 frame clock cycles 1 = 4 frame clock cycles (default)	0	0	0	0	Samples per channel per frame (S) 0 = 1 sample (default, read only) 1 = 2 samples	0x20	Number of clocks SYNCINB signal must be low for synchronization to begin (global).
0x157	JTX_HD_CF_CFG	0	0	0	Control words per frame clock per link 0 0000 = 0 (default) 0 0001 = reserved ... 1 1111 = reserved					0x00	JESD204B control words per frame (global, read only).
0x158	JTX_RES1_CFG	0	0	0	0	0	0	0	0	0x00	Reserved.
0x159	JTX_RES2_CFG	0	0	0	0	0	0	0	0	0x00	Reserved.

## Data Sheet

AD9671

Addr. (Hex)	Register Name	Bit 7 (MSB)	Bit 6	Bit 5	Bit 4	Bit 3	Bit 2	Bit 1	Bit 0 (LSB)	Default Value	Comments
0x15A	JTX_CHKSUM0_CFG	Checksum value for Lane 1 (FCHK)								0x3C	JESD204B checksum value Lane 1 (global, read only).
0x15B	JTX_CHKSUM1_CFG	Checksum value for Lane 2 (FCHK)								0x3D	JESD204B checksum value Lane 2 (global, read only).
0x15C	JTX_CHKSUM2_CFG	Checksum value for Lane 3 (FCHK)								0x3E	JESD204B checksum value Lane 3 (global, read only).
0x15D	JTX_CHKSUM3_CFG	Checksum value for Lane 4 (FCHK)								0x3F	JESD204B checksum value Lane 4 (global, read only).
0x15E	RESERVED_15E	0	1	1	0	1	1	0	0	0x3C	Reserved.
0x15F	RESERVED_15F	0	1	1	0	1	1	0	0	0x3C	Reserved.
0x160	RESERVED_160	0	1	1	0	1	1	0	0	0x3C	Reserved.
0x161	RESERVED_161	0	1	1	0	1	1	0	0	0x3C	Reserved.
0x170	RESERVED_170	0	0	0	0	0	0	0	0	0x00	Reserved.
0x171	RESERVED_171	1	1	1	1	1	1	1	1	0xFF	Reserved.
0x172	RESERVED_172	1	1	1	1	1	1	1	1	0xFF	Reserved.
0x173	RESERVED_173	0	0	0	0	0	0	0	0	0x00	Reserved.
0x174	RESERVED_174	0	0	0	0	1	1	1	1	0x0F	Reserved.
0x180	JTX_CLK_CNTL_1	1	0	0	0	0	1	1	1	0x87	Reserved.
0x181	JTX_CLK_CNTL_2	0	0	0	0	0	PLL N divider setting (in powers of 2) 000 = divide by 1 (Z = ÷5, default) 001 = divide by 2 (Z = ÷10) 010 = divide by 4 (Z = ÷20) 011 = divide by 8 (Z = ÷40) 100 = divide by 16 (Z = ÷80) 101 = reserved 110 = reserved 111 = reserved		0x00	PLL N divider setting (Z) (global).	
0x182	PLL_STARTUP	PLL auto-configure 0 = disable (default) 1 = enable	0	0	0	0	0	1	0	0x02	PLL control (global).
0x183	RESERVED_183	0	0	0	0	0	1	1	1	0x07	Reserved.
0x184	RESERVED_184	0	0	0	0	0	0	0	0	0x00	Reserved.

## AD9671

## Data Sheet

Addr. (Hex)	Register Name	Bit 7 (MSB)	Bit 6	Bit 5	Bit 4	Bit 3	Bit 2	Bit 1	Bit 0 (LSB)	Default Value	Comments
0x186	DATA_VALID_RESYNC	1	0	1	0	One time data resync with JESD204B clock after TX_TRIG 0: disable resync 1: enable resync (default)	Continuous data resync with JESD204B clock 0: disable resync 1: enable resync (default)	One time SYSREF resync with JESD204B clock after TX_TRIG 0: disable resync 1: enable resync (default)	Continuous SYSREF resync with JESD204B clock 0: disable resync (default) 1: enable resync	0xAE	Data and SYSREF resync.
0x188	START_CODE_EN	0	0	0	0	0	0	0	Start code identifier 0 = disable 1 = enable (default)	0x01	Enable start code identifier (global).
0x189	RESERVED_189	0	0	0	0	0	0	0	0	0x00	Reserved.
0x18A	RESERVED_18A	0	0	0	0	0	0	0	0	0x00	Reserved.
0x18B	START_CODE_MSB	0	0	1	0	0	1	1	1	0x27	Start code MSB (global).
0x18C	START_CODE_LSB	0	1	1	1	0	0	1	0	0x72	Start code LSB (global).
0x190	FRAME_SIZE_MSB	X	X	X	Auto-matically set frame size 0 = disable 1 = enable (default)	X	X	X	X	0x10	Automatically set frame size (global).
0x191	RESERVED_191	0	0	0	0	0	0	0	0	0x00	Reserved.
0x192	RESERVED_192	0	0	0	1	1	0	0	0	0x18	Reserved.
0x193	RESERVED_193	0	0	0	0	0	0	0	0	0x00	Reserved.
0x194	RESERVED_194	0	0	0	1	1	1	0	0	0x1C	Reserved.
0x195	RESERVED_195	0	0	0	0	0	0	0	0	0x00	Reserved.
0x196	RESERVED_196	0	0	0	1	1	0	0	0	0x18	Reserved.
0x197	RESERVED_197	0	0	0	0	0	0	0	0	0x00	Reserved.
0x198	RESERVED_198	0	0	0	0	0	0	0	0	0x00	Reserved.
0x199	SAMPLE_CLOCK_COUNTER	SERDES clock counter 0 = disable (default) 1 = enable	0	0	0	0	0	0	0	0x00	Enables automatic SERDES sample clock counter.
0x19A	RESERVED_19A	0	0	0	0	0	0	0	0	0x00	Reserved.
0x19B	RESERVED_19B	0	1	1	1	0	0	0	0	0x70	Reserved.

## Data Sheet

AD9671

Addr. (Hex)	Register Name	Bit 7 (MSB)	Bit 6	Bit 5	Bit 4	Bit 3	Bit 2	Bit 1	Bit 0 (LSB)	Default Value	Comments
0x19C	JTX_FRAME_SIZE	X	X	X	Set frame size automatically 0 = disable 1 = enable (default)	X	X	0	0	0x10	Automatically set JESD204B frame size (global).
0x19D	RESERVED_19D	0	0	0	0	0	0	0	0	0x00	Reserved.
0x19E	RESERVED_19E	0	0	0	1	0	0	0	0	0x10	Reserved.
Coefficient Registers											
0x1000 to 0x1FFF	Coefficient memory	256 × 112 bits								0x00	Global.
Profile Memory Registers											
0xF00 to 0xFFF	Profile memory	32 × 64 bits								0x00	Global.

**MEMORY MAP REGISTER DESCRIPTIONS**

For more information about the SPI memory map and other functions, consult the [AN-877 Application Note, Interfacing to High Speed ADCs via SPI](#).

**Update (Register 0x0FF)**

All registers except Register 0x002 are updated as soon as they are written. Writing to Register 0x0FF (the value written is don't care) initializes and updates the speed mode (Address 0x002) and resets all other registers to their default values (analog and ADC registers only; not the JESD204B registers, Register 0x000, or Register 0x002). Set the speed mode in Register 0x002 and write to Register 0x0FF at the beginning of the setup of the SPI writes after the device is powered up to avoid rewriting other registers after Register 0x0FF is written.

**Profile Index and Software TX\_TRIG (Register 0x10C)**

The vector profile is selected using the profile index in Register 0x10C, Bits[4:0]. The software TX\_TRIG control in Bit 5 generates a TX\_TRIG signal internal to the device. This signal is asynchronous to the ADC sample clock. Therefore, do not use this signal to align the data output, reset the digital demodulator and decimator, or initiate advanced power mode across multiple devices in the system. The external pin-driven TX\_TRIG± control is recommended for systems that require synchronization of these features across multiple [AD9671](#) devices.

OUTLINE DIMENSIONS

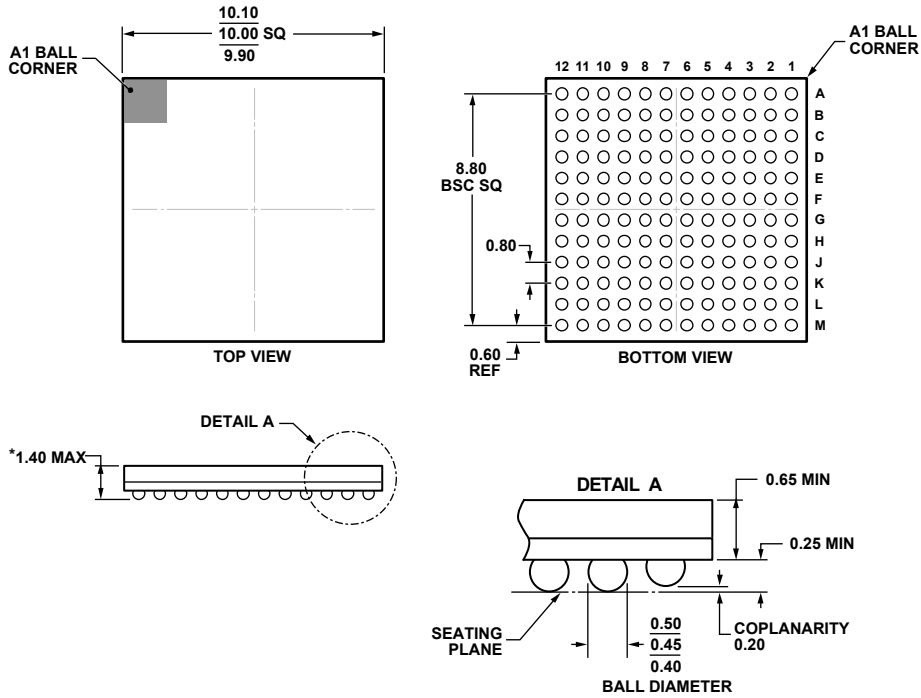

\*COMPLIANT WITH JEDEC STANDARDS MO-275-EEAB-1 WITH EXCEPTION TO PACKAGE HEIGHT.

10-21-2010-B

Figure 62. 144-Ball Chip Scale Package, Ball Grid Array [CSP\_BGA] (BC-144-1)  
Dimensions shown in millimeters

ORDERING GUIDE

Model <sup>1</sup>	Temperature Range	Package Description	Package Option
AD9671KBCZ	0°C to 85°C	144-Ball Chip Scale Package, Ball Grid Array [CSP_BGA]	BC-144-1
AD9671EBZ		Evaluation Board	

<sup>1</sup> Z = RoHs Compliant Part.

## OUR CERTIFICATE

DiGi provide top-quality products and perfect service for customer worldwide through standardization, technological innovation and continuous improvement. DiGi through third-party certification, we strictly control the quality of products and services. Welcome your RFQ to

Email: [Info@DiGi-Electronics.com](mailto:Info@DiGi-Electronics.com)



Tel: +00 852-30501935

RFQ Email: [Info@DiGi-Electronics.com](mailto:Info@DiGi-Electronics.com)

DiGi is a global authorized distributor of electronic components.