

# ADM8642T100ACBZ-R7 Datasheet

[www.digi-electronics.com](http://www.digi-electronics.com)

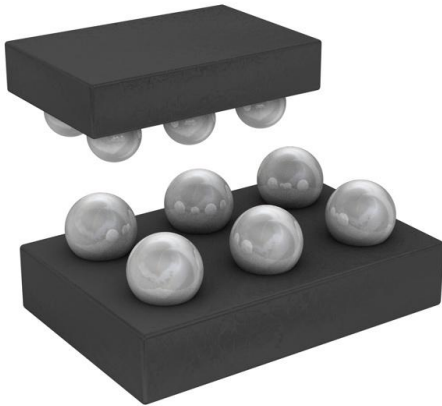

<https://www.DiGi-Electronics.com>

DiGi Electronics Part Number	ADM8642T100ACBZ-R7-DG
Manufacturer	<a href="#">Analog Devices Inc.</a>
Manufacturer Product Number	ADM8642T100ACBZ-R7
Description	IC SUPERVISOR 1 CHANNEL 6WLCSP
Detailed Description	Supervisor Open Drain or Open Collector 1 Channel 6-WLCSP (0.96x1.46)



Tel: +00 852-30501935

RFQ Email: [Info@DiGi-Electronics.com](mailto:Info@DiGi-Electronics.com)

DiGi is a global authorized distributor of electronic components.

## Purchase and inquiry

Manufacturer Product Number:

ADM8642T100ACBZ-R7

Series:

-

DiGi-Electronics Programmable:

Not Verified

Number of Voltages Monitored:

1

Output:

Open Drain or Open Collector

Reset Timeout:

-

Mounting Type:

Surface Mount

Supplier Device Package:

6-WLCSP (0.96x1.46)

Manufacturer:

Analog Devices Inc.

Product Status:

Active

Type:

Voltage Detector

Voltage - Threshold:

1V

Reset:

-

Operating Temperature:

-40°C ~ 85°C (TA)

Package / Case:

6-WFBGA, WLCSP

Base Product Number:

ADM8642

## Environmental & Export classification

RoHS Status:

ROHS3 Compliant

REACH Status:

REACH Unaffected

HTSUS:

8542.39.0001

Moisture Sensitivity Level (MSL):

1 (Unlimited)

ECCN:

EAR99



# Ultralow Power Voltage Detector

Data Sheet

**ADM8641/ADM8642**

## FEATURES

Ultralow power consumption with  $I_{CC} = 92 \text{ nA}$  (typical)

Precision, low voltage monitoring

Pretrimmed voltage monitoring threshold options

10 options from 2 V to 4.63 V for the **ADM8641**

20 options from 0.5 V to 1.9 V for the **ADM8642**

$\pm 1.3\%$  threshold accuracy over full temperature range

Output disable input

23  $\mu\text{s}$  to 26  $\mu\text{s}$  typical propagation delay

Open-drain type output

Power supply glitch immunity

Available in a 1.46 mm  $\times$  0.96 mm WLCSP

Operational temperature range:  $-40^\circ\text{C}$  to  $+85^\circ\text{C}$

## APPLICATIONS

Portable/battery-operated equipment

Microprocessor systems

Energy metering

Energy harvesting

## GENERAL DESCRIPTION

The **ADM8641** and **ADM8642** are simple voltage detectors suitable for use in general-purpose applications. The ultralow power consumption of these devices makes them suitable for power efficiency sensitive systems, such as battery-powered portable devices and energy meters.

The factory preset detection thresholds from 0.5 V to 4.63 V with  $\pm 1.2\%$  accuracy over the full temperature range enable the devices to monitor the node of interest accurately with direct contact. The  $\overline{\text{DIS}}$  input lets the user hold the output low regardless of the state of the input. Not all device options are

## FUNCTIONAL BLOCK DIAGRAMS

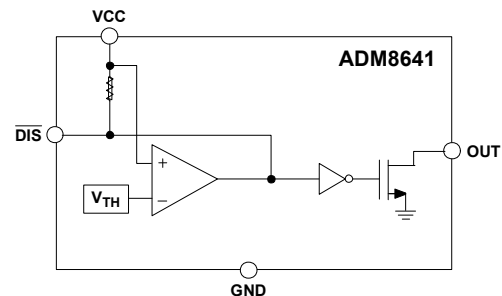

Figure 1. **ADM8641** Functional Block Diagram

12781-001

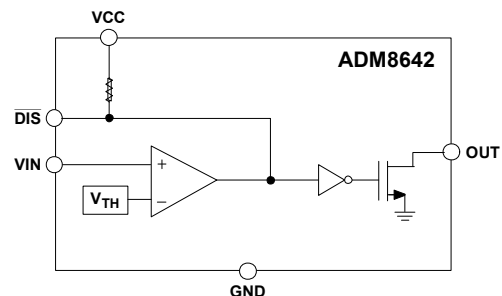

Figure 2. **ADM8642** Functional Block Diagram

12781-002

released for sale as standard models. See the Ordering Guide section for full information.

The **ADM8641** monitors the voltage using the VCC pin. The separate supply pin on the **ADM8642** allows it to have a lower detection threshold down to 0.5 V.

The **ADM8641** and **ADM8642** are available in a 6-ball, 1.46 mm  $\times$  0.96 mm WLCSP. These devices are specified over the  $-40^\circ\text{C}$  to  $+85^\circ\text{C}$  temperature range.

Rev. D

[Document Feedback](#)

Information furnished by Analog Devices is believed to be accurate and reliable. However, no responsibility is assumed by Analog Devices for its use, nor for any infringements of patents or other rights of third parties that may result from its use. Specifications subject to change without notice. No license is granted by implication or otherwise under any patent or patent rights of Analog Devices. Trademarks and registered trademarks are the property of their respective owners.

One Technology Way, P.O. Box 9106, Norwood, MA 02062-9106, U.S.A.  
Tel: 781.329.4700 ©2015–2021 Analog Devices, Inc. All rights reserved.  
[Technical Support](#) [www.analog.com](http://www.analog.com)

**TABLE OF CONTENTS**

Features.....	1	Theory of Operation .....	9
Applications .....	1	Voltage Monitoring Input .....	9
Functional Block Diagrams.....	1	VIN as an Adjustable Input .....	9
General Description .....	1	Transient Immunity .....	9
Revision History .....	2	Output.....	9
Specifications .....	3	Disable Input .....	9
Absolute Maximum Ratings .....	5	Device Model Options.....	10
Thermal Resistance .....	5	Outline Dimensions.....	11
ESD Caution.....	5	Ordering Guide .....	11
Pin Configurations and Function Descriptions.....	6		
Typical Performance Characteristics.....	7		
<b>REVISION HISTORY</b>			
<b>5/2021—Rev. C to Rev. D</b>		<b>1/2016—Rev. A to Rev. B</b>	
Added VCC Slew Rate Consideration Section.....	9	Changes to Ordering Guide.....	11
<b>1/2018—Rev. B to Rev. C</b>		<b>4/2015—Rev. 0 to Rev. A</b>	
Changes to General Description .....	1	Changes to Threshold Hysteresis Parameter, Table 1 .....	3
Added Note 1 to Table 1.....	3	<b>1/2015—Revision 0: Initial Version</b>	
Changed Out Output Parameter, Table 1 to Out Pin Output Parameter, Table 1, DIS Input Parameter, Table 1 to DIS Pin Input Parameter, Table 1.....	4		
Changed Device Options Section to Device Model Options Section.....	10		
Changes to Device Model Options Section .....	10		
Changes to Ordering Guide.....	11		

## SPECIFICATIONS

$V_{CC} = 2\text{ V to } 5.5\text{ V}$ ,  $V_{IN} < V_{CC} + 0.3\text{ V}$ ,  $T_A = -40^\circ\text{C to } +85^\circ\text{C}$ , unless otherwise noted. Typical values are at  $T_A = 25^\circ\text{C}$ .

Table 1.

Parameter	Symbol	Min	Typ	Max	Unit	Test Conditions/Comments
OPERATING VOLTAGE RANGE	$V_{CC}$					
ADM8641		0.9		5.5	V	Guarantees valid OUT output
ADM8642		2		5.5	V	Guarantees valid OUT output
		0.9			V	Guarantees OUT low
UNDERVOLTAGE LOCKOUT						ADM8642 only
Input Voltage Rising	$UVLO_{RISE}$			1.95	V	
Input Voltage Falling	$UVLO_{FALL}$	1.6			V	
Hysteresis	$UVLO_{HYS}$		90		mV	
INPUT CURRENT						
VCC Quiescent Current	$I_{CC}$		92	190	nA	$V_{CC} = 2\text{ V to } 5.5\text{ V}$ , OUT pulled high
				110	nA	$T_A = 25^\circ\text{C}$ , OUT pulled high
VIN Average Input Current	$I_{VIN}$		4	32	nA	$V_{IN} = 2\text{ V}$ , $V_{CC} = 2\text{ V}$
			4	8.5	nA	$V_{IN} = 2\text{ V}$ , $V_{CC} = 5.5\text{ V}$
THRESHOLD VOLTAGE <sup>1</sup>	$V_{TH}$					Input falling
ADM8641		$V_{TH} - 1.3\%$	$V_{TH}$	$V_{TH} + 1.3\%$	V	See Table 6
ADM8642		$V_{TH} - 1.3\%$	$V_{TH}$	$V_{TH} + 1.3\%$	V	See Table 7, $V_{TH} \geq 1.2\text{ V}$
		$V_{TH} - 1.4\%$	1.1	$V_{TH} + 1.4\%$	V	1.1 V threshold option
		$V_{TH} - 1.6\%$	1	$V_{TH} + 1.6\%$	V	1 V threshold option
		$V_{TH} - 1.6\%$	0.95	$V_{TH} + 1.6\%$	V	0.95 V threshold option
		$V_{TH} - 1.7\%$	0.9	$V_{TH} + 1.7\%$	V	0.9 V threshold option
		$V_{TH} - 1.8\%$	0.85	$V_{TH} + 1.8\%$	V	0.85 V threshold option
		$V_{TH} - 1.8\%$	0.8	$V_{TH} + 1.8\%$	V	0.8 V threshold option
		$V_{TH} - 1.9\%$	0.75	$V_{TH} + 1.9\%$	V	0.75 V threshold option
		$V_{TH} - 1.9\%$	0.7	$V_{TH} + 1.9\%$	V	0.7 V threshold option
		$V_{TH} - 2.0\%$	0.65	$V_{TH} + 2.0\%$	V	0.65 V threshold option
		$V_{TH} - 2.1\%$	0.6	$V_{TH} + 2.1\%$	V	0.6 V threshold option
		$V_{TH} - 2.1\%$	0.55	$V_{TH} + 2.1\%$	V	0.55 V threshold option
		$V_{TH} - 2.2\%$	0.5	$V_{TH} + 2.2\%$	V	0.5 V threshold option
THRESHOLD HYSTERESIS	$V_{HYS}$					
ADM8641			$0.9\% \times V_{TH}$		V	
ADM8642			$0.9\% \times V_{TH}$		V	$V_{TH} > 1\text{ V}$
			10.3		mV	$V_{TH} \leq 1\text{ V}$
PROPAGATION DELAY						
ADM8641 VCC to OUT	$t_{PD\_VCC}$	18	26	37	$\mu\text{s}$	$V_{CC}$ falling with $V_{TH} \times 10\%$ overdrive
		20.5	36	57	$\mu\text{s}$	$V_{CC}$ rising with $V_{TH} \times 10\%$ overdrive
ADM8642 VIN to OUT	$t_{PD\_VIN}$	13.5	23	35	$\mu\text{s}$	$V_{IN}$ falling with $V_{TH} \times 10\%$ overdrive
		22	39.5	61	$\mu\text{s}$	$V_{IN}$ rising with $V_{TH} \times 10\%$ overdrive
INPUT GLITCH REJECTION						
ADM8641 VCC Glitch Rejection	$t_{GR\_VCC}$		23		$\mu\text{s}$	$V_{CC}$ falling with $V_{TH} \times 10\%$ overdrive
			35		$\mu\text{s}$	$V_{CC}$ rising with $V_{TH} \times 10\%$ overdrive
ADM8642 VIN Glitch Rejection	$t_{GR\_VIN}$		21		$\mu\text{s}$	$V_{IN}$ falling with $V_{TH} \times 10\%$ overdrive
			38		$\mu\text{s}$	$V_{IN}$ rising with $V_{TH} \times 10\%$ overdrive

## ADM8641/ADM8642

## Data Sheet

Parameter	Symbol	Min	Typ	Max	Unit	Test Conditions/Comments
OUT PIN OUTPUT						
Output Voltage Low	$V_{OUT\_OL}$			0.4	V	$V_{CC} > 4.25\text{ V}$ , $I_{SINK} = 6.5\text{ mA}$
				0.4	V	$V_{CC} > 2.5\text{ V}$ , $I_{SINK} = 6\text{ mA}$
				0.4	V	$V_{CC} > 1.2\text{ V}$ , $I_{SINK} = 4.6\text{ mA}$
Leakage Current				0.4	V	$V_{CC} > 0.9\text{ V}$ , $I_{SINK} = 0.9\text{ mA}$
				5	nA	$V_{OUT} = V_{CC} = 5.5\text{ V}$
DIS PIN INPUT						
$V_{IL}$				0.4	V	
$V_{IH}$		0.9			V	
$\overline{\text{DIS}}$ Glitch Rejection			0.4		$\mu\text{s}$	
$\overline{\text{DIS}}$ to OUT Delay	$t_{D\_DIS1}$		0.65		$\mu\text{s}$	$\overline{\text{DIS}}$ falling
$\overline{\text{DIS}}$ Pull-Up Resistance		0.5	0.6	0.82	$M\Omega$	

<sup>1</sup>Not all device options are released for sale as standard models. See the Ordering Guide section for full information.

## ABSOLUTE MAXIMUM RATINGS

Table 2.

Parameter	Rating
VCC	-0.3 V to +6 V
OUT	-0.3 V to +6 V
VIN	-0.3 V to +6 V
DIS	-0.3 V to $V_{CC} + 0.3$ V
Input/Output Current	10 mA
Storage Temperature Range	-40°C to +150°C
Operating Temperature Range	-40°C to +85°C

Stresses at or above those listed under Absolute Maximum Ratings may cause permanent damage to the product. This is a stress rating only; functional operation of the product at these or any other conditions above those indicated in the operational section of this specification is not implied. Operation beyond the maximum operating conditions for extended periods may affect product reliability.

## THERMAL RESISTANCE

$\theta_{JA}$  is specified for a device soldered on an FR4 board with a minimum footprint.

Table 3.

Package Type	$\theta_{JA}$	Unit
6-Ball WLCSP	105.6	°C/W

## ESD CAUTION



**ESD (electrostatic discharge) sensitive device.** Charged devices and circuit boards can discharge without detection. Although this product features patented or proprietary protection circuitry, damage may occur on devices subjected to high energy ESD. Therefore, proper ESD precautions should be taken to avoid performance degradation or loss of functionality.

## PIN CONFIGURATIONS AND FUNCTION DESCRIPTIONS

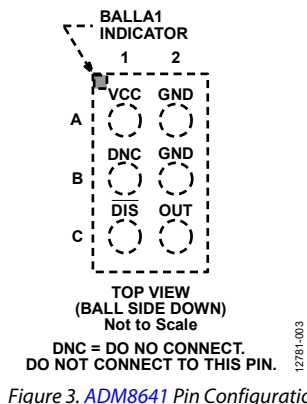
Table 4. *ADM8641* Pin Function Descriptions

Pin No.	Mnemonic	Description
A1	VCC	Power Supply Input. The voltage on the VCC pin is monitored on the <i>ADM8641</i> . It is recommended to place a 0.1 $\mu$ F decoupling capacitor between the VCC pin and the GND pin.
A2	GND	Ground. Both GND pins on the <i>ADM8641</i> must be grounded.
B1	DNC	Do Not Connect. Do not connect to this pin.
B2	GND	Ground. Both GND pins on the <i>ADM8641</i> must be grounded.
C1	$\overline{\text{DIS}}$	Active Low Output Disable Input.
C2	OUT	Open-Drain Detector Output.

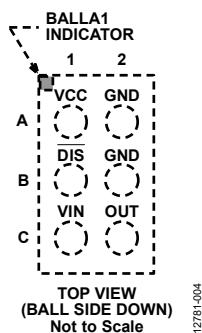
Table 5. *ADM8642* Pin Function Descriptions

Pin No.	Mnemonic	Description
A1	VCC	Power Supply Input. The voltage on the VCC pin is not monitored on the <i>ADM8642</i> . It is recommended to place a 0.1 $\mu$ F decoupling capacitor between the VCC pin and the GND pin.
A2	GND	Ground. Both GND pins on the <i>ADM8642</i> must be grounded.
B1	$\overline{\text{DIS}}$	Active Low Output Disable Input.
B2	GND	Ground. Both GND pins on the <i>ADM8642</i> must be grounded.
C1	VIN	Low Voltage Monitoring Input. This separate supply input allows the <i>ADM8642</i> to monitor low voltages of 0.8 V on the VIN pin.
C2	OUT	Open-Drain Detector Output.



### TYPICAL PERFORMANCE CHARACTERISTICS

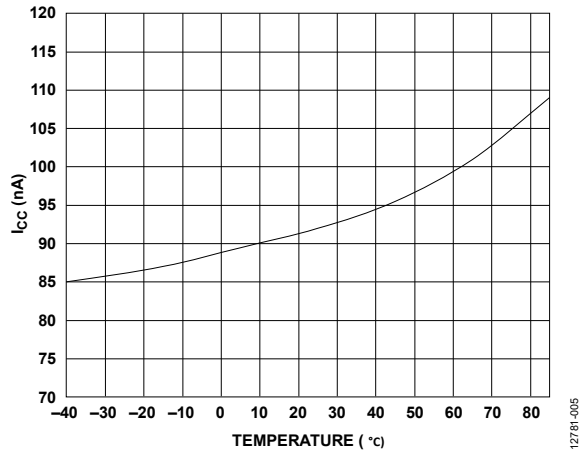

Figure 5. Supply Current ( $I_{CC}$ ) vs. Temperature

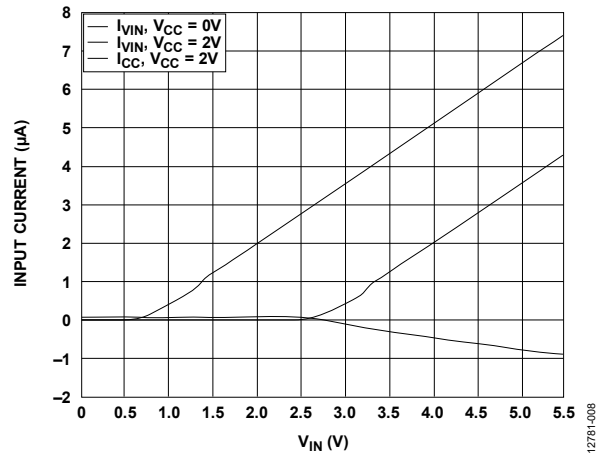

Figure 8.  $V_{IN}$  Pin and  $V_{CC}$  Pin Input Current vs.  $V_{IN}$

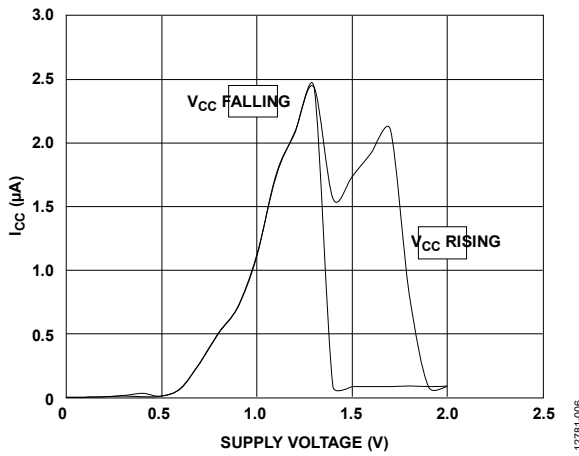

Figure 6. Supply Current ( $I_{CC}$ ) vs. Supply Voltage,  $V_{CC} < 2\text{ V}$

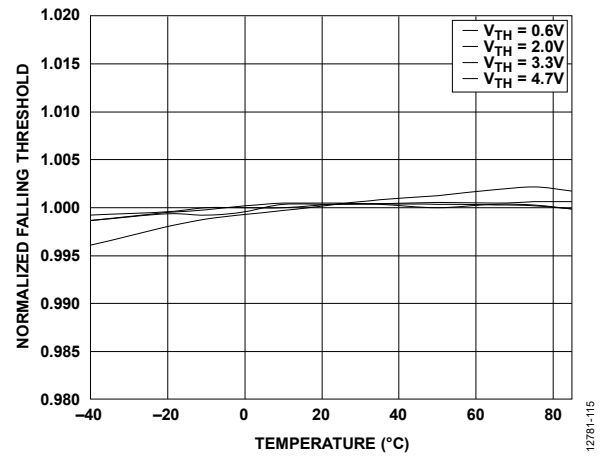

Figure 9. Normalized Falling Threshold vs. Temperature

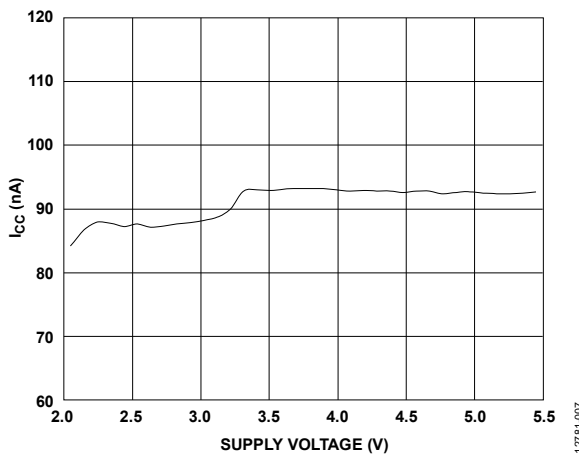

Figure 7. Supply Current ( $I_{CC}$ ) vs. Supply Voltage

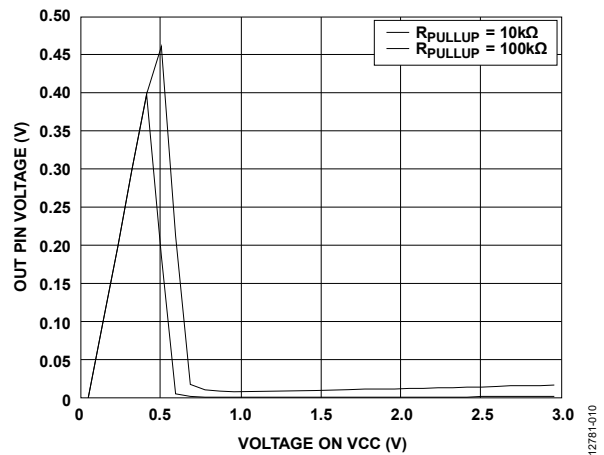

Figure 10.  $OUT$  Pin Voltage vs. Voltage on  $V_{CC}$  (with the  $OUT$  Pin Pulled up to the  $V_{CC}$  Pin Through  $R_{PULLUP}$ )

ADM8641/ADM8642

Data Sheet

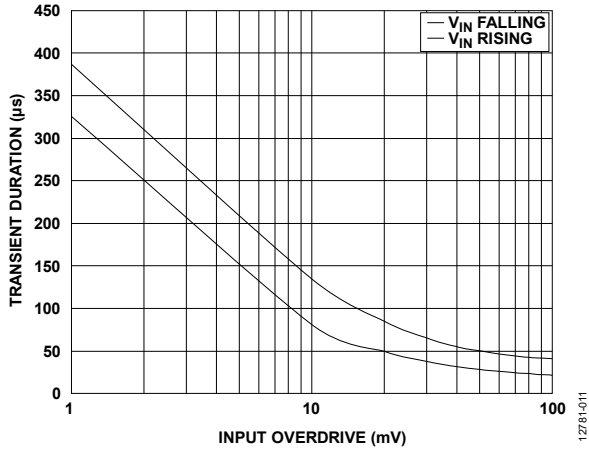

Figure 11. Maximum Transient Duration vs. Input Overdrive

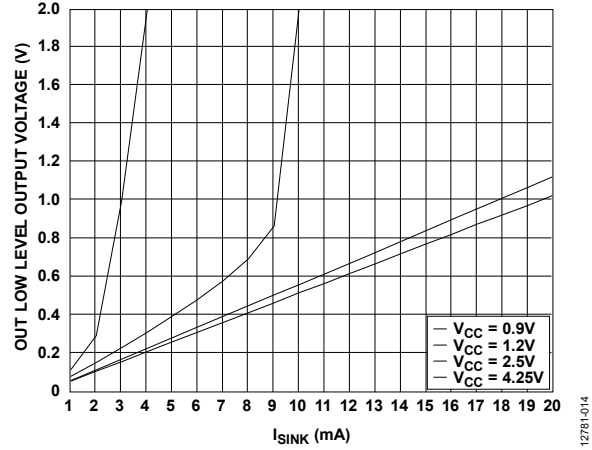

Figure 14. OUT Low Level Output Voltage vs. Sink Current ( $I_{SINK}$ )

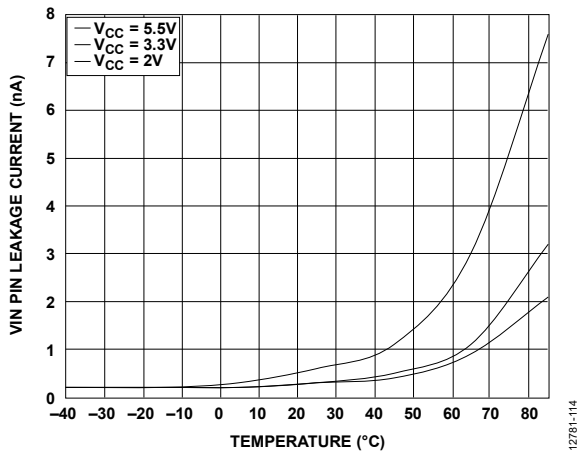

Figure 12. VIN Pin Leakage Current vs. Temperature

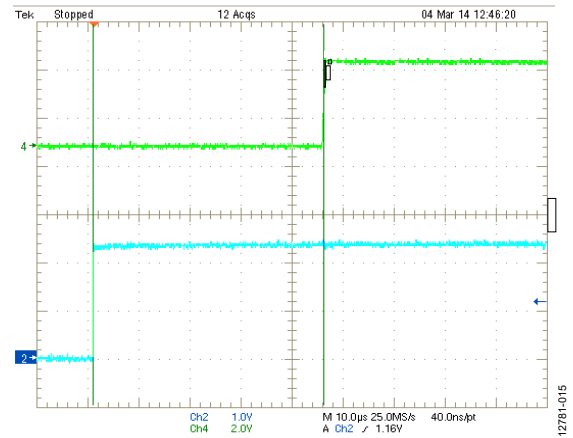

Figure 15. OUT Propagation Delay With VCC/VIN Rising

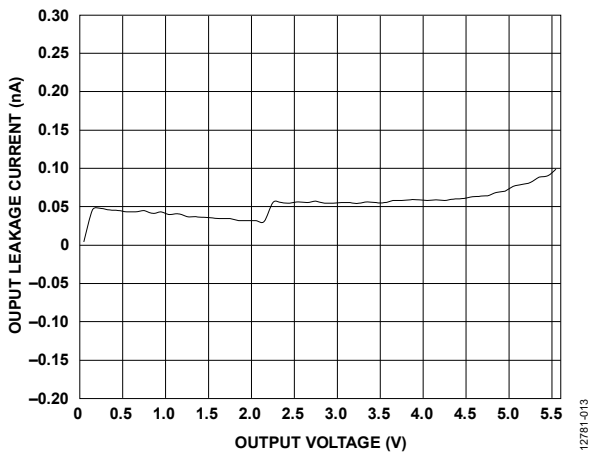

Figure 13. Output Leakage Current vs. Output Voltage

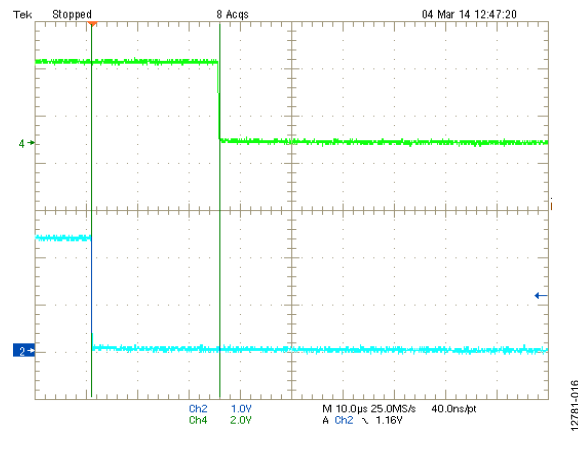

Figure 16. OUT Propagation Delay With VCC/VIN Falling

## THEORY OF OPERATION

The [ADM8641](#) and [ADM8642](#) ultralow power voltage detectors are especially suited for battery-powered applications due to the 190 nA quiescent current (maximum). The internal precision reference allows the user to monitor specific voltage levels accurately from 0.5 V to 4.63 V. These devices feature internal input hysteresis and an open-drain output. The output remains logic high after the monitored input is above the preset threshold. The output changes to logic low after the input voltage falls below the threshold. The devices keep the output in a logic low state whenever the supply voltage on the VCC pin is below the UVLO threshold. The output disable input can also keep the output low regardless of the status on the input.

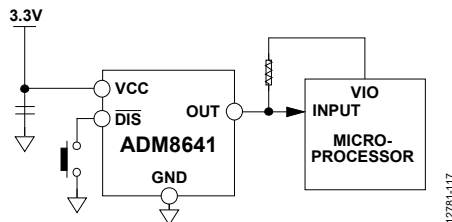

Figure 17. [ADM8641](#) Typical Application Circuit

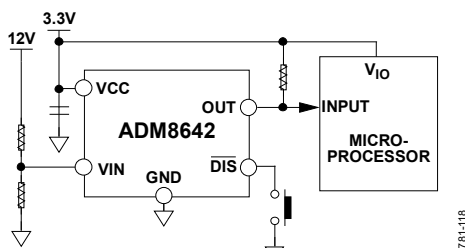

Figure 18. [ADM8642](#) Typical Application Circuit

### VOLTAGE MONITORING INPUT

The VCC pin on the [ADM8641](#) acts as both a device power input node and a voltage monitoring input node. The [ADM8642](#) uses separate pins for supply and voltage monitoring to achieve a low voltage monitoring threshold to 0.5 V. It is recommended to place a 0.1  $\mu$ F decoupling capacitor between the VCC pin and the GND pin.

#### VCC Slew Rate Consideration

A fast VCC ramp ( $\mu$ s range) on power-up can cause the device to behave in an irregular manner. In applications where a high slew rate on VCC is possible, for example, powering up using a battery pack, it is recommended that an RC filter is used to reduce the slew rate. RC combinations of 3.3 k $\Omega$  + 2.2  $\mu$ F and 1 k $\Omega$  + 10  $\mu$ F have been tested and identified as safe options.

### VIN AS AN ADJUSTABLE INPUT

Due to the low leakage nature of the VIN pin, the [ADM8642](#) can be used as a device with an adjustable threshold. Use an external resistor divider circuit to program the desired voltage monitoring threshold based on the VIN threshold, as shown in Figure 19.

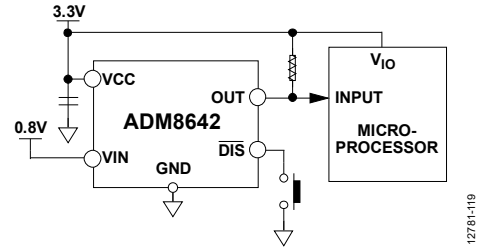

Figure 19. [ADM8642](#) as an Adjustable Threshold Device

### TRANSIENT IMMUNITY

To avoid unnecessary output state changes caused by fast power supply transients, an input glitch filter is added to the VCC pin of the [ADM8641](#) and the VIN pin of the [ADM8642](#) to filter out the transient glitches on these pins.

Figure 11 shows the comparator overdrive (that is, the maximum magnitude of positive and negative going pulses with respect to the typical threshold) vs. the pulse duration without changing the state of the output.

### OUTPUT

Both the [ADM8641](#) and [ADM8642](#) voltage detectors have an open-drain output. For the [ADM8641](#), the state of the output is guaranteed to be valid as soon as VCC rises above 0.9 V. For the [ADM8642](#), the output is guaranteed to be logic low from when VCC = 0.9 V to when the device exits ULVO.

When the monitored voltage falls below its associated threshold, the OUT pin asserts low after 23  $\mu$ s to 26  $\mu$ s (typical). When the monitored voltage rises above the threshold plus hysteresis, the OUT pin asserts high after 36  $\mu$ s to 39.5  $\mu$ s (typical).

### DISABLE INPUT

The [ADM8641/ADM8642](#) feature a disable input ( $\overline{\text{DIS}}$ ). Drive the  $\overline{\text{DIS}}$  pin low to assert the output low. The  $\overline{\text{DIS}}$  input has a 0.6 M $\Omega$  internal pull-up resistor so that the input is always high when unconnected. To drive the  $\overline{\text{DIS}}$  input, use an external signal or a push-button switch to ground; debounce circuitry is integrated on-chip for this purpose. Noise immunity is provided on the  $\overline{\text{DIS}}$  input, and fast, negative going transients of up to 0.4  $\mu$ s (typical) are ignored. If required, a 0.1  $\mu$ F capacitor between the  $\overline{\text{DIS}}$  pin and ground provides additional noise immunity.

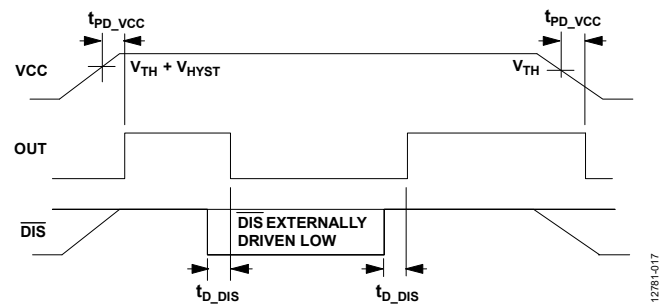

Figure 20.  $\overline{\text{DIS}}$  Input Timing

## DEVICE MODEL OPTIONS

The ADM8641/ADM8642 include many device options, however, not all options are released for sale. Released options are called standard models and are listed in the Ordering Guide section. The [Simple Reset Supervisory IC](#) page also offers a list

of standard models. Contact a sales representative for information on nonstandard models and be aware that samples and production units have long lead times.

**Table 6. ADM8641 V<sub>CC</sub> Threshold (V<sub>TH</sub>) Options (T<sub>A</sub> = -40°C to +85°C)**

Threshold Number	Min	Typ	Max	Unit
200	1.974	2	2.026	V
220	2.171	2.2	2.229	V
232	2.290	2.32	2.350	V
263	2.596	2.63	2.664	V
280	2.764	2.8	2.836	V
293	2.892	2.93	2.968	V
300	2.961	3	3.039	V
308	3.040	3.08	3.120	V
440	4.343	4.4	4.457	V
463	4.570	4.63	4.690	V

**Table 7. ADM8642 V<sub>IN</sub> Threshold (V<sub>TH</sub>) Options (T<sub>A</sub> = -40°C to +85°C)**

Threshold Number	Min	Typ	Max	Unit
050	0.489	0.5	0.511	V
055	0.538	0.55	0.562	V
060	0.588	0.6	0.612	V
065	0.637	0.65	0.663	V
070	0.686	0.7	0.714	V
075	0.736	0.75	0.764	V
080	0.785	0.8	0.815	V
085	0.835	0.85	0.865	V
090	0.885	0.9	0.915	V
095	0.935	0.95	0.965	V
100	0.984	1	1.016	V
110	1.084	1.1	1.116	V
120	1.184	1.2	1.216	V
130	1.283	1.3	1.317	V
140	1.382	1.4	1.418	V
150	1.481	1.5	1.520	V
160	1.579	1.6	1.621	V
170	1.678	1.7	1.722	V
180	1.777	1.8	1.823	V
190	1.875	1.9	1.925	V

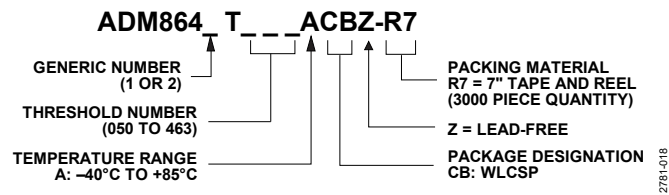

Figure 21. Ordering Code Structure

## OUTLINE DIMENSIONS

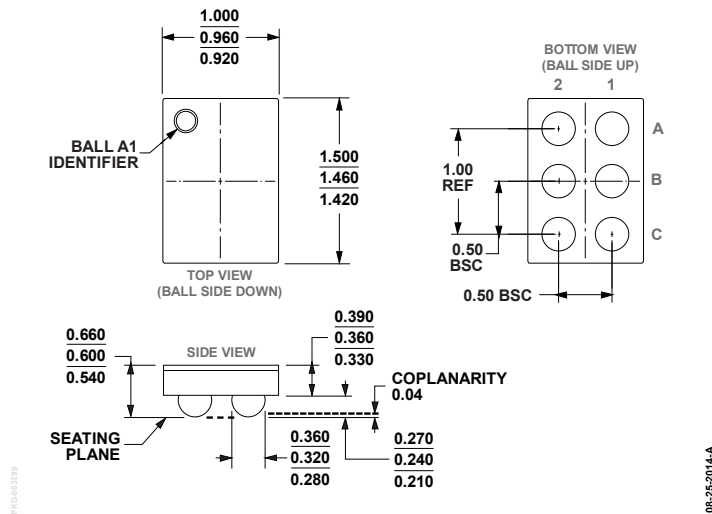

Figure 22. 6-Ball Wafer Level Chip Scale Package [WLCSP]  
(CB-6-17)  
Dimensions shown in millimeters

## ORDERING GUIDE

Model <sup>1, 2, 3</sup>	Temperature Range	Threshold Voltage (V)	Package Description	Package Option	Marking Code
ADM8641T263ACBZ-R7	-40°C to +85°C	2.63	6-Ball WLCSP	CB-6-17	DT
ADM8642T100ACBZ-R7	-40°C to +85°C	1.0	6-Ball WLCSP	CB-6-17	DU
ADM8641-EVALZ			Evaluation Board		
ADM8642-EVALZ			Evaluation Board		

<sup>1</sup> Z = RoHS Compliant Part.

<sup>2</sup> ADM8641/ADM8642 include many device options, however, not all options are released for sale. Released options are called standard models and are listed in the Ordering Guide. The [Simple Reset Supervisory IC](#) page also offers a list of standard models. Contact a sales representative for information on nonstandard models and be aware that samples and production units have long lead times.

<sup>3</sup> If ordering nonstandard models, complete the ordering code shown in Figure 21 by inserting the model number and threshold number.

## OUR CERTIFICATE

DiGi provide top-quality products and perfect service for customer worldwide through standardization, technological innovation and continuous improvement. DiGi through third-party certification, we stricly control the quality of products and services. Welcome your RFQ to

Email: [Info@DiGi-Electronics.com](mailto:Info@DiGi-Electronics.com)



Tel: +00 852-30501935

RFQ Email: [Info@DiGi-Electronics.com](mailto:Info@DiGi-Electronics.com)

DiGi is a global authorized distributor of electronic components.