

ADR02AR-REEL7 Datasheet

www.digi-electronics.com

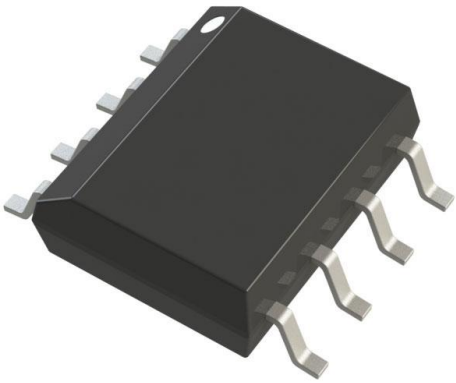

<https://www.DiGi-Electronics.com>

DiGi Electronics Part Number	ADR02AR-REEL7-DG
Manufacturer	Analog Devices Inc.
Manufacturer Product Number	ADR02AR-REEL7
Description	IC VREF SERIES 0.1% 8SOIC
Detailed Description	Series Voltage Reference IC Fixed 5V V \pm 0.1% 10 mA 8-SOIC

This model ADR02AR-REEL7 is available at DiGi Electronics.

DiGi Electronics offers a global database of semiconductor and electronic component datasheets.

We welcome your inquiries regarding pricing, lead time, or other product-related questions.

 [Request a Quote](#)

 [Datasheet Search](#)



Tel: +00 852-30501935

RFQ Email: Info@DiGi-Electronics.com

DiGi is a global authorized distributor of electronic components.

Purchase and inquiry

Manufacturer Product Number:

ADR02AR-REEL7

Series:

-

Reference Type:

Series

Voltage - Output (Min/Fixed):

5V

Tolerance:

±0.1%

Noise - 0.1Hz to 10Hz:

10µVp-p

Voltage - Input:

7V ~ 36V

Operating Temperature:

-40°C ~ 125°C (TA)

Package / Case:

8-SOIC (0.154", 3.90mm Width)

Base Product Number:

ADR02

Manufacturer:

Analog Devices Inc.

Product Status:

Obsolete

Output Type:

Fixed

Current - Output:

10 mA

Temperature Coefficient:

10ppm/°C

Noise - 10Hz to 10kHz:

-

Current - Supply:

1mA

Mounting Type:

Surface Mount

Supplier Device Package:

8-SOIC

Environmental & Export classification

Moisture Sensitivity Level (MSL):

1 (Unlimited)

HTSUS:

8542.39.0001

ECCN:

EAR99



Ultracompact, Precision 10.0 V/5.0 V/2.5 V/3.0 V Voltage References

Data Sheet

ADR01/ADR02/ADR03/ADR06

FEATURES

Ultracompact SC70 and TSOT packages

Low temperature coefficient

8-lead SOIC: 3 ppm/°C typical

5-lead SC70: 9 ppm/°C maximum

5-lead TSOT: 9 ppm/°C maximum

Initial accuracy ±0.1%

No external capacitor required

Low noise 10 µV p-p, 0.1 Hz to 10.0 Hz (ADR02)

Wide operating range

ADR01: 12.0 V to 36.0 V

ADR02: 7.0 V to 36.0 V

ADR03: 4.5 V to 36.0 V

ADR06: 5.0 V to 36.0 V

High output current 10 mA

Wide temperature range: -40°C to +125°C

ADR01/ADR02/ADR03 pin compatible to industry-standard REF01/REF02/REF03

ADR01, ADR02, ADR03 and ADR06 SOIC (A grade) qualified for automotive applications

APPLICATIONS

Precision data acquisition systems

High resolution converters

Industrial process control systems

Precision instruments

Auto battery monitoring

PCMCIA cards

GENERAL DESCRIPTION

The ADR01, ADR02, ADR03, and ADR06 are precision 10.0 V, 5.0 V, 2.5 V, and 3.0 V, respectively, band gap voltage references featuring high accuracy, high stability, and low power consumption. The devices are housed in tiny, 5-lead SC70 and TSOT packages, as well as in 8-lead SOIC version. The SOIC version of the ADR01, ADR02, and ADR03 are drop-in replacements¹ to the industry-standard REF01, REF02, and REF03. The small footprint and wide operating range make the ADR01, ADR02, ADR03, and ADR06 references ideally suited for general-purpose and space-constrained applications.

With an external buffer and a simple resistor network, the TEMP pin can be used for temperature sensing and approximation. A TRIM pin is provided on the devices for fine adjustment of the output voltage.

¹ ADR01, ADR02, and ADR03 are component level compatible with REF01, REF02, and REF03, respectively. No guarantees for system level compatibility are implied. SOIC versions of ADR01, ADR02, and ADR03 are pin-to-pin compatible with the 8-lead SOIC versions of the REF01, REF02, REF03, respectively, with the additional temperature monitoring function.

Rev. 5

Document Feedback

Information furnished by Analog Devices is believed to be accurate and reliable. However, no responsibility is assumed by Analog Devices for its use, nor for any infringements of patents or other rights of third parties that may result from its use. Specifications subject to change without notice. No license is granted by implication or otherwise under any patent or patent rights of Analog Devices. Trademarks and registered trademarks are the property of their respective owners.

PIN CONFIGURATIONS

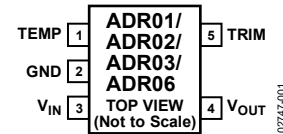
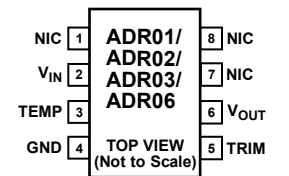

Figure 1. 5-Lead, SC70/TSOT Surface-Mount Packages



NOTES
1. NIC = NO INTERNAL CONNECT.

Figure 2. 8-Lead, SOIC Surface-Mount Package

The ADR01, ADR02, ADR03, and ADR06 are compact, low drift voltage references that provide a stable output voltage from a wide supply voltage range. The devices are available in 5-lead SC70 and TSOT packages and an 8-lead SOIC package with A, B, and C grade selections. All devices are specified over the extended industrial (-40°C to +125°C) temperature range. The ADR01, ADR02, ADR03, and ADR06 A grade in 8-lead SOIC are qualified for automotive applications.

Table 1. Selection Guide

Part Number	Output Voltage (V)
ADR01	10.0
ADR02	5.0
ADR03	2.5
ADR06	3.0

TABLE OF CONTENTS

Features	1
Applications.....	1
Pin Configurations	1
General Description	1
Revision History	2
Specifications.....	4
ADR01 Electrical Characteristics.....	4
ADR02 Electrical Characteristics.....	5
ADR03 Electrical Characteristics.....	6
ADR06 Electrical Characteristics.....	7
Absolute Maximum Ratings.....	8
Thermal Resistance	8
ESD Caution.....	8

REVISION HISTORY

12/2019—Rev. R to Rev. S

Changes to Features Section and General Description Section.....	1
Changes to Table 2.....	4
Changes to Table 3.....	5
Changes to Table 4.....	6
Changes to Table 5.....	7
Changes to Thermal Resistance Section.....	8
Changes to Figure 19 and Figure 20.....	11
Changes to Figure 21 and Figure 22.....	12
Replaced Figure 24	12
Added Figure 25 and Figure 26; Renumbered Sequentially	12
Added Figure 27.....	13
Change to Figure 34 and Figure 35	14
Moved Terminology Section.....	15
Changes to Terminology Section.....	15
Changes to Overview Section and Figure 38.....	16
Changes to Temperature Monitoring Section, Figure 40, Figure 41, and Figure 42	17
Changes to Figure 43 and Figure 45.....	18
Updated Outline Dimensions	19
Changes to ADR01 Ordering Guide and ADR02 Ordering Guide	20
Changes to ADR03 Ordering Guide and ADR06 Ordering Guide	21

1/2012—Rev. Q to Rev. R

Changes to Table 2.....	4
Changes to ADR01 Ordering Guide.....	190

11/2011—Rev. P to Rev. Q

Changes to General Description Section	1
Changes to Table 2.....	4

Typical Performance Characteristics	9
Terminology.....	15
Applications Information	16
Overview	16
Applying the ADR01/ADR02/ADR03/ADR06.....	16
Low Cost Current Source.....	17
Precision Current Source with Adjustable Output	17
Programmable 4 mA to 20 mA Current Transmitter.....	18
Precision Boosted Output Regulator	18
Outline Dimensions	19
Ordering Guides.....	20
Automotive Products.....	21

Changes to Table 3.....	5
Changes to Table 4.....	6
Changes to Table 5.....	7

10/2011 Rev. O to Rev. P

Changes to Features Section, Applications Section, and General Description Section.....	1
Changes to ADR01 Electrical Characteristics Section and Table 2.....	4
Changes to ADR02 Electrical Characteristics Section and Table 3.....	5
Changes to ADR03 Electrical Characteristics Section and Table 4.....	6
Changes to ADR06 Electrical Characteristics Section and Table 5.....	7
Changes to Ordering Guides	19
Changes to Automotive Products Section	20

10/2010—Rev. N to Rev. O

Deleted Negative Reference Section and Figure 38	16
Changes to ADR02 Ordering Guide.....	19

7/2010—Rev. M to Rev. N

Changes to Figure 2.....	1
Changes to ADR01 Ordering Guide.....	19
Added Automotive Products Section	20

4/2010—Rev. L to Rev. M

Changes to Features Section and General Description Section.....	1
Changes to Figure 41.....	17
Changes to Ordering Guides Section	19

Data Sheet

ADR01/ADR02/ADR03/ADR06

12/2008—Rev. K to Rev. L

Changes to Maximum Input Voltage.....	Universal
Removed Die Version	Universal
Changes to Table 2	3
Changes to Table 3	4
Changes to Table 4	5
Changes to Table 5	6
Deleted Table 6 and Figure 3	7
Changes to Terminology Section	8
Added Input and Output Capacitors Section	15

2/2008—Rev. J to Rev. K

Changes to Terminology Section	9
Changes to Ordering Guide.....	19

3/2007—Rev. I to Rev. J

Renamed Parameters and Definitions Section.....	9
Changes to Temperature Monitoring Section	15
Changes to Ordering Guide.....	19

7/2005—Rev. H to Rev. I

Changes to Table 5	7
Updated Outline Dimensions.....	19
Changes to Ordering Guide.....	19

12/2004—Rev. G to Rev. H

Changes to ADR06 Ordering Guide.....	20
--------------------------------------	----

9/2004—Rev. F to Rev. G

Changes to Table 2	4
Changes to Table 3	5
Changes to Table 4	6
Changes to Table 5	7
Changes to Ordering Guide.....	19

7/2004—Rev. E to Rev. F

Changes to ADR02 Electrical Characteristics, Table 2	4
Changes to Ordering Guide.....	19

2/2004—Rev. D to Rev. E

Added C grade.....	Universal
Changes to Outline Dimensions	19
Updated Ordering Guide	20

8/2003—Rev. C to Rev. D

Added ADR06	Universal
Change to Figure 27	13

6/2003—Rev. B to Rev. C

Changes to Features Section	1
Changes to General Description Section	1
Changes to Figure 2	1
Changes to Specifications Section	2
Addition of Dice Electrical Characteristics and Layout	6
Changes to Absolute Maximum Ratings Section	7
Updated SOIC (R-8) Outline Dimensions.....	19
Changes to Ordering Guide.....	20

2/2003—Rev. A to Rev. B

Added ADR03	Universal
Added TSOT-5 (UJ) Package.....	Universal
Updated Outline Dimensions.....	18

12/2002—Rev. 0 to Rev. A

Changes to Features Section	1
Changes to General Description	1
Table I Deleted.....	1
Changes to ADR01 Specifications	2
Changes to ADR02 Specifications	3
Changes to Absolute Maximum Ratings Section	4
Changes to Ordering Guide.....	4
Updated Outline Dimensions.....	12

SPECIFICATIONS

ADR01 ELECTRICAL CHARACTERISTICS

$V_{IN} = 12.0\text{ V to }36.0\text{ V}$, $V_{IN} = 12.0\text{ V to }24.0\text{ V}$ for ADR01WARZ, $T_A = 25^\circ\text{C}$, unless otherwise noted.

Table 2.

Parameter	Symbol	Test Conditions/Comments	Min	Typ	Max	Unit
OUTPUT VOLTAGE	V_O	A and C grades	9.990	10.000	10.010	V
		B grade	9.995	10.000	10.005	V
		ADR01WARZ	9.986	10.000	10.014	V
INITIAL ACCURACY	V_{OERR}	A and C grades	-10		+10	mV
			-0.1		+0.1	%
		B grade	-5		+5	mV
			-0.05		+0.05	%
		ADR01WARZ	-14		+14	mV
			-0.14		+0.14	%
TEMPERATURE COEFFICIENT	TCV_O	A grade, 8-lead SOIC, $-40^\circ\text{C} < T_A < +125^\circ\text{C}$		3	10	ppm/ $^\circ\text{C}$
		A grade, 5-lead TSOT, $-40^\circ\text{C} < T_A < +125^\circ\text{C}$			25	ppm/ $^\circ\text{C}$
		A grade, 5-lead SC70, $-40^\circ\text{C} < T_A < +125^\circ\text{C}$			25	ppm/ $^\circ\text{C}$
		B grade, 8-lead SOIC, $-40^\circ\text{C} < T_A < +125^\circ\text{C}$		1	3	ppm/ $^\circ\text{C}$
		B grade, 5-lead TSOT, $-40^\circ\text{C} < T_A < +125^\circ\text{C}$			9	ppm/ $^\circ\text{C}$
		B grade, 5-lead SC70, $-40^\circ\text{C} < T_A < +125^\circ\text{C}$			9	ppm/ $^\circ\text{C}$
		C grade, 8-lead SOIC, $-40^\circ\text{C} < T_A < +125^\circ\text{C}$		10	40	ppm/ $^\circ\text{C}$
DROPOUT VOLTAGE	V_{DO}		2			V
LINE REGULATION	$\Delta V_O/\Delta V_{IN}$	$V_{IN} = 12.0\text{ V to }36.0\text{ V}$, $V_{IN} = 12.0\text{ V to }26.0\text{ V}$ for ADR01WARZ, $-40^\circ\text{C} < T_A < +125^\circ\text{C}$		7	30	ppm/V
LOAD REGULATION	$\Delta V_O/\Delta I_{LOAD}$	Load current (I_{LOAD}) = 0 mA to 10 mA, $-40^\circ\text{C} < T_A < +125^\circ\text{C}$, $V_{IN} = 15.0\text{ V}$		40	70	ppm/mA
QUIESCENT CURRENT	I_{IN}	No load, $-40^\circ\text{C} < T_A < +125^\circ\text{C}$		0.65	1	mA
VOLTAGE NOISE	$e_{N\text{ p-p}}$	0.1 Hz to 10.0 Hz		20		$\mu\text{V p-p}$
				2		ppm p-p
VOLTAGE NOISE DENSITY	e_N	1 kHz		475		nV/ $\sqrt{\text{Hz}}$
TURN-ON SETTLING TIME	t_R			4		μs
LONG-TERM STABILITY ¹	ΔV_{OUT_LTD}	1000 hours		50		ppm
OUTPUT VOLTAGE HYSTERESIS	ΔV_{OUT_HYS}			70		ppm
RIPPLE REJECTION RATIO	RRR	Input frequency (f_{IN}) = 10 kHz		-75		dB
SHORT CIRCUIT TO GND	I_{SC}			30		mA
TEMPERATURE SENSOR	V_{TEMP}	Temperature Sensitivity		550		mV
			TCV_{TEMP}		1.96	

¹ The long-term stability specification is noncumulative. The drift in subsequent 1000 hour periods is significantly lower than in the first 1000 hour period.

ADR02 ELECTRICAL CHARACTERISTICS

$V_{IN} = 7.0\text{ V to }36.0\text{ V}$, $V_{IN} = 7.0\text{ V to }26.0\text{ V}$ for ADR02WARZ, $T_A = 25^\circ\text{C}$, unless otherwise noted.

Table 3.

Parameter	Symbol	Test Conditions/Comments	Min	Typ	Max	Unit
OUTPUT VOLTAGE	V_O	A and C grades	4.995	5.000	5.005	V
		B grade	4.997	5.000	5.003	V
INITIAL ACCURACY	V_{OERR}	A and C grades	-5		+5	mV
			-0.1		+0.1	%
		B grade	-3		+3	mV
			-0.06		+0.06	%
TEMPERATURE COEFFICIENT	TCV_O	A grade, 8-lead SOIC, $-40^\circ\text{C} < T_A < +125^\circ\text{C}$		3	10	ppm/ $^\circ\text{C}$
		A grade, 5-lead TSOT, $-40^\circ\text{C} < T_A < +125^\circ\text{C}$			25	ppm/ $^\circ\text{C}$
		A grade, 5-lead SC70, $-40^\circ\text{C} < T_A < +125^\circ\text{C}$			25	ppm/ $^\circ\text{C}$
		A grade, 5-lead SC70, $-55^\circ\text{C} < T_A < +125^\circ\text{C}$			30	ppm/ $^\circ\text{C}$
		B grade, 8-lead SOIC, $-40^\circ\text{C} < T_A < +125^\circ\text{C}$		1	3	ppm/ $^\circ\text{C}$
		B grade, 5-lead TSOT, $-40^\circ\text{C} < T_A < +125^\circ\text{C}$			9	ppm/ $^\circ\text{C}$
		B grade, 5-lead SC70, $-40^\circ\text{C} < T_A < +125^\circ\text{C}$			9	ppm/ $^\circ\text{C}$
		C grade, 8-lead SOIC, $-40^\circ\text{C} < T_A < +125^\circ\text{C}$		10	40	ppm/ $^\circ\text{C}$
DROPOUT VOLTAGE	V_{DO}		2			V
LINE REGULATION	$\Delta V_O/\Delta V_{IN}$	$V_{IN} = 7.0\text{ V to }36.0\text{ V}$, $V_{IN} = 7.0\text{ V to }26.0\text{ V}$ for ADR02WARZ, $-40^\circ\text{C} < T_A < +125^\circ\text{C}$		7	30	ppm/V
		$V_{IN} = 7.0\text{ V to }36.0\text{ V}$, $-55^\circ\text{C} < T_A < +125^\circ\text{C}$		7	40	ppm/V
LOAD REGULATION	$\Delta V_O/\Delta I_{LOAD}$	$I_{LOAD} = 0\text{ mA to }10\text{ mA}$, $-40^\circ\text{C} < T_A < +125^\circ\text{C}$, $V_{IN} = 10.0\text{ V}$		40	70	ppm/mA
		$I_{LOAD} = 0\text{ mA to }10\text{ mA}$, $-55^\circ\text{C} < T_A < +125^\circ\text{C}$, $V_{IN} = 10.0\text{ V}$		45	80	ppm/mA
QUIESCENT CURRENT	I_{IN}	No load, $-40^\circ\text{C} < T_A < +125^\circ\text{C}$		0.65	1	mA
VOLTAGE NOISE	$e_{N\text{ p-p}}$	0.1 Hz to 10.0 Hz		10		$\mu\text{V p-p}$
				2		ppm p-p
VOLTAGE NOISE DENSITY	e_N	1 kHz		240		nV/ $\sqrt{\text{Hz}}$
TURN-ON SETTLING TIME	t_R			4		μs
LONG-TERM STABILITY ¹	ΔV_{OUT_LTD}	1000 hours		50		ppm
OUTPUT VOLTAGE HYSTERESIS	ΔV_{OUT_HYS}	$-55^\circ\text{C} < T_A < +125^\circ\text{C}$		70		ppm
				80		ppm
RIPPLE REJECTION RATIO	RRR	$f_{IN} = 10\text{ kHz}$		-75		dB
SHORT CIRCUIT TO GND	I_{SC}			30		mA
TEMPERATURE SENSOR	V_{TEMP} TCV_{TEMP}	Voltage Output at TEMP Pin Temperature Sensitivity		550		mV
				1.96		mV/ $^\circ\text{C}$

¹ The long-term stability specification is noncumulative. The drift in subsequent 1000 hour periods is significantly lower than in the first 1000 hour period.

ADR03 ELECTRICAL CHARACTERISTICS

$V_{IN} = 4.5\text{ V to }36.0\text{ V}$, $V_{IN} = 4.5\text{ V to }26.0\text{ V}$ for ADR03WARZ, $T_A = 25^\circ\text{C}$, unless otherwise noted.

Table 4.

Parameter	Symbol	Test Conditions/Comments	Min	Typ	Max	Unit	
OUTPUT VOLTAGE	V_O	A and C grades	2.495	2.500	2.505	V	
		B grades	2.4975	2.5000	2.5025	V	
INITIAL ACCURACY	V_{OERR}	A and C grades	-5		+5	mV	
			-0.2		+0.2	%	
		B grades	-2.5		+2.5	mV	
			-0.1		+0.1	%	
TEMPERATURE COEFFICIENT	TCV_O	A grade, 8-lead SOIC, $-40^\circ\text{C} < T_A < +125^\circ\text{C}$		3	10	ppm/ $^\circ\text{C}$	
		A grade, 5-lead TSOT, $-40^\circ\text{C} < T_A < +125^\circ\text{C}$			25	ppm/ $^\circ\text{C}$	
		A grade, 5-lead SC70, $-40^\circ\text{C} < T_A < +125^\circ\text{C}$			25	ppm/ $^\circ\text{C}$	
		A grade, 5-lead SC70, $-55^\circ\text{C} < T_A < +125^\circ\text{C}$			30	ppm/ $^\circ\text{C}$	
		B grade, 8-lead SOIC, $-40^\circ\text{C} < T_A < +125^\circ\text{C}$		1	3	ppm/ $^\circ\text{C}$	
		B grade, 5-lead TSOT, $-40^\circ\text{C} < T_A < +125^\circ\text{C}$			9	ppm/ $^\circ\text{C}$	
		B grade, 5-lead SC70, $-40^\circ\text{C} < T_A < +125^\circ\text{C}$			9	ppm/ $^\circ\text{C}$	
		C grade, 8-lead SOIC, $-40^\circ\text{C} < T_A < +125^\circ\text{C}$			10	40	ppm/ $^\circ\text{C}$
		DROPOUT VOLTAGE	V_{DO}		2		
LINE REGULATION	$\Delta V_O/\Delta V_{IN}$	$V_{IN} = 4.5\text{ V to }36.0\text{ V}$, $V_{IN} = 4.5\text{ V to }26.0\text{ V}$ for ADR03WARZ, $-40^\circ\text{C} < T_A < +125^\circ\text{C}$		7	30	ppm/V	
		$V_{IN} = 4.5\text{ V to }36.0\text{ V}$, $-55^\circ\text{C} < T_A < +125^\circ\text{C}$		7	40	ppm/V	
LOAD REGULATION	$\Delta V_O/\Delta I_{LOAD}$	$I_{LOAD} = 0\text{ mA to }10\text{ mA}$, $-40^\circ\text{C} < T_A < +125^\circ\text{C}$, $V_{IN} = 7.0\text{ V}$		25	70	ppm/mA	
		$I_{LOAD} = 0\text{ mA to }10\text{ mA}$, $-55^\circ\text{C} < T_A < +125^\circ\text{C}$, $V_{IN} = 7.0\text{ V}$		45	80	ppm/mA	
QUIESCENT CURRENT	I_{IN}	No load, $-40^\circ\text{C} < T_A < +125^\circ\text{C}$		0.65	1	mA	
VOLTAGE NOISE	$e_{N\text{ p-p}}$	0.1 Hz to 10.0 Hz		5		$\mu\text{V p-p}$	
					2		ppm p-p
VOLTAGE NOISE DENSITY	e_N	1 kHz		115		nV/ $\sqrt{\text{Hz}}$	
TURN-ON SETTLING TIME	t_R			4		μs	
LONG-TERM STABILITY ¹	ΔV_{OUT_LTD}	1000 hours		50		ppm	
OUTPUT VOLTAGE HYSTERESIS	ΔV_{OUT_HYS}	$-55^\circ\text{C} < T_A < +125^\circ\text{C}$		70		ppm	
				80		ppm	
RIPPLE REJECTION RATIO	RRR	$f_{IN} = 10\text{ kHz}$		-75		dB	
SHORT CIRCUIT TO GND	I_{SC}			30		mA	
TEMPERATURE SENSOR	Voltage Output at TEMP Pin	V_{TEMP}		550		mV	
			Temperature Sensitivity	TCV_{TEMP}	1.96		mV/ $^\circ\text{C}$

¹ The long-term stability specification is noncumulative. The drift in subsequent 1000 hour periods is significantly lower than in the first 1000 hour period.

ADR06 ELECTRICAL CHARACTERISTICS

$V_{IN} = 5.0\text{ V}$ to 36.0 V , $V_{IN} = 5.0\text{ V}$ to 26.0 V for ADR06WARZ, $T_A = 25^\circ\text{C}$, unless otherwise noted.

Table 5.

Parameter	Symbol	Test Conditions/Comments	Min	Typ	Max	Unit
OUTPUT VOLTAGE	V_O	A and C grades	2.994	3.000	3.006	V
		B grade	2.997	3.000	3.003	V
INITIAL ACCURACY	V_{OERR}	A and C grades	-6		+6	mV
			-0.2		+0.2	%
		B grade	-3		+3	mV
			-0.1		+0.1	%
TEMPERATURE COEFFICIENT	TCV_O	A grade, 8-lead SOIC, $-40^\circ\text{C} < T_A < +125^\circ\text{C}$		3	10	ppm/ $^\circ\text{C}$
		A grade, 5-lead TSOT, $-40^\circ\text{C} < T_A < +125^\circ\text{C}$			25	ppm/ $^\circ\text{C}$
		A grade, 5-lead SC70, $-40^\circ\text{C} < T_A < +125^\circ\text{C}$			25	ppm/ $^\circ\text{C}$
		B grade, 8-lead SOIC, $-40^\circ\text{C} < T_A < +125^\circ\text{C}$		1	3	ppm/ $^\circ\text{C}$
		B grade, 5-lead TSOT, $-40^\circ\text{C} < T_A < +125^\circ\text{C}$			9	ppm/ $^\circ\text{C}$
		B grade, 5-lead SC70, $-40^\circ\text{C} < T_A < +125^\circ\text{C}$			9	ppm/ $^\circ\text{C}$
		C grade, 8-lead SOIC, $-40^\circ\text{C} < T_A < +125^\circ\text{C}$		10	40	ppm/ $^\circ\text{C}$
DROPOUT VOLTAGE	V_{DO}		2			V
LINE REGULATION	$\Delta V_O/\Delta V_{IN}$	$V_{IN} = 5.0\text{ V}$ to 36.0 V , $V_{IN} = 5.0\text{ V}$ to 26.0 V for ADR06WARZ, $-40^\circ\text{C} < T_A < +125^\circ\text{C}$		7	30	ppm/V
LOAD REGULATION	$\Delta V_O/\Delta I_{LOAD}$	$I_{LOAD} = 0\text{ mA}$ to 10 mA , $-40^\circ\text{C} < T_A < +125^\circ\text{C}$, $V_{IN} = 7.0\text{ V}$		40	70	ppm/mA
QUIESCENT CURRENT	I_{IN}	No load, $-40^\circ\text{C} < T_A < +125^\circ\text{C}$		0.65	1	mA
VOLTAGE NOISE	$e_{N\text{ p-p}}$	0.1 Hz to 10.0 Hz		6		$\mu\text{V p-p}$
				2		ppm p-p
VOLTAGE NOISE DENSITY	e_N	1 kHz		127		nV/ $\sqrt{\text{Hz}}$
TURN-ON SETTLING TIME	t_R			4		μs
LONG-TERM STABILITY ¹	ΔV_{OUT_LTD}	1000 hours		50		ppm
OUTPUT VOLTAGE HYSTERESIS	ΔV_{OUT_HYS}			70		ppm
RIPPLE REJECTION RATIO	RRR	$f_{IN} = 10\text{ kHz}$		-75		dB
SHORT CIRCUIT TO GND	I_{SC}			30		mA
TEMPERATURE SENSOR	Voltage Output at TEMP Pin	V_{TEMP}		550		mV
			Temperature Sensitivity	TCV_{TEMP}	1.96	

¹ The long-term stability specification is noncumulative. The drift in subsequent 1000 hour periods is significantly lower than in the first 1000 hour period.

ABSOLUTE MAXIMUM RATINGS

Ratings are at 25°C, unless otherwise noted.

Table 6.

Parameter	Rating
Supply Voltage	36.0 V
Output Short-Circuit Duration to GND	Indefinite
Temperature	
Storage Range	−65°C to +150°C
Operating Range	−40°C to +125°C
Junction Range	−65°C to +150°C
Lead (Soldering, 60 sec)	300°C

Stresses at or above those listed under Absolute Maximum Ratings may cause permanent damage to the product. This is a stress rating only; functional operation of the product at these or any other conditions above those indicated in the operational section of this specification is not implied. Operation beyond the maximum operating conditions for extended periods may affect product reliability.

THERMAL RESISTANCE

Thermal performance is directly linked to printed circuit board (PCB) design and operating environment. Careful attention to PCB thermal design is required.

Table 7. Thermal Resistance

Package Type	θ_{JA} ¹	θ_{JC} ²	Unit
5-Lead SC70 (KS-5)	376	189	°C/W
5-Lead TSOT (UJ-5)	230	146	°C/W
8-Lead SOIC (R-8)	130	43	°C/W

¹ θ_{JA} is specified for the worst-case conditions, that is, a device soldered in a circuit board for surface-mount packages.

² θ_{JC} is the junction-to-case thermal resistance.

ESD CAUTION



ESD (electrostatic discharge) sensitive device. Charged devices and circuit boards can discharge without detection. Although this product features patented or proprietary protection circuitry, damage may occur on devices subjected to high energy ESD. Therefore, proper ESD precautions should be taken to avoid performance degradation or loss of functionality.

TYPICAL PERFORMANCE CHARACTERISTICS

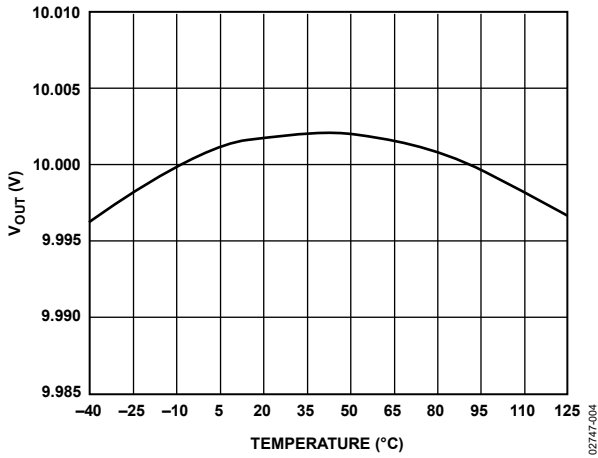

Figure 3. ADR01 Typical V_{OUT} vs. Temperature

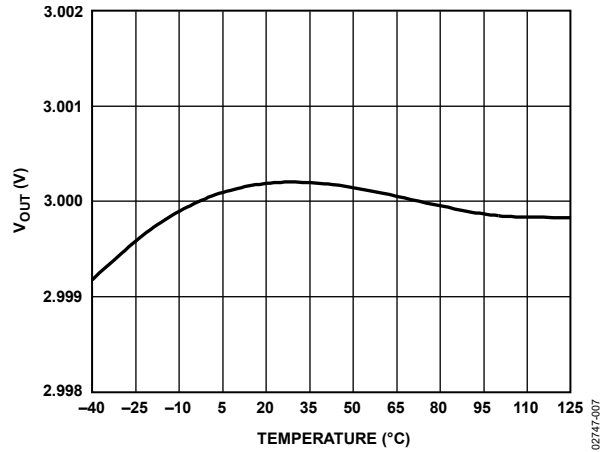

Figure 6. ADR06 Typical V_{OUT} vs. Temperature

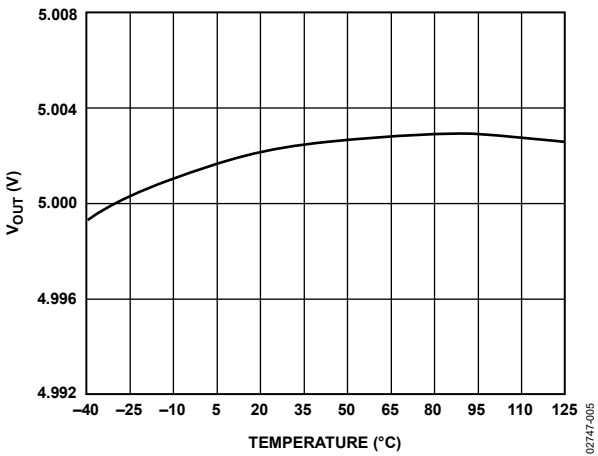

Figure 4. ADR02 Typical V_{OUT} vs. Temperature

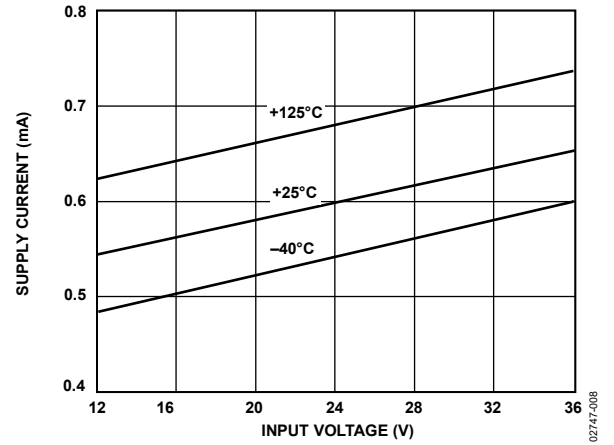

Figure 7. ADR01 Supply Current vs. Input Voltage

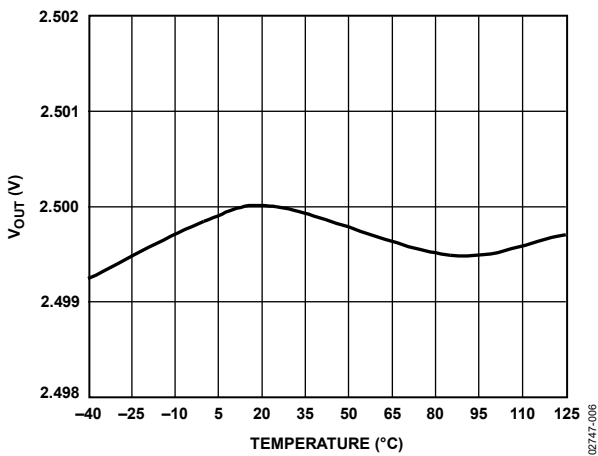

Figure 5. ADR03 Typical V_{OUT} vs. Temperature

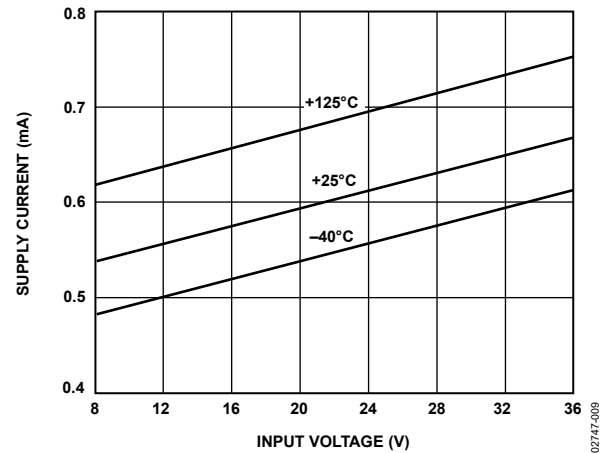

Figure 8. ADR02 Supply Current vs. Input Voltage

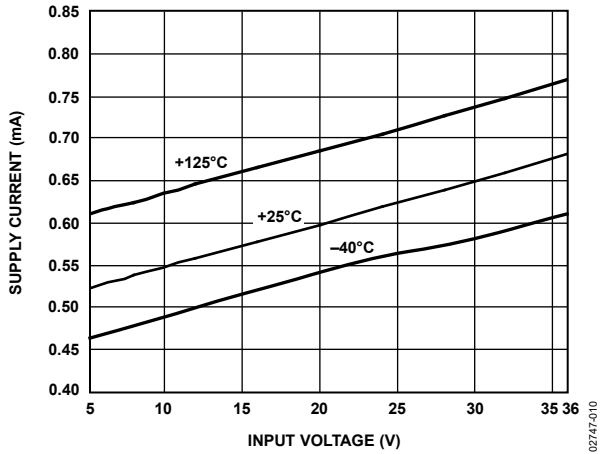

Figure 9. ADR03 Supply Current vs. Input Voltage

02747-010

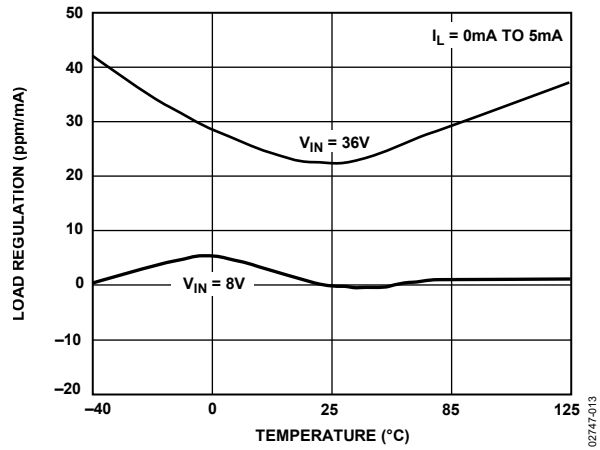

Figure 12. ADR02 Load Regulation vs. Temperature

02747-013

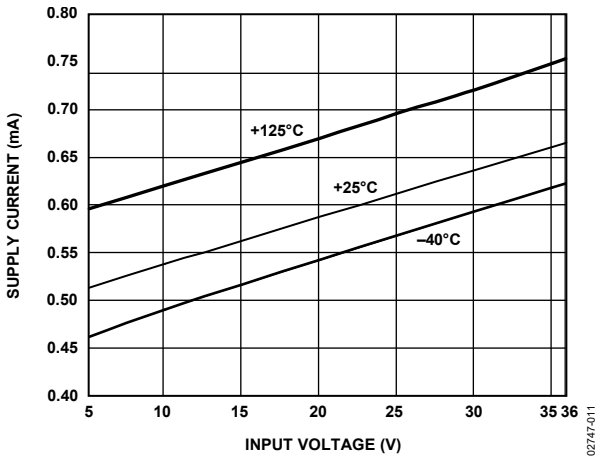

Figure 10. ADR06 Supply Current vs. Input Voltage

02747-011

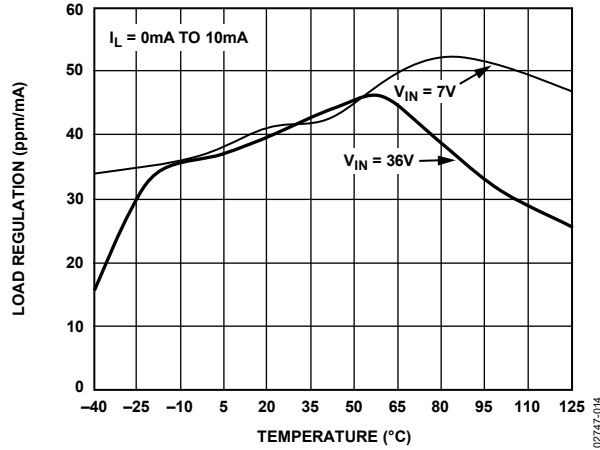

Figure 13. ADR03 Load Regulation vs. Temperature

02747-014

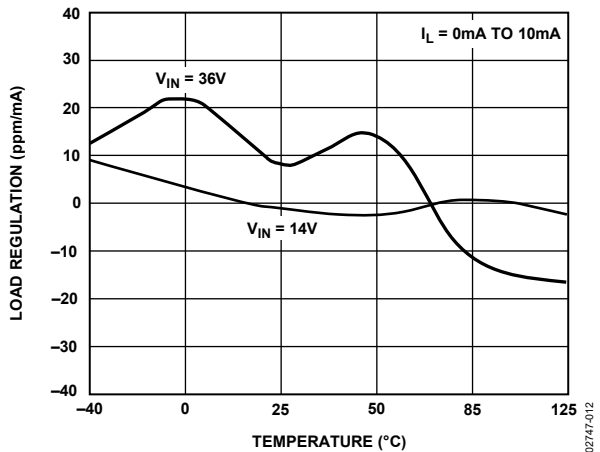

Figure 11. ADR01 Load Regulation vs. Temperature

02747-012

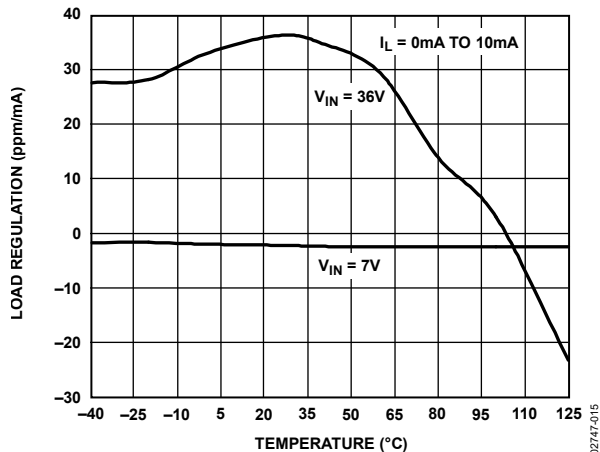

Figure 14. ADR06 Load Regulation vs. Temperature

02747-015

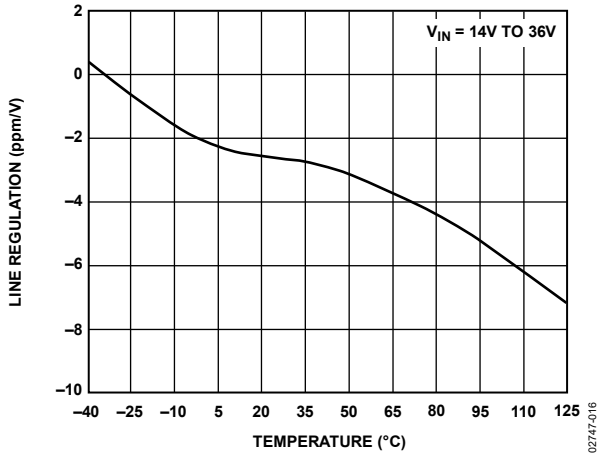

Figure 15. ADR01 Line Regulation vs. Temperature

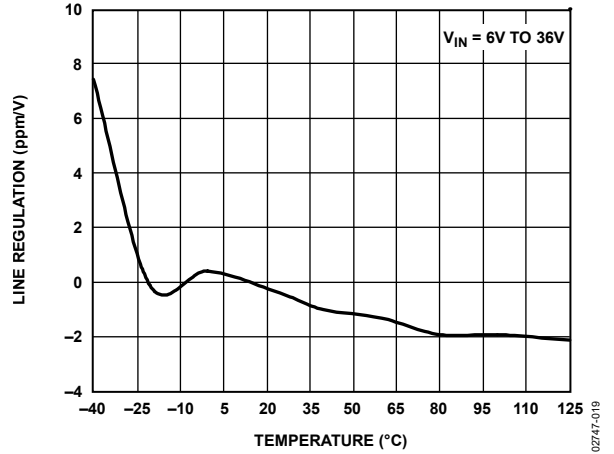

Figure 18. ADR06 Line Regulation vs. Temperature

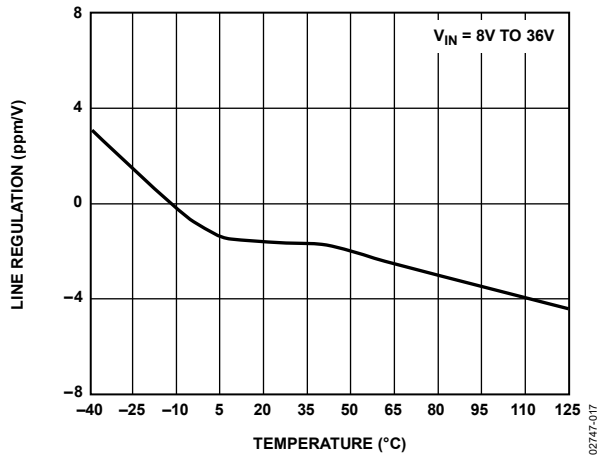

Figure 16. ADR02 Line Regulation vs. Temperature

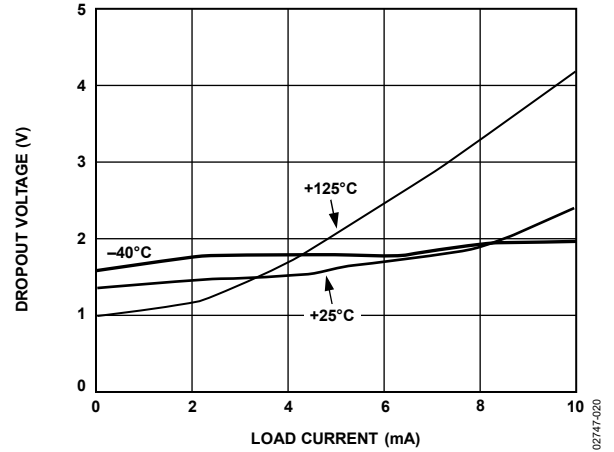

Figure 19. ADR01 Dropout Voltage vs. Load Current

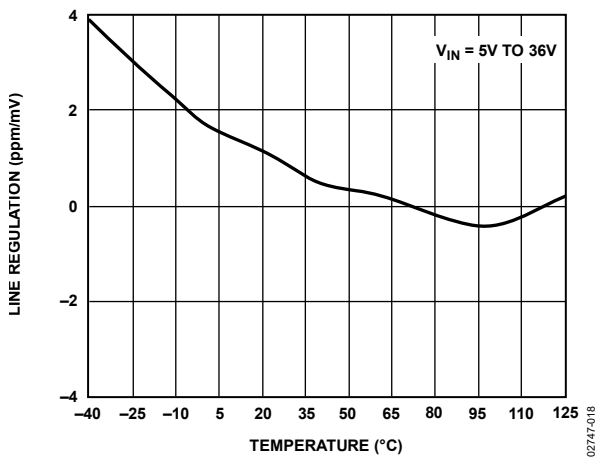

Figure 17. ADR03 Line Regulation vs. Temperature

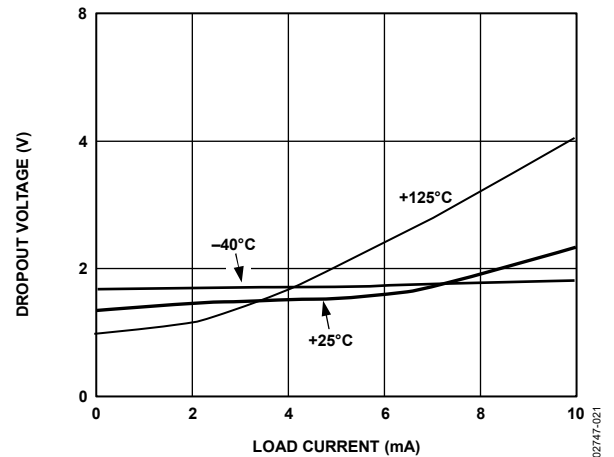

Figure 20. ADR02 Dropout Voltage vs. Load Current

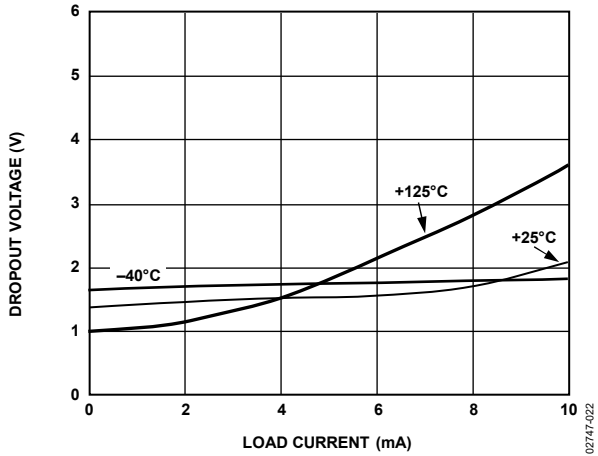

Figure 21. ADR03 Dropout Voltage vs. Load Current

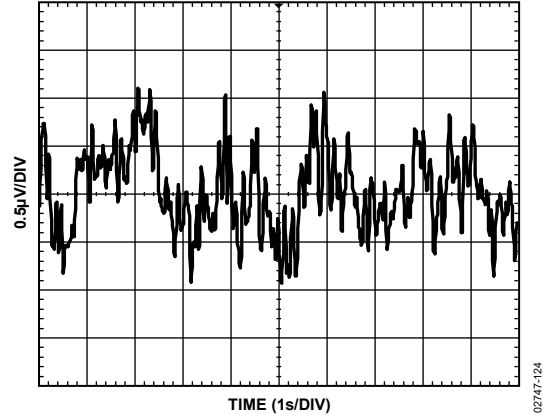

Figure 24. ADR01 Typical Noise Voltage, 0.1 Hz to 10.0 Hz

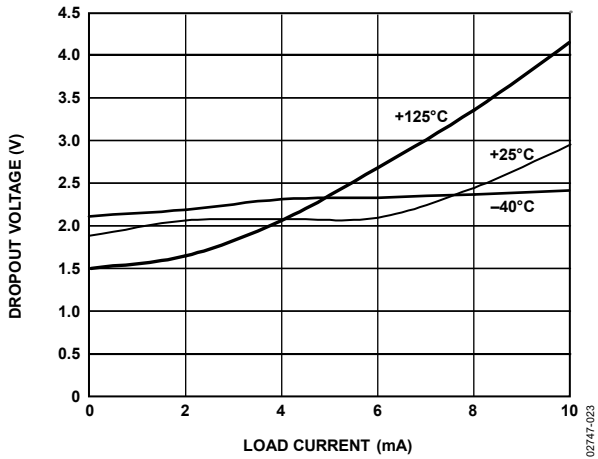

Figure 22. ADR06 Dropout Voltage vs. Load Current

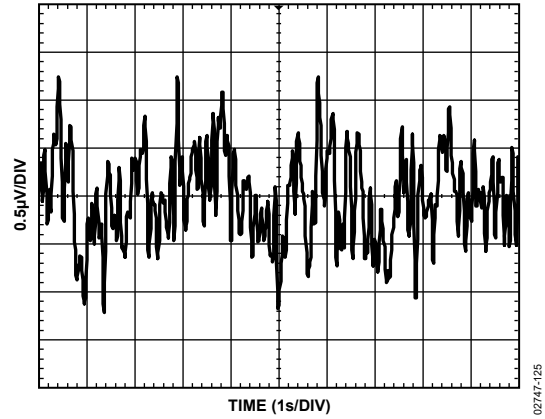

Figure 25. ADR02 Typical Noise Voltage, 0.1 Hz to 10.0 Hz

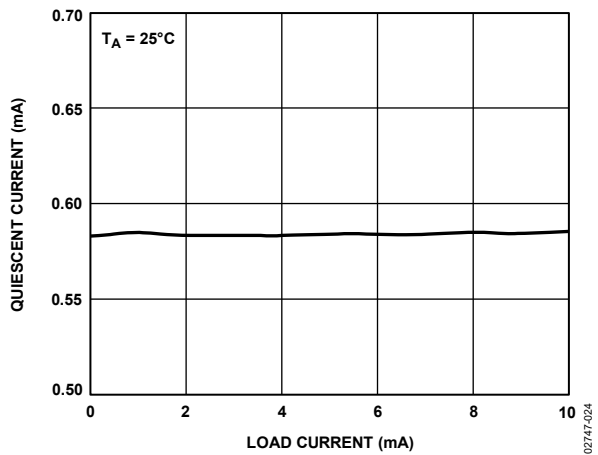

Figure 23. ADR01 Quiescent Current vs. Load Current

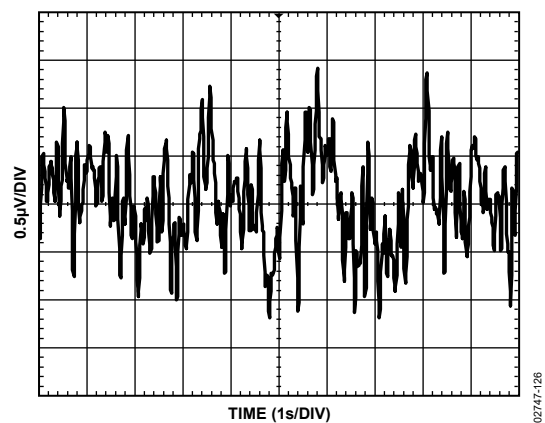

Figure 26. ADR03 Typical Noise Voltage, 0.1 Hz to 10.0 Hz

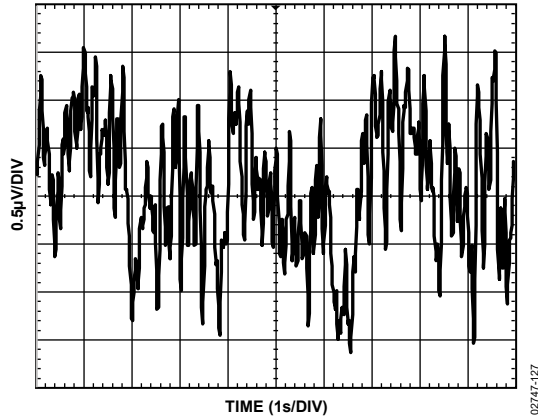

Figure 27. ADR06 Typical Noise Voltage, 0.1 Hz to 10.0 Hz

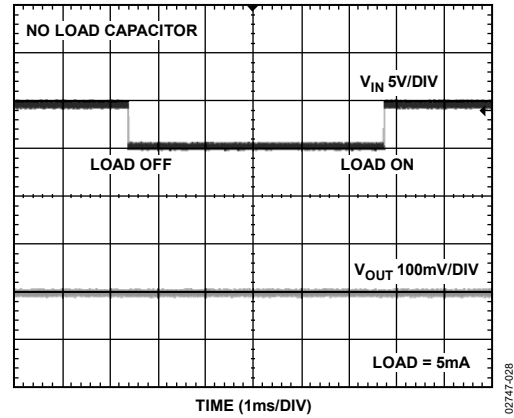

Figure 30. ADR02 Load Transient Response

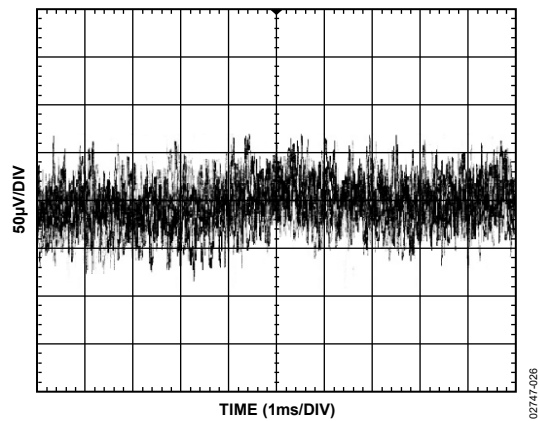

Figure 28. ADR02 Typical Noise Voltage, 10 Hz to 10 kHz

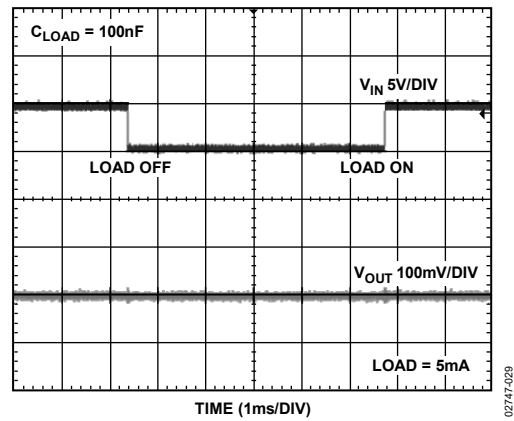

Figure 31. ADR02 Load Transient Response (C_{LOAD} Means Load Capacitance)

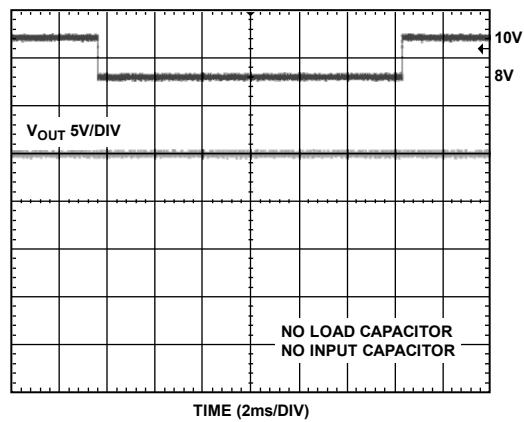

Figure 29. ADR02 Line Transient Response

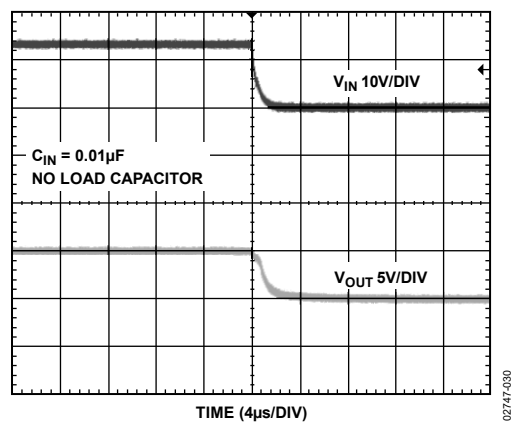

Figure 32. ADR02 Turn-Off Response (C_{IN} Means Input Capacitance)

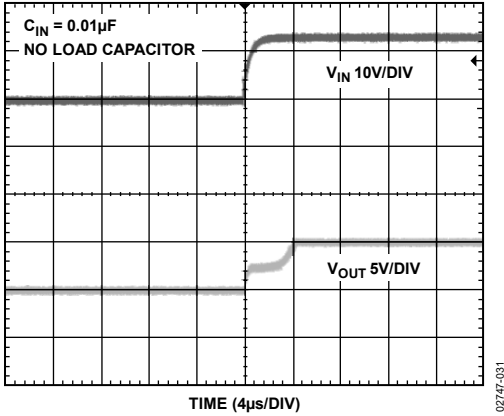

Figure 33. ADR02 Turn-On Response

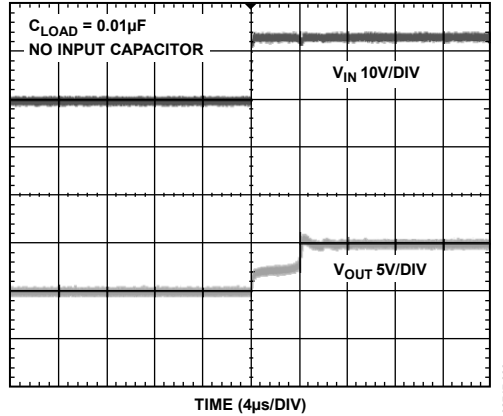

Figure 35. ADR02 Turn-Off with No Input Capacitor

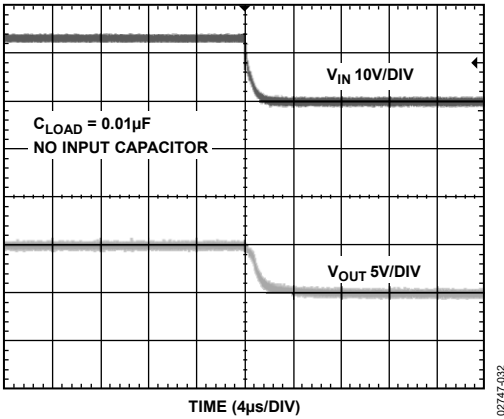

Figure 34. ADR02 Turn-Off with No Input Capacitor

TERMINOLOGY

Dropout Voltage (V_{DO})

Dropout voltage, sometimes referred to as supply voltage headroom or supply output voltage differential, is defined as the minimum voltage differential between the input and output necessary for the device to operate, such as

$$V_{DO} = (V_{IN} - V_{OUT})_{\min}|_{I_L} = \text{Constant}$$

Because the dropout voltage depends upon the current passing through the device, it is always specified for a given load current.

Temperature Coefficient (TCV_O)

The temperature coefficient relates the change in output voltage to the change in ambient temperature of the device, as normalized by the output voltage at 25°C. TCV_O is expressed in ppm/°C and is determined by the following equation:

$$TCV_O = \frac{V_{OUT}(T_2) - V_{OUT}(T_1)}{V_{OUT}(25^\circ\text{C}) \times (T_2 - T_1)} \times 10^6 \text{ (ppm/}^\circ\text{C)}$$

where:

$V_{OUT}(T_2)$ is the output voltage at Temperature 2.

$V_{OUT}(T_1)$ is the output voltage at Temperature 1.

$V_{OUT}(25^\circ\text{C})$ is the output voltage at 25°C.

Output Voltage Hysteresis (ΔV_{OUT_HYS})

Output voltage hysteresis represents the change in output voltage after the device is exposed to a specified temperature cycle. ΔV_{OUT_HYS} can be expressed as either a shift in voltage or a difference in parts per million from the nominal output as follows:

$$V_{OUT_HYS} = V_{OUT}(25^\circ\text{C}) - V_{OUT_TC} \text{ (V)}$$

$$V_{OUT_HYS} = \frac{V_{OUT}(25^\circ\text{C}) - V_{OUT_TC}}{V_{OUT}(25^\circ\text{C})} \times 10^6 \text{ (ppm)}$$

where V_{OUT_TC} is the output voltage after temperature cycling.

Thermal hysteresis occurs as a result of forces exhibited upon the internal die by its packaging. The effect is more pronounced in devices with smaller packages.

Long-Term Stability (ΔV_{OUT_LTD})

Long-term stability refers to the shift in output voltage at 25°C after 1000 hours of operation in a 25°C environment. ΔV_{OUT_LTD} can also be expressed as either a shift in voltage or a difference in parts per million from the nominal output as follows:

$$\Delta V_{OUT_LTD} = |V_{OUT}(t_1) - V_{OUT}(t_0)| \text{ (V)}$$

$$\Delta V_{OUT_LTD} = \left| \frac{V_{OUT}(t_1) - V_{OUT}(t_0)}{V_{OUT}(t_0)} \right| \times 10^6 \text{ (ppm)}$$

where:

$V_{OUT}(t_1)$ is the V_{OUT} at 25°C after 1000 hours of operation at 25°C.

$V_{OUT}(t_0)$ is the V_{OUT} at 25°C at Time 0.

Line Regulation

Line regulation refers to the change in output voltage in response to a given change in input voltage and is expressed in either percent per volt, parts per million per volt, or microvolt per volt change in input voltage. This parameter accounts for the effects of self heating.

Load Regulation

Load regulation refers to the change in output voltage in response to a given change in load current and is expressed in either microvolts per milliampere, parts per million per milliampere, or ohms of dc output resistance. This parameter accounts for the effects of self heating.

APPLICATIONS INFORMATION

OVERVIEW

The ADR01/ADR02/ADR03/ADR06 are high precision, low drift 10.0 V, 5.0 V, 2.5 V, and 3.0 V, respectively, voltage references available in an ultracompact footprint. The 8-lead SOIC version of the devices is a drop-in replacement of the REF01/REF02/REF03 sockets with improved cost and performance.

These devices are standard band gap references (see Figure 37). The band gap cell contains two NPN transistors (Q18 and Q19) that differ in emitter area by 2×. The difference in their voltage between base and emitter (V_{BE}) produces a proportional-to-absolute temperature current (PTAT) in R14, and, when combined with the V_{BE} of Q19, produces a band gap voltage, V_{BG} , that is almost constant in temperature. With an internal op amp and the feedback network of R5 and R6, V_{OUT} is set precisely at 10.0 V, 5.0 V, 2.5 V, and 3.0 V for the ADR01, ADR02, ADR03, and ADR06, respectively. Precision laser trimming of the resistors and other proprietary circuit techniques are used to further enhance the initial accuracy, temperature curvature, and drift performance of the ADR01/ADR02/ADR03/ADR06.

The PTAT voltage is made available at the TEMP pin of the ADR01/ADR02/ADR03/ADR06. The TEMP pin has a stable 1.96 mV/°C temperature sensitivity such that users can estimate the temperature change of the devices by knowing the voltage change at the TEMP pin.

APPLYING THE ADR01/ADR02/ADR03/ADR06

Input and Output Capacitors

Although the ADR01/ADR02/ADR03/ADR06 are designed to function stably without any external components, connecting a 0.1 μF ceramic capacitor to the output is highly recommended to improve stability and filter out low level voltage noise. An additional 1 μF to 10 μF electrolytic, tantalum, or ceramic capacitor can be added in parallel to improve transient performance in response to sudden changes in load current. However, know that doing so increases the turn-on time of the devices.

To improve transient response in applications where the supply voltage can fluctuate, connect a 1 μF to 10 μF electrolytic, tantalum or ceramic capacitor to the input.

Connect an additional 0.1 μF ceramic capacitor in parallel to reduce supply noise. Mount both input and output capacitors as close to the pins of the devices as possible.

Output Adjustment

The ADR01/ADR02/ADR03/ADR06 trim terminal can adjust the output voltage over a nominal voltage. This feature allows a system designer to trim system errors by setting the reference to a voltage other than 10.0 V, 5.0 V, 2.5 V, or 3.0 V. For finer adjustment, add a series resistor of 470 k Ω . With the configuration shown in Figure 38, the ADR01 can adjust from 9.70 V to 10.05 V, the ADR02 can adjust from 4.95 V to 5.02 V, the ADR03 can adjust from 2.3 V to 2.8 V, and the ADR06 can adjust from 2.8 V to 3.3 V. Adjustment of the output does not significantly affect the temperature performance of the devices provided the temperature coefficients of the resistors are relatively low.

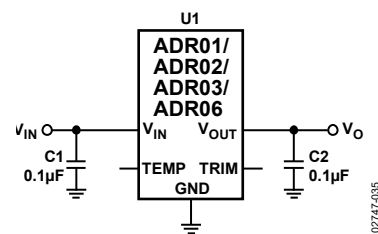

Figure 36. Basic Configuration

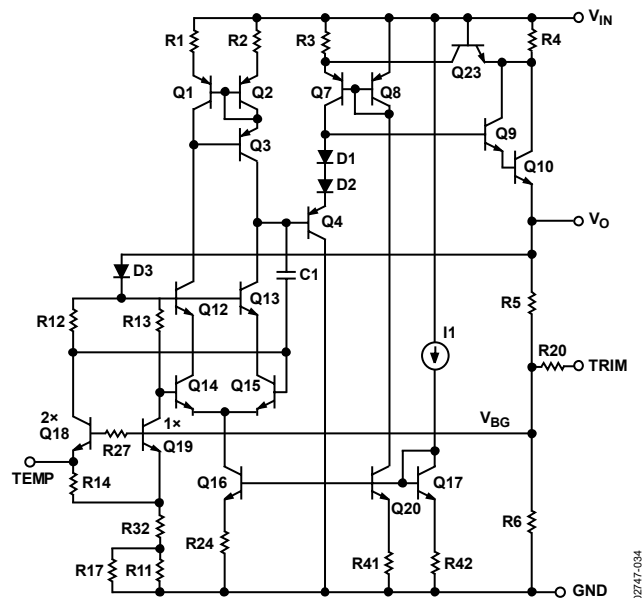

Figure 37. Simplified Schematic Diagram

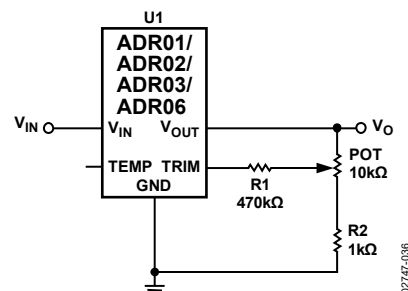

Figure 38. Optional Trim Adjustment

Temperature Monitoring

As described at the end of the Overview section, the ADR01/ADR02/ADR03/ADR06 provide a TEMP output (Pin 1 in Figure 1 and Pin 3 in Figure 2) that varies linearly with temperature. This output can monitor the temperature change in the system. The TEMP voltage (V_{TEMP}) is approximately 550 mV at 25°C, and the temperature sensitivity is approximately 1.96 mV/°C (see Figure 39). A voltage change of 39.2 mV at the TEMP pin corresponds to a 20°C change in temperature.

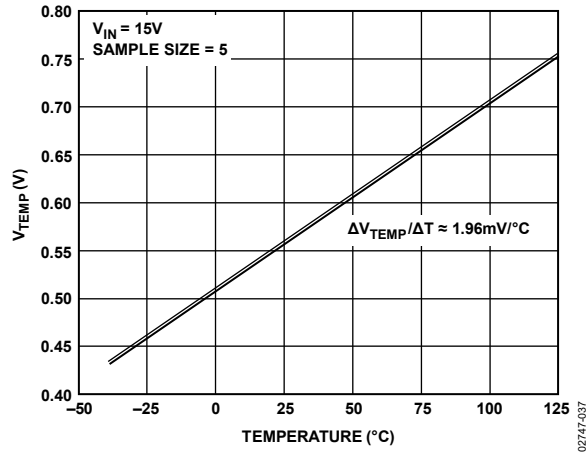

Figure 39. V_{TEMP} vs. Temperature

The TEMP function is provided as a convenience rather than a precise feature. Because the voltage at the TEMP node is acquired from the band gap core, current pulling from this pin has a significant effect on V_{OUT} . Care must be taken to buffer the TEMP output with a suitable low bias current op amp, such as the LTC2058, ADA4077-1, or ADA4522-1, all of which result in less than a 100 μ V change in ΔV_{OUT} (see Figure 40). Without buffering, even tens of microamps drawn from the TEMP pin can cause V_{OUT} to fall out of specification.

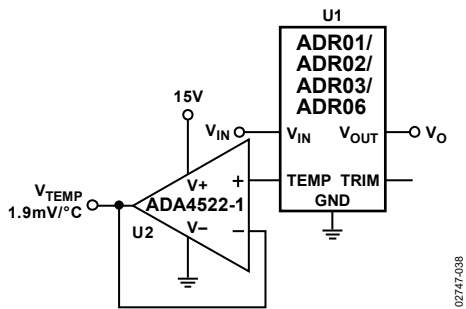

Figure 40. Temperature Monitoring

LOW COST CURRENT SOURCE

Unlike most references, the ADR01/ADR02/ADR03/ADR06 employ an NPN Darlington in which the quiescent current remains constant with respect to the load current, as shown in Figure 23. As a result, a current source can be configured as shown in Figure 41 where $I_{SET} = (V_{OUT} - V_L)/R_{SET}$. I_L is simply the sum of I_{SET} and I_Q . Although simple, I_Q varies typically from 0.55 mA to 0.65 mA, limiting this circuit to general-purpose applications.

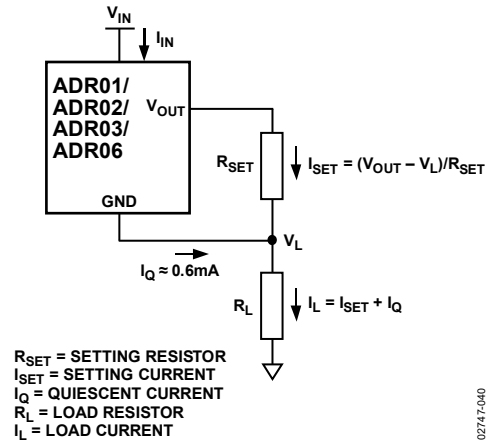

Figure 41. Low Cost Current Source

PRECISION CURRENT SOURCE WITH ADJUSTABLE OUTPUT

Alternatively, a precision current source can be implemented with the circuit shown in Figure 42 using ADR02 as an example. By adding a mechanical or digital potentiometer, this circuit becomes an adjustable current source. If a digital potentiometer is used, the load current is simply the voltage across Terminal B to Terminal W of the digital potentiometer divided by R_{SET} .

$$I_L = (V_{REF} \times D)/R_{SET} \tag{1}$$

where D is the decimal equivalent of the digital potentiometer input code.

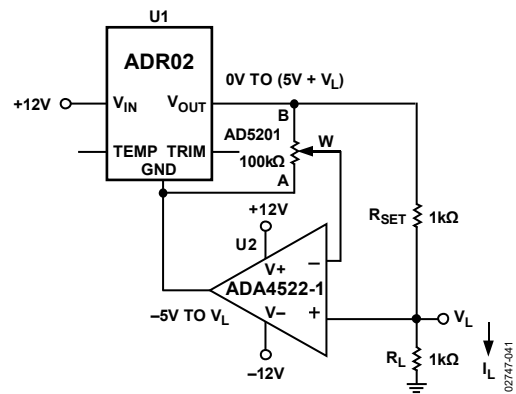

Figure 42. Programmable 0 mA to 5 mA Current Source

To optimize the resolution of this circuit, use dual-supply op amps because the ground potential of ADR02 can swing from -5.0 V at zero scale to V_L at full scale of the potentiometer setting.

OUTLINE DIMENSIONS

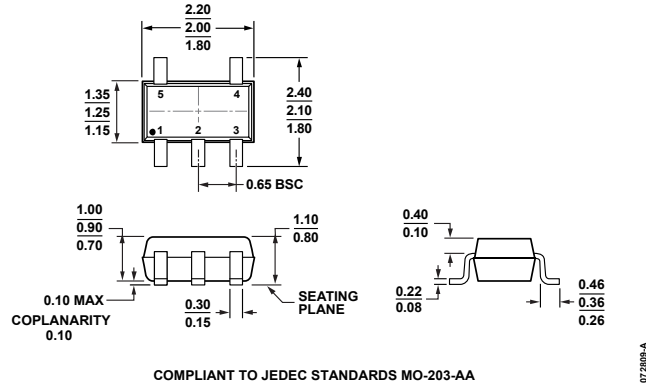

Figure 46. 5-Lead Thin Shrink Small Outline Transistor Package [SC70] (KS-5)
Dimensions shown in millimeters

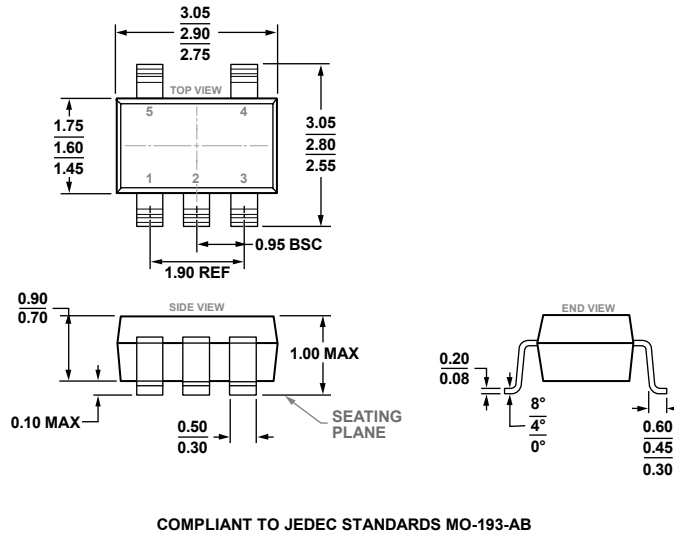

Figure 47. 5-Lead Thin Small Outline Transistor Package [TSOT] (UJ-5)
Dimensions shown in millimeters

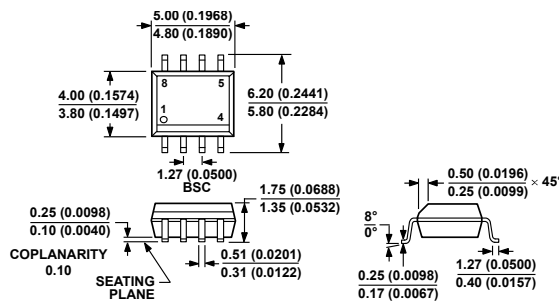

Figure 48. 8-Lead Standard Small Outline Package [SOIC_N] Narrow Body (R-8)
Dimensions shown in millimeters and (inches)

ADR01/ADR02/ADR03/ADR06

Data Sheet

ORDERING GUIDES

ADR01 Ordering Guide

Model ^{1,2}	V _{OUT} (V)	Initial Accuracy		Temperature Coefficient (ppm/°C)	Temperature Range	Package Description	Package Option	Ordering Quantity	Marking Code
		(mV)	(%)						
ADR01ARZ	10	10	0.1	10	-40°C to +125°C	8-Lead SOIC_N	R-8	98	
ADR01ARZ-REEL7	10	10	0.1	10	-40°C to +125°C	8-Lead SOIC_N	R-8	1,000	
ADR01BRZ	10	5	0.05	3	-40°C to +125°C	8-Lead SOIC_N	R-8	98	
ADR01BRZ-REEL7	10	5	0.05	3	-40°C to +125°C	8-Lead SOIC_N	R-8	1000	
ADR01WARZ-R7	10	14	0.14	10	-40°C to +125°C	8-Lead SOIC_N	R-8	1,000	
ADR01WARZ-RL	10	14	0.14	10	-40°C to +125°C	8-Lead SOIC_N	R-8	2,500	
ADR01AUJZ-REEL7	10	10	0.1	25	-40°C to +125°C	5-Lead TSOT	UJ-5	3,000	R1E
ADR01BUJZ-REEL7	10	5	0.05	9	-40°C to +125°C	5-Lead TSOT	UJ-5	3,000	R1F
ADR01AKSZ-REEL7	10	10	0.1	25	-40°C to +125°C	5-Lead SC70	KS-5	3,000	R1E
ADR01BKSZ-REEL7	10	5	0.05	9	-40°C to +125°C	5-Lead SC70	KS-5	3,000	R1F

¹ Z = RoHS Compliant Part.² W = Qualified for automotive applications.

ADR02 Ordering Guide

Model ^{1,2}	V _{OUT} (V)	Initial Accuracy		Temperature Coefficient (ppm/°C)	Temperature Range	Package Description	Package Option	Ordering Quantity	Marking Code
		(mV)	(%)						
ADR02ARZ	5	5	0.1	10	-40°C to +125°C	8-Lead SOIC_N	R-8	98	
ADR02ARZ-REEL	5	5	0.1	10	-40°C to +125°C	8-Lead SOIC_N	R-8	2,500	
ADR02ARZ-REEL7	5	5	0.1	10	-40°C to +125°C	8-Lead SOIC_N	R-8	1,000	
ADR02WARZ-REEL	5	5	0.1	10	-40°C to +125°C	8-Lead SOIC_N	R-8	2,500	
ADR02WARZ-REEL7	5	5	0.1	10	-40°C to +125°C	8-Lead SOIC_N	R-8	1,000	
ADR02BRZ	5	3	0.06	3	-40°C to +125°C	8-Lead SOIC_N	R-8	98	
ADR02BRZ-REEL7	5	3	0.06	3	-40°C to +125°C	8-Lead SOIC_N	R-8	1,000	
ADR02AUJZ-REEL7	5	5	0.1	25	-40°C to +125°C	5-Lead TSOT	UJ-5	3,000	R1G
ADR02BUJZ-REEL7	5	3	0.06	9	-40°C to +125°C	5-Lead TSOT	UJ-5	3,000	R1H
ADR02AKSZ-REEL7	5	5	0.1	25	-40°C to +125°C	5-Lead SC70	KS-5	3,000	R1G
ADR02BKSZ-REEL7	5	3	0.06	9	-40°C to +125°C	5-Lead SC70	KS-5	3,000	R1H

¹ Z = RoHS Compliant Part.² W = Qualified for automotive applications.

Data Sheet

ADR01/ADR02/ADR03/ADR06

ADR03 Ordering Guide

Model ^{1,2}	V _{OUT} (V)	Initial Accuracy		Temperature Coefficient (ppm/°C)	Temperature Range	Package Description	Package Option	Ordering Quantity	Marking Code
		(mV)	(%)						
ADR03ARZ	2.5	5	0.2	10	-40°C to +125°C	8-Lead SOIC_N	R-8	98	
ADR03ARZ-REEL7	2.5	5	0.2	10	-40°C to +125°C	8-Lead SOIC_N	R-8	1,000	
ADR03WARZ-R7	2.5	5	0.2	10	-40°C to +125°C	8-Lead SOIC_N	R-8	1,000	
ADR03WARZ-RL	2.5	5	0.2	10	-40°C to +125°C	8-Lead SOIC_N	R-8	2500	
ADR03BRZ	2.5	2.5	0.1	3	-40°C to +125°C	8-Lead SOIC_N	R-8	98	
ADR03BRZ-REEL7	2.5	2.5	0.1	3	-40°C to +125°C	8-Lead SOIC_N	R-8	1,000	
ADR03AUJZ-REEL7	2.5	5	0.2	25	-40°C to +125°C	5-Lead TSOT	UJ-5	3,000	R1J
ADR03BUJZ-REEL7	2.5	2.5	0.1	9	-40°C to +125°C	5-Lead TSOT	UJ-5	3,000	R1K
ADR03AKSZ-REEL7	2.5	5	0.2	25	-40°C to +125°C	5-Lead SC70	KS-5	3,000	R1J
ADR03BKSZ-REEL7	2.5	2.5	0.1	9	-40°C to +125°C	5-Lead SC70	KS-5	3,000	R1K

¹ Z = RoHS Compliant Part.² W = Qualified for automotive applications.

ADR06 Ordering Guide

Model ^{1,2}	V _{OUT} (V)	Initial Accuracy		Temperature Coefficient (ppm/°C)	Temperature Range	Package Description	Package Option	Ordering Quantity	Marking Code
		(mV)	(%)						
ADR06ARZ	3	6	0.2	10	-40°C to +125°C	8-Lead SOIC_N	R-8	98	
ADR06ARZ-REEL7	3	6	0.2	10	-40°C to +125°C	8-Lead SOIC_N	R-8	1,000	
ADR06WARZ-R7	3	6	0.2	10	-40°C to +125°C	8-Lead SOIC_N	R-8	1,000	
ADR06WARZ-RL	3	6	0.2	10	-40°C to +125°C	8-Lead SOIC_N	R-8	2500	
ADR06BRZ	3	3	0.1	3	-40°C to +125°C	8-Lead SOIC_N	R-8	98	
ADR06BRZ-REEL7	3	3	0.1	3	-40°C to +125°C	8-Lead SOIC_N	R-8	1,000	
ADR06BUJZ-REEL7	3	3	0.1	9	-40°C to +125°C	5-Lead TSOT	UJ-5	3,000	R1M
ADR06AKSZ-REEL7	3	6	0.2	25	-40°C to +125°C	5-Lead SC70	KS-5	3,000	R1L
ADR06BKSZ-REEL7	3	3	0.1	9	-40°C to +125°C	5-Lead SC70	KS-5	3,000	R1M

¹ Z = RoHS Compliant Part.² W = Qualified for automotive applications.

AUTOMOTIVE PRODUCTS

The ADR01W, ADR02W, ADR03W and ADR06W models are available with controlled manufacturing to support the quality and reliability requirements of automotive applications. Note that these automotive models may have specifications that differ from the commercial models; therefore, designers should review the Specifications section of this data sheet carefully. Only the automotive grade products shown are available for use in automotive applications. Contact your local Analog Devices account representative for specific product ordering information and to obtain the specific Automotive Reliability reports for these models.

OUR CERTIFICATE

DiGi provide top-quality products and perfect service for customer worldwide through standardization, technological innovation and continuous improvement. DiGi through third-party certification, we stricly control the quality of products and services. Welcome your RFQ to

Email: Info@DiGi-Electronics.com



Tel: +00 852-30501935

RFQ Email: Info@DiGi-Electronics.com

DiGi is a global authorized distributor of electronic components.