

ADR512ARTZ-REEL7 Datasheet

www.digi-electronics.com

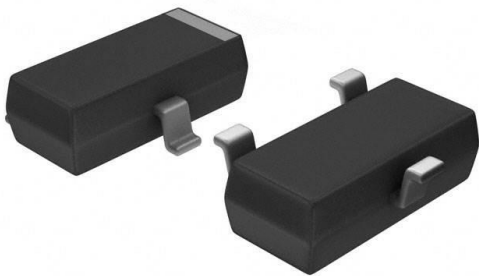

<https://www.DiGi-Electronics.com>

DiGi Electronics Part Number	ADR512ARTZ-REEL7-DG
Manufacturer	Analog Devices Inc.
Manufacturer Product Number	ADR512ARTZ-REEL7
Description	IC VREF SHUNT 0.3% SOT23-3
Detailed Description	Shunt Voltage Reference IC Fixed 1.2V V \pm 0.3% 10 mA SOT-23-3

This model ADR512ARTZ-REEL7 is available at DiGi Electronics.

DiGi Electronics offers a global database of semiconductor and electronic component datasheets.

We welcome your inquiries regarding pricing, lead time, or other product-related questions.

 [Request a Quote](#)

 [Datasheet Search](#)



Tel: +00 852-30501935

RFQ Email: Info@DiGi-Electronics.com

DiGi is a global authorized distributor of electronic components.

Purchase and inquiry

Manufacturer Product Number:

ADR512ARTZ-REEL7

Series:

-

Reference Type:

Shunt

Voltage - Output (Min/Fixed):

1.2V

Tolerance:

±0.3%

Noise - 0.1Hz to 10Hz:

4µVp-p

Voltage - Input:

-

Current - Cathode:

100 µA

Mounting Type:

Surface Mount

Supplier Device Package:

SOT-23-3

Manufacturer:

Analog Devices Inc.

Product Status:

Active

Output Type:

Fixed

Current - Output:

10 mA

Temperature Coefficient:

60ppm/°C

Noise - 10Hz to 10kHz:

-

Current - Supply:

-

Operating Temperature:

-40°C ~ 85°C (TA)

Package / Case:

TO-236-3, SC-59, SOT-23-3

Base Product Number:

ADR512

Environmental & Export classification

RoHS Status:

ROHS3 Compliant

REACH Status:

REACH Unaffected

HTSUS:

8542.39.0001

Moisture Sensitivity Level (MSL):

1 (Unlimited)

ECCN:

EAR99



1.2 V Precision Low Noise Shunt Voltage Reference

Data Sheet

ADR512

FEATURES

Precision 1.200 V Voltage Reference
Ultracompact 3 mm × 3 mm SOT-23 Package
No External Capacitor Required
Low Output Noise: 4 μV p-p (0.1 Hz to 10 Hz)
Initial Accuracy: ±0.3% Max
Temperature Coefficient: 60 ppm/°C Max
Operating Current Range: 100 μA to 10 mA
Output Impedance: 0.3 Ω Max
Temperature Range: -40°C to +85°C

APPLICATIONS

Precision Data Acquisition Systems
Battery-Powered Equipment:
 Cellular Phone, Notebook Computer, PDA,
 and GPS

3 V/5 V, 8-/12-Bit Data Converters

Portable Medical Instruments

Industrial Process Control Systems

Precision Instruments

GENERAL DESCRIPTION

Designed for space critical applications, the ADR512 is a low voltage (1.200 V), precision shunt-mode voltage reference in the ultracompact (3 mm × 3 mm) SOT-23 package. The ADR512 features low temperature drift (60 ppm/°C), high accuracy (±0.30%), and ultralow noise (4 μV p-p) performance.

The ADR512's advanced design eliminates the need for an external capacitor, yet it is stable with any capacitive load. The minimum operating current increases from a scant 100 μA to a

PIN CONFIGURATION

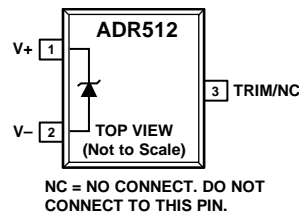

Figure 1. 3-Lead SOT-23

Table 1.

Model	Output Voltage (V _o)	Initial Accuracy		Temperature Coefficient (ppm/°C)
		(mV)	(%)	
ADR512ARTZ-REEL7	1.200	3.5	0.3	60

maximum of 10 mA. This low operating current and ease of use make the ADR512 ideally suited for handheld battery-powered applications.

A TRIM terminal is available on the ADR512 to provide adjustment of the output voltage over ±0.5% without affecting the temperature coefficient of the device. This feature provides users with the flexibility to trim out any system errors.

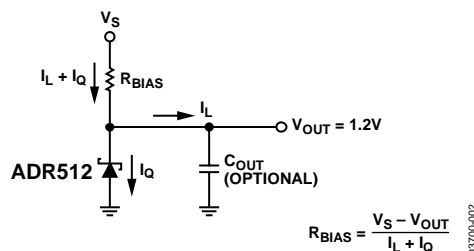

Figure 2. Typical Operating Circuit

Rev. A

[Document Feedback](#)

Information furnished by Analog Devices is believed to be accurate and reliable. However, no responsibility is assumed by Analog Devices for its use, nor for any infringements of patents or other rights of third parties that may result from its use. Specifications subject to change without notice. No license is granted by implication or otherwise under any patent or patent rights of Analog Devices. Trademarks and registered trademarks are the property of their respective owners.

One Technology Way, P.O. Box 9106, Norwood, MA 02062-9106, U.S.A.
 Tel: 781.329.4700 ©2003–2012 Analog Devices, Inc. All rights reserved.
[Technical Support](#) www.analog.com

TABLE OF CONTENTS

Features	1	Parameter Definitions.....	7
Applications.....	1	Temperature Coefficient.....	7
Pin Configuration.....	1	Thermal Hysteresis	7
General Description	1	Applications Section.....	8
Revision History	2	Adjustable Precision Voltage Source	8
Specifications.....	3	Output Voltage Trim	8
Electrical Characteristics	3	Using the ADR512 with Precision Data Converters	8
Absolute Maximum Ratings.....	4	Precise Negative Voltage Reference	9
Thermal Resistance	4	Outline Dimensions	10
ESD Caution.....	4	Ordering Guide	10
Typical Performance Characteristics	5		

REVISION HISTORY

11/12—Rev. 0 to Rev. A

Changes to Table 1	1
Updated Outline Dimensions	10
Changes to Ordering Guide	10

SPECIFICATIONS

ELECTRICAL CHARACTERISTICS

$I_{IN} = 100 \mu\text{A}$ to 10 mA @ $T_A = 25^\circ\text{C}$, unless otherwise noted.

Table 2.

Parameter	Symbol	Test Conditions / Comments	Min	Typ	Max	Unit
Output Voltage ¹	V_O		1.1965	1.2	1.2035	V
Initial Accuracy	V_{OERR}		-3.5		+3.5	mV
	$T_{OERR\%}$		-0.3		+0.3	%
Temperature Coefficient A Grade	TCV_O	$-40^\circ\text{C} < T_A < +85^\circ\text{C}$			60	ppm/ $^\circ\text{C}$
Output Voltage Change vs. I_{IN}	ΔV_R	$I_{IN} = 0.1 \text{ mA}$ to 10 mA			3	mV
Dynamic Output Impedance	$(\Delta V_R / \Delta I_R)$	$I_{IN} = 1 \text{ mA} \pm 100 \mu\text{A}$			0.3	Ω
Minimum Operating Current	I_{IN}	$-40^\circ\text{C} < T_A < +85^\circ\text{C}$	100			μA
Voltage Noise	e_N p-p	$f = 0.1 \text{ Hz}$ to 10 Hz		4		μV p-p
Turn-On Settling Time ²	t_R	To within 0.1% of Output		10		μs
Output Voltage Hysteresis	V_{O_HYS}			50		ppm

¹ The forward diode voltage characteristic at -1 mA is typically 0.65 V .

² Measured without a load capacitor.

ABSOLUTE MAXIMUM RATINGS

Table 3.

Parameter	Rating
Reverse Current	25 mA
Forward Current	20 mA
Storage Temperature Range	
RT Package	−65°C to +150°C
Operating Temperature Range	−40°C to +85°C
Junction Temperature Range	
RT Package	−65°C to +150°C
Lead Temperature Range (Soldering, 60 Sec)	300°C

Stresses above those listed under Absolute Maximum Ratings may cause permanent damage to the device. This is a stress rating only; functional operation of the device at these or any other conditions above those indicated in the operational section of this specification is not implied. Exposure to absolute maximum rating conditions for extended periods may affect device reliability.

THERMAL RESISTANCE

θ_{JA} is specified for the worst-case conditions, that is, a device soldered in a circuit board for surface-mount packages.

Table 4. Thermal Resistance

Package Type ¹	θ_{JA} ²	θ_{JC}	Unit
3-SOT-23 (RT)	230	146	°C/W

¹Package power dissipation = $(T_{JMAX} - T_A)/\theta_{JA}$.

² θ_{JA} is specified for worst-case conditions, i.e., θ_{JA} is specified for device soldered.

ESD CAUTION



ESD (electrostatic discharge) sensitive device. Charged devices and circuit boards can discharge without detection. Although this product features patented or proprietary protection circuitry, damage may occur on devices subjected to high energy ESD. Therefore, proper ESD precautions should be taken to avoid performance degradation or loss of functionality.

TYPICAL PERFORMANCE CHARACTERISTICS

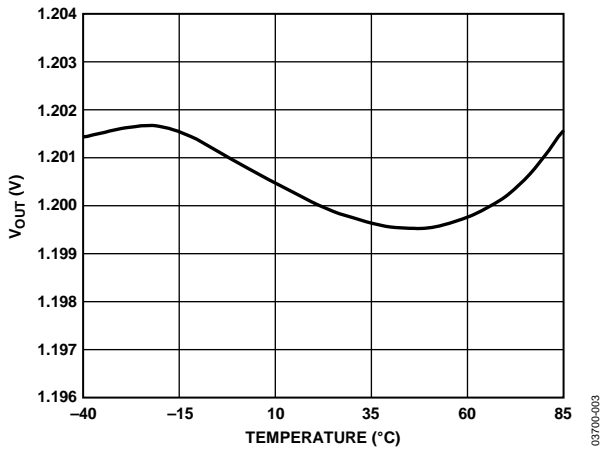

Figure 3. Typical V_{OUT} vs. Temperature

03700-003

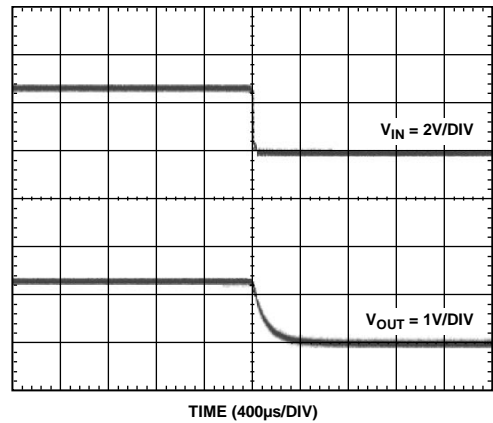

Figure 6. Turn Off Time

03700-006

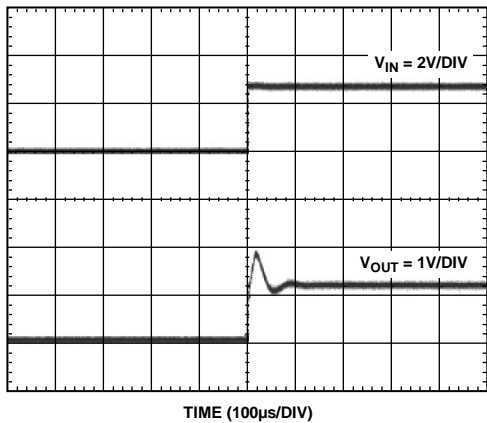

Figure 4. Turn On Time

03700-004

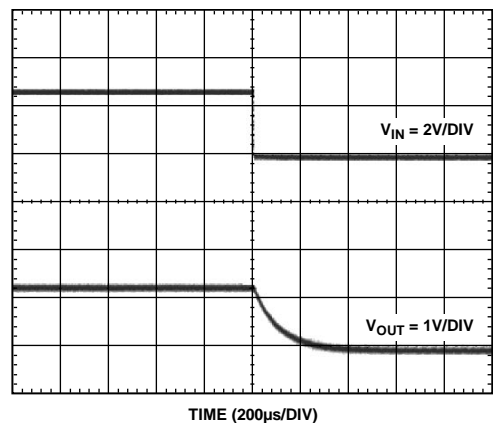

Figure 7. Turn Off Time with 1 μ F Input Capacitor

03700-007

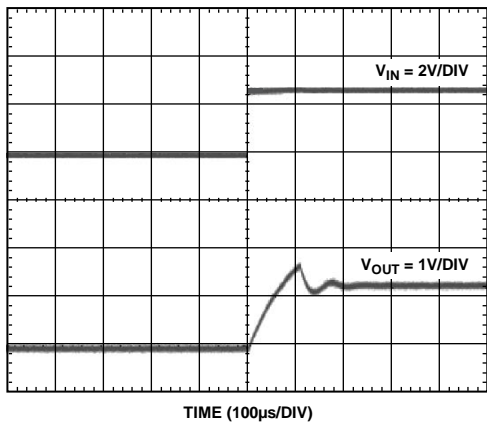

Figure 5. Turn On Time with 1 μ F Input Capacitor

03700-005

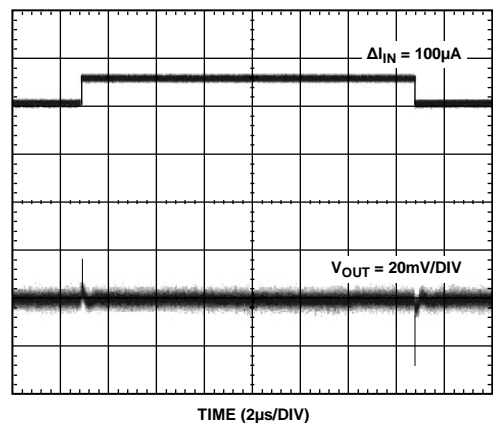

Figure 8. Output Response to 100 μ A Input Current Change

03700-008

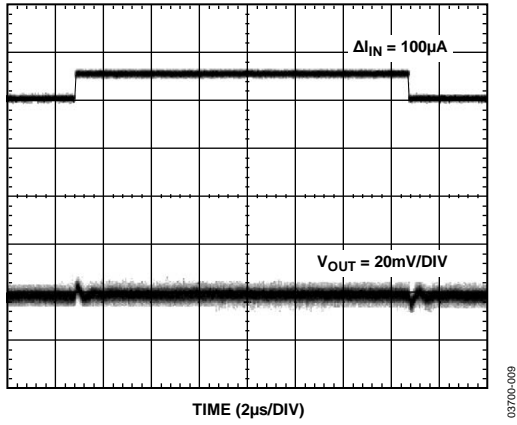

Figure 9. Output Response to 100 μA Input Current Change With 1 μF Capacitor

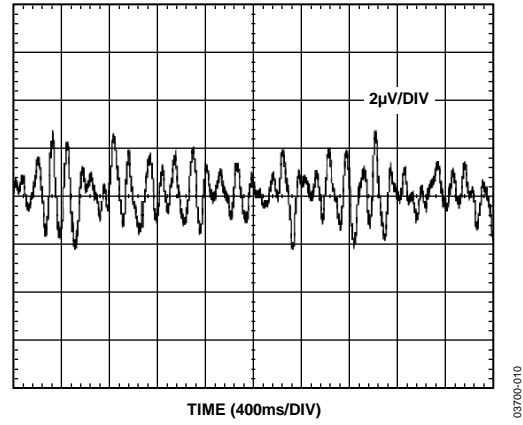

Figure 10. 1 Hz to 10 Hz Noise

PARAMETER DEFINITIONS

TEMPERATURE COEFFICIENT

This is the change of output voltage with respect to operating temperature changes, normalized by the output voltage at 25°C. This parameter is expressed in ppm/°C and can be determined with the following equation:

$$TCV_o \left[\frac{ppm}{^\circ C} \right] = \frac{V_o(T_2) - V_o(T_1)}{V_o(25^\circ C) \times (T_2 - T_1)} \times 10^6 \quad (1)$$

where:

$V_o(25^\circ C) = V_o$ at 25°C

$V_o(T_1) = V_o$ at Temperature 1

$V_o(T_2) = V_o$ at Temperature 2

THERMAL HYSTERESIS

Thermal hysteresis is defined as the change of output voltage after the device is cycled through the temperature from +25°C to -40°C to +85°C and back to +25°C. This is a typical value from a sample of parts put through such a cycle.

$$V_{o_HYS} = V_o(25^\circ C) - V_{o_TC}$$

$$V_{o_HYS} [ppm] = \frac{V_o(25^\circ C) - V_{o_TC}}{V_o(25^\circ C)} \times 10^6 \quad (2)$$

where:

$V_o(25^\circ C) = V_o$ at 25°C

$V_{o_TC} = V_o$ at 25°C after temperature cycle at +25°C to -40°C to +85°C and back to +25°C

APPLICATIONS SECTION

The ADR512 is a 1.2 V precision shunt voltage reference. It is designed to operate without an external output capacitor between the positive and negative terminals for stability. An external capacitor can be used for additional filtering of the supply.

As with all shunt voltage references, an external bias resistor (R_{BIAS}) is required between the supply voltage and the ADR512 (see Figure 2). R_{BIAS} sets the current that is required to pass through the load (I_L) and the ADR512 (I_Q). The load and the supply voltage can vary, thus R_{BIAS} is chosen based on

- R_{BIAS} must be small enough to supply the minimum I_Q current to the ADR512 even when the supply voltage is at its minimum and the load current is at its maximum value.
- R_{BIAS} also needs to be large enough so that I_Q does not exceed 10 mA when the supply voltage is at its maximum and the load current is at its minimum.

Given these conditions, R_{BIAS} is determined by the supply voltage (V_S), the load and operating current (I_L and I_Q) of the ADR512, and the ADR512's output voltage.

$$R_{BIAS} = (V_S - V_{OUT}) / (I_L + I_Q) \quad (3)$$

ADJUSTABLE PRECISION VOLTAGE SOURCE

The ADR512, combined with a precision low input bias op amp such as the AD8610, can be used to output a precise adjustable voltage. Figure 11 illustrates the implementation of this application using the ADR512.

The output of the op amp, V_{OUT} , is determined by the gain of the circuit, which is completely dependent on resistors R_2 and R_1 .

$$V_{OUT} = 1 + \frac{R_2}{R_1} \quad (4)$$

An additional capacitor in parallel with R_2 can be added to filter out high frequency noise. The value of C_2 is dependent on the value of R_2 .

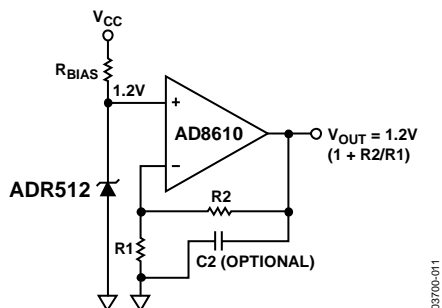

Figure 11. Adjustable Precision Voltage Source

OUTPUT VOLTAGE TRIM

Using a mechanical or digital potentiometer, the output voltage of the ADR512 can be trimmed $\pm 0.5\%$. The circuit in Figure 12 illustrates how the output voltage can be trimmed, using a 10 k Ω potentiometer.

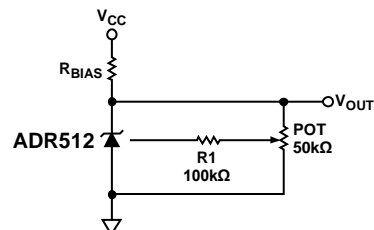

Figure 12. Output Voltage Trim

USING THE ADR512 WITH PRECISION DATA CONVERTERS

The compact ADR512 package and the device's low minimum operating current requirement make it ideal for use in battery powered portable instruments, such as the AD7533 CMOS multiplying DAC, that use precision data converters.

Figure 13 shows the ADR512 serving as an external reference to the AD7533, a CMOS multiplying DAC. Such a DAC requires a negative voltage input in order to provide a positive output range. In this application, the ADR512 is supplying a -1.2 V reference to the REF input of the AD7533.

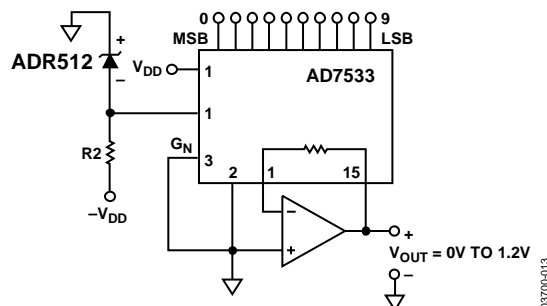

Figure 13. ADR512 as a Reference for a 10-Bit CMOS DAC (AD7533)

PRECISE NEGATIVE VOLTAGE REFERENCE

The ADR512 is suitable for use in applications where a precise negative voltage reference is desired, including the application detailed in Figure 13.

Figure 14 shows the ADR512 configured to provide a -1.2 V output.

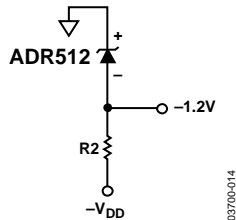

Figure 14. Precise -1.2 V Reference Configuration

Since the ADR512 characteristics resemble those of a Zener diode, the cathode shown in Figure 14 will be 1.2 V higher with respect to the anode ($V+$ with respect to $V-$ on the ADR512

package). Since the cathode of the ADR512 is tied to ground, the anode must be -1.2 V .

$R1$ in Figure 14 should be chosen so that $100\ \mu\text{A}$ to $10\ \text{mA}$ is provided to properly bias the ADR512.

$$R1 = \frac{V_{DD}}{I} \quad (5)$$

The resistor $R1$ should be chosen so that power dissipation is at a minimum. An ideal resistor value can be determined through manipulation of Equation 5.

OUTLINE DIMENSIONS

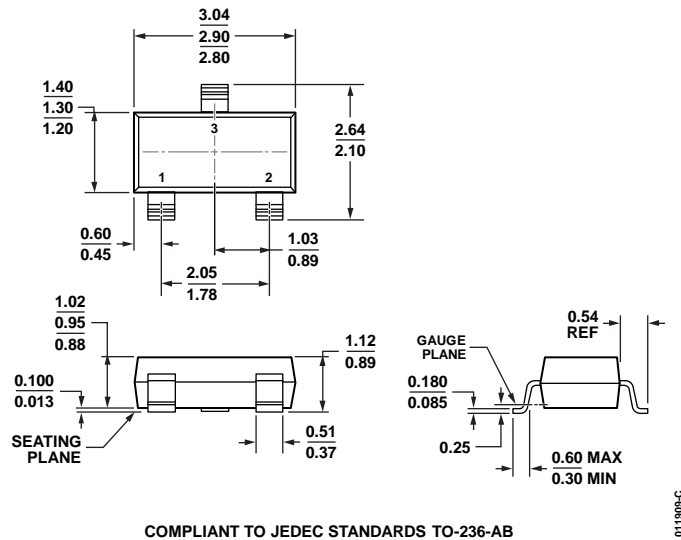

COMPLIANT TO JEDEC STANDARDS TO-236-AB
 Figure 15. 3-Lead Small Outline Transistor Package [SOT-23]
 (RT-3)
 Dimensions shown in millimeters

ORDERING GUIDE

Model	Output Voltage (V _o)	Initial Accuracy		Temperature Coefficient (ppm/°C)	Package Description	Package Option	Branding	Number of Parts per Reel	Temperature Range
		(mV)	(%)						
ADR512ARTZ-REEL7	1.2	3.5	0.3	60	3-Lead SOT-23	RT-3	R1R	3,000	-40°C to +85°C

NOTES

ADR512

Data Sheet

NOTES

OUR CERTIFICATE

DiGi provide top-quality products and perfect service for customer worldwide through standardization, technological innovation and continuous improvement. DiGi through third-party certification, we stricly control the quality of products and services. Welcome your RFQ to

Email: Info@DiGi-Electronics.com



Tel: +00 852-30501935

RFQ Email: Info@DiGi-Electronics.com

DiGi is a global authorized distributor of electronic components.