

ADUM2210SRIZ Datasheet

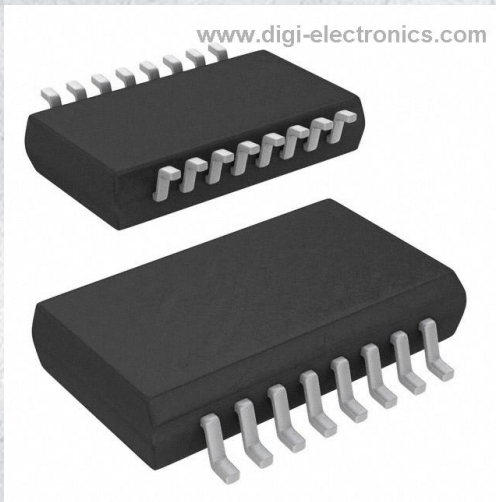

<https://www.DiGi-Electronics.com>

DiGi Electronics Part Number	ADUM2210SRIZ-DG
Manufacturer	Analog Devices Inc.
Manufacturer Product Number	ADUM2210SRIZ
Description	DGTL ISO 5000VRMS 2CH GP 16SOIC
Detailed Description	General Purpose Digital Isolator 5000Vrms 2 Channel 1Mbps 25kV/ μ s CMTI 16-SOIC (0.295", 7.50mm Width)



Tel: +00 852-30501935

RFQ Email: Info@DiGi-Electronics.com

DiGi is a global authorized distributor of electronic components.

Purchase and inquiry

Manufacturer Product Number:

ADUM2210SRIZ

Series:

iCoupler®

Technology:

Magnetic Coupling

Isolated Power:

No

Inputs - Side 1/Side 2:

2/0

Voltage - Isolation:

5000Vrms

Data Rate:

1Mbps

Pulse Width Distortion (Max):

40ns

Voltage - Supply:

3V ~ 5.5V

Mounting Type:

Surface Mount

Supplier Device Package:

16-SOIC-IC

Manufacturer:

Analog Devices Inc.

Product Status:

Active

Type:

General Purpose

Number of Channels:

2

Channel Type:

Unidirectional

Common Mode Transient Immunity (Min):

25kV/μs

Propagation Delay tpLH / tpHL (Max):

150ns, 150ns

Rise / Fall Time (Typ):

10ns, 10ns

Operating Temperature:

-40°C ~ 125°C

Package / Case:

16-SOIC (0.295", 7.50mm Width)

Base Product Number:

ADUM2210

Environmental & Export classification

RoHS Status:

ROHS3 Compliant

REACH Status:

REACH Unaffected

HTSUS:

8542.39.0001

Moisture Sensitivity Level (MSL):

3 (168 Hours)

ECCN:

EAR99

FEATURES

- ▶ High isolation voltage: 5000 V rms
- ▶ Enhanced system-level ESD performance per IEC 61000-4-x
- ▶ Low power operation
 - ▶ 5 V operation
 - ▶ 1.6 mA per channel maximum at 0 Mbps to 1 Mbps
 - ▶ 3.7 mA per channel maximum at 10 Mbps
 - ▶ 3.3 V operation
 - ▶ 1.4 mA per channel maximum at 0 Mbps to 1 Mbps
 - ▶ 2.4 mA per channel maximum at 10 Mbps
- ▶ Bidirectional communication
- ▶ 3.3 V/5 V level translation
- ▶ High temperature operation: 125°C
- ▶ Default low output
- ▶ High data rate: dc to 10 Mbps (NRZ)
- ▶ Precise timing characteristics
 - ▶ 3 ns maximum pulse width distortion
 - ▶ 3 ns maximum channel-to-channel matching
- ▶ High common-mode transient immunity: >25 kV/μs
- ▶ 16-lead SOIC wide body package version (RW-16)
- ▶ 16-lead SOIC wide body enhanced creepage version (RI-16)
- ▶ Safety and regulatory approvals (16-Lead-SOIC_IC/16-Lead-SO-IC_W)
 - ▶ UL 1577
 - ▶ $V_{ISO} = 5000$ V rms for 1 minute
 - ▶ IEC/EN/CSA 62368-1
 - ▶ IEC/CSA 60601-1
 - ▶ IEC/CSA 61010-1
 - ▶ CQC GB4943.1
 - ▶ DIN EN IEC 60747-17 (VDE 0884-17)
 - ▶ $V_{IORM} = 645$ V peak
- ▶ AEC-Q100 qualified for automotive applications

APPLICATIONS

- ▶ General-purpose, high voltage, multichannel isolation
- ▶ Medical equipment
- ▶ Power supplies
- ▶ RS-232/RS-422/RS-485 transceiver isolation
- ▶ Hybrid electric vehicles, battery monitors, and motor drives

FUNCTIONAL BLOCK DIAGRAMS

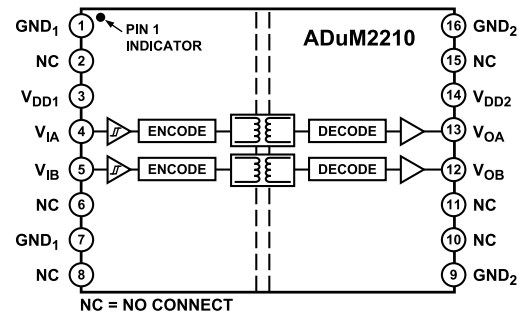

Figure 1. ADuM2210

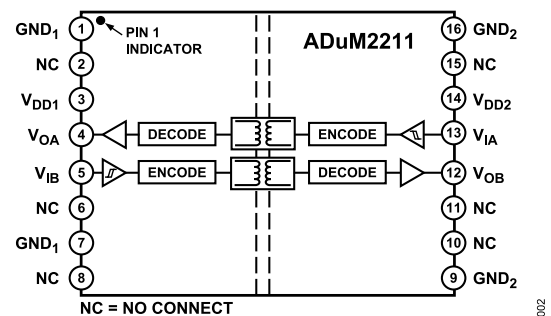

Figure 2. ADuM2211

TABLE OF CONTENTS

Features.....	1	Maximum Continuous Working Voltage.....	12
Applications.....	1	Truth Table.....	12
Functional Block Diagrams.....	1	Pin Configurations and Function Descriptions.....	14
General Description.....	3	Typical Performance Characteristics.....	16
Specifications.....	4	Applications Information.....	17
Electrical Characteristics—5 V Operation.....	4	PCB Layout.....	17
Electrical Characteristics—3.3 V Operation.....	5	Propagation Delay-Related Parameters.....	17
Electrical Characteristics—Mixed 5 V/3.3 V Operation.....	6	DC Correctness and Magnetic Field Immunity.....	17
Electrical Characteristics—Mixed 3.3 V/5 V Operation.....	7	Power Consumption.....	18
Package Characteristics.....	8	Insulation Lifetime.....	18
Regulatory Information.....	9	Outline Dimensions.....	20
Insulation and Safety-Related Specifications.....	9	Ordering Guide.....	20
DIN EN IEC 60747-17 (VDE 0884-17) Insulation Characteristics.....	10	Number of Inputs (V_{DD1} Side and V_{DD2} Side), Maximum Data Rate, Maximum Propagation Delay, and Maximum Pulse Width Distortion	20
Recommended Operating Conditions.....	11	Automotive Products.....	21
Absolute Maximum Ratings.....	12		
ESD Caution.....	12		

REVISION HISTORY**2/2025—Rev. F to Rev. G**

Changes to Features Section.....	1
Changes to Table 14.....	9
Changes to Table 15.....	9
Changed DIN V VDE V 0884-10 (VDE V 0884-10) Insulation Characteristics Section to DIN EN IEC 60747-17 (VDE 0884-17) Insulation Characteristics Section.....	10
Changes to DIN EN IEC 60747-17 (VDE 0884-17) Insulation Characteristics Section, Table 16, and Figure 3 Caption.....	10
Added Maximum Continuous Working Voltage Section.....	12
Replaced Table 19.....	12
Added Truth Table Section.....	12
Changes to Insulation Lifetime Section.....	18
Deleted Figure 16 to Figure 18.....	18

GENERAL DESCRIPTION

The ADuM2210/ADuM2211¹ are 2-channel digital isolators based on Analog Devices, Inc., *iCoupler*® technology. Combining high speed CMOS and monolithic air core transformer technology, these isolation components provide outstanding performance characteristics that are superior to alternatives such as optocoupler devices.

By avoiding the use of LEDs and photodiodes, *iCoupler* devices remove the design difficulties commonly associated with optocouplers.

Typical optocoupler concerns regarding uncertain current transfer ratios, nonlinear transfer functions, and temperature and lifetime effects are eliminated with the simple *iCoupler* digital interfaces and stable performance characteristics. The need for external drivers and other discrete components is eliminated with these *iCoupler* products. Furthermore, *iCoupler* devices run at one-tenth to one-sixth the power of optocouplers at comparable signal data rates.

The ADuM2210/ADuM2211 isolators provide two independent isolation channels in a variety of channel configurations and data rates (see the [Ordering Guide](#)). They operate with the supply voltage of either side ranging from 3.0 V to 5.5 V, providing compatibility with lower voltage systems as well as enabling voltage translation functionality across the isolation barrier. The ADuM2210W and ADuM2211W are automotive grade versions.

Similar to the [ADuM3200/ADuM3201](#) isolators, the ADuM2210/ADuM2211 isolators contain various circuit and layout enhancements to provide increased capability relative to system-level IEC 61000-4-x testing (ESD, burst, and surge). The precise capability in these tests for either the ADuM3200/ADuM3201 or ADuM2210/ADuM2211 products is strongly determined by the design and layout of the user's board or module. For more information, see the [AN-793 Application Note](#), *ESD/Latch-Up Considerations with iCoupler Isolation Products*.

¹ Protected by U.S. Patents 5,952,849; 6,873,065; 6,903,578; and 7,075,329. Other patents pending.

SPECIFICATIONS

ELECTRICAL CHARACTERISTICS—5 V OPERATION

All voltages are relative to their respective ground. $4.5\text{ V} \leq V_{DD1} \leq 5.5\text{ V}$, $4.5\text{ V} \leq V_{DD2} \leq 5.5\text{ V}$. All minimum/maximum specifications apply over the entire recommended operation range, $-40^\circ\text{C} \leq T_A \leq 125^\circ\text{C}$, unless otherwise noted. All typical specifications are at $T_A = 25^\circ\text{C}$, $V_{DD1} = V_{DD2} = 5\text{ V}$.

Table 1.

Parameter	Symbol	S Grade			T Grade			Unit	Test Conditions/Comments
		Min	Typ	Max	Min	Typ	Max		
SWITCHING SPECIFICATIONS									
Pulse Width	PW	1000			100			ns	Within PWD limit
Data Rate				1			10	Mbps	Within PWD limit
Propagation Delay	t_{PHL} , t_{PLH}	20		150	20		50	ns	50% input to 50% output
Pulse Width Distortion	PWD			40			3	ns	$ t_{PLH} - t_{PHL} $
Change vs. Temperature						5		ps/°C	
Propagation Delay Skew	t_{PSK}			100			15	ns	Between any two units
Channel Matching									
Codirectional	t_{PSKCD}			50			3	ns	
Opposing-Direction	t_{PSKOD}			50			17	ns	

Table 2.

Parameter	Symbol	1 Mbps, S Grade			10 Mbps, T Grade			Unit	Test Conditions/Comments
		Min	Typ	Max	Min	Typ	Max		
SUPPLY CURRENT									
ADuM2210	I_{DD1}		1.3	1.7		3.5	4.8	mA	No load
	I_{DD2}		1.0	1.6		1.7	2.8	mA	
ADuM2211	I_{DD1}		1.1	1.5		2.6	4.0	mA	
	I_{DD2}		1.3	1.8		3.1	4.1	mA	

Table 3.

Parameter	Symbol	Min	Typ	Max	Unit	Test Conditions/Comments ¹
DC SPECIFICATIONS						
Logic High Input Threshold	V_{IH}		$0.7V_{DDX}$		V	
Logic Low Input Threshold	V_{IL}				V	$0.3V_{DDX}$
Logic High Output Voltages	V_{OH}	$V_{DDX} - 0.1$	5.0		V	$I_{OX} = -20\ \mu\text{A}$, $V_{IX} = V_{IXH}$
		$V_{DDX} - 0.5$	4.8		V	$I_{OX} = -3.2\ \text{mA}$, $V_{IX} = V_{IXH}$
Logic Low Output Voltages	V_{OL}		0.0	0.1	V	$I_{OX} = 20\ \mu\text{A}$, $V_{IX} = V_{IXL}$
			0.2	0.4	V	$I_{OX} = 3.2\ \text{mA}$, $V_{IX} = V_{IXL}$
Input Current per Channel	I_I	-10	+0.01	+10	μA	$0\text{ V} \leq V_{IX} \leq V_{DDX}$
Supply Current per Channel						
Quiescent Input Supply Current	$I_{DD1(Q)}$		0.4	0.8	mA	
Quiescent Output Supply Current	$I_{DDO(Q)}$		0.5	0.6	mA	
Dynamic Input Supply Current	$I_{DD1(D)}$		0.19		mA/Mbps	
Dynamic Output Supply Current	$I_{DDO(D)}$		0.05		mA/Mbps	
AC SPECIFICATIONS						
Output Rise/Fall Time	t_R/t_F					
ADuM2210/ADuM2211 S Grade			10		ns	10% to 90%
ADuM2210/ADuM2211 T Grade			2.5		ns	10% to 90%
Common-Mode Transient Immunity ²	$ CM $	25	35		kV/ μs	$V_{IX} = V_{DDX}$, $V_{CM} = 1000\text{ V}$, transient magnitude = 800 V
Refresh Period	T_r		1.6		μs	

SPECIFICATIONS

¹ I_{Ox} is the Channel x output current, where x = A or B, V_{ixH} is the input side logic high, and V_{ixL} is the input side logic low.

² $|CM|$ is the maximum common-mode voltage slew rate that can be sustained while maintaining $V_O > 0.8 V_{DDx}$. The common-mode voltage slew rates apply to both rising and falling common-mode voltage edges.

ELECTRICAL CHARACTERISTICS—3.3 V OPERATION

All voltages are relative to their respective ground. $3.0 V \leq V_{DD1} \leq 3.6 V$, $3.0 V \leq V_{DD2} \leq 3.6 V$. All minimum/maximum specifications apply over the entire recommended operation range, $-40^\circ C \leq T_A \leq 125^\circ C$, unless otherwise noted. All typical specifications are at $T_A = 25^\circ C$, $V_{DD1} = V_{DD2} = 3.3 V$.

Table 4.

Parameter	Symbol	S Grade			T Grade			Unit	Test Conditions/Comments
		Min	Typ	Max	Min	Typ	Max		
SWITCHING SPECIFICATIONS									
Pulse Width	PW	1000			100			ns	Within PWD limit
Data Rate				1			10	Mbps	Within PWD limit
Propagation Delay	t_{PHL} , t_{PLH}	20		150	20		60	ns	50% input to 50% output
Pulse Width Distortion	PWD								$ t_{PLH} - t_{PHL} $
S Grade and T Grade				40			3	ns	
W Grade				40			4	ns	
Change vs. Temperature						5		ps/°C	
Propagation Delay Skew	t_{PSK}			100			22	ns	Between any two units
Channel Matching									
Codirectional	t_{PSKCD}			50			3	ns	
Opposing-Direction	t_{PSKOD}			50			22	ns	

Table 5.

Parameter	Symbol	1 Mbps, S Grade			10 Mbps, T Grade			Unit	Test Conditions/Comments
		Min	Typ	Max	Min	Typ	Max		
SUPPLY CURRENT									
ADuM2210	I_{DD1}		0.8	1.3		2.0	3.2	mA	No load
	I_{DD2}		0.7	1.0		1.1	1.9	mA	
ADuM2211	I_{DD1}		0.7	1.3		1.5	2.6	mA	
	I_{DD2}		0.8	1.6		1.9	2.5	mA	

Table 6.

Parameter	Symbol	Min	Typ	Max	Unit	Test Conditions/Comments ¹
DC SPECIFICATIONS						
Logic High Input Threshold	V_{IH}	$0.7V_{DDX}$			V	
Logic Low Input Threshold	V_{IL}				V	
Logic High Output Voltages	V_{OH}	$V_{DDX} - 0.1$	3.0		V	$I_{Ox} = -20 \mu A$, $V_{ix} = V_{ixH}$
		$V_{DDX} - 0.5$	2.8		V	$I_{Ox} = -3.2 \text{ mA}$, $V_{ix} = V_{ixH}$
Logic Low Output Voltages	V_{OL}		0.0	0.1	V	$I_{Ox} = 20 \mu A$, $V_{ix} = V_{ixL}$
			0.2	0.40	V	$I_{Ox} = 3.2 \text{ mA}$, $V_{ix} = V_{ixL}$
Input Current per Channel	I_I	-10	+0.01	+10	μA	$0 V \leq V_{ix} \leq V_{DDX}$
Supply Current per Channel						
Quiescent Input Supply Current	$I_{DD1(Q)}$		0.3	0.5	mA	
Quiescent Output Supply Current	$I_{DDO(Q)}$		0.3	0.5	mA	
Dynamic Input Supply Current	$I_{DD1(D)}$		0.10		mA/Mbps	
Dynamic Output Supply Current	$I_{DDO(D)}$		0.03		mA/Mbps	

SPECIFICATIONS

Table 6. (Continued)

Parameter	Symbol	Min	Typ	Max	Unit	Test Conditions/Comments ¹
AC SPECIFICATIONS						
Output Rise/Fall Time	t_R/t_F					
ADuM2210/ADuM2211 S Grade			10		ns	10% to 90%
ADuM2210/ADuM2211 T Grade			3		ns	10% to 90%
Common-Mode Transient Immunity ²	CM	25	35		kV/ μ s	$V_{IX} = V_{DDX}$, $V_{CM} = 1000$ V, transient magnitude = 800 V
Refresh Period	T_r		1.8		μ s	

¹ I_{OX} is the Channel x output current, where x = A or B, V_{IXH} is the input side logic high, and V_{IXL} is the input side logic low.

² |CM| is the maximum common-mode voltage slew rate that can be sustained while maintaining $V_O > 0.8 V_{DDX}$. The common-mode voltage slew rates apply to both rising and falling common-mode voltage edges.

ELECTRICAL CHARACTERISTICS—MIXED 5 V/3.3 V OPERATION

All voltages are relative to their respective ground. $4.5 \text{ V} \leq V_{DD1} \leq 5.5 \text{ V}$, $3.0 \text{ V} \leq V_{DD2} \leq 3.6 \text{ V}$. All minimum/maximum specifications apply over the entire recommended operation range, $-40^\circ\text{C} \leq T_A \leq 125^\circ\text{C}$, unless otherwise noted. All typical specifications are at $T_A = 25^\circ\text{C}$, $V_{DD1} = 5 \text{ V}$, $V_{DD2} = 3.3 \text{ V}$.

Table 7.

Parameter	Symbol	S Grade			T Grade			Unit	Test Conditions/Comments
		Min	Typ	Max	Min	Typ	Max		
SWITCHING SPECIFICATIONS									
Pulse Width	PW	1000			100			ns	Within PWD limit
Data Rate			1			10		Mbps	Within PWD limit
Propagation Delay	t_{PHL} , t_{PLH}	15	150		15	55		ns	50% input to 50% output
Pulse Width Distortion	PWD		40			3		ns	$ t_{PLH} - t_{PHL} $
S Grade and T Grade			40			3		ns	
W Grade			40			4		ns	
Change vs. Temperature						5		ps/ $^\circ\text{C}$	
Propagation Delay Skew	t_{PSK}		50			22		ns	Between any two units
Channel Matching									
Codirectional	t_{PSKCD}		50			3		ns	
Opposing-Direction	t_{PSKOD}		50			22		ns	

Table 8.

Parameter	Symbol	1 Mbps, S Grade			10 Mbps, T Grade			Unit	Test Conditions/Comments
		Min	Typ	Max	Min	Typ	Max		
SUPPLY CURRENT									
ADuM2210	I_{DD1}		1.3	1.7		3.5	4.8	mA	No load
	I_{DD2}		0.7	1.0		1.1	1.9	mA	
ADuM2211	I_{DD1}		1.1	1.5		2.6	4.0	mA	
	I_{DD2}		0.8	1.6		1.9	2.5	mA	

Table 9.

Parameter	Symbol	Min	Typ	Max	Unit	Test Conditions/Comments ¹
DC SPECIFICATIONS						
Logic High Input Threshold	V_{IH}	$0.7V_{DDX}$			V	
Logic Low Input Threshold	V_{IL}			$0.3V_{DDX}$	V	
Logic High Output Voltages	V_{OH}	$V_{DDX} - 0.1$	V_{DDX}		V	$I_{OX} = -20 \mu\text{A}$, $V_{IX} = V_{IXH}$

SPECIFICATIONS

Table 9. (Continued)

Parameter	Symbol	Min	Typ	Max	Unit	Test Conditions/Comments ¹
Logic Low Output Voltages	V_{OL}	$V_{DDX} - 0.5$	$V_{DDX} - 0.2$	0.1	V	$I_{OX} = -3.2 \text{ mA}$, $V_{IX} = V_{IXH}$
			0.0	0.1	V	$I_{OX} = 20 \text{ } \mu\text{A}$, $V_{IX} = V_{IXL}$
			0.2	0.40	V	$I_{OX} = 3.2 \text{ mA}$, $V_{IX} = V_{IXL}$
Input Current per Channel	I_I	-10	+0.01	+10	μA	$0 \text{ V} \leq V_{IX} \leq V_{DDX}$
Supply Current per Channel						
Quiescent Input Supply Current	$I_{DD1(Q)}$		0.4	0.8	mA	
Quiescent Output Supply Current	$I_{DD0(Q)}$		0.3	0.5	mA	
Dynamic Input Supply Current	$I_{DD1(D)}$		0.19		mA/Mbps	
Dynamic Output Supply Current	$I_{DD0(D)}$		0.03		mA/Mbps	
AC SPECIFICATIONS						
Output Rise/Fall Time	t_R/t_F					
ADuM2210/ADuM2211 S Grade			10		ns	10% to 90%
ADuM2210/ADuM2211 T Grade			3		ns	10% to 90%
Common-Mode Transient Immunity ²	$ CM $	25	35		kV/ μs	$V_{IX} = V_{DDX}$, $V_{CM} = 1000 \text{ V}$, transient magnitude = 800 V
Refresh Period	T_r		1.6		μs	

¹ I_{OX} is the Channel x output current, where x = A or B, V_{IXH} is the input side logic high, and V_{IXL} is the input side logic low.

² $|CM|$ is the maximum common-mode voltage slew rate that can be sustained while maintaining $V_O > 0.8 V_{DDX}$. The common-mode voltage slew rates apply to both rising and falling common-mode voltage edges.

ELECTRICAL CHARACTERISTICS—MIXED 3.3 V/5 V OPERATION

All voltages are relative to their respective ground. $3.0 \text{ V} \leq V_{DD1} \leq 3.6 \text{ V}$, $4.5 \text{ V} \leq V_{DD2} \leq 5.5 \text{ V}$. All minimum/maximum specifications apply over the entire recommended operation range, $-40^\circ\text{C} \leq T_A \leq 125^\circ\text{C}$, unless otherwise noted. All typical specifications are at $T_A = 25^\circ\text{C}$, $V_{DD1} = 3.3 \text{ V}$, $V_{DD2} = 5 \text{ V}$.

Table 10.

Parameter	Symbol	S Grade			T Grade			Unit	Test Conditions/Comments
		Min	Typ	Max	Min	Typ	Max		
SWITCHING SPECIFICATIONS									
Pulse Width	PW	1000			100			ns	Within PWD limit
Data Rate				1			10	Mbps	Within PWD limit
Propagation Delay	t_{PHL} , t_{PLH}	15		150	15		55	ns	50% input to 50% output
Pulse Width Distortion	PWD			40			3	ns	$ t_{PLH} - t_{PHL} $
S Grade and T Grade				40			3	ns	
W Grade				40			4	ns	
Change vs. Temperature						5		ps/ $^\circ\text{C}$	
Propagation Delay Skew	t_{PSK}			50			22	ns	Between any two units
Channel Matching									
Codirectional	t_{PSKCD}			50			3	ns	
Opposing-Direction	t_{PSKOD}			50			22	ns	

Table 11.

Parameter	Symbol	1 Mbps, S Grade			10 Mbps, T Grade			Unit	Test Conditions/Comments
		Min	Typ	Max	Min	Typ	Max		
SUPPLY CURRENT									
ADuM2210	I_{DD1}		0.8	1.3		2.0	3.2	mA	No load
	I_{DD2}		1.0	1.6		1.7	2.8	mA	

SPECIFICATIONS

Table 11. (Continued)

Parameter	Symbol	1 Mbps, S Grade			10 Mbps, T Grade			Unit	Test Conditions/Comments
		Min	Typ	Max	Min	Typ	Max		
ADuM2211	I _{DD1}		0.7	1.3		1.5	2.6	mA	
	I _{DD2}		1.3	1.8		3.1	4.1	mA	

Table 12.

Parameter	Symbol	Min	Typ	Max	Unit	Test Conditions/Comments ¹
DC SPECIFICATIONS						
Logic High Input Threshold	V _{IH}	0.7V _{DDX}			V	
Logic Low Input Threshold	V _{IL}				0.3V _{DDX}	V
Logic High Output Voltages	V _{OH}	V _{DDX} - 0.1	V _{DDX}		V	I _{Ox} = -20 μA, V _{Ix} = V _{IxH}
		V _{DDX} - 0.5	V _{DDX} - 0.2		V	
Logic Low Output Voltages	V _{OL}	0.0		0.1	V	I _{Ox} = 20 μA, V _{Ix} = V _{IxL}
		0.2		0.40	V	
Input Current per Channel	I _I	-10	+0.01	+10	μA	0 V ≤ V _{Ix} ≤ V _{DDX}
Supply Current per Channel						
Quiescent Input Supply Current	I _{DD1(Q)}		0.3	0.5	mA	
Quiescent Output Supply Current	I _{DD0(Q)}		0.5	0.6	mA	
Dynamic Input Supply Current	I _{DD1(D)}		0.10		mA/Mbps	
Dynamic Output Supply Current	I _{DD0(D)}		0.05		mA/Mbps	
AC SPECIFICATIONS						
Output Rise/Fall Time	t _R /t _F					
ADuM2210/ADuM2211 S Grade			10		ns	10% to 90%
ADuM2210/ADuM2211 T Grade			2.5			
Common-Mode Transient Immunity ²	CM	25	35		kV/μs	V _{Ix} = V _{DDX} , V _{CM} = 1000 V, transient magnitude = 800 V
Refresh Period	T _r		1.8		μs	

¹ I_{Ox} is the Channel x output current, where x = A or B, V_{IxH} is the input side logic high, and V_{IxL} is the input side logic low.

² |CM| is the maximum common-mode voltage slew rate that can be sustained while maintaining V_O > 0.8 V_{DDX}. The common-mode voltage slew rates apply to both rising and falling common-mode voltage edges.

PACKAGE CHARACTERISTICS

Table 13.

Parameter	Symbol	Min	Typ	Max	Unit	Test Conditions
Resistance (Input-to-Output) ¹	R _{I-O}		10 ¹²		Ω	
Capacitance (Input-to-Output) ¹	C _{I-O}		2.2		pF	f = 1 MHz
Input Capacitance ²	C _I		4.0		pF	
IC Junction-to-Case Thermal Resistance, Side 1	θ _{JCI}		33		°C/W	Thermocouple located at center of package underside
IC Junction-to-Case Thermal Resistance, Side 2	θ _{JCO}		28		°C/W	

¹ Device considered a 2-terminal device: Pin 1 through Pin 8 are shorted together and Pin 9 through Pin 16 are shorted together.

² Input capacitance is from any input data pin to ground.

SPECIFICATIONS

REGULATORY INFORMATION

The ADuM2210/ADuM2211 RI-16-2/RW-16 approvals are listed in [Table 14](#). Refer to [Table 19](#) and the [Insulation Lifetime](#) section for details regarding recommended maximum working voltages for specific cross-isolation waveforms and insulation levels.

Table 14.

UL	CSA	CQC	VDE
UL 1577 ¹ Single Protection 5000 V rms	RI-16-2 package IEC/EN/CSA 62368-1 Basic insulation, 870 V rms Reinforced insulation, 435 V rms IEC/CSA 60601-1 Reinforced insulation (2 MOPP), 250 V rms IEC/CSA 61010-1 Basic insulation, 600 V rms, Overvoltage Category IV Reinforced insulation, 300 V rms, Overvoltage Category II RW-16 package IEC/EN/CSA 62368-1 Basic insulation, 780 V rms Reinforced insulation, 390 V rms IEC/CSA 60601-1 Reinforced insulation (2 MOPP), 125 V rms IEC/CSA 61010-1 Basic insulation, 600 V rms, Overvoltage Category III Reinforced insulation, 300 V rms, Overvoltage Category II	RI-16-2 package CQC GB4943.1 Basic insulation, 820 V rms Reinforced insulation, 410 V rms RW-16 package CQC GB4943.1 Basic insulation, 760 V rms Reinforced insulation, 380 V rms	DIN EN IEC 60747-17 (VDE 0884-17) Reinforced insulation, 645 V peak ²
File E214100	File 205078	Certificate No. CQC17001164236	Certificate No. 40011599

¹ In accordance with UL 1577, each ADuM2210/ADuM2211 RI-16-2/RW-16 is proof tested by applying an insulation test voltage ≥ 6000 V rms for 1 second (current leakage detection limit = 10 μ A).

² In accordance with DIN EN IEC 60747-17 (VDE 0884-17) each ADuM2210/ADuM2211 is proof tested by applying an insulation test voltage ≥ 1209 V peak for 1 sec (partial discharge detection limit = 5 pC). The * marking branded on the component designates DIN EN IEC 60747-17 (VDE 0884-17) approval.

INSULATION AND SAFETY-RELATED SPECIFICATIONS

Table 15. RI-16-2/RW-16 Insulation and Safety-Related Specifications Table

Parameter	Symbol	Value	Unit	Conditions
Rated Dielectric Insulation Voltage		5000	V rms	1-minute duration
Minimum External Air Gap (Clearance) ^{1,2}	L(I01)			Distance measured from input terminals to output terminals, shortest distance through air along the PCB mounting plane, as an aid to PC board layout
RI-16-2		8.7	mm	
RW-16		7.8	mm	
Minimum External Tracking (Creepage) RI-16-2 Package ¹	L(I02)			Measured from input terminals to output terminals, shortest distance path along body
RI-16-2		8.7	mm	
RW-16		7.8	mm	
Minimum Internal Gap (Internal Clearance)		18	μ m	Insulation distance through insulation

SPECIFICATIONS

Table 15. RI-16-2/RW-16 Insulation and Safety-Related Specifications Table (Continued)

Parameter	Symbol	Value	Unit	Conditions
Tracking Resistance (Comparative Tracking Index) ³	CTI	>400	V	DIN IEC 112/VDE 0303 Part 1
Material Group		II		Material Group (DIN VDE 0110, 1/89, Table 1)

¹ In accordance with IEC 62368-1/IEC 60601-1 guidelines for the measurement of creepage and clearance distances for a pollution degree of 2 and altitudes ≤2000 m.

² Consideration must be given to pad layout to ensure the minimum required distance for clearance is maintained.

³ CTI rating for the ADuM2210/ADuM2211 RI-16-2/RW-16 is >400 V and a Material Group II isolation group.

DIN EN IEC 60747-17 (VDE 0884-17) INSULATION CHARACTERISTICS

These isolators are suitable for reinforced electrical isolation only within the safety limit data. Maintenance of the safety data is ensured by means of protective circuits. Note that the asterisk (*) branded on packages denotes DIN EN IEC 60747-17 (VDE 0884-17) approval.

Table 16.

Description	Test Conditions/Comments	Symbol	Characteristic	Unit
Installation Classification per DIN VDE 0110				
≤ 300 V rms			I to IV	
≤ 450 V rms			I to II	
≤ 600 V rms			I to II	
Climatic Classification			40/125/21	
Pollution Degree (DIN VDE 0110, Table 1)			2	
Maximum Repetitive Isolation Voltage		V_{IORM}	645	V peak
Maximum Working Insulation Voltage		V_{IOWM}	456	V rms
Input-to-Output Test Voltage, Method B1	$V_{IORM} \times 1.875 = V_{pd(m)}$, 100% production test, $t_m = 1$ sec, partial discharge < 5 pC	$V_{pd(m)}$	1209	V peak
Input-to-Output Test Voltage, Method A				
After Environmental Tests Subgroup 1	$V_{IORM} \times 1.6 = V_{pd(m)}$, $t_m = 60$ sec, partial discharge < 5 pC	$V_{pd(m)}$	1032	V peak
After Input and/or Safety Test Subgroup 2 and Subgroup 3	$V_{IORM} \times 1.2 = V_{pd(m)}$, $t_m = 60$ sec, partial discharge < 5 pC	$V_{pd(m)}$	774	V peak
Maximum Transient Isolation Voltage	$V_{TEST} = 1.2 \times V_{IOTM}$, $t = 1$ s (100% production)	V_{IOTM}	6000	V peak
Maximum Impulse Voltage	Surge voltage in air, waveform per IEC 61000-4-5	V_{IMP}	6000	V peak
Maximum Surge Isolation Voltage	$V_{TEST} \geq 1.3 \times V_{IMP}$ (sample test), tested in oil, waveform per IEC 61000-4-5	V_{IOSM}	10000	V peak
Safety-Limiting Values	Maximum value allowed in the event of a failure; see Figure 3			
Case Temperature		T_S	150	°C
Side 1 Current		I_{S1}	265	mA
Side 2 Current		I_{S2}	335	mA
Insulation Resistance at T_S	$V_{IO} = 500$ V	R_S	>10 ⁹	Ω

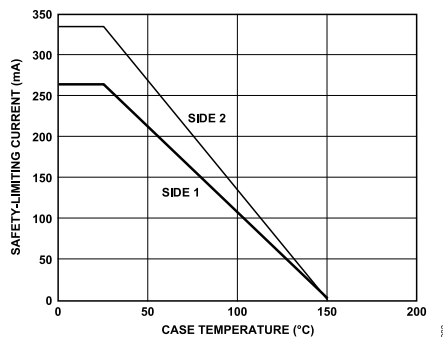

Figure 3. Thermal Derating Curve, Dependence of Safety Limiting Values with Case Temperature per DIN EN IEC 60747-17 (VDE 0884-17)

SPECIFICATIONS

RECOMMENDED OPERATING CONDITIONS

Table 17.

Parameter	Symbol	Min	Max	Unit
Operating Temperature	T_A	-40	+125	°C
Supply Voltages ¹	V_{DD1}, V_{DD2}	3.0	5.5	V
Input Signal Rise and Fall Times			1.0	ms

¹ All voltages are relative to their respective ground.

ABSOLUTE MAXIMUM RATINGS

Table 18.

Parameter	Rating
Storage Temperature (T_{ST})	-65°C to +150°C
Ambient Operating Temperature (T_A)	-40°C to +125°C
Supply Voltage (V_{DD1} , V_{DD2}) ¹	-0.5 V to +7.0 V
Input Voltage (V_{IA} , V_{IB}) ^{1,2}	-0.5 V to $V_{DD1} + 0.5$ V
Output Voltage (V_{OA} , V_{OB}) ^{1,2}	-0.5 V to $V_{DD0} + 0.5$ V
Average Output Current per Pin ³	
Side 1 (I_{O1})	-18 mA to +18 mA
Side 2 (I_{O2})	-22 mA to +22 mA
Common-Mode Transients ⁴	-100 kV/μs to +100 kV/μs

¹ All voltages are relative to their respective ground.

² V_{DD1} and V_{DD0} refer to the supply voltages on the input and output sides of a given channel, respectively. See the [PCB Layout](#) section.

³ See [Figure 3](#) for maximum rated current values for various temperatures.

⁴ Refers to common-mode transients across the insulation barrier. Common-mode transients exceeding the Absolute Maximum Rating can cause latch-up or permanent damage.

Stresses at or above those listed under Absolute Maximum Ratings may cause permanent damage to the product. This is a stress rating only; functional operation of the product at these or any other conditions above those indicated in the operational section of this specification is not implied. Operation beyond the maximum operating conditions for extended periods may affect product reliability.

ESD CAUTION



ESD (electrostatic discharge) sensitive device. Charged devices and circuit boards can discharge without detection. Although this product features patented or proprietary protection circuitry, damage may occur on devices subjected to high energy ESD. Therefore, proper ESD precautions should be taken to avoid performance degradation or loss of functionality.

MAXIMUM CONTINUOUS WORKING VOLTAGE

Table 19. Maximum Continuous Working Voltage¹

Parameter	Max	Unit	Constraint
AC Voltage			
Bipolar Waveform	645	V peak	Reinforced insulation rating as per IEC 60747-17 (VDE 0884-17)

¹ Refers to continuous voltage magnitude imposed across the isolation barrier. See the [Insulation Lifetime](#) section for more details

TRUTH TABLE

Table 20. ADuM2210 Truth Table (Positive Logic)

V_{IA} Input ¹	V_{IB} Input ¹	V_{DD1} State	V_{DD2} State	V_{OA} Output ¹	V_{OB} Output ¹	Notes
H	H	Powered	Powered	H	H	
L	L	Powered	Powered	L	L	
H	L	Powered	Powered	H	L	
L	H	Powered	Powered	L	H	
X	X	Unpowered	Powered	L	L	Outputs return to the input state within 1 μs of V_{DD1} power restoration.
X	X	Powered	Unpowered	Indeterminate	Indeterminate	Outputs return to the input state within 1 μs of V_{DD0} power restoration.

¹ H is logic high, L is logic low, and X is don't care.

Table 21. ADuM2211 Truth Table (Positive Logic)

V_{IA} Input ¹	V_{IB} Input ¹	V_{DD1} State	V_{DD2} State	V_{OA} Output ¹	V_{OB} Output ¹	Notes
H	H	Powered	Powered	H	H	
L	L	Powered	Powered	L	L	
H	L	Powered	Powered	H	L	
L	H	Powered	Powered	L	H	

ABSOLUTE MAXIMUM RATINGS

Table 21. ADuM2211 Truth Table (Positive Logic) (Continued)

V_{IA} Input ¹	V_{IB} Input ¹	V_{DD1} State	V_{DD2} State	V_{OA} Output ¹	V_{OB} Output ¹	Notes
X	X	Unpowered	Powered	Indeterminate	L	Outputs return to the input state within 1 μ s of V_{DD1} power restoration.
X	X	Powered	Unpowered	L	Indeterminate	Outputs return to the input state within 1 μ s of V_{DD0} power restoration.

¹ H is logic high, L is logic low, and X is don't care.

PIN CONFIGURATIONS AND FUNCTION DESCRIPTIONS

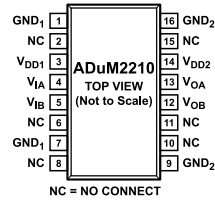

NC = NO CONNECT

NOTES:
 1. PIN 1 AND PIN 7 ARE INTERNALLY CONNECTED, AND CONNECTING BOTH TO GND₁ IS RECOMMENDED.
 2. PIN 9 AND PIN 16 ARE INTERNALLY CONNECTED, AND CONNECTING BOTH TO GND₂ IS RECOMMENDED.

Figure 4. ADuM2210 Pin Configuration

Table 22. ADuM2210 Pin Function Descriptions

Pin No.	Mnemonic	Description
1	GND ₁	Ground 1. Ground reference for Isolator Side 1.
2	NC	No internal connection.
3	V _{DD1}	Supply Voltage for Isolator Side 1, 3.0 V to 5.5 V.
4	V _{IA}	Logic Input A.
5	V _{IB}	Logic Input B.
6	NC	No internal connection.
7	GND ₁	Ground 1. Ground reference for Isolator Side 1.
8	NC	No internal connection.
9	GND ₂	Ground 2. Ground reference for Isolator Side 2.
10	NC	No internal connection.
11	NC	No internal connection.
12	V _{OB}	Logic Output B.
13	V _{OA}	Logic Output A.
14	V _{DD2}	Supply Voltage for Isolator Side 2, 3.0 V to 5.5 V.
15	NC	No internal connection.
16	GND ₂	Ground 2. Ground reference for Isolator Side 2.

PIN CONFIGURATIONS AND FUNCTION DESCRIPTIONS

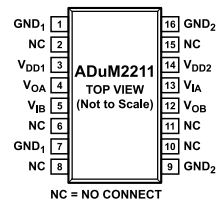

NOTES:
 1. PIN 1 AND PIN 7 ARE INTERNALLY CONNECTED, AND CONNECTING BOTH TO GND₁ IS RECOMMENDED.
 2. PIN 9 AND PIN 16 ARE INTERNALLY CONNECTED, AND CONNECTING BOTH TO GND₂ IS RECOMMENDED.

Figure 5. ADuM2211 Pin Configuration

Table 23. ADuM2211 Pin Function Descriptions

Pin No.	Mnemonic	Description
1	GND ₁	Ground 1. Ground reference for Isolator Side 1.
2	NC	No internal connection.
3	V _{DD1}	Supply Voltage for Isolator Side 1, 3.0 V to 5.5 V.
4	V _{OA}	Logic Output A.
5	V _{IB}	Logic Input B.
6	NC	No internal connection.
7	GND ₁	Ground 1. Ground reference for Isolator Side 1.
8	NC	No internal connection.
9	GND ₂	Ground 2. Ground reference for Isolator Side 2.
10	NC	No internal connection.
11	NC	No internal connection.
12	V _{OB}	Logic Output B.
13	V _{IA}	Logic Input A.
14	V _{DD2}	Supply Voltage for Isolator Side 2, 3.0 V to 5.5 V.
15	NC	No internal connection.
16	GND ₂	Ground 2. Ground reference for Isolator Side 2.

TYPICAL PERFORMANCE CHARACTERISTICS

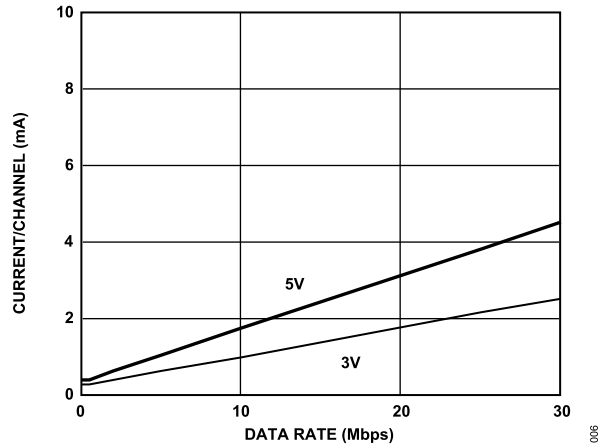

Figure 6. Typical Input Supply Current per Channel vs. Data Rate for 5 V and 3.3 V Operation (No Output Load)

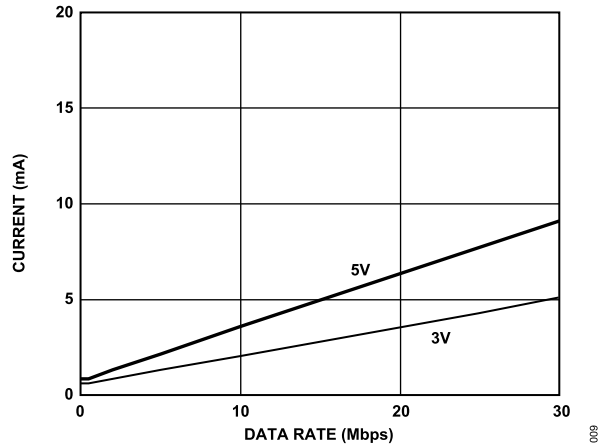

Figure 9. Typical ADuM2210 V_{DD1} Supply Current vs. Data Rate for 5 V and 3.3 V Operation

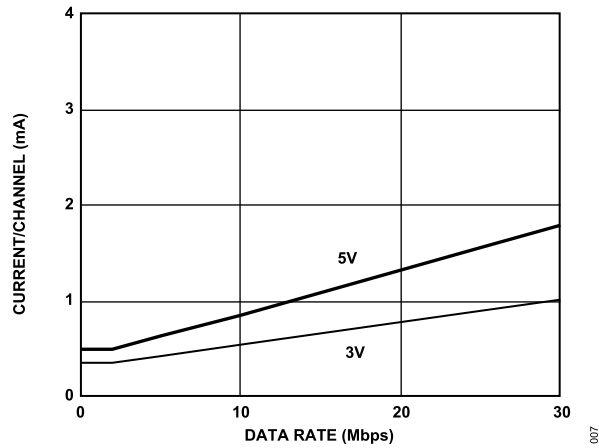

Figure 7. Typical Output Supply Current per Channel vs. Data Rate for 5 V and 3.3 V Operation (No Output Load)

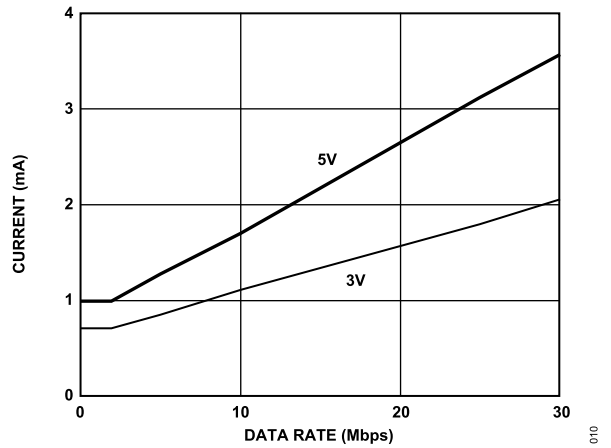

Figure 10. Typical ADuM2210 V_{DD2} Supply Current vs. Data Rate for 5 V and 3.3 V Operation

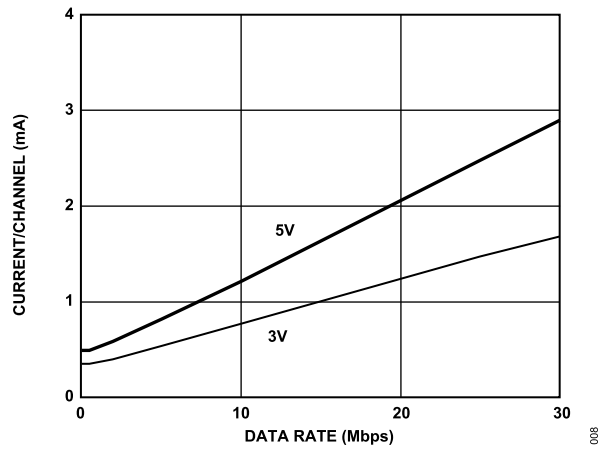

Figure 8. Typical Output Supply Current per Channel vs. Data Rate for 5 V and 3.3 V Operation (15 pF Output Load)

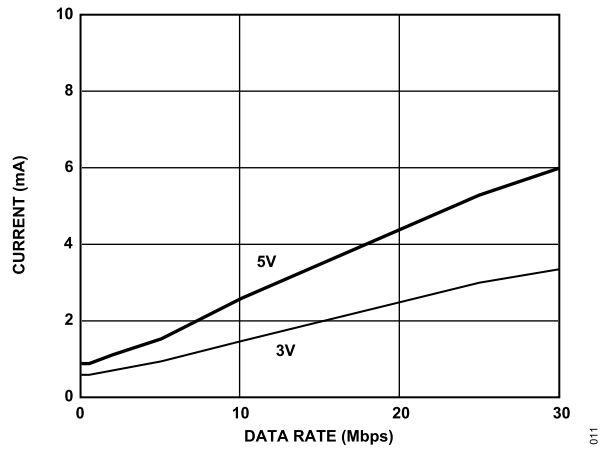

Figure 11. Typical ADuM2211 V_{DD1} or V_{DD2} Supply Current vs. Data Rate for 5 V and 3.3 V Operation

APPLICATIONS INFORMATION

PCB LAYOUT

The ADuM2210/ADuM2211 digital isolator requires no external interface circuitry for the logic interfaces. Power supply bypassing is strongly recommended at the input and output supply pins (see [Figure 12](#)). Bypass capacitors are most conveniently connected between Pin 1 and Pin 3 for V_{DD1} and between Pin 14 and Pin 16 for V_{DD2} . The capacitor value should be between 0.01 μF and 0.1 μF . The total lead length between both ends of the capacitor and the input power supply pin should not exceed 20 mm. Bypassing between Pin 3 and Pin 7 and between Pin 9 and Pin 14 should be considered unless the ground pair on each package side is connected close to the package.

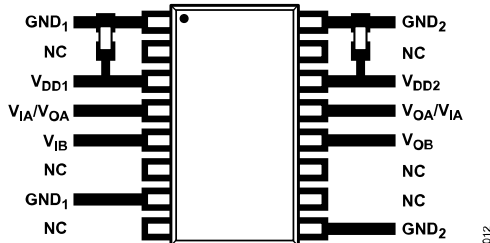

Figure 12. Recommended Printed Circuit Board Layout

In applications involving high common-mode transients, care should be taken to ensure that board coupling across the isolation barrier is minimized. Furthermore, the board layout should be designed such that any coupling that does occur equally affects all pins on a given component side. Failure to ensure this could cause voltage differentials between pins exceeding the [Absolute Maximum Ratings](#) of the device, thereby leading to latch-up or permanent damage.

See the [AN-1109 Application Note](#) for board layout guidelines.

PROPAGATION DELAY-RELATED PARAMETERS

Propagation delay is a parameter that describes the length of time it takes for a logic signal to propagate through a component. The propagation delay to a logic low output can differ from the propagation delay to logic high.

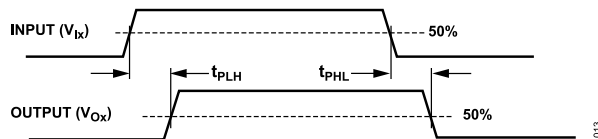

Figure 13. Propagation Delay Parameters

Pulse width distortion is the maximum difference between these two propagation delay values and is an indication of how accurately the input signal's timing is preserved.

Channel-to-channel matching refers to the maximum amount the propagation delay differs among channels within a single ADuM2210/ADuM2211 component.

Propagation delay skew refers to the maximum amount the propagation delay differs among multiple ADuM2210/ADuM2211 components operated under the same conditions.

DC CORRECTNESS AND MAGNETIC FIELD IMMUNITY

Positive and negative logic transitions at the isolator input cause narrow (~ 1 ns) pulses to be sent via the transformer to the decoder. The decoder is bistable and is, therefore, either set or reset by the pulses, indicating input logic transitions. In the absence of logic transitions at the input for more than ~ 1 μs , a periodic set of refresh pulses indicative of the correct input state is sent to ensure dc correctness at the output. If the decoder receives no internal pulses for more than approximately 5 μs , the input side is assumed to be without power or nonfunctional; in which case, the isolator output is forced to a default state (see [Table 20](#) and [Table 21](#)) by the watchdog timer circuit.

The limitation on the ADuM2210/ADuM2211 magnetic field immunity is set by the condition in which induced voltage in the transformer receiving coil is large enough to either falsely set or reset the decoder. The following analysis defines the conditions under which this can occur. The 3.3 V operating condition of the ADuM2210/ADuM2211 is examined because it represents the most susceptible mode of operation.

The pulses at the transformer output have an amplitude greater than 1.0 V. The decoder has a sensing threshold at about 0.5 V, therefore establishing a 0.5 V margin in which induced voltages can be tolerated. The voltage induced across the receiving coil is given by

$$V = (-d\beta/dt)\Sigma\pi r_n^2; n = 1, 2, \dots, N \quad (1)$$

where:

β is the magnetic flux density (gauss).

N is the number of turns in the receiving coil.

r_n is the radius of the n^{th} turn in the receiving coil (cm).

Given the geometry of the receiving coil in the ADuM2210/ADuM2211 and an imposed requirement that the induced voltage be at most 50% of the 0.5 V margin at the decoder, a maximum allowable magnetic field is calculated as shown in [Figure 14](#).

APPLICATIONS INFORMATION

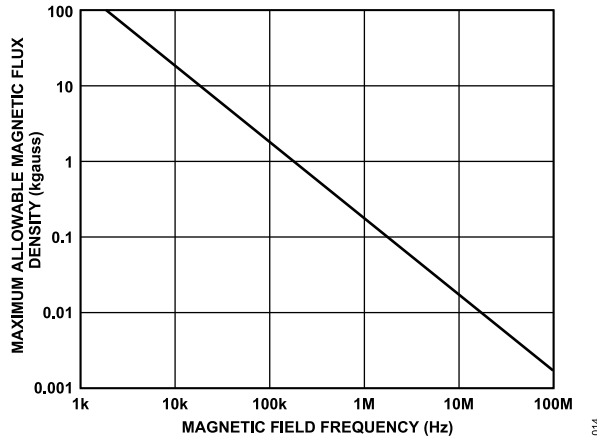

Figure 14. Maximum Allowable External Magnetic Flux Density

For example, at a magnetic field frequency of 1 MHz, the maximum allowable magnetic field of 0.2 kgauss induces a voltage of 0.25 V at the receiving coil. This is about 50% of the sensing threshold and does not cause a faulty output transition. Similarly, if such an event were to occur during a transmitted pulse (and was of the worst-case polarity), it would reduce the received pulse from >1.0 V to 0.75 V—still well above the 0.5 V sensing threshold of the decoder.

The preceding magnetic flux density values correspond to specific current magnitudes at given distances away from the ADuM2210/ADuM2211 transformers. Figure 15 expresses these allowable current magnitudes as a function of frequency for selected distances. As can be seen, the ADuM2210/ADuM2211 is immune and can be affected only by extremely large currents operated at high frequency and very close to the component. For the 1 MHz example noted previously, one would have to place a 0.5 kA current 5 mm away from the ADuM2210/ADuM2211 to affect operation of the component.

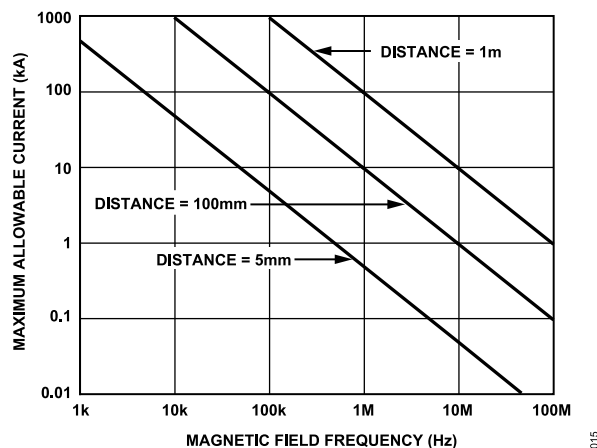

Figure 15. Maximum Allowable Current for Various Current-to-ADuM2210/ADuM2211 Spacings

Note that at combinations of strong magnetic field and high frequency, any loops formed by printed circuit board traces can induce sufficiently large error voltages to trigger the thresholds of succeed-

ing circuitry. Care should be taken in the layout of such traces to avoid this possibility.

POWER CONSUMPTION

The supply current at a given channel of the ADuM2210/ADuM2211 isolator is a function of the supply voltage, the channel's data rate, and the channel's output load.

For each input channel, the supply current is given by

$$I_{DDI} = I_{DDI(Q)} \quad f \leq 0.5f_r \quad (2)$$

$$I_{DDI} = I_{DDI(D)} \times (2f - f_r) + I_{DDI(Q)} \quad f > 0.5f_r \quad (3)$$

For each output channel, the supply current is given by

$$I_{DDO} = I_{DDO(Q)} \quad f \leq 0.5f_r \quad (4)$$

$$I_{DDO} = (I_{DDO(D)} + (0.5 \times 10^{-3}) \times C_L \times V_{DDO}) \times (2f - f_r) + I_{DDO(Q)} \quad (5)$$

$$f > 0.5f_r \quad (6)$$

where:

$I_{DDI(D)}$, $I_{DDO(D)}$ are the input and output dynamic supply currents per channel (mA/Mbps).

C_L is the output load capacitance (pF).

V_{DDO} is the output supply voltage (V).

f is the input logic signal frequency (MHz, half of the input data rate, NRZ signaling).

f_r is the input stage refresh rate (Mbps).

$I_{DDI(Q)}$, $I_{DDO(Q)}$ are the specified input and output quiescent supply currents (mA).

To calculate the total I_{DD1} and I_{DD2} , the supply currents for each input and output channel corresponding to I_{DD1} and I_{DD2} are calculated and totaled. Figure 6 and Figure 7 provide per-channel supply currents as a function of data rate for an unloaded output condition. Figure 8 provides per-channel supply current as a function of data rate for a 15 pF output condition. Figure 9 through Figure 11 provide total I_{DD1} and I_{DD2} as a function of data rate for ADuM2210/ADuM2211 channel configurations.

INSULATION LIFETIME

All insulation structures eventually break down when subjected to voltage stress over a sufficiently long period. The rate of insulation degradation is dependent on the characteristics of the voltage waveform applied across the insulation. In addition to the testing performed by the regulatory agencies, Analog Devices carries out an extensive set of evaluations to determine the lifetime of the insulation structure within the ADuM2210/ADuM2211.

Analog Devices performs accelerated life testing using voltage levels higher than the rated continuous working voltage. Acceleration factors for several operating conditions are determined. These factors allow calculation of the time to failure at the actual working voltage. The values shown in Table 19 summarize the maximum continuous working voltages as per IEC 60747-17. Operation at

APPLICATIONS INFORMATION

working voltages higher than the service life voltage listed leads to premature insulation failure.

OUTLINE DIMENSIONS

Package Drawing (Option)	Package Type	Package Description
RW-16	SOIC_W	16-Lead Standard Small Outline Package, Wide Body
RI-16-2	SOIC_IC	16-Lead Standard Small Outline Package with Increased Creepage, Wide Body

For the latest package outline information and land patterns (footprints), go to [Package Index](#).

ORDERING GUIDE

Model ^{1, 2, 3}	Temperature Range	Package Description	Packing Quantity	Package Option
ADuM2210SRIZ	-40°C to +125°C	16-Lead SOIC_IC	Tube, 37	RI-16-2
ADuM2210SRWZ	-40°C to +125°C	16-Lead SOIC_W	Tube, 47	RW-16
ADuM2210WSRWZ	-40°C to +125°C	16-Lead SOIC_W	Tube, 47	RW-16
ADuM2210TRIZ	-40°C to +125°C	16-Lead SOIC_IC	Tube, 37	RI-16-2
ADuM2210TRWZ	-40°C to +125°C	16-Lead SOIC_W	Tube, 47	RW-16
ADuM2210WTRWZ	-40°C to +125°C	16-Lead SOIC_W	Tube, 47	RW-16
ADuM2211SRIZ	-40°C to +125°C	16-Lead SOIC_IC	Tube, 37	RI-16-2
ADuM2211SRWZ	-40°C to +125°C	16-Lead SOIC_W	Tube, 47	RW-16
ADuM2211WSRWZ	-40°C to +125°C	16-Lead SOIC_W	Tube, 47	RW-16
ADuM2211TRWZ	-40°C to +125°C	16-Lead SOIC_W	Tube, 47	RW-16
ADuM2211WTRWZ	-40°C to +125°C	16-Lead SOIC_W	Tube, 47	RW-16
ADuM2211TRIZ	-40°C to +125°C	16-Lead SOIC_IC	Tube, 37	RI-16-2

¹ Z = RoHS Compliant Part.

² Tape and reel is available. The addition of an -RL suffix designates a 13" (1,000 units) tape and reel option.

³ W = Qualified for Automotive Applications.

NUMBER OF INPUTS (V_{DD1} SIDE AND V_{DD2} SIDE), MAXIMUM DATA RATE, MAXIMUM PROPAGATION DELAY, AND MAXIMUM PULSE WIDTH DISTORTION

Model ^{1, 2, 3}	Number of Inputs, V_{DD1} Side	Number of Inputs, V_{DD2} Side	Maximum Data Rate (Mbps)	Maximum Propagation Delay, 5 V (ns)	Maximum Pulse Width Distortion (ns)
ADuM2210SRIZ	2	0	1	150	40
ADuM2210SRWZ	2	0	1	150	40
ADuM2210WSRWZ	2	0	1	150	40
ADuM2210TRIZ	2	0	10	50	3
ADuM2210TRWZ	2	0	10	50	3
ADuM2210WTRWZ	2	0	10	50	3
ADuM2211SRIZ	1	1	1	150	40
ADuM2211SRWZ	1	1	1	150	40
ADuM2211WSRWZ	1	1	1	150	40
ADuM2211TRWZ	1	1	10	50	3
ADuM2211WTRWZ	1	1	10	50	3
ADuM2211TRIZ	1	1	10	50	3

¹ Z = RoHS Compliant Part.

² Tape and reel is available. The addition of an -RL suffix designates a 13" (1,000 units) tape and reel option.

³ W = Qualified for Automotive Applications.

OUTLINE DIMENSIONS

AUTOMOTIVE PRODUCTS

The ADuM2210W/ADuM2211W models are available with controlled manufacturing to support the quality and reliability requirements of automotive applications. Note that these automotive models may have specifications that differ from the commercial models; therefore, designers should review the [Specifications](#) section of this data sheet carefully. Only the automotive grade products shown are available for use in automotive applications. Contact your local Analog Devices account representative for specific product ordering information and to obtain the specific Automotive Reliability reports for these models.

OUR CERTIFICATE

DiGi provide top-quality products and perfect service for customer worldwide through standardization, technological innovation and continuous improvement. DiGi through third-party certification, we stricly control the quality of products and services. Welcome your RFQ to

Email: Info@DiGi-Electronics.com



Tel: +00 852-30501935

RFQ Email: Info@DiGi-Electronics.com

DiGi is a global authorized distributor of electronic components.