

HMC787AG Datasheet

www.digi-electronics.com

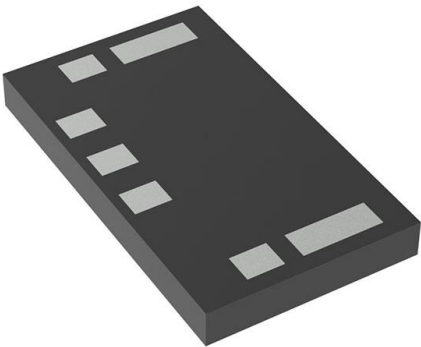

<https://www.DiGi-Electronics.com>

DiGi Electronics Part Number	HMC787AG-DG
Manufacturer	Analog Devices Inc.
Manufacturer Product Number	HMC787AG
Description	MIXERS
Detailed Description	RF Mixer IC ISM, UWB Down Converter 3GHz ~ 10GHz Die

This model HMC787AG is available at DiGi Electronics.

DiGi Electronics offers a global database of semiconductor and electronic component datasheets.

We welcome your inquiries regarding pricing, lead time, or other product-related questions.

 [Request a Quote](#)

 [Datasheet Search](#)



Tel: +00 852-30501935

RFQ Email: Info@DiGi-Electronics.com

DiGi is a global authorized distributor of electronic components.

Purchase and inquiry

Manufacturer Product Number:

HMC787AG

Series:

-

RF Type:

ISM, UWB

Number of Mixers:

1

Noise Figure:

10dB

Current - Supply:

-

Mounting Type:

Surface Mount

Supplier Device Package:

Die

Manufacturer:

Analog Devices Inc.

Product Status:

Active

Frequency:

3GHz ~ 10GHz

Gain:

-

Secondary Attributes:

Down Converter

Voltage - Supply:

-

Package / Case:

Die

Environmental & Export classification

RoHS Status:

ROHS3 Compliant

REACH Status:

REACH Unaffected

HTSUS:

8542.39.0001

Moisture Sensitivity Level (MSL):

1 (Unlimited)

ECCN:

EAR99



GaAs, MMIC, Fundamental Mixer, 3 GHz to 10 GHz

Data Sheet

HMC787A

FEATURES

- Conversion loss: 9 dB typical at 3 GHz to 9 GHz**
- Local oscillator (LO) to radio frequency (RF) isolation:
43 dB typical at 3 GHz to 9 GHz**
- RF to intermediate frequency (IF) isolation: 26 dB typical at
3 GHz to 9 GHz**
- Input third-order intercept (IP3): 24 dBm typical at
3 GHz to 9 GHz**
- Input 1 dB compression point (P1dB): 17 dBm typical at
3 GHz to 9 GHz**
- Input second-order intercept (IP2): 67 dBm typical at
3 GHz to 9 GHz**
- Passive double-balanced topology**
- Wide IF frequency range: dc to 4 GHz**
- 12-terminal, ceramic, leadless chip carrier (LCC) package**

APPLICATIONS

- Microwave radio**
- Industrial, scientific, and medical (ISM) band and ultrawide
band (UWB) radio**
- Test equipment and sensors**
- Military end use**

GENERAL DESCRIPTION

The [HMC787A](#) is a general-purpose, double balanced mixer in a 12-terminal, RoHS compliant, ceramic leadless chip carrier (LCC) package that can be used as an upconverter or down-converter from 3 GHz to 10 GHz. This mixer is fabricated in a gallium arsenide (GaAs), metal semiconductor field effect transistor (MESFET) process and requires no external components or matching circuitry.

FUNCTIONAL BLOCK DIAGRAM

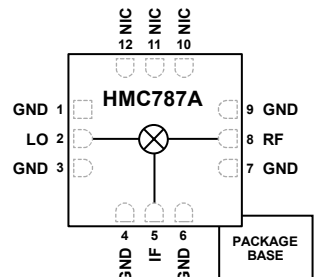

Figure 1.

The [HMC787A](#) provides excellent local oscillator (LO) to radio frequency (RF) and LO to intermediate frequency (IF) isolation due to optimized balun structures and operates with a LO drive level of 17 dBm. The ceramic LCC package eliminates the need for wire bonding and is compatible with high volume, surface-mount manufacturing techniques.

Rev. C

[Document Feedback](#)

Information furnished by Analog Devices is believed to be accurate and reliable. However, no responsibility is assumed by Analog Devices for its use, nor for any infringements of patents or other rights of third parties that may result from its use. Specifications subject to change without notice. No license is granted by implication or otherwise under any patent or patent rights of Analog Devices. Trademarks and registered trademarks are the property of their respective owners.

One Technology Way, P.O. Box 9106, Norwood, MA 02062-9106, U.S.A.
Tel: 781.329.4700 ©2016–2017 Analog Devices, Inc. All rights reserved.
[Technical Support](#) www.analog.com

TABLE OF CONTENTS

Features	1	Downconverter Performance	6
Applications.....	1	Upconverter Performance.....	10
Functional Block Diagram	1	Isolation and Return Loss Performance.....	12
General Description	1	Spurious and Harmonics Performance	14
Revision History	2	Theory of Operation	15
Specifications.....	3	Applications Information	16
Absolute Maximum Ratings.....	4	Typical Application Circuit.....	16
Thermal Resistance	4	Evaluation PCB Information	16
ESD Caution.....	4	Outline Dimensions	17
Pin Configuration and Function Descriptions.....	5	Ordering Guide	17
Interface Schematics.....	5		
Typical Performance Characteristics	6		

REVISION HISTORY**9/2017—Rev. B to Rev. C**

Changes to Table 4..... 5

5/2017—Rev. A to Rev. B

Changed E-12-1 to E-12-4..... Throughout

Change to Figure 1

Change to Figure 2

Updated Outline Dimensions

Changes to Ordering Guide

2/2017—Rev. 0 to Rev. A

Changes to Storage Temperature Range Parameter, Table 2..... 4

10/2016—Revision 0: Initial Version

Rev. C | Page 2 of 17

SPECIFICATIONS

$T_A = 25^\circ\text{C}$, IF = 100 MHz, LO = 17 dBm, and all measurements performed as downconverter, unless otherwise noted.

Table 1.

Parameter	Min	Typ	Max	Unit
FREQUENCY RANGE				
RF	3		10	GHz
LO	3		10	GHz
IF	DC		4	GHz
LO DRIVE LEVEL		17		dBm
PERFORMANCE AT RF = 3 GHz to 9 GHz				
Conversion Loss		9	11	dB
Single Sideband (SSB) Noise Figure		9		dB
Input Third-Order Intercept (IP3)	15	24		dBm
Input 1 dB Compression Point (P1dB)		17		dBm
Input Second-Order Intercept (IP2)		67		dB
RF to IF Isolation	15	26		dB
LO to RF Isolation		48		dB
LO to IF Isolation	35	43		dB
PERFORMANCE AT RF = 9 GHz to 10 GHz				
Conversion Loss		9	11	dB
SSB Noise Figure		9		dB
Input IP3	15	24		dBm
Input P1dB		15		dBm
Input IP2		66		dB
RF to IF Isolation	15	26		dB
LO to RF Isolation		47		dB
LO to IF Isolation	25	42		dB

ABSOLUTE MAXIMUM RATINGS

Table 2.

Parameter	Rating
RF Input Power	28 dBm
LO Input Power	28 dBm
IF Input Power	28 dBm
IF Source and Sink Current	12 mA
Continuous Power Dissipation, P_{DISS} ($T_A = 85^\circ\text{C}$, Derate 11.6 mW/ $^\circ\text{C}$ Above 85 $^\circ\text{C}$)	1044 mW
Maximum Junction Temperature	175 $^\circ\text{C}$
Maximum Peak Reflow Temperature (MSL3) ¹	260 $^\circ\text{C}$
Operating Temperature Range	-40 $^\circ\text{C}$ to +85 $^\circ\text{C}$
Storage Temperature Range	-65 $^\circ\text{C}$ to +150 $^\circ\text{C}$
Electrostatic Discharge (ESD) Sensitivity	
Human Body Model (HBM)	1500 V (Class 1C)
Field Induced Charged Device Model (FICDM)	1000 V (Class C5)

¹ See the Ordering Guide section.

Stresses at or above those listed under Absolute Maximum Ratings may cause permanent damage to the product. This is a stress rating only; functional operation of the product at these or any other conditions above those indicated in the operational section of this specification is not implied. Operation beyond the maximum operating conditions for extended periods may affect product reliability.

THERMAL RESISTANCE

Thermal performance is directly linked to printed circuit board (PCB) design and operating environment. Careful attention to PCB thermal design is required.

Table 3. Thermal Resistance

Package Type	θ_{JA}	θ_{JC}	Unit
E-12-4 ¹	120	86	$^\circ\text{C}/\text{W}$

¹ See JEDEC standard JESD51-2 for additional information on optimizing the thermal impedance (PCB with 3 × 3 vias).

ESD CAUTION



ESD (electrostatic discharge) sensitive device.

Charged devices and circuit boards can discharge without detection. Although this product features patented or proprietary protection circuitry, damage may occur on devices subjected to high energy ESD. Therefore, proper ESD precautions should be taken to avoid performance degradation or loss of functionality.

PIN CONFIGURATION AND FUNCTION DESCRIPTIONS

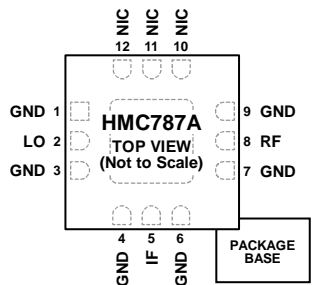

NOTES
 1. NIC = NOT INTERNALLY CONNECTED.
 2. EXPOSED PAD. EXPOSED PAD MUST BE CONNECTED TO RF/DC GROUND.

Figure 2. Pin Configuration

Table 4. Pin Function Descriptions

Pin No.	Mnemonic	Description
1, 3, 4, 6, 7, 9	GND	Ground. Connect the package bottom to RF/dc ground. See Figure 3 for the GND interface schematic.
2	LO	Local Oscillator. This pin is ac-coupled and matched to 50 Ω. See Figure 4 for the LO interface schematic.
5	IF	Intermediate Frequency. This pin is dc-coupled. For applications not requiring operation to dc, externally block this pin using a series capacitor whose value is chosen to pass the necessary IF frequency range. For operation to dc, this pin must not source or sink more than 12 mA of current or device nonfunction and possible device failure results. See for Figure 5 the IF interface schematic.
8	RF	Radio Frequency. This pin is ac-coupled and matched to 50 Ω. See Figure 6 for the RF interface schematic.
10 to 12	NIC EPAD	Not Internally Connected. Exposed Pad. Exposed pad must be connected to RF/dc ground.

INTERFACE SCHEMATICS



Figure 3. GND Interface Schematic

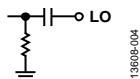

Figure 4. LO Interface Schematic



Figure 5. IF Interface Schematic

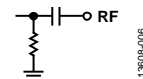

Figure 6. RF Interface Schematic

TYPICAL PERFORMANCE CHARACTERISTICS

DOWNCONVERTER PERFORMANCE

Data taken as downconverter, lower sideband (high-side LO), $T_A = 25^\circ\text{C}$, and LO drive level = 17 dBm, unless otherwise noted. Measurements taken with LO amplifier in line with lab bench LO source.

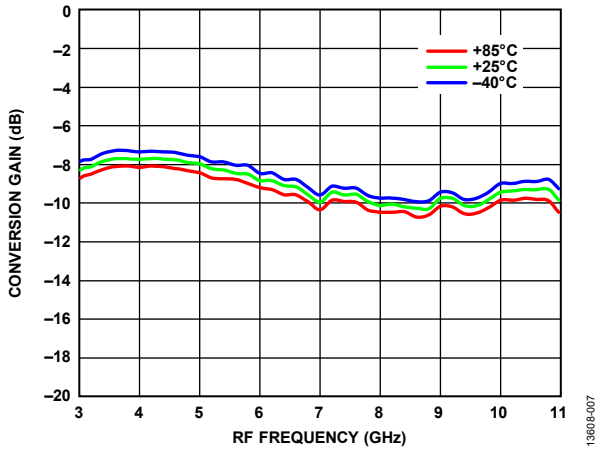

Figure 7. Conversion Gain vs. RF Frequency for Various Temperatures, $IF = 100\text{ MHz}$, LO Power = 17 dBm

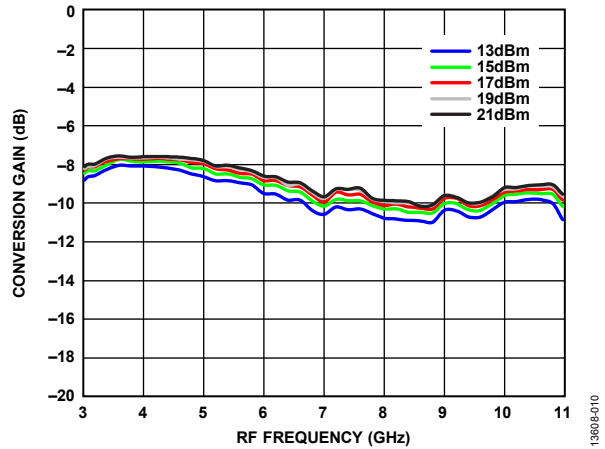

Figure 10. Conversion Gain vs. RF Frequency for Various LO Powers, $IF = 100\text{ MHz}$, Temperature = 25°C

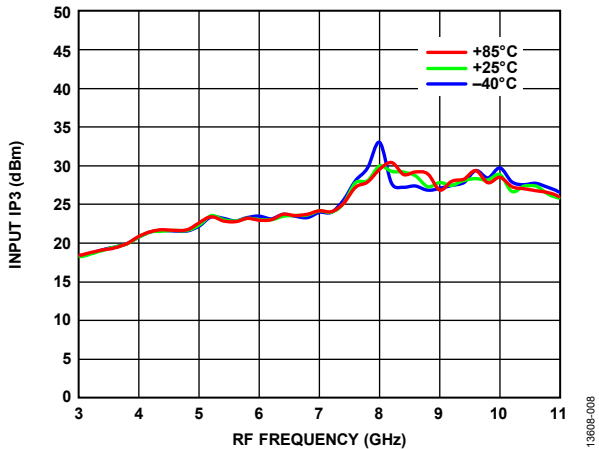

Figure 8. Input Third-Order Intercept (IP3) vs. RF Frequency for Various Temperatures, $IF = 100\text{ MHz}$, LO Power = 17 dBm

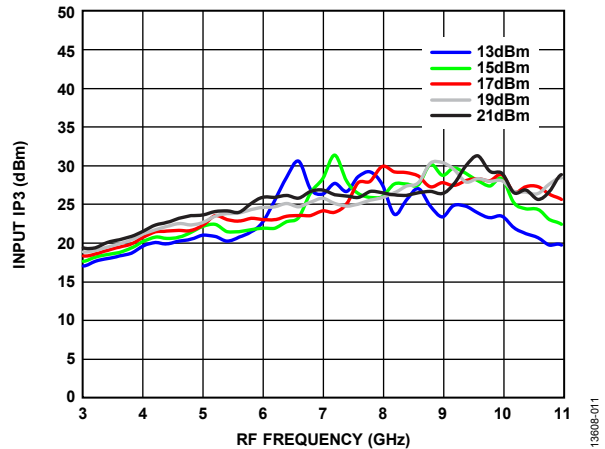

Figure 11. Input Third-Order Intercept (IP3) vs. RF Frequency for Various LO Powers, $IF = 100\text{ MHz}$, Temperature = 25°C

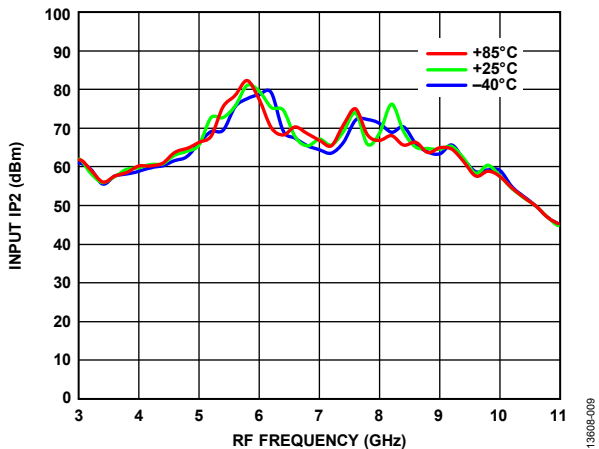

Figure 9. Input Second-Order Intercept (IP2) vs. RF Frequency for Various Temperatures, $IF = 100\text{ MHz}$, LO Power = 17 dBm

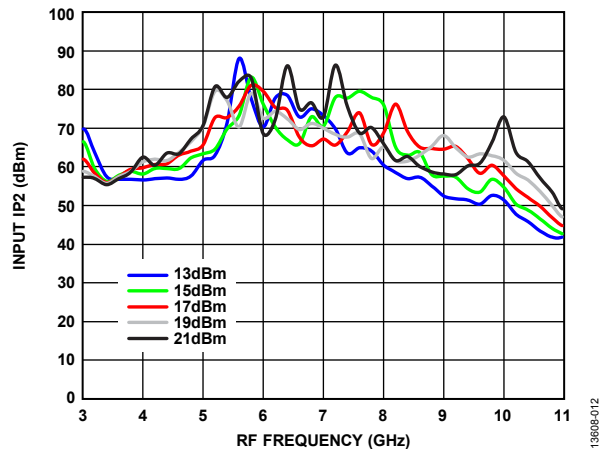

Figure 12. Input Second-Order Intercept (IP2) vs. RF Frequency for Various LO Powers, $IF = 100\text{ MHz}$, Temperature = 25°C

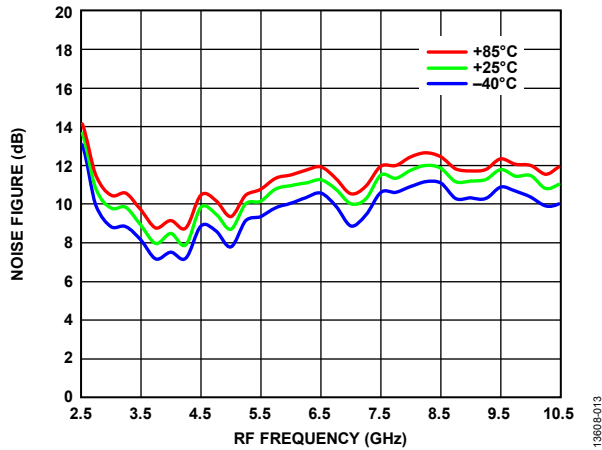

Figure 13. Single Sidband Noise Figure vs. RF Frequency for Various Temperatures, IF = 100 MHz, LO Power = 17 dBm

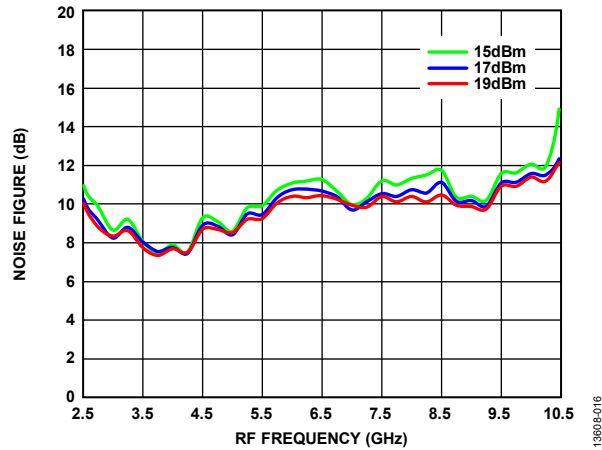

Figure 16. Single Sidband Noise Figure vs. RF Frequency for Various LO Powers, IF = 100 MHz, Temperature = 25°C

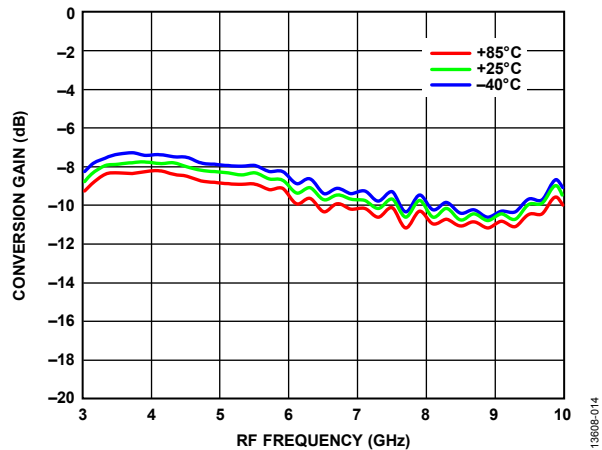

Figure 14. Conversion Gain vs. RF Frequency for Various Temperatures, IF = 1100 MHz, LO Power = 17 dBm

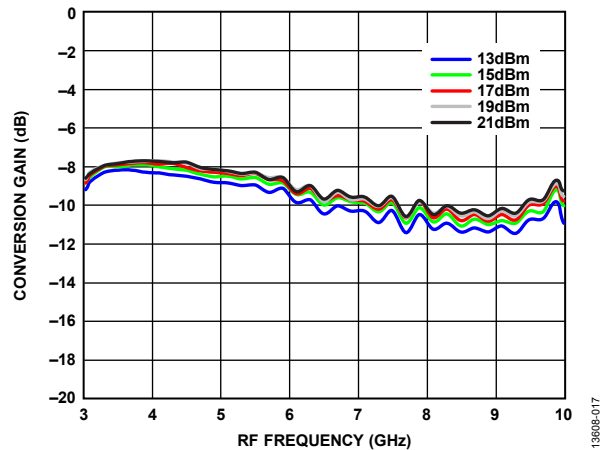

Figure 17. Conversion Gain vs. RF Frequency for Various LO Powers, IF = 1100 MHz, Temperature = 25°C

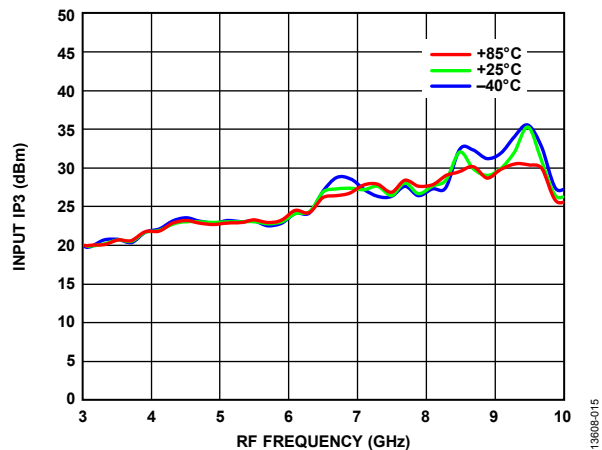

Figure 15. Input Third-Order Intercept (IP3) vs. RF Frequency for Various Temperatures, IF = 1100 MHz, LO Power = 17 dBm

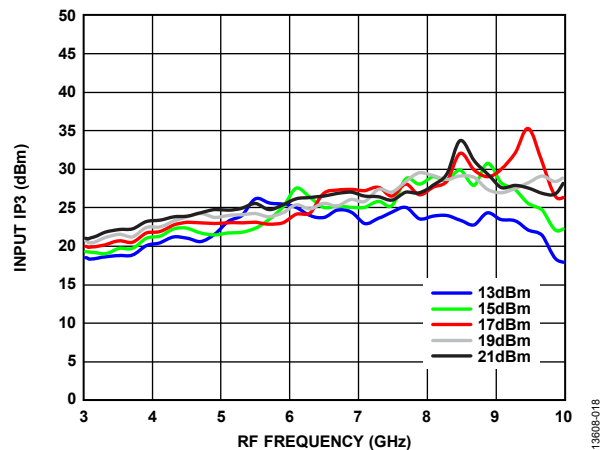

Figure 18. Input Third-Order Intercept (IP3) vs. RF Frequency for Various LO Powers, IF = 1100 MHz, Temperature = 25°C

HMC787A

Data Sheet

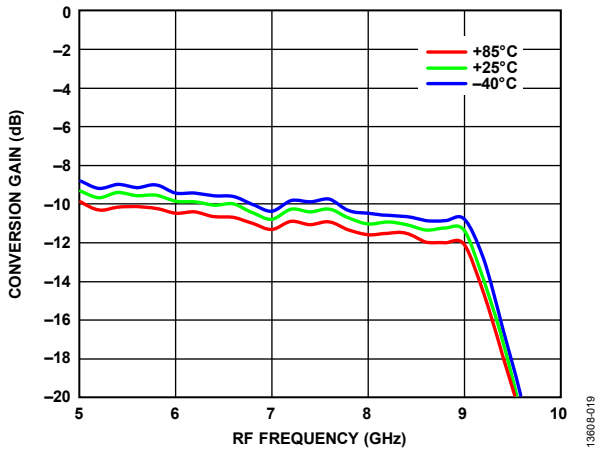

Figure 19. Conversion Gain vs. RF Frequency for Various Temperatures, IF = 3000 MHz, LO Power = 17 dBm

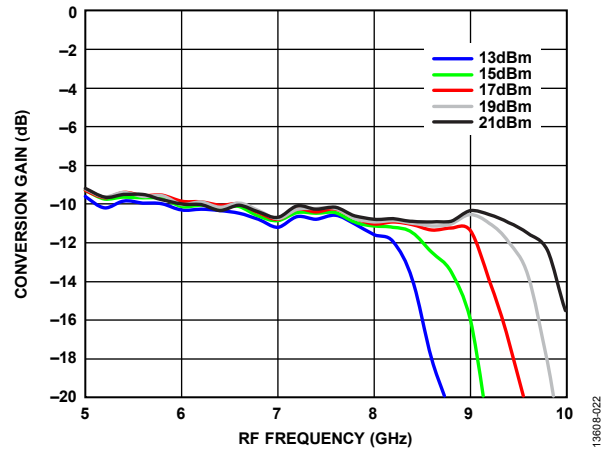

Figure 22. Conversion Gain vs. RF Frequency for Various LO Powers, IF = 3000 MHz, Temperature = 25°C

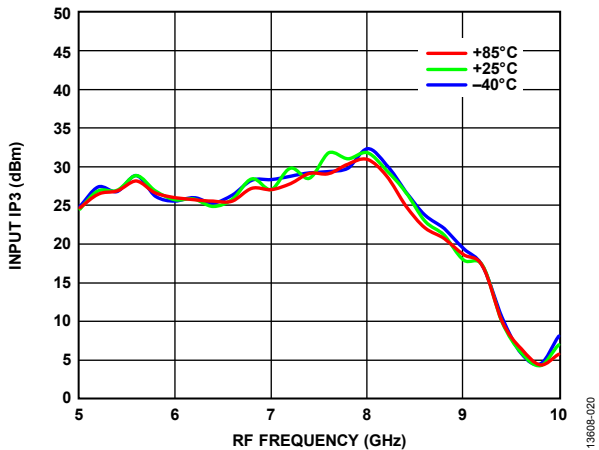

Figure 20. Input Third-Order Intercept (IP3) vs. RF Frequency for Various Temperatures, IF = 3000 MHz, LO Power = 17 dBm

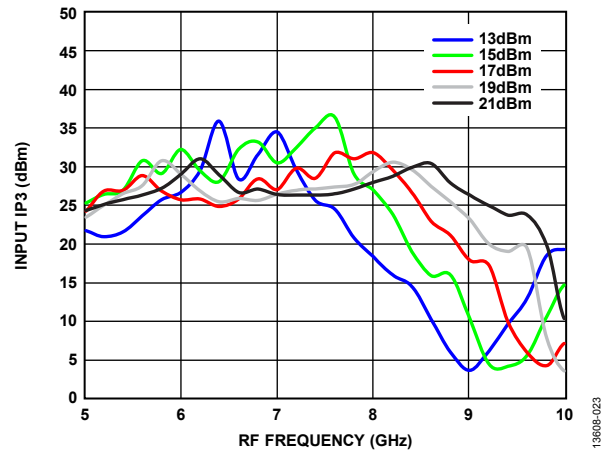

Figure 23. Input Third-Order Intercept (IP3) vs. RF Frequency for Various LO Powers, IF = 3000 MHz, Temperature = 25°C

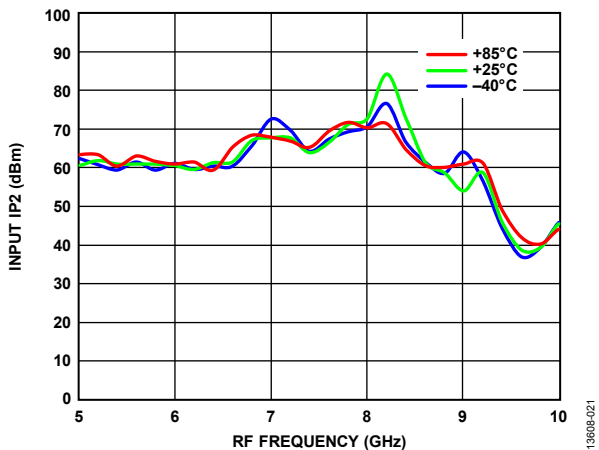

Figure 21. Input Second-Order Intercept (IP2) vs. RF Frequency at Various Temperatures, IF = 3000 MHz, LO Power = 17 dBm

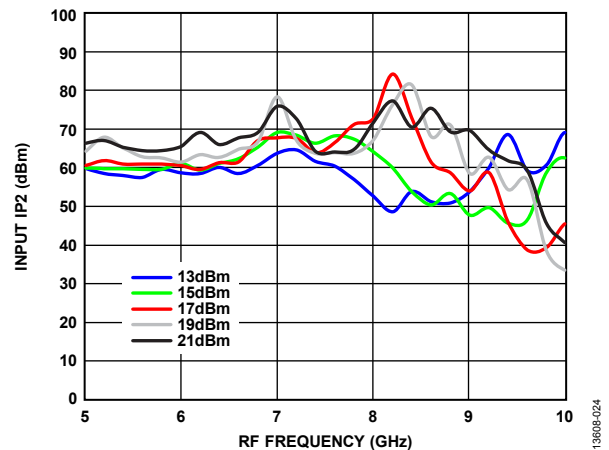

Figure 24. Input Second-Order Intercept (IP2) vs. RF Frequency for Various LO Powers, IF = 3000 MHz, Temperature = 25°C

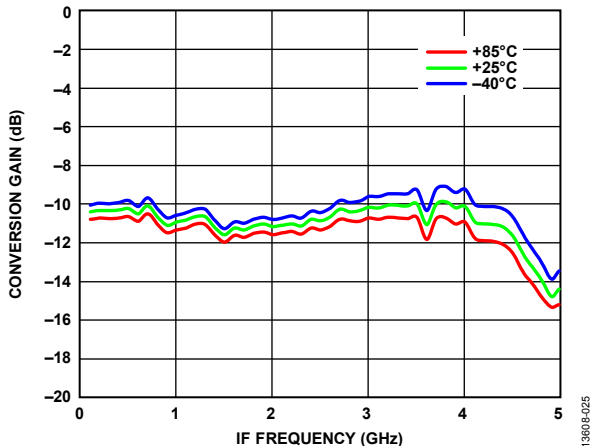

Figure 25. Conversion Gain vs. IF Frequency for Various Temperatures, LO = 9510 MHz, LO Power = 17 dBm

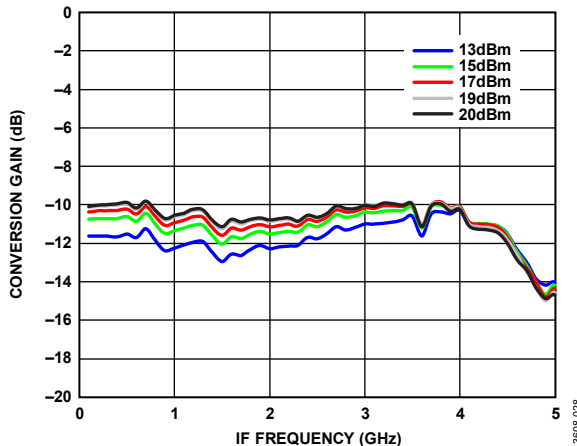

Figure 28. Conversion Gain vs. IF Frequency for Various LO Powers, LO = 9510 MHz, LO Power = 17 dBm

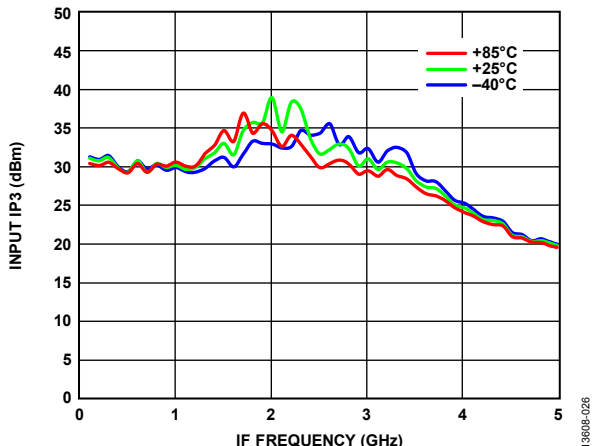

Figure 26. Input Third-Order Intercept (IP3) vs. IF Frequency for Various Temperatures, LO = 9510 MHz, LO Power = 17 dBm

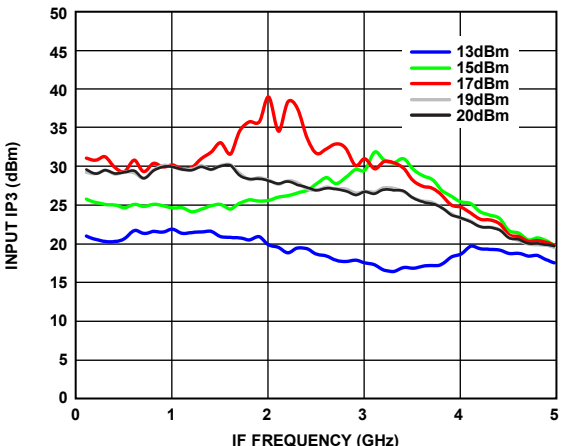

Figure 29. Input Third-Order Intercept (IP3) vs. IF Frequency for Various LO Powers, LO = 9510 MHz, LO Power = 17 dBm

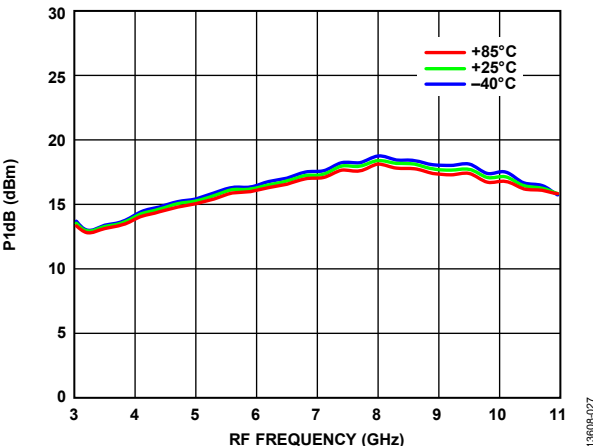

Figure 27. Input 1 dB Gain Compression (P1dB) vs. RF Frequency for Various Temperatures, IF = 100 MHz, LO = 17 dBm

HMC787A

Data Sheet

UPCONVERTER PERFORMANCE

Data taken as upconverter, lower sideband (high-side LO), $T_A = 25^\circ\text{C}$, and LO drive level = 17 dBm, unless otherwise noted. Measurements taken with LO amplifier in line with lab bench LO source.

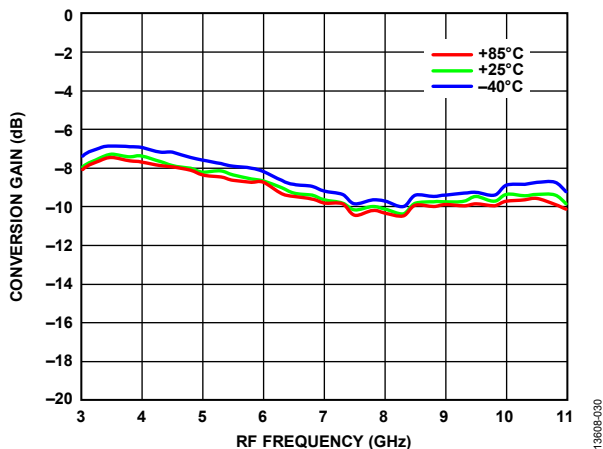

Figure 30. Conversion Gain vs. RF Frequency for Various Temperatures, $IF = 100\text{ MHz}$, LO Power = 17 dBm

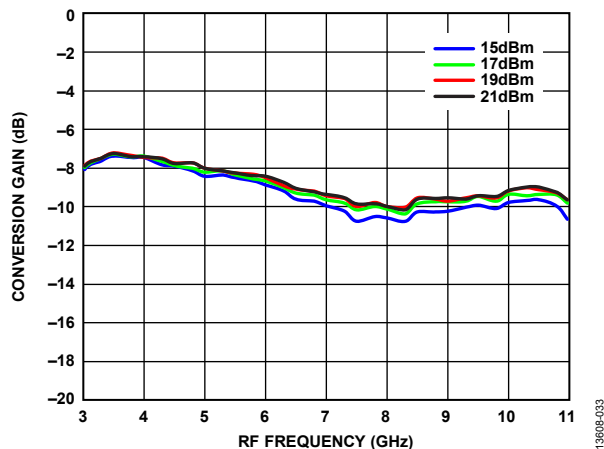

Figure 33. Conversion Gain vs. RF Frequency for Various LO Powers, $IF = 100\text{ MHz}$, Temperature = 25°C

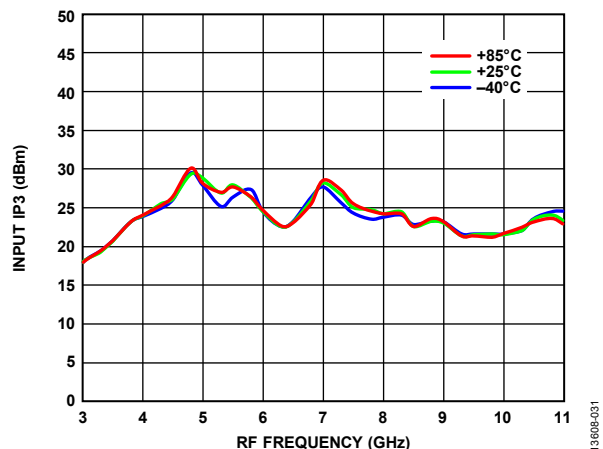

Figure 31. Input Third-Order Intercept (IP3) vs. RF Frequency for Various Temperatures, $IF = 100\text{ MHz}$, LO Power = 17 dBm

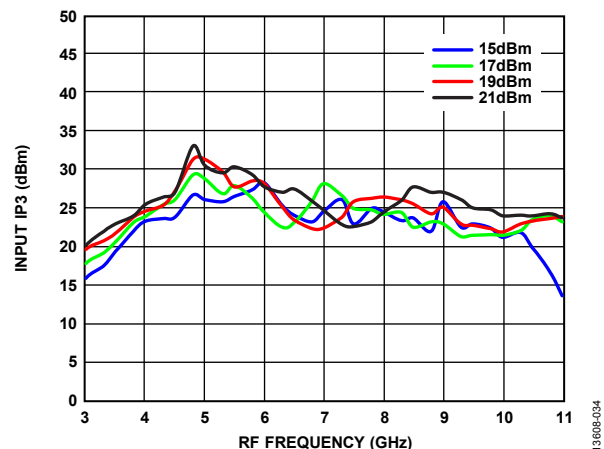

Figure 34. Input Third-Order Intercept (IP3) vs. RF Frequency for Various LO Powers, $IF = 100\text{ MHz}$, Temperature = 25°C

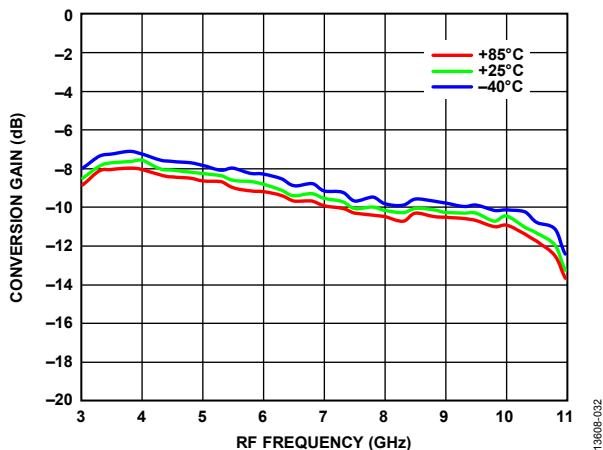

Figure 32. Conversion Gain vs. RF Frequency for Various Temperatures, $IF = 1100\text{ MHz}$, LO Power = 17 dBm

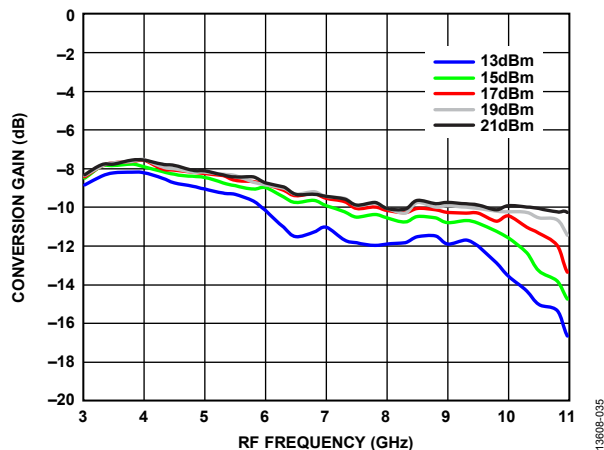

Figure 35. Conversion Gain vs. RF Frequency for Various LO Powers, $IF = 1100\text{ MHz}$, Temperature = 25°C

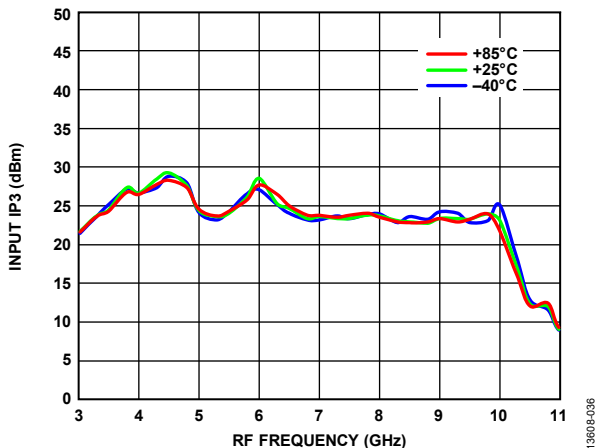

Figure 36. Input Third-Order Intercept (IP3) vs. RF Frequency for Various Temperatures at IF = 1100 MHz, LO Power = 17 dBm

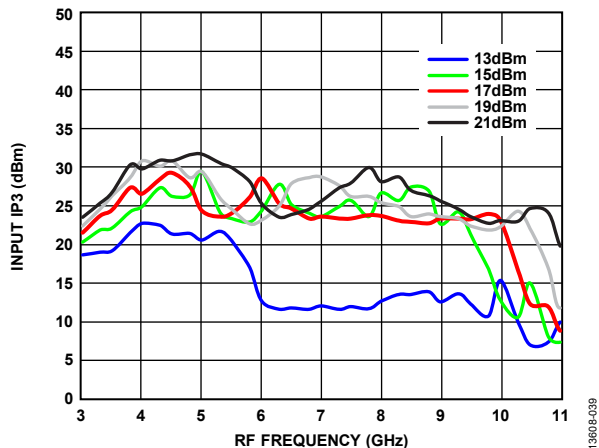

Figure 39. Input Third-Order Intercept (IP3) vs. RF Frequency for Various LO Powers at IF = 1100 MHz, Temperature = 25°C

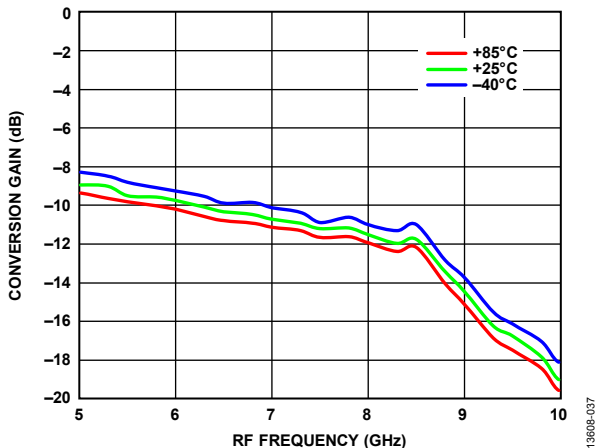

Figure 37. Conversion Gain vs. RF Frequency for Various Temperatures, IF = 3000 MHz, LO Power = 17 dBm

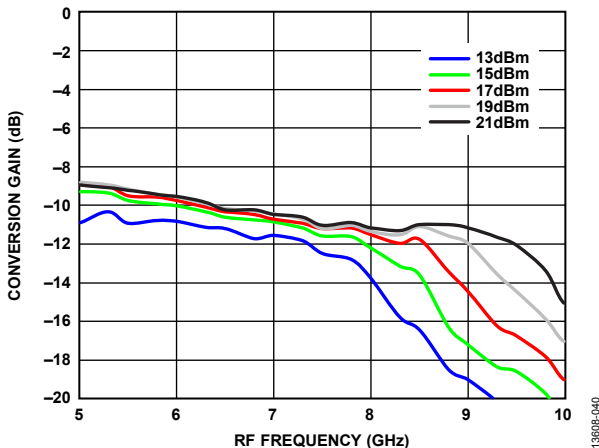

Figure 40. Conversion Gain vs. RF Frequency for Various LO Powers, IF = 3000 MHz, Temperature = 25°C

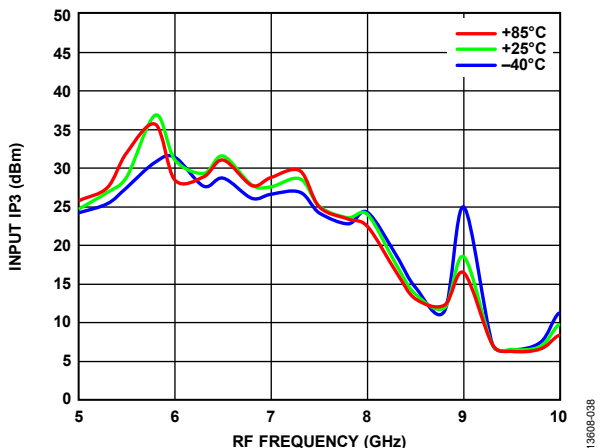

Figure 38. Input Third-Order Intercept (IP3) vs. RF Frequency for Various Temperatures at IF = 3000 MHz, LO Power = 17 dBm

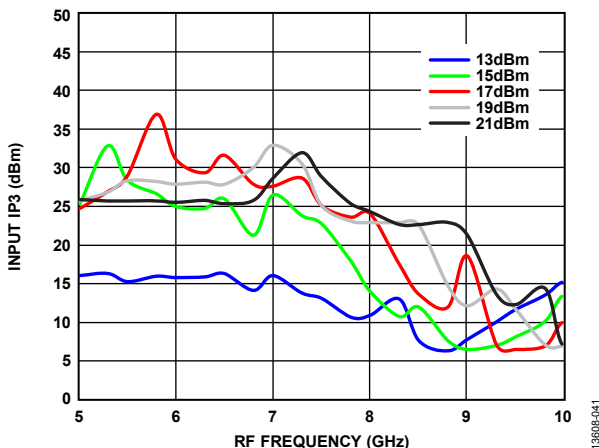

Figure 41. Input Third-Order Intercept (IP3) vs. RF Frequency for Various LO Powers at IF = 3000 MHz, Temperature = 25°C

ISOLATION AND RETURN LOSS PERFORMANCE

Data taken as downconverter, lower sideband (high-side LO), IF = 100 MHz, $T_A = 25^\circ\text{C}$, and LO drive level = 17 dBm, unless otherwise noted. Measurements taken with LO amplifier in line with lab bench LO source.

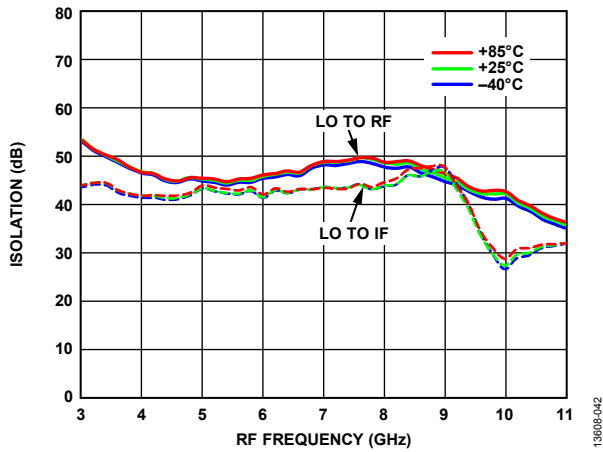

Figure 42. LO to RF and LO to IF Isolation vs. RF Frequency for Various Temperatures, LO Power = 17 dBm

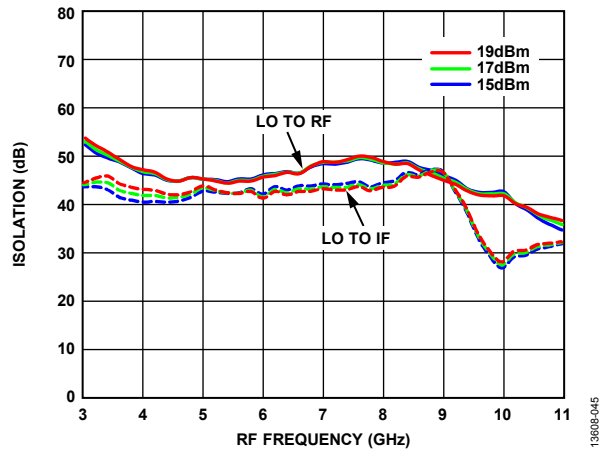

Figure 45. LO to RF and LO to IF Isolation vs. RF Frequency for Various LO Powers, Temperature = 25°C

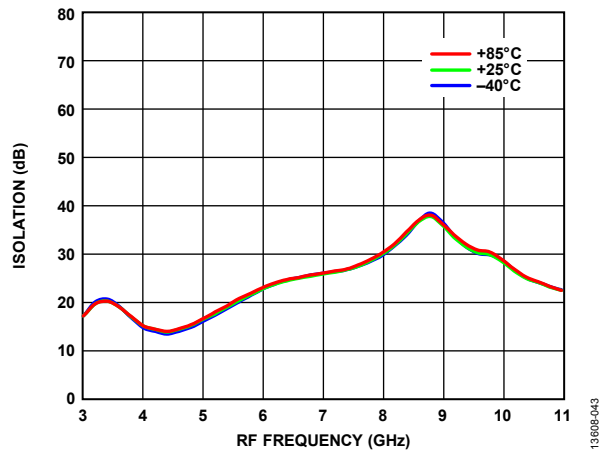

Figure 43. RF to IF Isolation vs. RF Frequency for Various Temperatures, LO Frequency = 7000 MHz, LO Power = 17 dBm

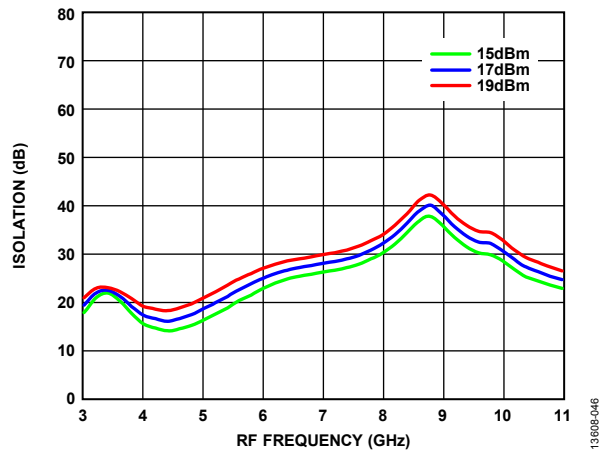

Figure 46. RF to IF Isolation vs. RF Frequency for Various LO Powers, Temperature = 25°C, LO Frequency = 7000 MHz

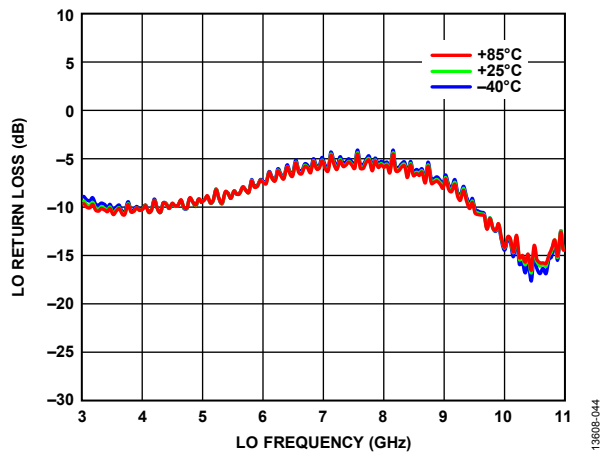

Figure 44. LO Return Loss vs. LO Frequency at Various Temperatures, LO Power = 17 dBm

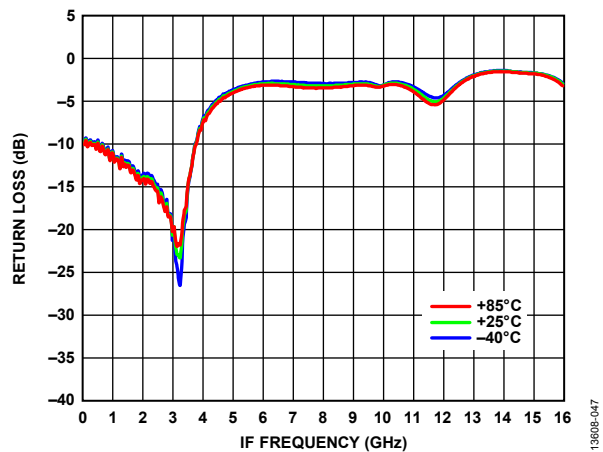

Figure 47. IF Return Loss vs. IF Frequency at Various Temperatures, LO Power = 17 dBm, LO Frequency = 6 GHz

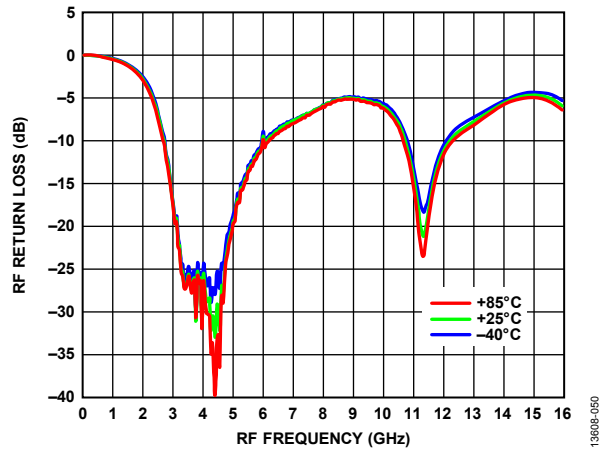

Figure 48. RF Return Loss vs. RF Frequency at Various Temperatures,
LO Power = 17 dBm, LO Frequency = 6 GHz

HMC787A

Data Sheet

SPURIOUS AND HARMONICS PERFORMANCE

Mixer spurious products are measured in dBc from the IF output power level, unless otherwise noted. Spur values are $(M \times RF) - (N \times LO)$.

LO Harmonics

LO = 17 dBm, and all values in dBc below input LO level measured at RF port.

Table 5. Harmonics of LO

LO Frequency (GHz)	N _{LO} Spur at RF Port			
	1	2	3	4
3	55	53	58	59
6	46	45	64	76
10	41	57	61	61

M × N Spurious Outputs, IF = 100 MHz

RF = 3.1 GHz, LO = 3 GHz, RF power = -5 dBm, and LO power = 17 dBm.

		N × LO				
		0	1	2	3	4
M × RF	0	Not applicable	14	38	32	54
	1	12.3	0	25	27	60
	2	90.1	93	98	94	90
	3	91.1	90	92	98	94
	4	89.1	88	91	94	98

RF = 6.1 GHz, LO = 6 GHz, RF power = -5 dBm, and LO power = 17 dBm.

		N × LO				
		0	1	2	3	4
M × RF	0	Not applicable	12	26	42	42
	1	16.3	0	36	35	50
	2	89.1	91	97	90	88
	3	86.2	88	88	95	87
	4	83.1	87	89	90	96

RF = 10.1 GHz, LO = 10 GHz, RF power = -5 dBm, and LO power = 17 dBm.

		N × LO				
		0	1	2	3	4
M × RF	0	Not applicable	4	39	36	43
	1	19.9	0	87	83	79
	2	84.3	84	97	87	83
	3	78.4	82	87	97	87
	4	72.4	78	83	89	95

M × N Spurious Outputs, IF = 3000 MHz

RF = 3.1 GHz, LO = 6.1 GHz, RF power = -5 dBm, and LO power = 17 dBm.

		N × LO				
		0	1	2	3	4
M × RF	0	Not applicable	13	28	44	44
	1	13.6	0	47	45	64
	2	90.7	99	89	89	86
	3	91	93	94	87	87
	4	90.2	89	99	92	90

RF = 6.1 GHz, LO = 3.1 GHz, RF power = -5 dBm, and LO power = 17 dBm.

		N × LO				
		0	1	2	3	4
M × RF	0	Not applicable	13	39	28	50
	1	16	0	24	18	90
	2	89	88	89	92	97
	3	86	86	89	87	89
	4	82	86	85	87	89

RF = 10.1 GHz, LO = 7.1 GHz, RF power = -5 dBm, and LO power = 17 dBm.

		N × LO				
		0	1	2	3	4
M × RF	0	Not applicable	11	28	41	54
	1	17.7	0	30	35	52
	2	82.9	86	84	94	86
	3	75	81	86	87	92
	4	68	76	79	83	87

THEORY OF OPERATION

The [HMC787A](#) is a general-purpose, double balanced mixer in a 12-terminal, RoHS compliant, ceramic leadless chip carrier (LCC) package that can be used as an upconverter or down-converter from 3 GHz to 10 GHz. This mixer is fabricated in a gallium arsenide (GaAs), metal semiconductor field effect transistor (MESFET) process and requires no external components or matching circuitry. The [HMC787A](#) provides excellent local

oscillator (LO) to radio frequency (RF) and LO to intermediate frequency (IF) isolation due to optimized balun structures and operates with a LO drive level of 17 dBm. The ceramic LCC package eliminates the need for wire bonding and is compatible with high volume, surface-mount manufacturing techniques.

APPLICATIONS INFORMATION

TYPICAL APPLICATION CIRCUIT

Figure 49 shows the typical application circuit for the HMC787A. The LO and RF pins are internally ac-coupled. When IF operation is not required until dc, it is recommended to use an ac-coupled capacitor at the IF port. When IF operation to dc is required, do not exceed the IF source and sink currents specified in the Absolute Maximum Ratings section.

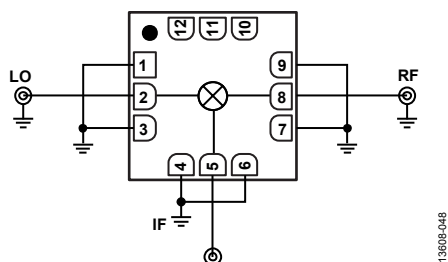

Figure 49. Typical Applications Circuit

EVALUATION PCB INFORMATION

The circuit board used in the application must use RF circuit design techniques. Signal lines must have 50 Ω impedance, and the package ground leads and exposed pad must be connected directly to the ground plane similarly to that shown in Figure 50. Use a sufficient number of via holes to connect the top and bottom ground planes. The evaluation circuit board shown in Figure 50 is available from Analog Devices, Inc., upon request.

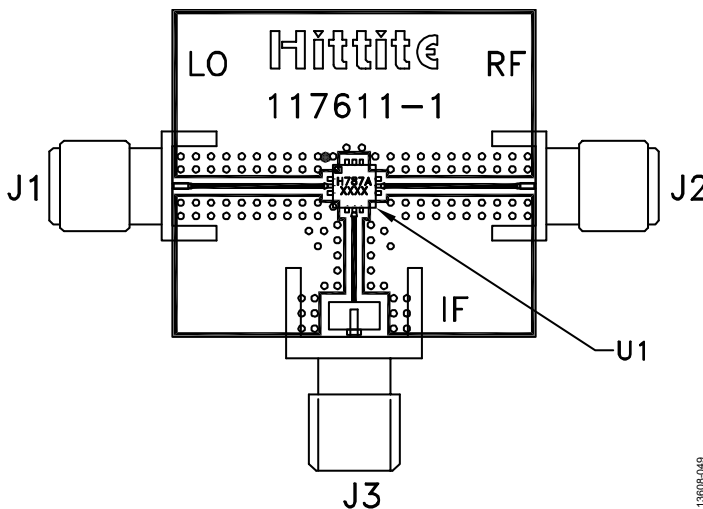

Figure 50. Evaluation PCB Top Layer

Table 6. Bill of Materials for the EV1HMC787ALC3B Evaluation PCB

Quantity	Reference Designator	Part Number	Description
1		117611-1	PCB, evaluation board
2	J1 to J2	104935	2.92 mm connectors, SRI
1	J3	105192	SMA connector, Johnson
1	U1	HMC787ALCB	Device under test (DUT)

OUTLINE DIMENSIONS

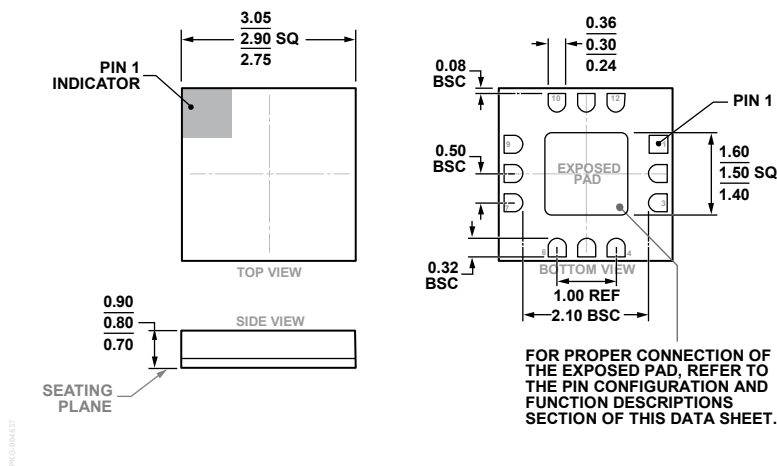

Figure 51. 12-Terminal Ceramic Leadless Chip Carrier [LCC] (E-12-4)
Dimensions shown in millimeters

ORDERING GUIDE

Model ¹	Temperature Range	Package Body Material	Lead Finish	MSL Rating ²	Package Description	Package Option	Package Marking ³
HMC787ALC3B	-40°C to +85°C	Alumina Ceramic	Gold over Nickel	MSL3	12-Terminal Ceramic Leadless Chip Carrier [LCC]	E-12-4	787A XXXX
HMC787ALC3BTR	-40°C to +85°C	Alumina Ceramic	Gold over Nickel	MSL3	12-Terminal Ceramic Leadless Chip Carrier [LCC]	E-12-4	787A XXXX
HMC787ALC3BTR-R5	-40°C to +85°C	Alumina Ceramic	Gold over Nickel	MSL3	12-Terminal Ceramic Leadless Chip Carrier [LCC]	E-12-4	787A XXXX
EV1HMC787ALC3B					Evaluation PCB Assembly		

¹ The HMC787ALC3B, the HMC787ALC3BTR, and the HMC787ALC3BTR-R5 are RoHS Compliant Parts.
² See the Absolute Maximum Ratings section.
³ The HMC787ALC3B, the HMC787ALC3BTR, and the HMC787ALC3BTR-R5 have a four digit lot number.

OUR CERTIFICATE

DiGi provide top-quality products and perfect service for customer worldwide through standardization, technological innovation and continuous improvement. DiGi through third-party certification, we stricly control the quality of products and services. Welcome your RFQ to

Email: Info@DiGi-Electronics.com



Tel: +00 852-30501935

RFQ Email: Info@DiGi-Electronics.com

DiGi is a global authorized distributor of electronic components.