

# LT5581IDDB#TRPBF Datasheet

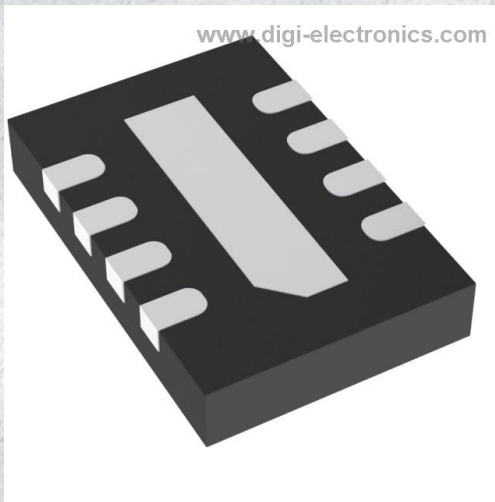

<https://www.DiGi-Electronics.com>

DiGi Electronics Part Number	LT5581IDDB#TRPBF-DG
Manufacturer	<a href="#">Analog Devices Inc.</a>
Manufacturer Product Number	LT5581IDDB#TRPBF
Description	IC RF DETECT 10MHZ-6GHZ 8DFN
Detailed Description	RF Detector IC CATV 10MHz ~ 6GHz -34dBm ~ 6dBm ±1dB 8-WDFN Exposed Pad

This model LT5581IDDB#TRPBF is available at DiGi Electronics.

DiGi Electronics offers a global database of semiconductor and electronic component datasheets.

We welcome your inquiries regarding pricing, lead time, or other product-related questions.

 [Request a Quote](#)

 [Datasheet Search](#)



Tel: +00 852-30501935

RFQ Email: [Info@DiGi-Electronics.com](mailto:Info@DiGi-Electronics.com)

DiGi is a global authorized distributor of electronic components.

## Purchase and inquiry

Manufacturer Product Number:

LT5581IDDB#TRPBF

Series:

-

Frequency:

10MHz ~ 6GHz

Input Range:

-34dBm ~ 6dBm

Voltage - Supply:

2.7V ~ 5.25V

Mounting Type:

Surface Mount

Supplier Device Package:

8-DFN (3x2)

Manufacturer:

Analog Devices Inc.

Product Status:

Active

RF Type:

CATV

Accuracy:

±1dB

Current - Supply:

1.4 mA

Package / Case:

8-WFDFN Exposed Pad

Base Product Number:

LT5581

## Environmental & Export classification

RoHS Status:

ROHS3 Compliant

REACH Status:

REACH Unaffected

HTSUS:

8542.39.0001

Moisture Sensitivity Level (MSL):

1 (Unlimited)

ECCN:

EAR99

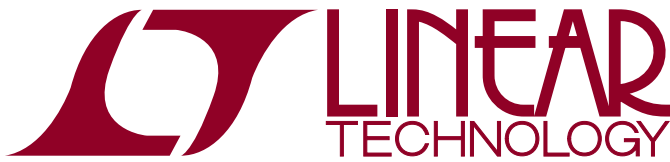

LT5581

## 6GHz RMS Power Detector with 40dB Dynamic Range

### FEATURES

- Frequency Range: 10MHz to 6GHz
- Accurate Power Measurement of High Crest Factor (Up to 12dB) Waveforms
- 40dB Log Linear Dynamic Range
- Exceptional Accuracy Over Temperature
- Fast Response Time: 1 $\mu$ s Rise, 8 $\mu$ s Fall
- Low Power: 1.4mA at 3.3V
- Log-Linear DC Output vs Input RF Power in dBm
- Small 3mm  $\times$  2mm 8-Pin DFN Package
- Single-Ended RF Input

### APPLICATIONS

- GSM/EDGE, CMDA, CDMA2000, W-CDMA, LTE, WiMAX RF Power Control
- Pico-Cells, Femto-Cells RF Power Control
- Wireless Repeaters
- CATV/DVB Transmitters
- MIMO Wireless Access Points
- Portable RMS Power Measurement Instrumentation

### DESCRIPTION

The **LT<sup>®</sup>5581** is a 10MHz to 6GHz, low power monolithic precision RMS power detector. The RMS detector uses a proprietary technique to accurately measure the RF power from  $-34$ dBm to  $+6$ dBm (at 2.14GHz) of modulated signals with a crest factor as high as 12dB. It outputs a DC voltage in linear scale proportional to an RF input signal power in dBm. The LT5581 is suitable for precision power measurement and control for a wide variety of RF standards, including GSM/EDGE, CDMA, CDMA2000, W-CDMA, TD-SCDMA, UMTS, LTE and WiMAX, etc. The final DC output is connected in series with an on-chip 300 $\Omega$  resistor, which enables further filtering of the output modulation ripple with just a single off-chip capacitor.

LT, LT, LTC, LTM, Linear Technology and the Linear logo are registered trademarks of Linear Technology Corporation. All other trademarks are the property of their respective owners. Protected by U.S. Patents, including 7342431.

### TYPICAL APPLICATION

10MHz to 6GHz Infrastructure Power Amplifier Level Control

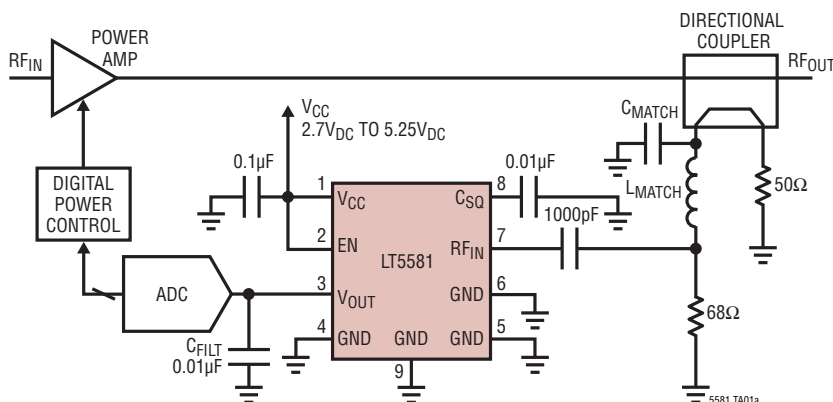

Linearity Error vs RF Input Power, 2140MHz Modulated Waveforms

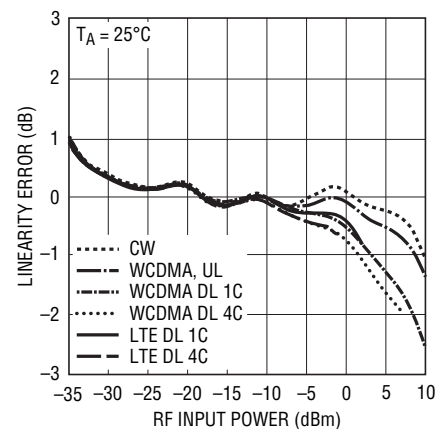

5581 TA01b

# LT5581

## ABSOLUTE MAXIMUM RATINGS

(Note 1)

Supply Voltage .....	5.5V
Maximum Input Signal Power—Average .....	15dBm
Maximum Input Signal Power—Peak (Note 7) ....	25dBm
DC Voltage at RF <sub>IN</sub> .....	−0.3V to 2V
V <sub>OUT</sub> Voltage .....	−0.3V to V <sub>CC</sub> + 0.3V
Maximum Junction Temperature, T <sub>JMAX</sub> .....	150°C
Operating Temperature Range .....	−40°C to 85°C
Storage Temperature Range .....	−65°C to 150°C

CAUTION: This part is sensitive to electrostatic discharge. It is very important that proper ESD precautions be observed when handling the LT5581.

## PIN CONFIGURATION

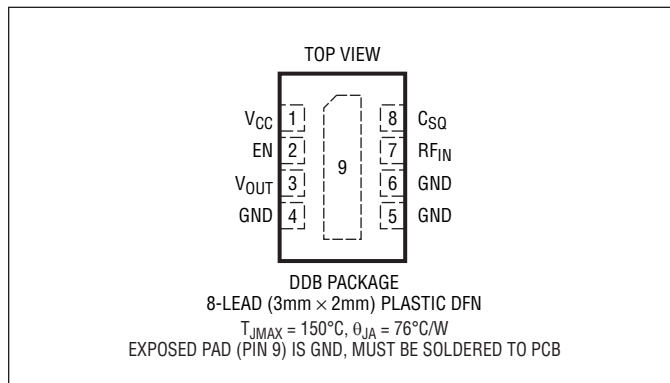

## ORDER INFORMATION

LEAD FREE FINISH	TAPE AND REEL	PART MARKING	PACKAGE DESCRIPTION	TEMPERATURE RANGE
LT5581IDDB#PBF	LT5581IDDB#TRPBF	LDKM	8-Lead (3mm × 2mm) Plastic DFN	−40°C to 85°C

Consult LTC Marketing for parts specified with wider operating temperature ranges.

Consult LTC Marketing for information on non-standard lead based finish parts.

For more information on lead free part marking, go to: <http://www.linear.com/leadfree/>

For more information on tape and reel specifications, go to: <http://www.linear.com/tapeandreeel/>

**ELECTRICAL CHARACTERISTICS** The ● denotes the specifications which apply over the full operating temperature range, otherwise specifications are at T<sub>A</sub> = 25°C, V<sub>CC</sub> = 3.3V, EN = 3.3V, unless otherwise noted (Note 2). Test circuit is shown in Figure 1.

PARAMETER	CONDITIONS	MIN	TYP	MAX	UNITS
<b>AC Input</b>					
Input Frequency Range (Note 4)			10-6000		MHz
Input Impedance			205  1.6		Ω  pF
<b>f<sub>RF</sub> = 450MHz</b>					
RF Input Power Range	Externally Matched to 50Ω Source		−34 to 6		dBm
Linear Dynamic Range, CW (Note 3)	±1dB Linearity Error		40		dB
Linear Dynamic Range, CDMA (Note 3)	±1dB Linearity Error; CDMA 4-Carrier		40		dB
Output Slope			31		mV/dB
Logarithmic Intercept (Note 5)			−42		dBm
Output Variation vs Temperature	Normalized to Output at 25°C, −40°C < T <sub>A</sub> < 85°C; P <sub>IN</sub> = −34 to +6dBm		±1		dB
Output Variation vs Temperature	Normalized to Output at 25°C, −40°C < T <sub>A</sub> < 85°C; P <sub>IN</sub> = −27 to −10dBm		±0.5		dB
Deviation from CW Response; P <sub>IN</sub> = −34dBm to 0dBm	TETRA π/4 DQPSK CDMA 4-Carrier 64-Channel Fwd 1.23Mcps		±0.1 ±0.5		dB dB

5581fb

## ELECTRICAL CHARACTERISTICS

The ● denotes the specifications which apply over the full operating temperature range, otherwise specifications are at  $T_A = 25^\circ\text{C}$ ,  $V_{CC} = 3.3\text{V}$ ,  $V_{EN} = 3.3\text{V}$ , unless otherwise noted (Note 2). Test circuit is shown in Figure 1.

PARAMETER	CONDITIONS	MIN	TYP	MAX	UNITS
2nd Order Harmonic Distortion	At RF Input; CW Input; $P_{IN} = 0\text{dBm}$		-57		dBc
3rd Order Harmonic Distortion	At RF Input; CW Input; $P_{IN} = 0\text{dBm}$		-52		dBc
<b><math>f_{RF} = 880\text{MHz}</math></b>					
RF Input Power Range	Externally Matched to $50\Omega$ Source		-34 to 6		dBm
Linear Dynamic Range, CW (Note 3)	$\pm 1\text{dB}$ Linearity Error		40		dB
Linear Dynamic Range, EDGE (Note 3)	$\pm 1\text{dB}$ Linearity Error; EDGE $3\pi/8$ -Shifted 8PSK		40		dB
Output Slope			31		mV/dB
Logarithmic Intercept (Note 5)			-42		dBm
Output Variation vs Temperature	Normalized to Output at $25^\circ\text{C}$ , $-40^\circ\text{C} < T_A < 85^\circ\text{C}$ ; $P_{IN} = -34$ to $+6\text{dBm}$		$\pm 1$		dB
Output Variation vs Temperature	Normalized to Output at $25^\circ\text{C}$ , $-40^\circ\text{C} < T_A < 85^\circ\text{C}$ ; $P_{IN} = -27$ to $-10\text{dBm}$		$\pm 0.5$		dB
Deviation from CW Response, $P_{in} = -34$ to $+6\text{dBm}$	EDGE $3\pi/8$ Shifted 8PSK		$\pm 0.1$		dB
<b><math>f_{RF} = 2140\text{MHz}</math></b>					
RF Input Power Range	Externally Matched to $50\Omega$ Source		-34 to 6		dBm
Linear Dynamic Range, CW (Note 3)	$\pm 1\text{dB}$ Linearity Error		43		dB
Linear Dynamic Range, WCDMA (Note 3)	$\pm 1\text{dB}$ Linearity Error; 4-Carrier WCDMA		37		dB
Output Slope			31		mV/dB
Logarithmic Intercept (Note 5)			-42		dBm
Output Variation vs Temperature	Normalized to Output at $25^\circ\text{C}$ , $-40^\circ\text{C} < T_A < 85^\circ\text{C}$ ; $P_{IN} = -34$ to $6\text{dBm}$		$\pm 1$		dB
Output Variation vs Temperature	Normalized to Output at $25^\circ\text{C}$ , $-40^\circ\text{C} < T_A < 85^\circ\text{C}$ ; $P_{IN} = -27$ to $-10\text{dBm}$		$\pm 0.5$		dB
Maximum Deviation from CW Response $P_{IN} = -34$ to $-4\text{dBm}$	WCDMA 1-Carrier Uplink WCDMA 64-Channel 4-Carrier Downlink		$\pm 0.1$ $\pm 0.5$		dB dB
<b><math>f_{RF} = 2600\text{MHz}</math></b>					
RF Input Power Range	Externally Matched to $50\Omega$ Source		-34 to 6		dBm
Linear Dynamic Range, CW (Note 3)	$\pm 1\text{dB}$ Linearity Error		40		dB
Output Slope			31		mV/dB
Logarithmic Intercept (Note 5)			-42		dBm
Output Variation vs Temperature	Normalized to Output at $25^\circ\text{C}$ , $-40^\circ\text{C} < T_A < 85^\circ\text{C}$ ; $P_{IN} = -34$ to $+6\text{dBm}$		$\pm 1$		dB
Output Variation vs Temperature	Normalized to Output at $25^\circ\text{C}$ , $-40^\circ\text{C} < T_A < 85^\circ\text{C}$ ; $P_{IN} = -27$ to $-10\text{dBm}$		$\pm 0.5$		dB
Maximum Deviation from CW Response $P_{IN} = -34$ to $2\text{dBm}$	WiMAX OFDMA Preamble WiMAX OFDM Burst		$\pm 0.1$ $\pm 0.5$		dB dB
<b><math>f_{RF} = 3500\text{MHz}</math></b>					
RF Input Power Range	Externally Matched to $50\Omega$ Source		-30 to 6		dBm
Linear Dynamic Range, CW (Note 3)	$\pm 1\text{dB}$ Linearity Error		36		dB
Output Slope			31		mV/dB
Logarithmic Intercept (Note 5)			-41		dBm
Output Variation vs Temperature	Normalized to Output at $25^\circ\text{C}$ , $-40^\circ\text{C} < T_A < 85^\circ\text{C}$ ; $P_{IN} = -30$ to $+6\text{dBm}$		$\pm 1$		dB

## LT5581

**ELECTRICAL CHARACTERISTICS** The ● denotes the specifications which apply over the full operating temperature range, otherwise specifications are at  $T_A = 25^\circ\text{C}$ ,  $V_{CC} = 3.3\text{V}$ ,  $EN = 3.3\text{V}$ , unless otherwise noted (Note 2). Test circuit is shown in Figure 1.

PARAMETER	CONDITIONS	MIN	TYP	MAX	UNITS	
Output Variation vs Temperature	Normalized to Output at $25^\circ\text{C}$ , $-40^\circ\text{C} < T_A < 85^\circ\text{C}$ ; $P_{IN} = -27$ to $-10\text{dBm}$		$\pm 0.5$		dB	
Deviation from CW Response $P_{IN} = -34$ to $-4\text{dBm}$	WiMAX OFDMA Preamble WiMAX OFDM Burst		$\pm 0.1$ $\pm 0.5$		dB dB	
<b><math>f_{RF} = 5800\text{MHz}</math></b>						
RF Input Power Range	Externally Matched to $50\Omega$ Source		$-25$ to $6$		dBm	
Linear Dynamic Range, CW (Note 3)	$\pm 1\text{dB}$ Linearity Error		$31$		dB	
Output Slope			$31$		mV/dB	
Logarithmic Intercept (Note 5)			$-33$		dBm	
Output Variation vs Temperature	Normalized to Output at $25^\circ\text{C}$ , $-40^\circ\text{C} < T_A < 85^\circ\text{C}$ ; $P_{IN} = -25$ to $+6\text{dBm}$		$\pm 1$		dB	
Output Variation vs Temperature	Normalized to Output at $25^\circ\text{C}$ , $-40^\circ\text{C} < T_A < 85^\circ\text{C}$ ; $P_{IN} = -20$ to $+6\text{dBm}$		$\pm 0.5$		dB	
Deviation from CW Response	WiMAX OFDM Burst; $P_{IN} = -25$ to $6\text{dBm}$		$\pm 0.2$		dB	
<b>Output</b>						
Output DC Voltage	No Signal Applied to RF Input		$180$		mV	
Output Impedance	Internal Series Resistor Allows for Off-Chip Filter Cap		$300$		$\Omega$	
Output Current Sourcing/Sinking			$5/5$		mA	
Rise Time	$0.2\text{V}$ to $1.6\text{V}$ , $10\%$ to $90\%$ , $f_{RF} = 2140\text{MHz}$		$1$		$\mu\text{s}$	
Fall Time	$1.6\text{V}$ to $0.2\text{V}$ , $10\%$ to $90\%$ , $f_{RF} = 2140\text{MHz}$		$8$		$\mu\text{s}$	
Power Supply Rejection Ratio (Note 6)	For Over Operating Input Power Range		$49$		dB	
Integrated Output Voltage Noise	$1\text{kHz}$ to $6.5\text{kHz}$ Integration BW, $P_{IN} = 0\text{dBm}$ CW		$150$		$\mu\text{V}_{\text{RMS}}$	
<b>Enable (EN) Low = Off, High = On</b>						
EN Input High Voltage (On)		●	$2$		V	
EN Input Low Voltage (Off)		●		$0.3$	V	
Enable Pin Input Current	$EN = 3.3\text{V}$		$20$		$\mu\text{A}$	
Turn-On Time; CW RF input	$V_{OUT}$ Within $10\%$ of Final Value; $P_{IN} = 0\text{dBm}$		$1$		$\mu\text{s}$	
Settling Time; RF Pulse	$V_{OUT}$ Within $10\%$ of Final Value; $P_{IN} = 0\text{dBm}$		$1$		$\mu\text{s}$	
<b>Power Supply</b>						
Supply Voltage		●	$2.7$	$3.3$	$5.25$	V
Supply Current	No RF Input Signal			$1.4$		mA
Shutdown Current	$EN = 0.3\text{V}$ , $V_{CC} = 3.3\text{V}$			$0.2$	$6$	$\mu\text{A}$

**Note 1:** Stresses beyond those listed under Absolute Maximum Ratings may cause permanent damage to the device. Exposure to any Absolute Maximum Rating condition for extended periods may affect device reliability and lifetime.

**Note 2:** The LT5581 is guaranteed functional over the operating temperature range from  $-40^\circ\text{C}$  to  $85^\circ\text{C}$ .

**Note 3:** The linearity error is calculated by the difference between the incremental slope of the output and the average output slope from  $-20\text{dBm}$  to  $0\text{dBm}$ . The dynamic range is defined as the range over which the linearity error is within  $\pm 1\text{dB}$ .

**Note 4:** An external capacitor at the  $C_{SQ}$  pin should be used for input frequencies below  $250\text{MHz}$ . Lower frequency operation results in excessive RF ripple in the output voltage.

**Note 5:** Logarithmic intercept is an extrapolated input power level from the best fitted log-linear straight line, where the output voltage is  $0\text{V}$ .

**Note 6:** PSRR is determined as the dB value of the change in  $V_{OUT}$  voltage over the change in  $V_{CC}$  supply voltage.

**Note 7:** Not production tested. Guaranteed by design and correlation to production tested parameters.

# TYPICAL PERFORMANCE CHARACTERISTICS

Performance characteristics taken at  $V_{CC} = 3.3V$ ,  $EN = 3.3V$  and  $T_A = 25^\circ C$ , unless otherwise noted. (Test circuit shown in Figure 1)

**Output Voltage vs Frequency**

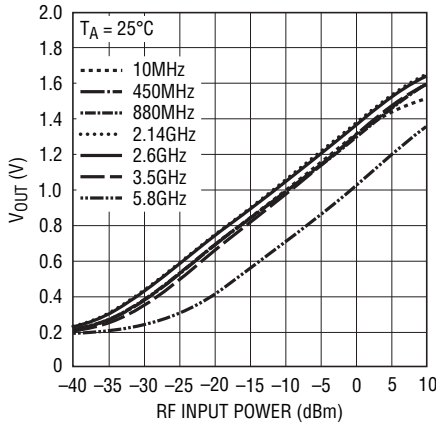

5581 G01

**Output Voltage vs Frequency**

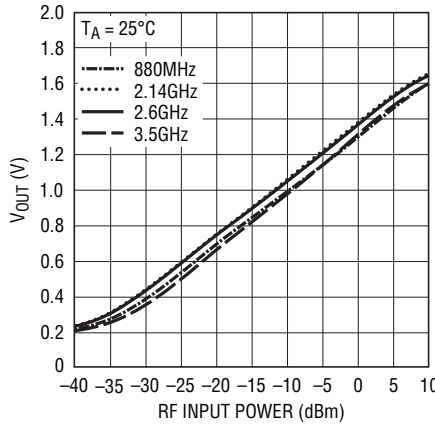

5581 G02

**Linearity Error vs Frequency**

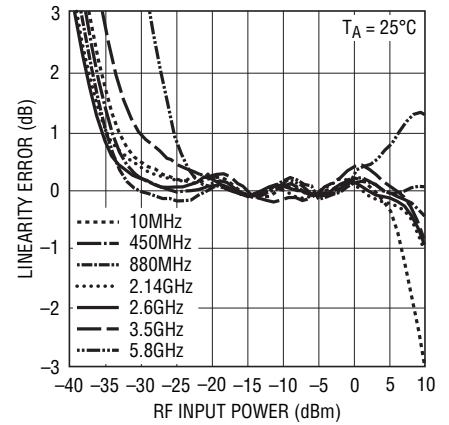

5581 G03

**Output Voltage and Linearity Error at 450MHz**

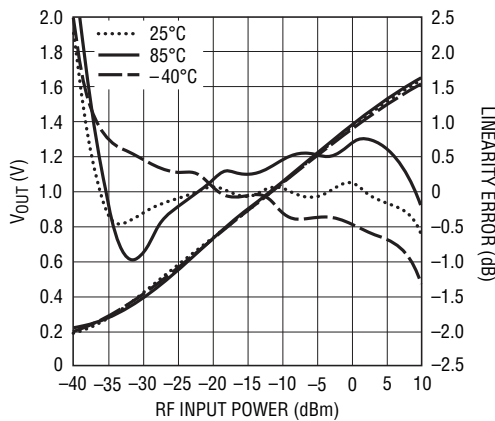

5581 G04

**Linearity Error Temperature Variation from 25°C at 450MHz**

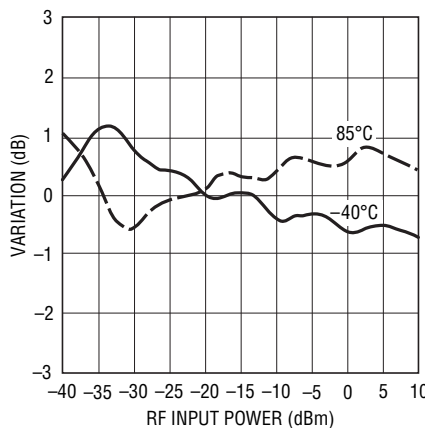

5581 G05

**Linearity Error vs RF Input Power, 450MHz Modulated Waveforms**

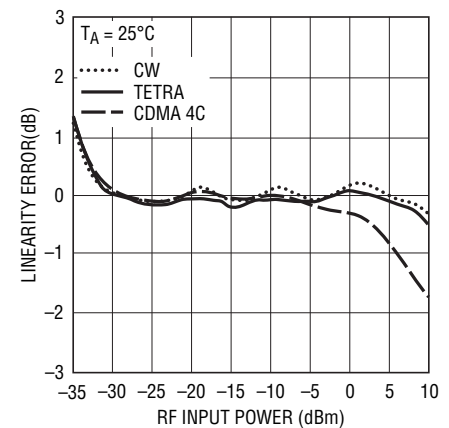

5581 G06

**Output Voltage and Linearity Error at 880MHz**

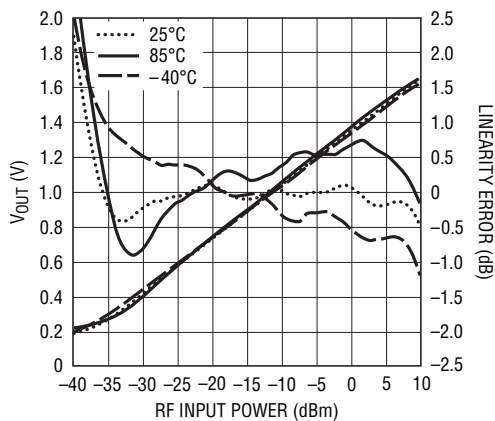

5581 G07

**Linearity Error Temperature Variation from 25°C at 880MHz**

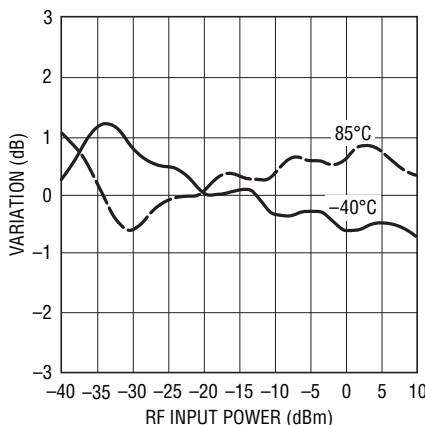

5581 G08

**Linearity Error vs RF Input Power, 880MHz Modulated Waveforms**

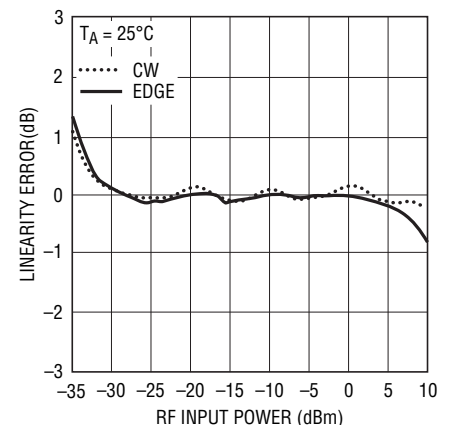

5581 G09

5581fb

# LT5581

## TYPICAL PERFORMANCE CHARACTERISTICS

**Output Voltage and Linearity Error at 2140MHz**

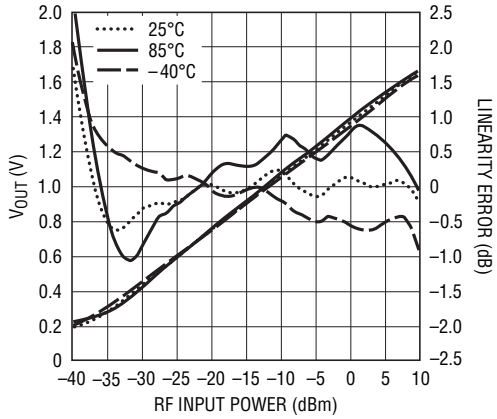

5581 G10

**Linearity Error Temperature Variation from 25°C at 2140MHz**

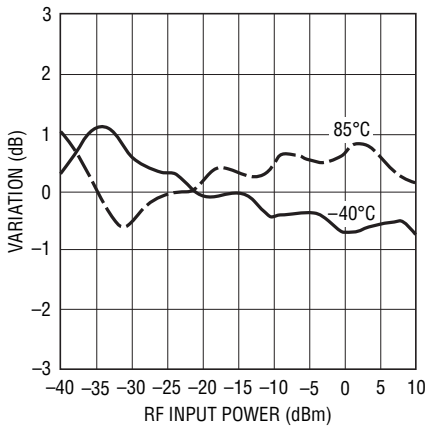

5581 G11

**Linearity Error vs RF Input Power, 2140MHz Modulated Waveforms**

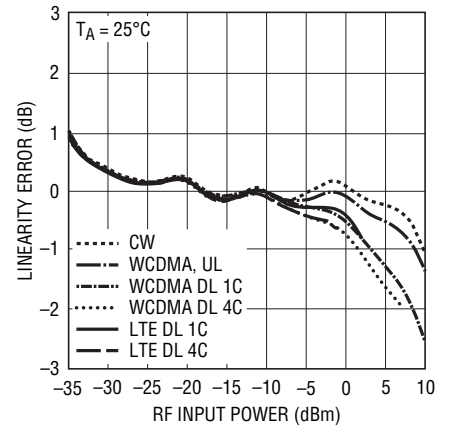

5581 G12

**Output Voltage and Linearity Error at 2600MHz**

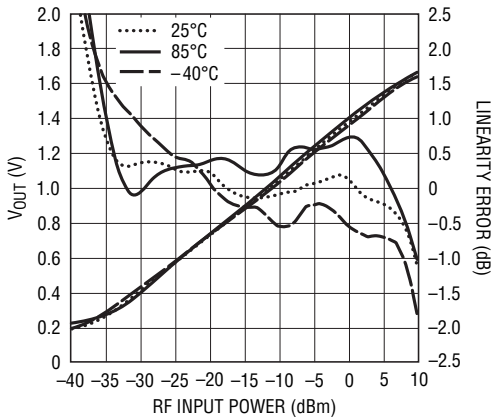

5581 G13

**Linearity Error Temperature Variation from 25°C at 2600MHz**

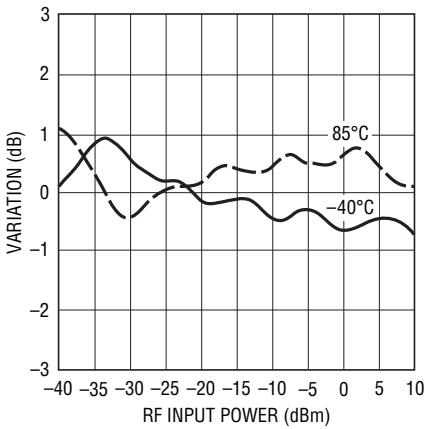

5581 G14

**Linearity Error vs RF Input Power, 2.6GHz Modulated Waveforms**

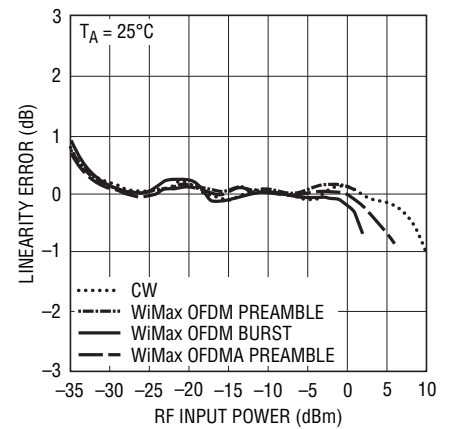

5581 G15

**Output Voltage and Linearity Error at 3500MHz**

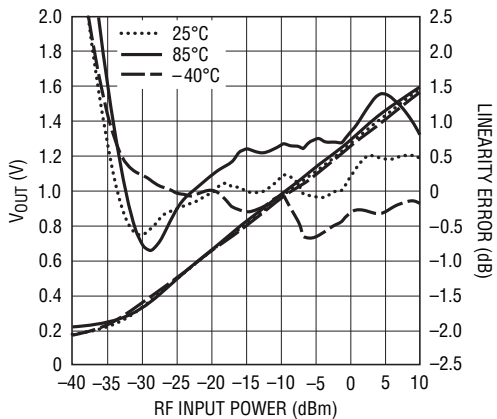

5581 G16

**Linearity Error Temperature Variation from 25°C at 3500MHz**

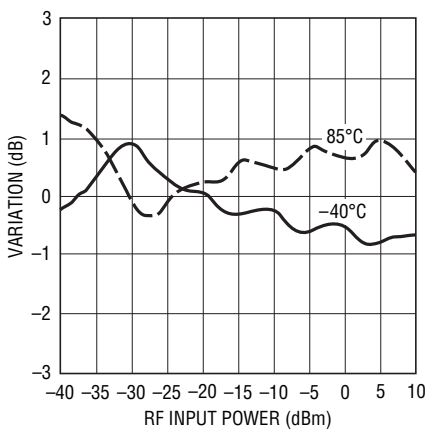

5581 G17

**Linearity Error vs RF Input Power, 3.5GHz Modulated Waveforms**

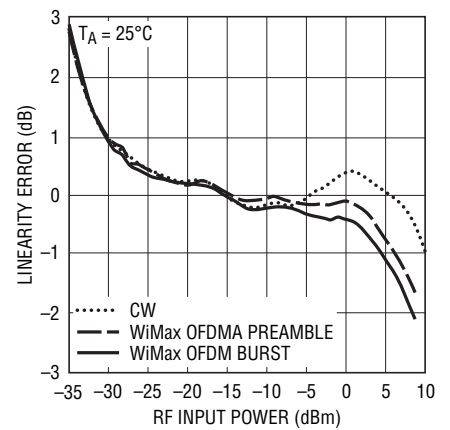

5581 G18

5581fb

# TYPICAL PERFORMANCE CHARACTERISTICS

**Output Voltage and Linearity Error at 5800MHz**

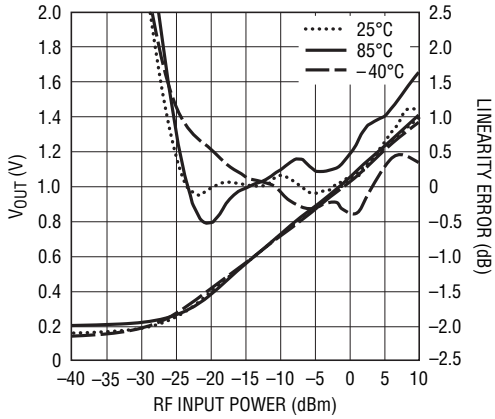

5581 G19

**Linearity Error Temperature Variation from 25°C at 5800MHz**

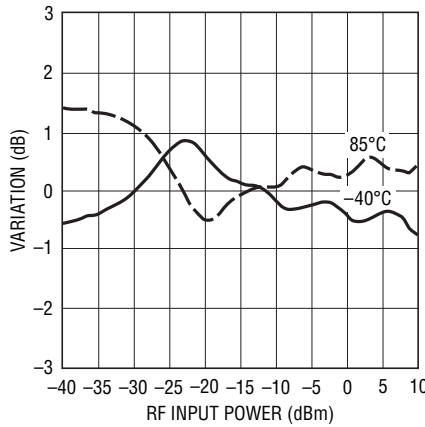

5581 G20

**Linearity Error vs RF Input Power, 5.8GHz Modulated Waveforms**

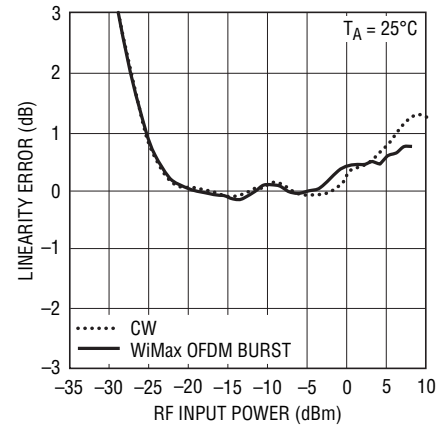

5581 G21

**Slope vs Frequency**

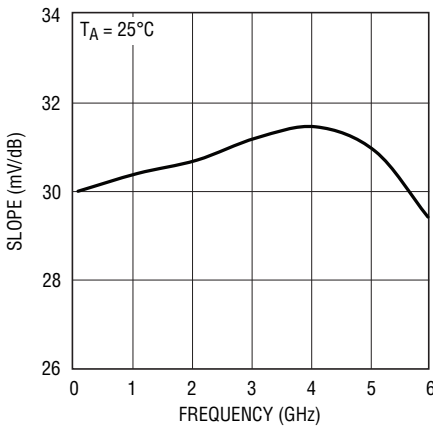

5581 G22

**Slope Distribution vs Temperature**

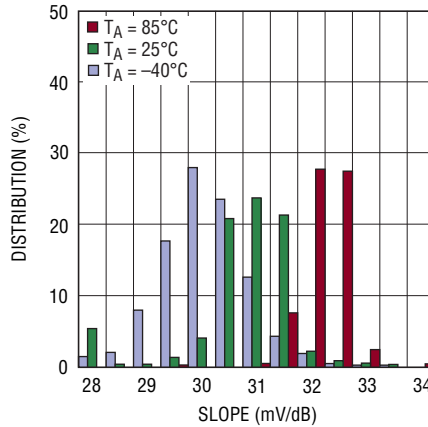

5581 G23

**Supply Current vs Supply Voltage**

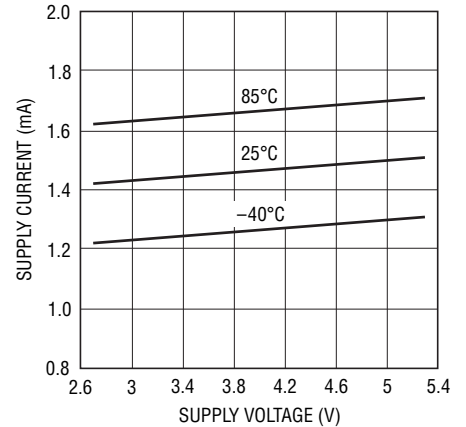

5581 G24

**Logarithmic Intercept vs Frequency**

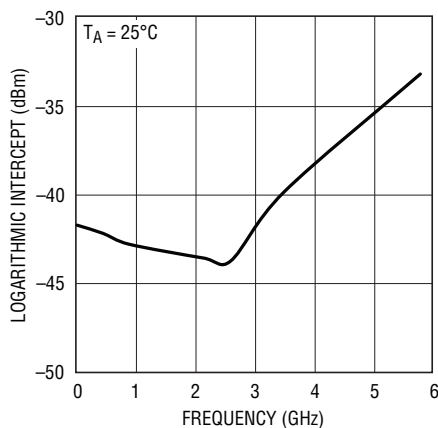

5581 G25

**Logarithmic Intercept Distribution vs Temperature**

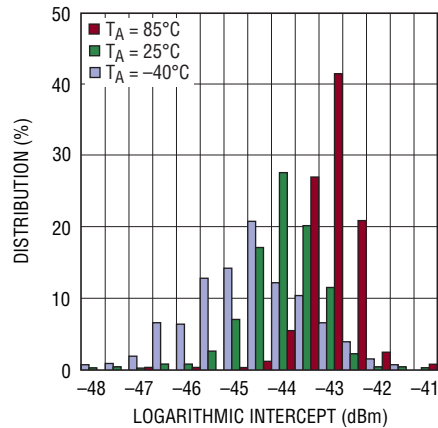

5581 G26

# LT5581

## TYPICAL PERFORMANCE CHARACTERISTICS

**Supply Current vs RF Input Power**

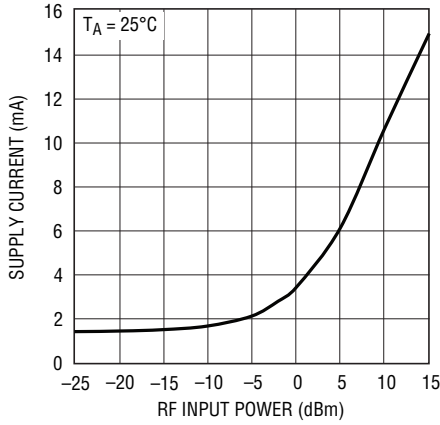

**Output Voltage and Linearity Error vs  $V_{CC}$  at 2140MHz**

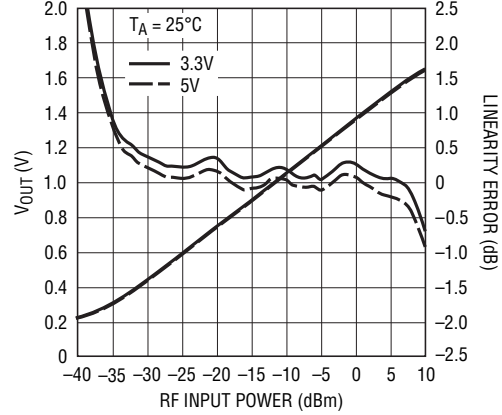

**Return Loss vs Frequency Reference in Figure 1 Test Circuit**

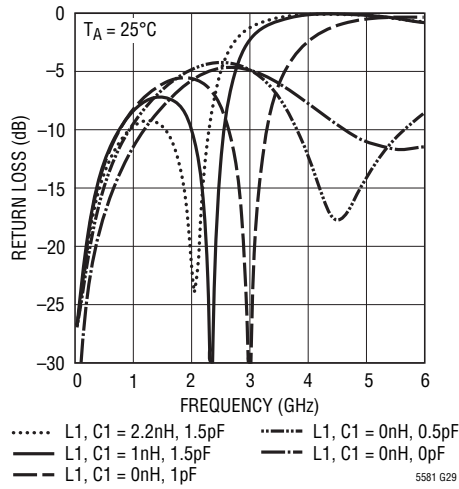

**Output Transient Response with RF and EN Pulse**

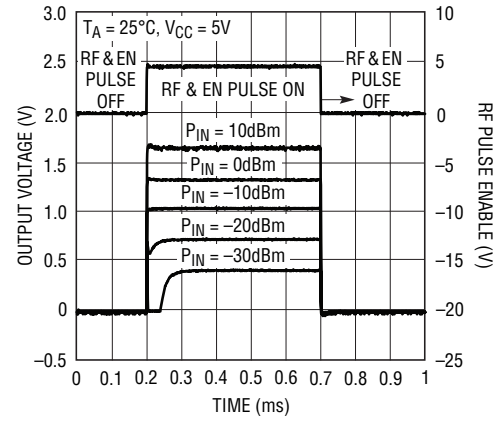

**Output Transient Response**

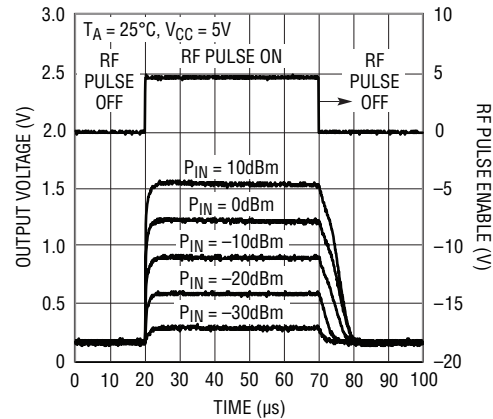

**Output Transient Response with CW RF and EN Pulse**

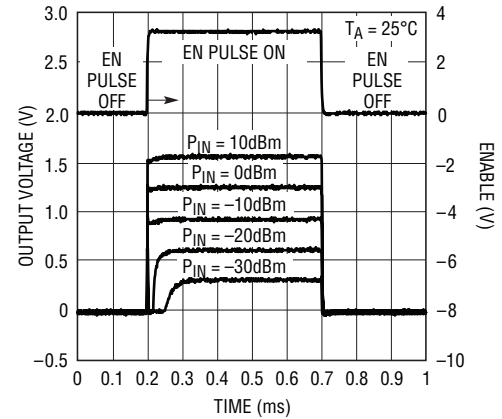

## PIN FUNCTIONS

**V<sub>CC</sub> (Pin 1):** Power Supply, 2.7V to 5.25V. V<sub>CC</sub> should be bypassed with a 0.1 $\mu$ F ceramic capacitor.

**EN (Pin 2):** Chip Enable. A logic low or no-connect on the enable pin shuts down the part. A logic high enables the part. An internal 500k pull-down resistor ensures the part is off when the enable driver is in a three-state condition.

**V<sub>OUT</sub> (Pin 3):** Detector Output.

**GND (Pins 4, 5, 6):** Ground.

**RF<sub>IN</sub> (Pin 7):** RF Input. Should be DC-blocked with coupling capacitor; 1000pF recommended. This pin has an internal 200 $\Omega$  termination.

**C<sub>SQ</sub> (Pin 8):** Optional Low Frequency Range Extension Capacitor. This pin is for frequencies below 250MHz. Use 0.01 $\mu$ F from pin to ground for 10MHz operation.

**Exposed Pad (Pin 9):** Ground. The Exposed Pad must be soldered to the PCB. For high frequency operation, the backside ground connection should have a low inductance connection to the PCB ground, using many through-hole vias. See the layout information in the Applications Information section.

## BLOCK DIAGRAM

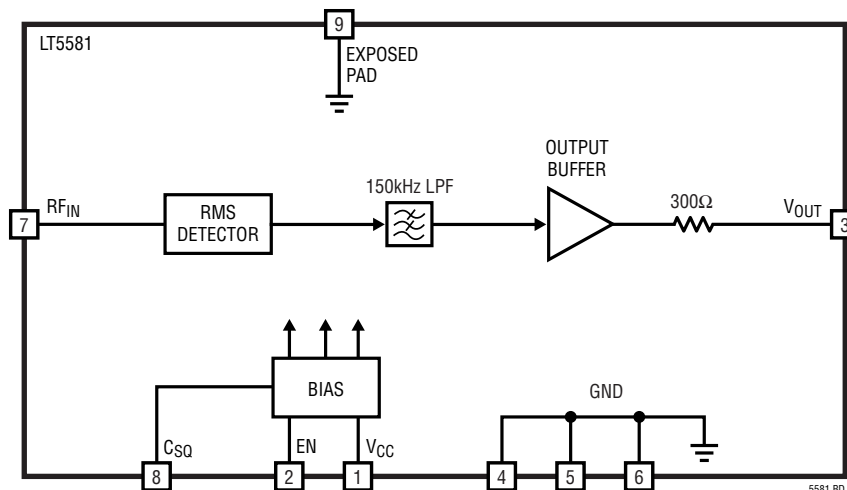

# LT5581

## TEST CIRCUIT

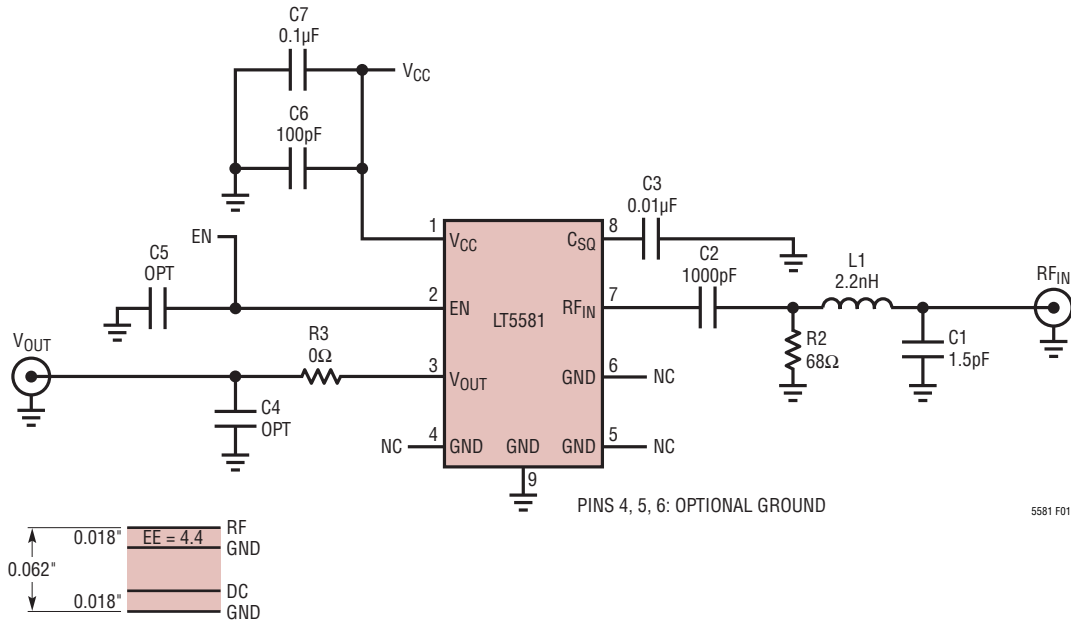

REF DES	VALUE	SIZE	PART NUMBER
C6	100pF	0603	AVX 06033A101KAT2A
C7	0.1µF	0603	AVX 06033C104KAT2A
C3	0.01µF	0603	AVX 06033C103KAT2A
C2	1000pF	0603	AVX 06033C102KAT2A
R2	68Ω	0603	

FREQUENCY RANGE	RF <sub>IN</sub> MATCH	
	L1	C1
1GHz to 2.2GHz	2.2nH	1.5pF
2GHz to 2.6GHz	1.2nH	1.5pF
2.6GHz to 3.4GHz	0	1pF
3.8GHz to 5.5GHz	0	0.5pF
4.6GHz to 6GHz	0	0

Figure 1. Evaluation Circuit Schematic

## APPLICATIONS INFORMATION

### OPERATION

To achieve an accurate average power measurement of the high crest factor modulated RF signals, the LT5581 combines a proprietary high speed power measurement subsystem with an internal 150kHz low pass averaging filter and an output voltage buffer in a completely integrated solution with minimal off-chip components. The resulting output voltage is directly proportional to the average RF input power in dBm. Figure 1 shows the evaluation circuit schematic, and Figures 2 and 3 show the associated board artwork. For best high frequency performance, it is important to place many ground vias directly under the package.

### RF Input Matching

The input resistance is about 205Ω. Input capacitance is 1.6pF. The impedance vs frequency of the RF input is detailed in Table 1.

Table 1. RF Input Impedance

FREQUENCY (MHz)	INPUT IMPEDANCE (Ω)	S11	
		MAG	ANGLE (°)
10	203.6-j5.5	0.606	-0.8
50	199.5-j22.4	0.603	-3.4
100	191.7-j40.3	0.601	-6.4
200	171.1-j68.5	0.601	-12.3
400	121.8-j95.4	0.608	-24
500	100.2-j97.5	0.613	-29.8
800	56.8-j86.5	0.631	-46.5
900	48-j81.2	0.638	-51.8
1000	41.1-j76	0.645	-56.8
1500	22.2-j55	0.679	-79.5
2000	14.6-j41.4	0.710	-97.9
2100	13.6-j39.2	0.716	-101.2
2500	10.8-j32.1	0.737	-112.9
3000	8.6-j25	0.759	-125.7
3500	7.3-j19.4	0.774	-136.9
4000	6.6-j14.5	0.783	-147.1
5000	8.8-j9.6	0.709	-157.6
6000	6.4-j0	0.774	-179.9

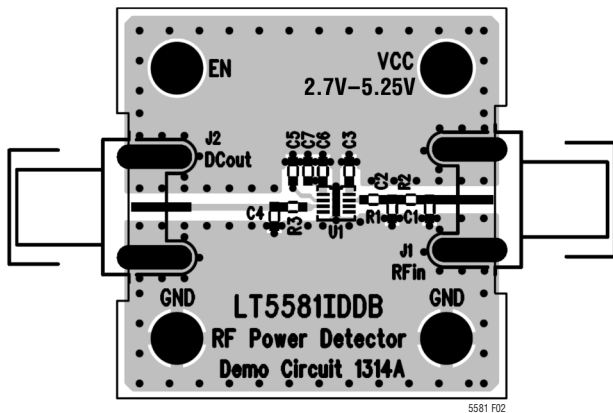

Figure 2. Top Side of Evaluation Board

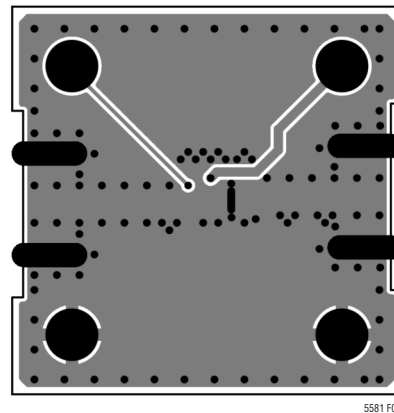

Figure 3. Bottom Side of Evaluation Board

# LT5581

## APPLICATIONS INFORMATION

A shunt  $68\Omega$  resistor can be used to provide a broadband impedance match at low frequencies up to 1.3GHz, and from 4.5GHz to 6GHz. As shown in Figure 4, a nominal broadband input match can be achieved up to 2.2GHz by using an LC matching circuit consisting of a series 2.2nH inductor (L1) and a shunt 1.5pF capacitor (C1). This match will maintain a return loss of about 10dB across the band. For matching at higher frequencies, values for L1 and C1 are listed in the table of Figure 1. The input reflection coefficient referenced to the RF input pin (with no external components) is shown on the Smith Chart in Figure 5. Alternatively, it is possible to match using an impedance transformation network by omitting R1 and transforming the  $205\Omega$  load to  $50\Omega$ . The resulting match, over a narrow band of frequencies, will improve sensitivity up to about 6dB maximum; the dynamic range remains the same. For example, by omitting R1 and setting  $L1 = 1.8\text{nH}$  and  $C1 = 3\text{pF}$ , a 2:1 VSWR match can be obtained from 1.95GHz to 2.36GHz, with a sensitivity improvement of 5dB.

The  $\text{RF}_{\text{IN}}$  input DC blocking capacitor (C2) and the  $\text{C}_{\text{SQ}}$  bias decoupling capacitor (C3), can be adjusted for low

frequency operation. For input frequencies down to 10MHz,  $0.01\mu\text{F}$  is needed at  $\text{C}_{\text{SQ}}$ . For frequencies above 250MHz, the on-chip 20pF decoupling capacitor is sufficient, and  $\text{C}_{\text{SQ}}$  may be eliminated as desired. The DC-blocking capacitor can be as large as 2200pF for 10MHz operation, or 100pF for 2GHz operation. A DC-blocking capacitor larger than 2200pF results in an undesirable RF pulse response on the falling edge. Therefore, for general applications, the recommended value for C2, is conservatively set at 1000pF.

### Output Interface

The output buffer of the LT5581 is shown in Figure 6. It includes a push-pull stage with a series  $300\Omega$  resistor. The output stage is capable of sourcing and sinking 5mA of current. The output pin can be shorted to GND or  $V_{\text{CC}}$  without damage, but going beyond  $V_{\text{CC}} + 0.5\text{V}$  or  $\text{GND} - 0.5\text{V}$  may result in damage, as the internal ESD protection diodes will start to conduct excessive current.

The residual ripple, due to RF modulation, can be reduced by adding external components  $R_{\text{SS}}$  and  $\text{C}_{\text{LOAD}}$  (R3 and C4 on the Evaluation Circuit Schematic in Figure 1) to

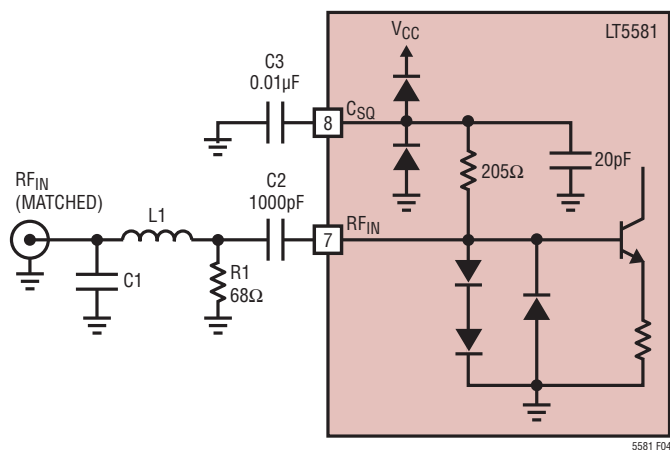

Figure 4. Simplified Circuit Schematic of the RF Input Interface

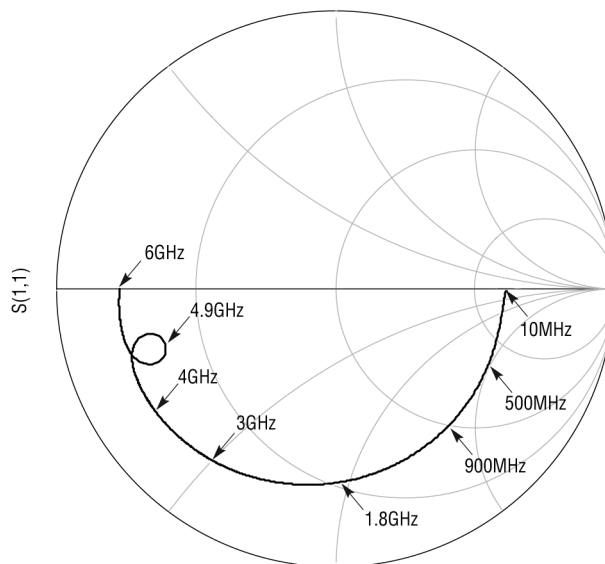

Figure 5. Input Reflection Coefficient

## APPLICATIONS INFORMATION

the output pin, to form an RC lowpass filter. The internal 300Ω resistor in series with the output pin enables filtering of the output signal with just the addition of C<sub>LOAD</sub>. Figure 7 shows the effect of the external filter capacitor on the residual ripple level for a 4-carrier WCDMA signal at 2.14GHz with -10dBm. Adding a 10nF capacitor to the output decreases the peak-to-peak output ripple from 135mV<sub>P-P</sub> to 50mV<sub>P-P</sub>. The filter -3dB corner frequency can be calculated with the following equation:

$$f_c = \frac{1}{2\pi C_{LOAD}(300 + R_{SS})}$$

Figure 8 shows the transient response for a 2.6GHz WiMAX signal, with preamble and burst ripple reduced by a

factor of 3, using a 0.047μF external filter capacitor. The average power in the preamble section is -10dBm, while the burst section has a 3dB lower average power. With the capacitor, the ripple in the preamble section is about 0.5dB peak-to-peak. The modulation used was OFDM (WiMAX 802.16-2004) MMDS band, 1.5MHz BW, with 256 size FFT and 1 burst at QPSK 3/4.

Figure 9 shows how the peak-to-peak ripple decreases with increasing external filter capacitance value. Also shown is how the RF pulse response will have longer rise and fall times with the addition of this lowpass filter cap.

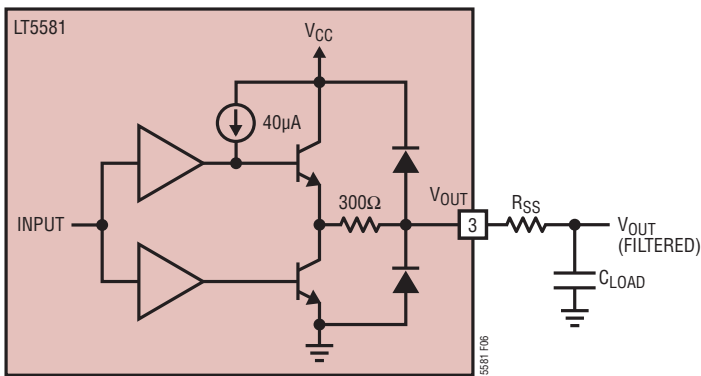

Figure 6. Simplified Circuit Schematic of the Output Interface

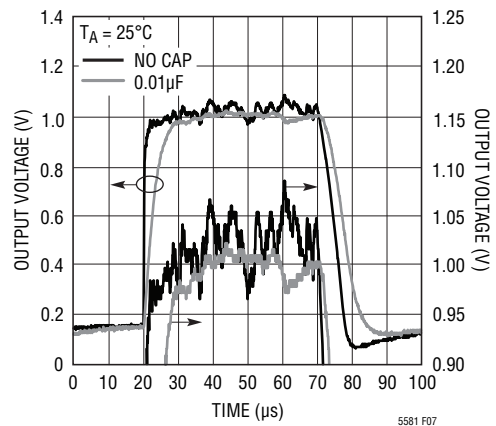

Figure 7. Residual Ripple, Output Transient Response for RF Pulse with WCDMA 4-Carrier Modulation

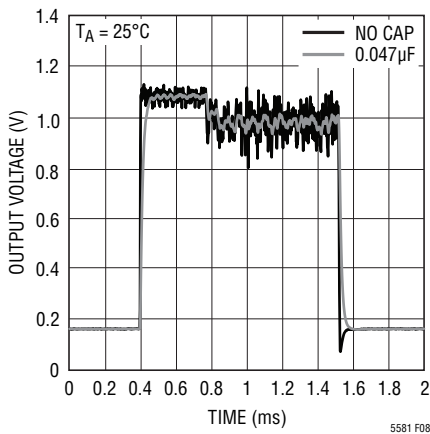

Figure 8. Residual Ripple for 2.6GHz WiMAX OFDM 802.16-2004

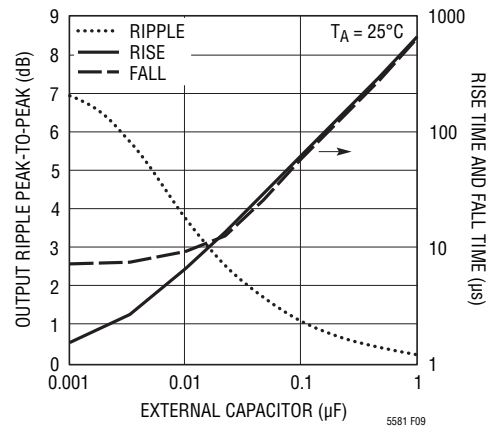

Figure 9. Residual Ripple, Output Transient Times for RF Pulse with WCDMA 4-Carrier Modulation vs External Filter Capacitor C4

# LT5581

## APPLICATIONS INFORMATION

Figure 10 shows that rise time and fall time are strong functions of RF input power. Data is taken without the output filter capacitor.

For a given RF modulation type—WCDMA, for example—the internal 150kHz filter provides nominal filtering of the residual ripple level. Additional external filtering occurs in the log domain, which introduces a systematic log error in relation to the signal’s crest factor, as shown in the following equation in dB.<sup>1</sup>

$$\text{Error[dB]} = 10 \cdot \log_{10}(r + (1 - r)10^{-CF/10}) - CF \cdot (r-1)$$

Where CF is the crest factor and r is the duty cycle of the measurement (or number of measurements made at the peak envelope, divided by the total number of periodic

measurements in the measurement period). It is important to note that the CF refers to the 150kHz low pass filtered envelope of the signal. The error will depend on the statistics and bandwidth of the modulation signal in relation to the internal 150kHz filter. For example, in the case of WCDMA, simulations prove that it is possible to set the external filter capacitor corner frequency at 15kHz and only introduce an error less than 0.1dB.

Figure 11 depicts the output AM modulation ripple as a function of modulation difference frequency for a 2-tone input signal at 2140MHz with -10dBm input power. The resulting deviation in the output voltage of the detector shows the effect of the internal 150kHz filter.

<sup>1</sup> Steve Murray, “Beware of Spectrum Analyzer Power Averaging Techniques,” *Microwaves & RF*, Dec. 2006.

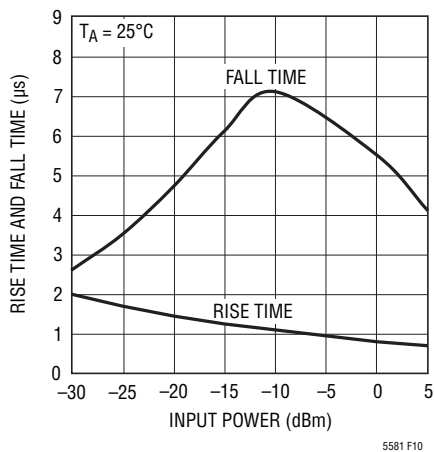

Figure 10. RF Pulse Response Rise Time and Fall Time vs RF Input Power

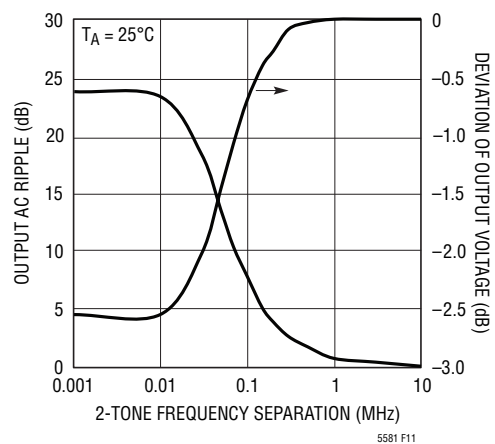

Figure 11. Output DC Voltage Deviation and Residual Ripple vs 2-Tone Separation Frequency

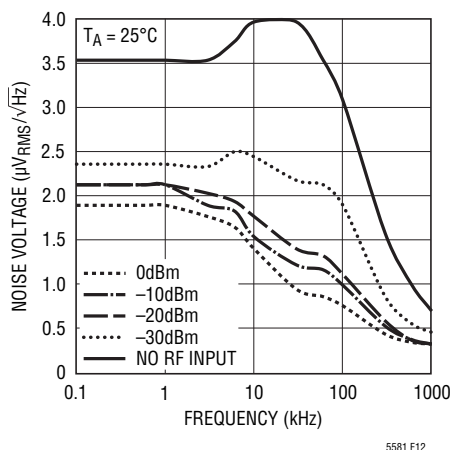

Figure 12. Output Voltage Noise Density

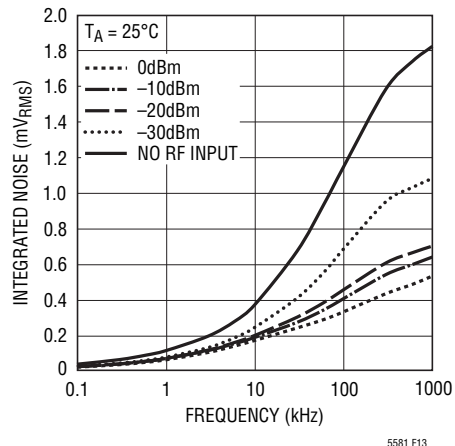

Figure 13. Integrated Output Voltage Noise

## APPLICATIONS INFORMATION

The output voltage noise density and integrated noise are shown in Figures 12 and 13, respectively, for various input power levels. Noise is a strong function of input level. There is roughly a 10dB reduction in the output noise level for an input level of 0dBm versus no input.

### Enable Pin

A simplified schematic of the EN pin is shown in Figure 14. To enable the LT5581, it is necessary to put greater than 2V on this pin. To disable or turn off the chip, this voltage should be below 0.3V. At an enable voltage of 3.3V, the pin draws roughly 20 $\mu$ A. If the EN pin is not connected, the chip is disabled through an internal 500k pull-down resistor.

It is important that the voltage applied to the EN pin never exceeds  $V_{CC}$  by more than 0.5V, otherwise, the supply current may be sourced through the upper ESD protection diode connected at the EN pin.

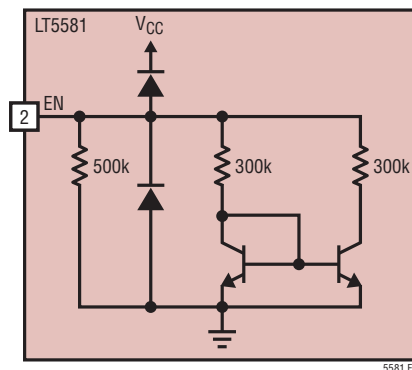

Figure 14. Enable Pin Simplified Schematic

# LT5581

## PACKAGE DESCRIPTION

Please refer to <http://www.linear.com/designtools/packaging/> for the most recent package drawings.

**DDB Package**  
**8-Lead Plastic DFN (3mm × 2mm)**  
 (Reference LTC DWG # 05-08-1702 Rev B)

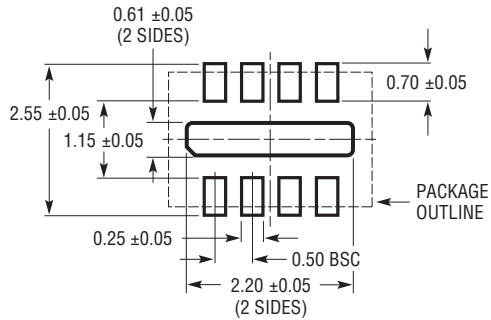

RECOMMENDED SOLDER PAD PITCH AND DIMENSIONS

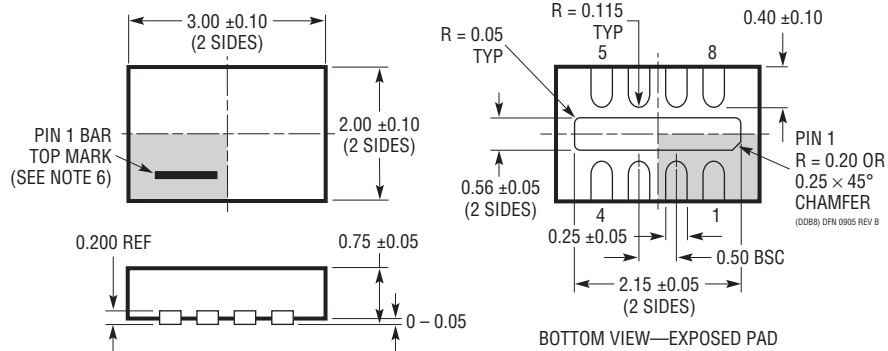

- NOTE:
1. DRAWING CONFORMS TO VERSION (WECD-1) IN JEDEC PACKAGE OUTLINE M0-229
  2. DRAWING NOT TO SCALE
  3. ALL DIMENSIONS ARE IN MILLIMETERS
  4. DIMENSIONS OF EXPOSED PAD ON BOTTOM OF PACKAGE DO NOT INCLUDE MOLD FLASH. MOLD FLASH, IF PRESENT, SHALL NOT EXCEED 0.15mm ON ANY SIDE
  5. EXPOSED PAD SHALL BE SOLDER PLATED
  6. SHADED AREA IS ONLY A REFERENCE FOR PIN 1 LOCATION ON THE TOP AND BOTTOM OF PACKAGE

---

## REVISION HISTORY

REV	DATE	DESCRIPTION	PAGE NUMBER
A	4/10	Updated Note 2 in Electrical Characteristics Section	4
B	8/15	Changed Enable Pin input voltage to 2V	15

## LT5581

## RELATED PARTS

PART NUMBER	DESCRIPTION	COMMENTS
<b>RF Power Detectors</b>		
LTC <sup>®</sup> 5505	RF Power Detectors with >40dB Dynamic Range	300MHz to 3GHz, Temperature Compensated, 2.7V to 6V Supply
LTC5507	100kHz to 1000MHz RF Power Detector	100kHz to 1GHz, Temperature Compensated, 2.7V to 6V Supply
LTC5508	300MHz to 7GHz RF Power Detector	44dB Dynamic Range, Temperature Compensated, SC70 Package
LTC5509	300MHz to 3GHz RF Power Detector	36dB Dynamic Range, Low Power Consumption, SC70 Package
LTC5530	300MHz to 7GHz Precision RF Power Detector	Precision V <sub>OUT</sub> Offset Control, Shutdown, Adjustable Gain
LTC5531	300MHz to 7GHz Precision RF Power Detector	Precision V <sub>OUT</sub> Offset Control, Shutdown, Adjustable Offset
LTC5532	300MHz to 7GHz Precision RF Power Detector	Precision V <sub>OUT</sub> Offset Control, Adjustable Gain and Offset
LT5534	50MHz to 3GHz Log RF Power Detector with 60dB Dynamic Range	±1dB Output Variation over Temperature, 38ns Response Time, Log Linear Response
LTC5536	Precision 600MHz to 7GHz RF Power Detector with Fast Comparator Output	25ns Response Time, Comparator Reference Input, Latch Enable Input, -26dBm to +12dBm Input Range
LT5537	Wide Dynamic Range Log RF/IF Detector	Low Frequency to 1GHz, 83dB Log Linear Dynamic Range
LT5538	75dB Dynamic Range 3.8GHz Log RF Power Detector	±0.8dB Accuracy Over Temperature
<b>Infrastructure</b>		
LT5514	Ultralow Distortion, IF Amplifier/ADC Driver with Digitally Controlled Gain	850MHz Bandwidth, 47dBm OIP3 at 100MHz, 10.5dB to 33dB Gain Control Range
LT5517	40MHz to 900MHz Quadrature Demodulator	21dBm IIP3, Integrated LO Quadrature Generator
LT5519	0.7GHz to 1.4GHz High Linearity Upconverting Mixer	17.1dBm IIP3 at 1GHz, Integrated RF Output Transformer with 50Ω Matching, Single-Ended LO and RF Ports Operation
LT5520	1.3GHz to 2.3GHz High Linearity Upconverting Mixer	15.9dBm IIP3 at 1.9GHz, Integrated RF Output Transformer with 50Ω Matching, Single-Ended LO and RF Ports Operation
LT5521	10MHz to 3700MHz High Linearity Upconverting Mixer	24.2dBm IIP3 at 1.95GHz, NF = 12.5dB, 3.15V to 5.25V Supply, Single-Ended LO Port Operation
LT5522	600MHz to 2.7GHz High Signal Level Downconverting Mixer	4.5V to 5.25V Supply, 25dBm IIP3 at 900MHz, NF = 12.5dB, 50Ω Single-Ended RF and LO Ports
LT5525	High Linearity, Low Power Downconverting Mixer	Single-Ended 50Ω RF and LO Ports, 17.6dBm IIP3 at 1900MHz, I <sub>CC</sub> = 28mA
LT5526	High Linearity, Low Power Downconverting Mixer	3V to 5.3V Supply, 16.5dBm IIP3, 100kHz to 2GHz RF, NF = 11dB, I <sub>CC</sub> = 28mA, -65dBm LO-RF Leakage
LT5527	400MHz to 3.7GHz High Signal Level Downconverting Mixer	IIP3 = 23.5dBm and NF = 12.5dBm at 1900MHz, 4.5V to 5.25V Supply, I <sub>CC</sub> = 78mA, Conversion Gain = 2dB
LT5557	400MHz to 3.8GHz, 3.3V High Signal Level Downconverting Mixer	IIP3 = 23.7dBm at 2600MHz, 23.5dBm at 3600MHz, I <sub>CC</sub> = 82mA at 3.3V
LT5560	Ultralow Power Active Mixer	10mA Supply Current, 10dBm IIP3, 10dB NF, Usable as Up- or Down-Converter.
LT5568	700MHz to 1050MHz High Linearity Direct Quadrature Modulator	22.9dBm OIP3 at 850MHz, -160.3dBm/Hz Noise Floor, 50Ω, 0.5V <sub>DC</sub> Baseband Interface, 3-Ch CDMA2000 ACPR = -71.4dBc at 850MHz
LT5572	1.5GHz to 2.5GHz High Linearity Direct Quadrature Modulator	21.6dBm OIP3 at 2GHz, -158.6dBm/Hz Noise Floor, High-Ohmic 0.5V <sub>DC</sub> Baseband Interface, 4-Ch W-CDMA ACPR = -67.7dBc at 2.14GHz
LT5575	800MHz to 2.7GHz High Linearity Direct Conversion I/Q Demodulator	50Ω, Single-Ended RF and LO Inputs. 28dBm IIP3 at 900MHz, 13.2dBm P1dB, 0.04dB I/Q Gain Mismatch, 0.4° I/Q Phase Mismatch

## OUR CERTIFICATE

DiGi provide top-quality products and perfect service for customer worldwide through standardization, technological innovation and continuous improvement. DiGi through third-party certification, we stricly control the quality of products and services. Welcome your RFQ to

Email: [Info@DiGi-Electronics.com](mailto:Info@DiGi-Electronics.com)



Tel: +00 852-30501935

RFQ Email: [Info@DiGi-Electronics.com](mailto:Info@DiGi-Electronics.com)

DiGi is a global authorized distributor of electronic components.