

LTC2908CDDDB-B1#TRPBF Datasheet

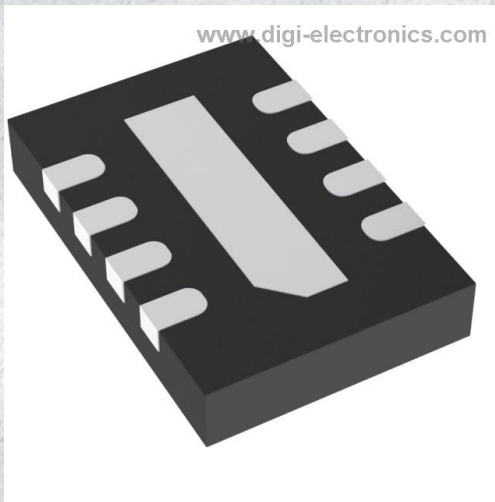

<https://www.DiGi-Electronics.com>

DiGi Electronics Part Number	LTC2908CDDDB-B1#TRPBF-DG
Manufacturer	Analog Devices Inc.
Manufacturer Product Number	LTC2908CDDDB-B1#TRPBF
Description	IC SUPERVISOR 6 CHANNEL 8DFN
Detailed Description	Supervisor Open Drain or Open Collector 6 Channel 8-DFN (3x2)

This model LTC2908CDDDB-B1#TRPBF is available at DiGi Electronics.

DiGi Electronics offers a global database of semiconductor and electronic component datasheets.

We welcome your inquiries regarding pricing, lead time, or other product-related questions.

 [Request a Quote](#)

 [Datasheet Search](#)



Tel: +00 852-30501935

RFQ Email: Info@DiGi-Electronics.com

DiGi is a global authorized distributor of electronic components.

Purchase and inquiry

Manufacturer Product Number:

LTC2908CDDDB-B1#TRPBF

Series:

-

DiGi-Electronics Programmable:

Not Verified

Number of Voltages Monitored:

6

Output:

Open Drain or Open Collector

Reset Timeout:

160ms Minimum

Mounting Type:

Surface Mount

Supplier Device Package:

8-DFN (3x2)

Manufacturer:

Analog Devices Inc.

Product Status:

Active

Type:

Multi-Voltage Supervisor

Voltage - Threshold:

1.403V, 1.683V, 2.338V, 3.086V, Adj, Adj

Reset:

Active Low

Operating Temperature:

0°C ~ 70°C (TA)

Package / Case:

8-WDFDN Exposed Pad

Base Product Number:

LTC2908

Environmental & Export classification

RoHS Status:

ROHS3 Compliant

REACH Status:

REACH Unaffected

HTSUS:

8542.39.0001

Moisture Sensitivity Level (MSL):

1 (Unlimited)

ECCN:

EAR99

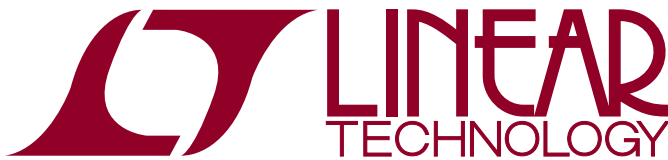

LTC2908

Precision Six Input Supply Monitor

FEATURES

- **Ultralow Voltage Reset: $V_{CC} = 0.5V$ Guaranteed***
- **Monitors Six Inputs Simultaneously:**
5V, 3.3V, 2.5V, 1.8V, ADJ1, ADJ2 (LTC2908-A1)
3.3V, 2.5V, 1.8V, 1.5V, ADJ1, ADJ2 (LTC2908-B1)
2.5V, ADJ1, ADJ2, ADJ3, ADJ4, ADJ5 (LTC2908-C1)
- **Guaranteed Threshold Accuracy: $\pm 1.5\%$ of Monitored Voltage**
- **Internal V_{CC} Auto Select**
- Power Supply Glitch Immunity
- 200ms Reset Time Delay
- Active Low Open-Drain \overline{RST} Output
- Low Profile (1mm) 8-Lead SOT-23 (ThinSOT™) and Plastic (3mm × 2mm) DFN Packages

APPLICATIONS

- Network Servers
- Wireless Base Stations
- Optical Networking Systems
- Multivoltage Systems
- Desktop and Notebook Computers

DESCRIPTION

The LTC[®]2908 is a six input supply monitor for systems requiring a precise and compact monitoring solution for multiple supply voltages. The inputs can be shorted together for monitoring systems with fewer than six supply voltages, and the open drain \overline{RST} output of two or more LTC2908s can be wired-OR together for monitoring systems with more than six supply voltages. The common reset output remains low until all six inputs have been in compliance for 200ms.

The LTC2908 features a tight 1.5% threshold accuracy over the entire operating temperature range and glitch immunity to ensure reliable reset operation without false triggering. The open-drain \overline{RST} output state is guaranteed to be in the correct state as long as V1 and/or V2 is 0.5V or greater.

The LTC2908 also features adjustable inputs with a nominal threshold level at 0.5V. This product provides a precise, space-conscious, micropower and general purpose solution for any kind of system requiring supply monitors.

LT, LT, LTC, LTM, Linear Technology and the Linear logo are registered trademarks of Linear Technology Corporation. ThinSOT is a trademark of Linear Technology Corporation. All other trademarks are the property of their respective owners. *Patent pending.

TYPICAL APPLICATION

Six Supply Monitor with 5% Tolerance
(12V, 3.3V, 2.5V, 1.8V, 1.5V, 1.2V)

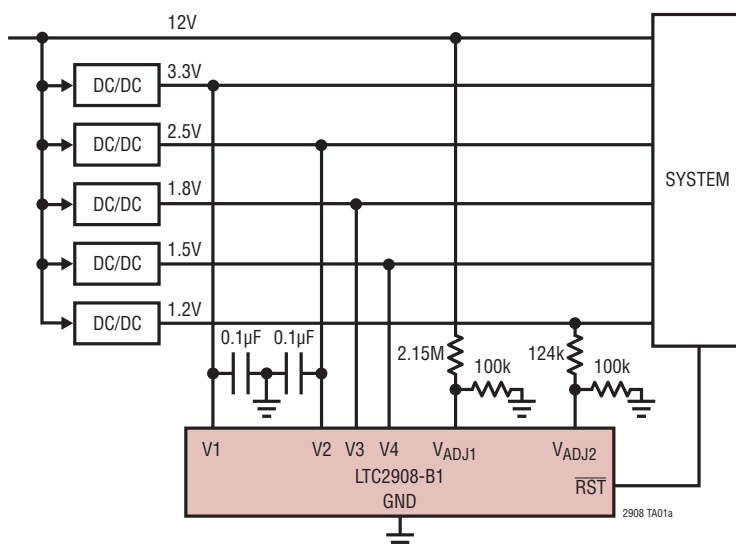

\overline{RST} Output Voltage vs V1
with 10k Pull-Up Resistor to V1

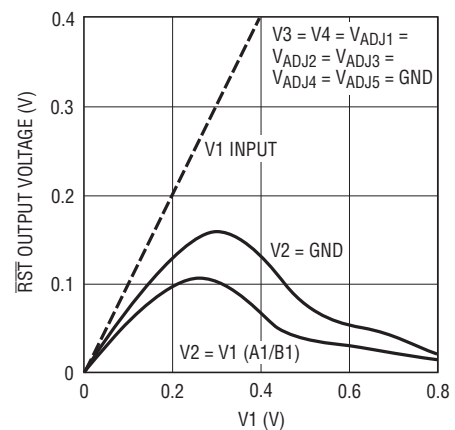

2908fd

LTC2908

ABSOLUTE MAXIMUM RATINGS (Notes 1, 2)

Terminal Voltages

V1, V2, V3, V4	-0.3V to 7V
V _{ADJ1} , V _{ADJ2} , V _{ADJ3} ,	-0.3V to (V _{CC} + 0.6V)
V _{ADJ4} , V _{ADJ5}	-0.3V to (V _{CC} + 0.6V)
RST	-0.3V to 7V

Storage Temperature Range

DFN Package.....	-65°C to 125°C
TSOT-23 Package.....	-65°C to 150°C
Lead Temperature (Soldering, 10 sec)	300°C

Operating Temperature Range

LTC2908C	0°C to 70°C
LTC2908I.....	-40°C to 85°C

PIN CONFIGURATION

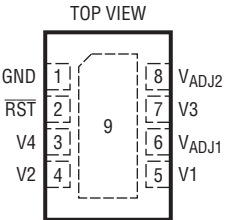
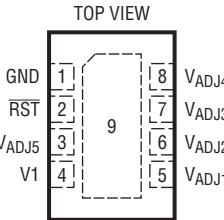
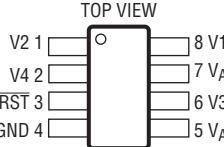
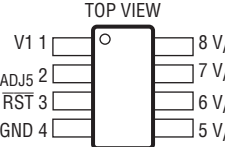
<p>LTC2908CDDB-A1 LTC2908IDDB-A1 LTC2908CDDB-B1 LTC2908IDDB-B1</p>  <p>DDB8 PACKAGE 8-LEAD (3mm × 2mm) PLASTIC DFN T_{JMAX} = 125°C, θ_{JA} = 76°C/W EXPOSED PAD (PIN 9) (PCB CONNECTION OPTIONAL)</p>	<p>LTC2908CDDB-C1 LTC2908IDDB-C1</p>  <p>DDB8 PACKAGE 8-LEAD (3mm × 2mm) PLASTIC DFN T_{JMAX} = 125°C, θ_{JA} = 76°C/W EXPOSED PAD (PIN 9) (PCB CONNECTION OPTIONAL)</p>	<p>LTC2908CTS8-A1 LTC2908ITS8-A1 LTC2908CTS8-B1 LTC2908ITS8-B1</p>  <p>TS8 PACKAGE 8-LEAD PLASTIC TSOT-23 T_{JMAX} = 125°C, θ_{JA} = 250°C/W</p>	<p>LTC2908CTS8-C1 LTC2908ITS8-C1</p>  <p>TS8 PACKAGE 8-LEAD PLASTIC TSOT-23 T_{JMAX} = 125°C, θ_{JA} = 250°C/W</p>
--	--	---	--

ORDER INFORMATION

Lead Free Finish

TAPE AND REEL (MINI)	TAPE AND REEL	PART MARKING*	PACKAGE DESCRIPTION	TEMPERATURE RANGE
LTC2908CDDB-A1#TRMPBF	LTC2908CDDB-A1#TRPBF	LBFD	8-LEAD (3mm × 2mm) PLASTIC DFN	0°C to 70°C
LTC2908IDDB-A1#TRMPBF	LTC2908IDDB-A1#TRPBF	LBFF	8-LEAD (3mm × 2mm) PLASTIC DFN	-40°C to 85°C
LTC2908CDDB-B1#TRMPBF	LTC2908CDDB-B1#TRPBF	LBFG	8-LEAD (3mm × 2mm) PLASTIC DFN	0°C to 70°C
LTC2908IDDB-B1#TRMPBF	LTC2908IDDB-B1#TRPBF	LBFH	8-LEAD (3mm × 2mm) PLASTIC DFN	-40°C to 85°C
LTC2908CDDB-C1#TRMPBF	LTC2908CDDB-C1#TRPBF	LCFV	8-LEAD (3mm × 2mm) PLASTIC DFN	0°C to 70°C
LTC2908IDDB-C1#TRMPBF	LTC2908IDDB-C1#TRPBF	LCFV	8-LEAD (3mm × 2mm) PLASTIC DFN	-40°C to 85°C
LTC2908CTS8-A1#TRMPBF	LTC2908CTS8-A1#TRPBF	LTBFJ	8-LEAD PLASTIC TSOT-23	0°C to 70°C
LTC2908ITS8-A1#TRMPBF	LTC2908ITS8-A1#TRPBF	LTBFK	8-LEAD PLASTIC TSOT-23	-40°C to 85°C
LTC2908CTS8-B1#TRMPBF	LTC2908CTS8-B1#TRPBF	LTBFM	8-LEAD PLASTIC TSOT-23	0°C to 70°C
LTC2908ITS8-B1#TRMPBF	LTC2908ITS8-B1#TRPBF	LTBFN	8-LEAD PLASTIC TSOT-23	-40°C to 85°C
LTC2908CTS8-C1#TRMPBF	LTC2908CTS8-C1#TRPBF	LTCFT	8-LEAD PLASTIC TSOT-23	0°C to 70°C
LTC2908ITS8-C1#TRMPBF	LTC2908ITS8-C1#TRPBF	LTCFT	8-LEAD PLASTIC TSOT-23	-40°C to 85°C

TRM = 500 pieces. *Temperature grades are identified by a label on the shipping container.

Consult LTC Marketing for parts specified with wider operating temperature ranges.

Consult LTC Marketing for information on lead based finish parts.

For more information on lead free part marking, go to: <http://www.linear.com/leadfree/>

For more information on tape and reel specifications, go to: <http://www.linear.com/tapeandreel/>

2908fd

ELECTRICAL CHARACTERISTICS

(LTC2908-A1) The ● denotes specifications which apply over the full operating temperature range, otherwise specifications are $T_A = 25^\circ\text{C}$, $V_{CC} = 5\text{V}$ unless otherwise noted. (Note 2)

SYMBOL	PARAMETER	CONDITIONS	MIN	TYP	MAX	UNITS
V_{RT50}	5V, 5% Reset Threshold	V1 Input Threshold	● 4.600	4.675	4.750	V
V_{RT33}	3.3V, 5% Reset Threshold	V2 Input Threshold	● 3.036	3.086	3.135	V
V_{RT25}	2.5V, 5% Reset Threshold	V3 Input Threshold	● 2.300	2.338	2.375	V
V_{RT18}	1.8V, 5% Reset Threshold	V4 Input Threshold	● 1.656	1.683	1.710	V
V_{RTADJ}	ADJ, 5% Reset Threshold	V_{ADJ1} , V_{ADJ2} Input Threshold	● 0.492	0.500	0.508	V

(LTC2908-B1) The ● denotes specifications which apply over the full operating temperature range, otherwise specifications are $T_A = 25^\circ\text{C}$, $V_{CC} = 3.3\text{V}$ unless otherwise noted. (Note 2)

SYMBOL	PARAMETER	CONDITIONS	MIN	TYP	MAX	UNITS
V_{RT33}	3.3V, 5% Reset Threshold	V1 Input Threshold	● 3.036	3.086	3.135	V
V_{RT25}	2.5V, 5% Reset Threshold	V2 Input Threshold	● 2.300	2.338	2.375	V
V_{RT18}	1.8V, 5% Reset Threshold	V3 Input Threshold	● 1.656	1.683	1.720	V
V_{RT15}	1.5V, 5% Reset Threshold	V4 Input Threshold	● 1.380	1.403	1.425	V
V_{RTADJ}	ADJ, 5% Reset Threshold	V_{ADJ1} , V_{ADJ2} Input Threshold	● 0.492	0.500	0.508	V

(LTC2908-C1) The ● denotes specifications which apply over the full operating temperature range, otherwise specifications are $T_A = 25^\circ\text{C}$, $V_{CC} = 2.5\text{V}$ unless otherwise noted. (Note 2)

SYMBOL	PARAMETER	CONDITIONS	MIN	TYP	MAX	UNITS
V_{RT25}	2.5V, 5% Reset Threshold	V1 Input Threshold	● 2.300	2.338	2.375	V
V_{RTADJ}	ADJ, 5% Reset Threshold	V_{ADJ1} , V_{ADJ2} , V_{ADJ3} , V_{ADJ4} , V_{ADJ5} , Input Threshold	● 0.492	0.500	0.508	V

The ● denotes specifications which apply over the full operating temperature range, otherwise specifications are $T_A = 25^\circ\text{C}$. $V_{CC} = 5\text{V}$ for the LTC2908-A1, $V_{CC} = 3.3\text{V}$ for the LTC2908-B1 or $V_{CC} = 2.5\text{V}$ for the LTC2908-C1, unless otherwise noted. (Notes 2, 3)

SYMBOL	PARAMETER	CONDITIONS	MIN	TYP	MAX	UNITS
V_{CC}	Internal Supply Voltage	$\overline{\text{RST}}$ in Correct Logic State	● 0.5		6	V
I_{V1}	V1 Input Current (Note 4)	V1 = 5.0V (LTC2908-A1)	●	26	70	μA
		V1 = 3.3V (LTC2908-B1)	●	24	70	μA
		V1 = 2.5V (LTC2908-C1)	●	22	70	μA
I_{V2}	V2 Input Current (Note 4)	V2 = 3.3V (LTC2908-A1)	●	10	30	μA
		V2 = 2.5V (LTC2908-B1)	●	8	30	μA
I_{V3}	V3 Input Current	V3 = 2.5V (LTC2908-A1)	●	2	5	μA
		V3 = 1.8V (LTC2908-B1)	●	2	5	μA
I_{V4}	V4 Input Current	V4 = 1.8V (LTC2908-A1)	●	2	5	μA
		V4 = 1.5V (LTC2908-B1)	●	2	5	μA
I_{VADJ}	V_{ADJ1} , V_{ADJ2} , V_{ADJ3} , V_{ADJ4} , V_{ADJ5} Input Current	$V_{ADJ1} = V_{ADJ2} = V_{ADJ3} = V_{ADJ4} = V_{ADJ5} =$ 0.55V	●		±15	nA

LTC2908

ELECTRICAL CHARACTERISTICS

The ● denotes specifications which apply over the full operating temperature range, otherwise specifications are $T_A = 25^\circ\text{C}$. $V_{CC} = 5\text{V}$ for the LTC2908-A1, $V_{CC} = 3.3\text{V}$ for the LTC2908-B1 or $V_{CC} = 2.5\text{V}$ for the LTC2908-C1, unless otherwise noted. (Notes 2, 3)

SYMBOL	PARAMETER	CONDITIONS	MIN	TYP	MAX	UNITS
t_{RST}	Reset Time-Out Period		● 160	200	260	ms
t_{UV}	V_X Undervoltage Detect to \overline{RST}	V_X Less Than Reset Threshold V_{RTX} by More Than 1%		250		μs
V_{OH}	Output Voltage High \overline{RST} (Note 5)	$I_{\overline{RST}} = -1\mu\text{A}$, $V_{CC} = 5\text{V}$ (LTC2908-A1) $I_{\overline{RST}} = -1\mu\text{A}$, $V_{CC} = 3.3\text{V}$ (LTC2908-B1) $I_{\overline{RST}} = -1\mu\text{A}$, $V_{CC} = 2.5\text{V}$ (LTC2908-C1)	● $V_{CC} - 1.5$ ● $V_{CC} - 1.0$ ● $V_{CC} - 1.0$			V V V
V_{OL}	Output Voltage Low \overline{RST}	$V_{CC} = 0.5\text{V}$, $I_{\overline{RST}} = 5\mu\text{A}$ $V_{CC} = 1.0\text{V}$, $I_{\overline{RST}} = 100\mu\text{A}$ $V_{CC} = 3.0\text{V}$, $I_{\overline{RST}} = 2500\mu\text{A}$	● ● ●	0.01 0.01 0.10	0.15 0.15 0.30	V V V

Note 1: Stresses beyond those listed under Absolute Maximum Ratings may cause permanent damage to the device. Exposure to any Absolute Maximum Rating condition for extended periods may affect device reliability and lifetime.

Note 2: The greater of V_1 , V_2 is the internal supply voltage (V_{CC}) for the LTC2908-A1 and the LTC2908-B1. V_1 is the internal supply voltage (V_{CC}) for the LTC2908-C1.

Note 3: All currents into pins are positive; all voltages are referenced to GND unless otherwise noted.

Note 4: Under typical operating conditions, most of the quiescent current is drawn from the V_1 input. When V_2 exceeds V_1 , V_2 supplies most of the quiescent current.

Note 5: The output pin \overline{RST} has an internal pull-up to V_{CC} of typically $6\mu\text{A}$. However, an external pull-up resistor may be used when a faster rise time is required or for V_{OH} voltages greater than V_{CC} .

TYPICAL PERFORMANCE CHARACTERISTICS

Specifications are at $T_A = 25^\circ\text{C}$ unless otherwise noted.

5V Threshold Voltage vs Temperature

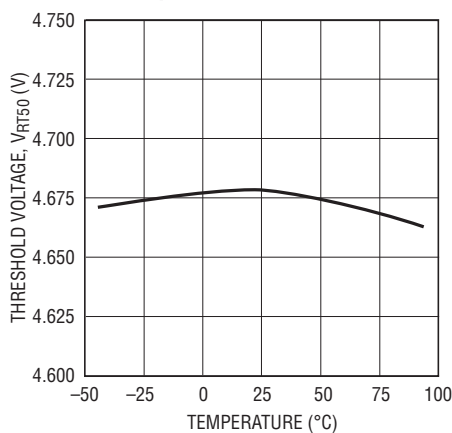

2908 G01

3.3V Threshold Voltage vs Temperature

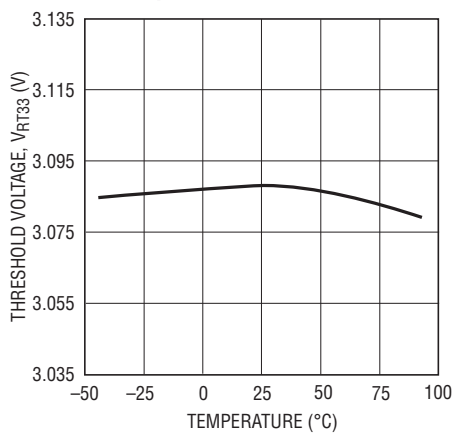

2908 G02

2.5V Threshold Voltage vs Temperature

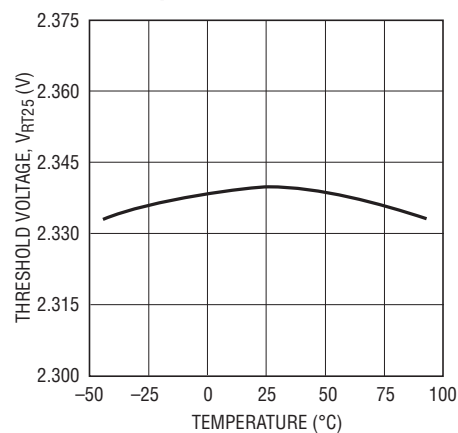

2908 G03

2908fd

TYPICAL PERFORMANCE CHARACTERISTICS

Specifications are at $T_A = 25^\circ\text{C}$ unless otherwise noted.

1.8V Threshold Voltage vs Temperature

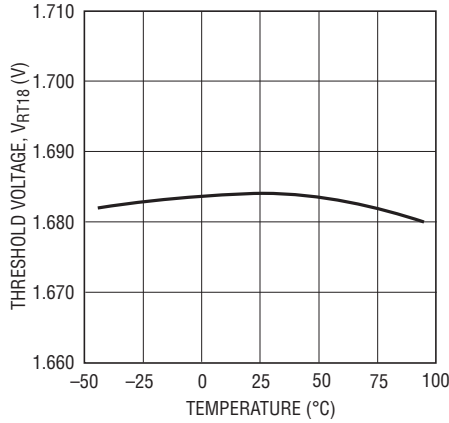

1.5V Threshold Voltage vs Temperature

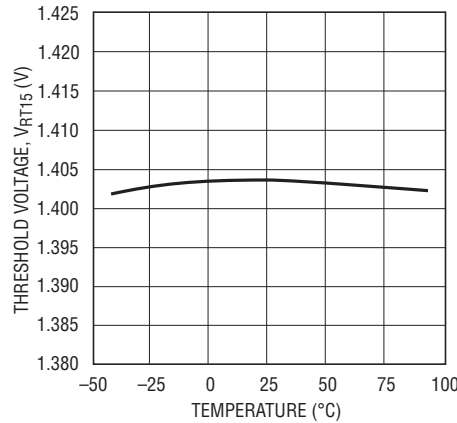

ADJ Threshold Voltage vs Temperature

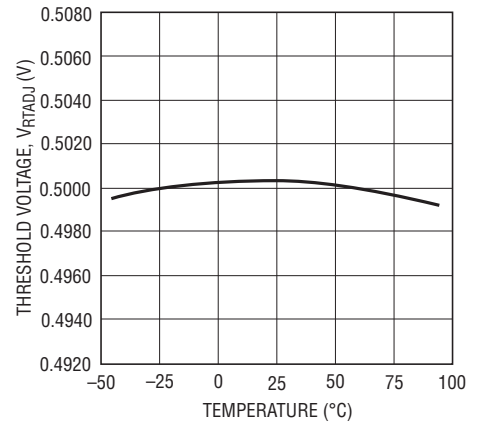

I_{V1} vs Temperature

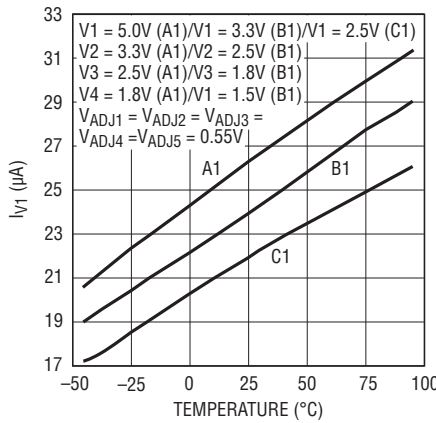

I_{V2} vs Temperature

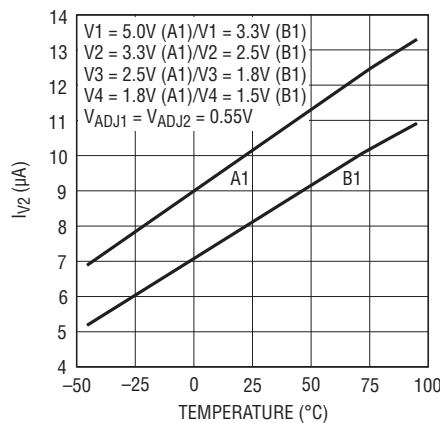

I_{V3} vs Temperature

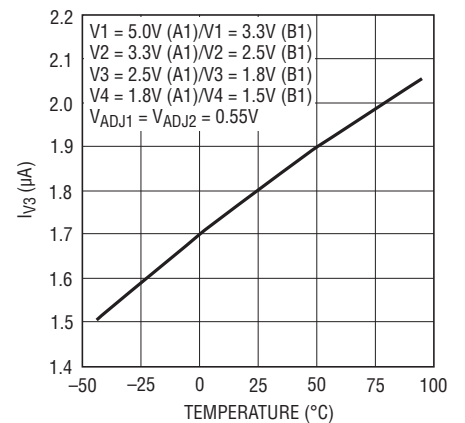

I_{V4} vs Temperature

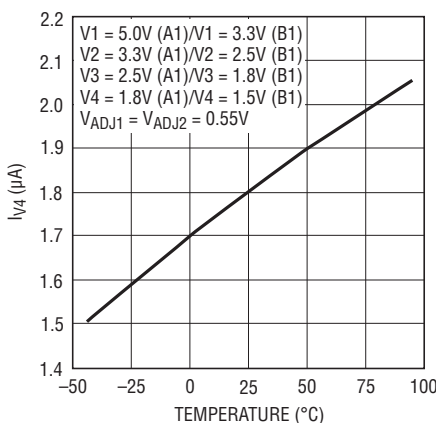

Typical Transient Duration vs Comparator Overdrive

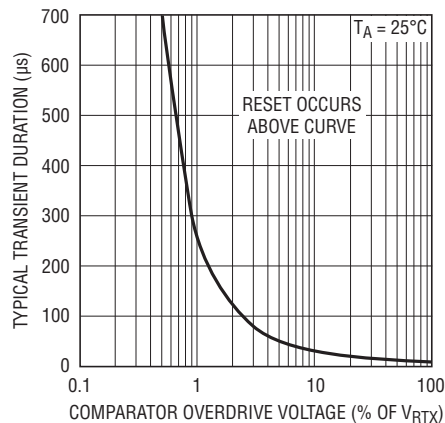

Reset Time-Out Period (t_{RST}) vs Temperature

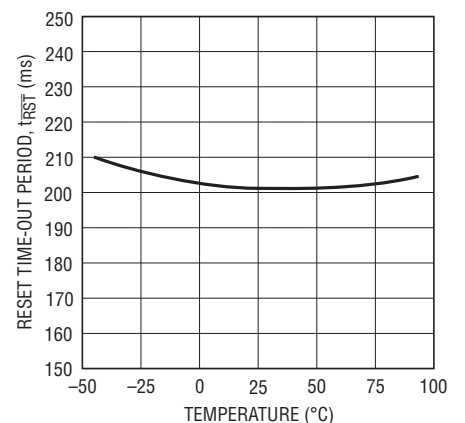

LTC2908

TYPICAL PERFORMANCE CHARACTERISTICS

Specifications are at $T_A = 25^\circ\text{C}$ unless otherwise noted.

RST Output Voltage vs V1 with 10k Pull-Up Resistor to V1

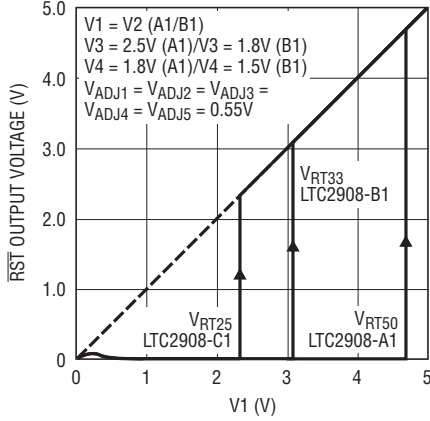

2908 G13

RST Output Voltage vs V1 with 10k Pull-Up Resistor to V1

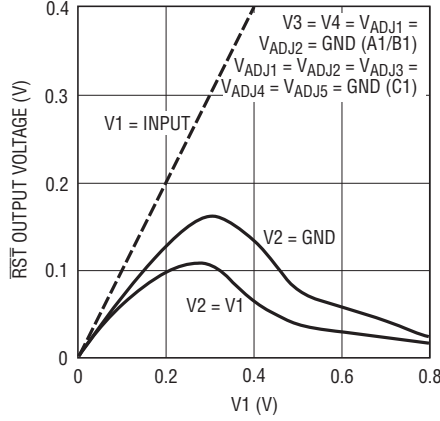

2908 G14

RST Pull-Down Current vs Supply Voltage LTC2908-A1/LTC2908-B1

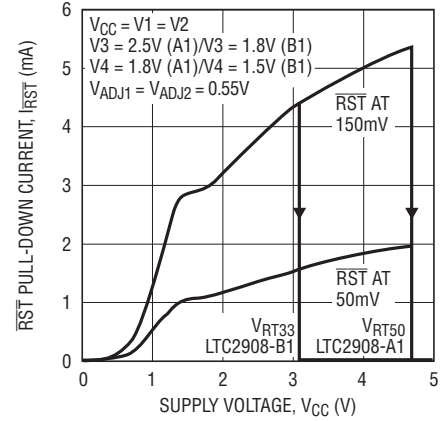

2908 G15

RST Pull-Down Current vs Supply Voltage LTC2908-C1

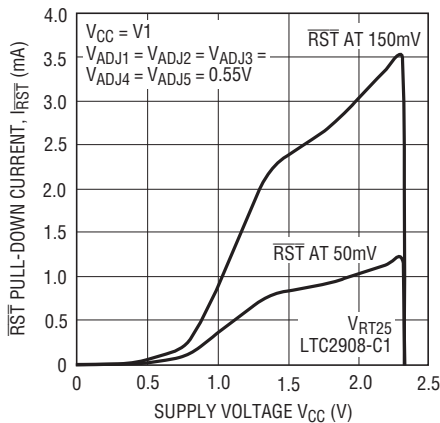

2928 G25

RST Pull-Down Current vs Supply Voltage with 2 Inputs LTC2908-A1/LTC2908-B1

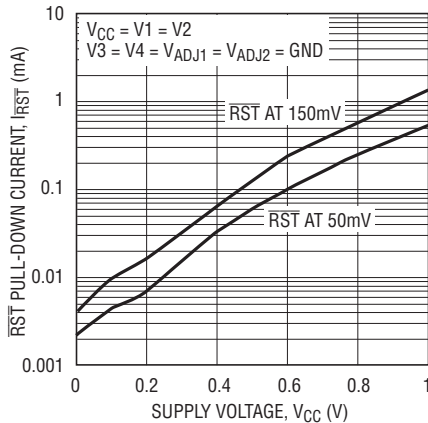

2908 G16

RST Pull-Down Current vs Supply Voltage with 1 Input

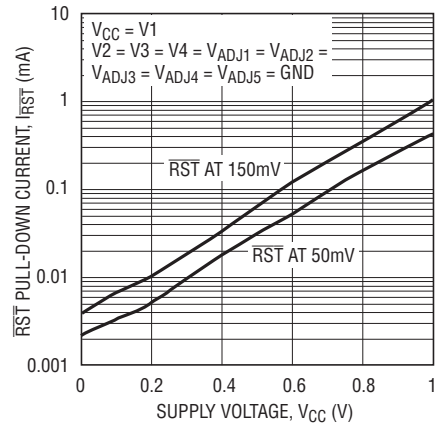

2908 G17

RST Output Voltage Low vs RST Pull-Down Current LTC2908-A1

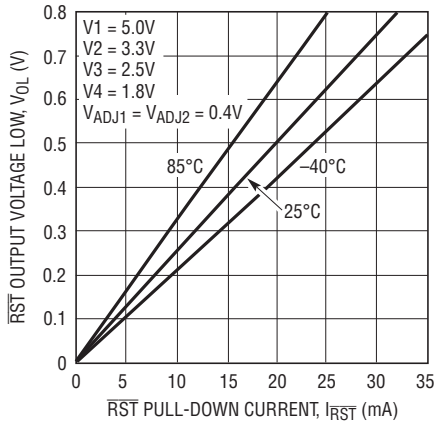

2908 G18

RST Output Voltage Low vs RST Pull-Down Current LTC2908-B1

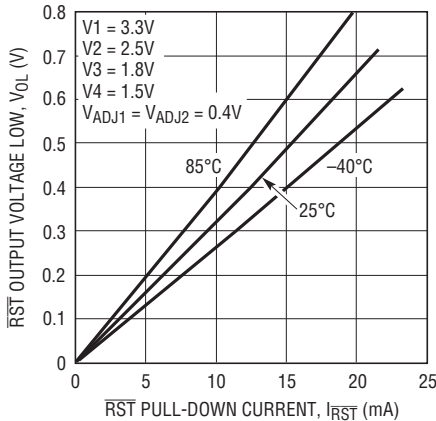

2908 G19

RST Output Voltage Low vs RST Pull-Down Current LTC2908-C1

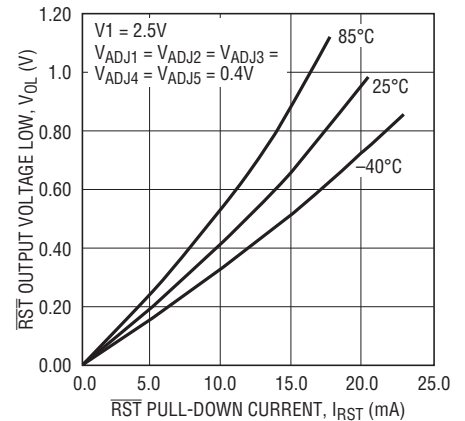

2908 G23

2908fd

TYPICAL PERFORMANCE CHARACTERISTICS

Specifications are at $T_A = 25^\circ\text{C}$ unless otherwise noted.

RST Pull-Up Current vs Supply Voltage

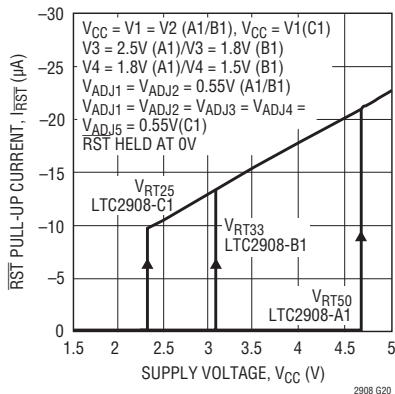

RST Output Voltage High vs RST Output Source Current LTC2908-A1

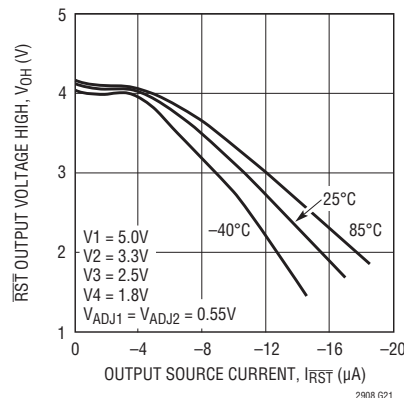

RST Output Voltage High vs RST Output Source Current LTC2908-B1

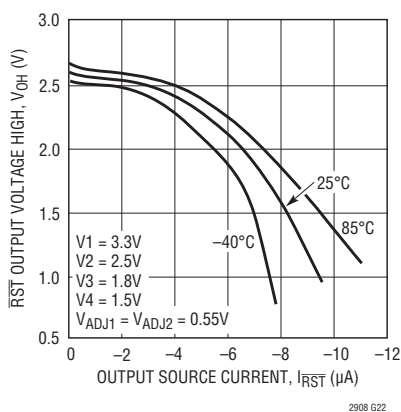

RST Output Voltage High vs RST Output Source Current LTC2908-C1

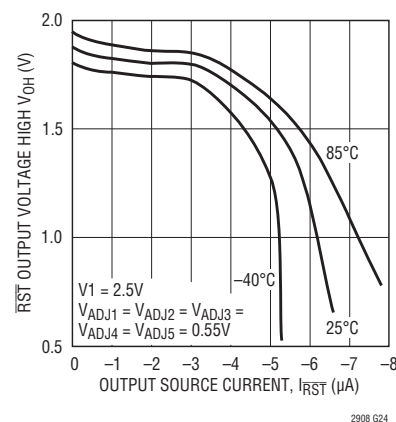

PIN FUNCTIONS (TS8 Package/DDB8 Package) LTC2908-A1/LTC2908-B1

V2 (Pin 1/Pin 4): Voltage Input 2. The greater of V_1 , V_2 is also the internal V_{CC} . The operating voltage on this pin shall not exceed 6V. When in normal operation ($V_1 > V_2$), this pin draws approximately $8\mu\text{A}$. When this pin is acting as the V_{CC} ($V_2 > V_1$), this pin draws an additional $16\mu\text{A}$. Bypass this pin to ground with a $0.1\mu\text{F}$ (or greater) capacitor.

V4 (Pin 2/Pin 3): Voltage Input 4.

RST (Pin 3/Pin 2): Reset Logic Output. Pulls low when any voltage input is below the reset threshold and is held low for 200ms after all voltage inputs are above threshold. This pin has a weak pull-up to V_{CC} and may be pulled above V_{CC} using an external pull-up.

GND (Pin 4/Pin 1): Device Ground.

V_{ADJ2} (Pin 5/Pin 8): Adjustable Voltage Input 2. See Table 1 for recommended ADJ resistors values.

V3 (Pin 6/Pin 7): Voltage Input 3.

V_{ADJ1} (Pin 7/Pin 6): Adjustable Voltage Input 1. See Table 1 for recommended ADJ resistors values.

V1 (Pin 8/Pin 5): Voltage Input 1. The greater of V_1 , V_2 is also the internal V_{CC} . The operating voltage on this pin shall not exceed 6V. When in normal operation ($V_1 > V_2$), this pin draws approximately $26\mu\text{A}$. When this pin is not acting as the V_{CC} ($V_2 > V_1$), this pin draws approximately $8\mu\text{A}$. Bypass this pin to ground with a $0.1\mu\text{F}$ (or greater) capacitor.

Exposed Pad (Pin 9, DDB8 Only): Exposed pad may be left open or connected to device ground.

2908fd

LTC2908

PIN FUNCTIONS (TS8 Package/DDB8 Package) LTC2908-C1

V1 (Pin 1/Pin 4): Voltage Input 1. V1 is the internal V_{CC} . The operating voltage on this pin shall not exceed 6V. When in normal operation, this pin draws approximately 22 μ A. Bypass this pin to ground with a 0.1 μ F (or greater) capacitor.

V_{ADJ5} (Pin 2/Pin 3): Adjustable Voltage Input 5. See Table 1 for recommended ADJ resistors values.

RST (Pin 3/Pin 4): Reset Logic Output. Pulls low when any voltage input is below the reset threshold and is held low for 200ms after all voltage inputs are above threshold. This pin has a weak pull-up to V_{CC} and may be pulled above V_{CC} using an external pull-up.

GND (Pin 4/Pin 1): Device Ground.

V_{ADJ4} (Pin 5/Pin 8): Adjustable Voltage Input 4. See Table 1 for recommended ADJ resistors values.

V_{ADJ3} (Pin 6/Pin 7): Adjustable Voltage Input 3. See Table 1 for recommended ADJ resistors values.

V_{ADJ2} (Pin 7/Pin 6): Adjustable Voltage Input 2. See Table 1 for recommended ADJ resistors values.

V_{ADJ1} (Pin 8/Pin 5): Adjustable Voltage Input 1. See Table 1 for recommended ADJ resistors values.

Exposed Pad (Pin 9, DDB8 Only): Exposed pad may be left open or connected to device ground.

BLOCK DIAGRAMS

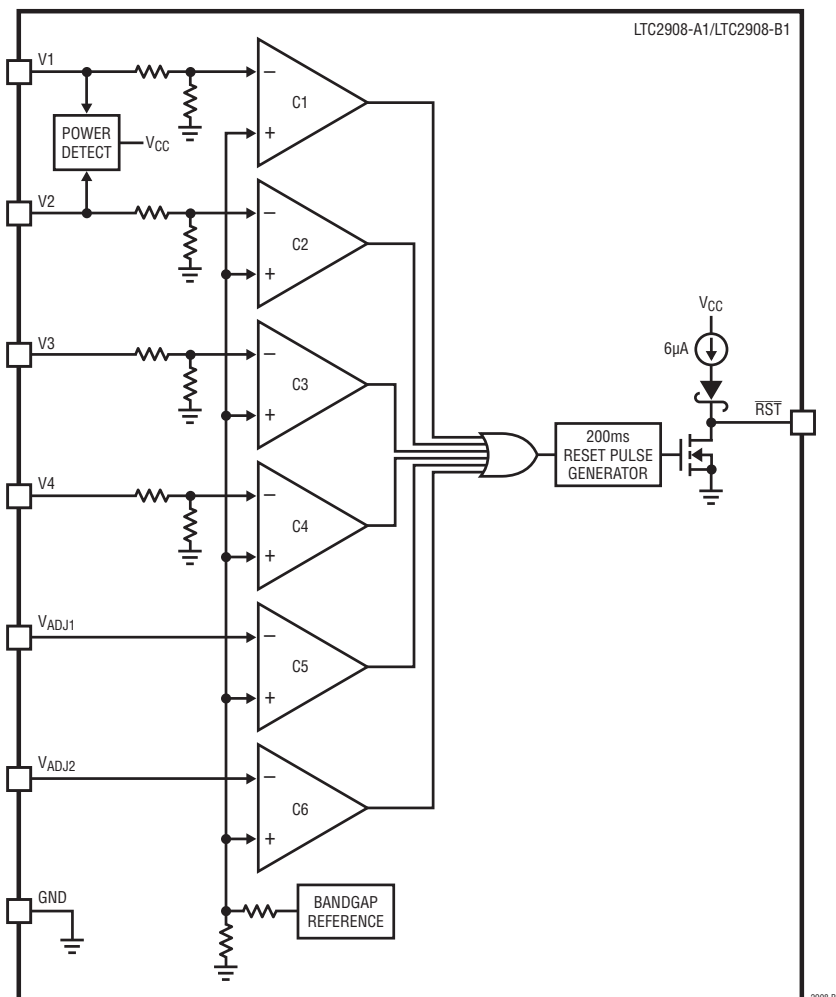

2908fd

BLOCK DIAGRAMS

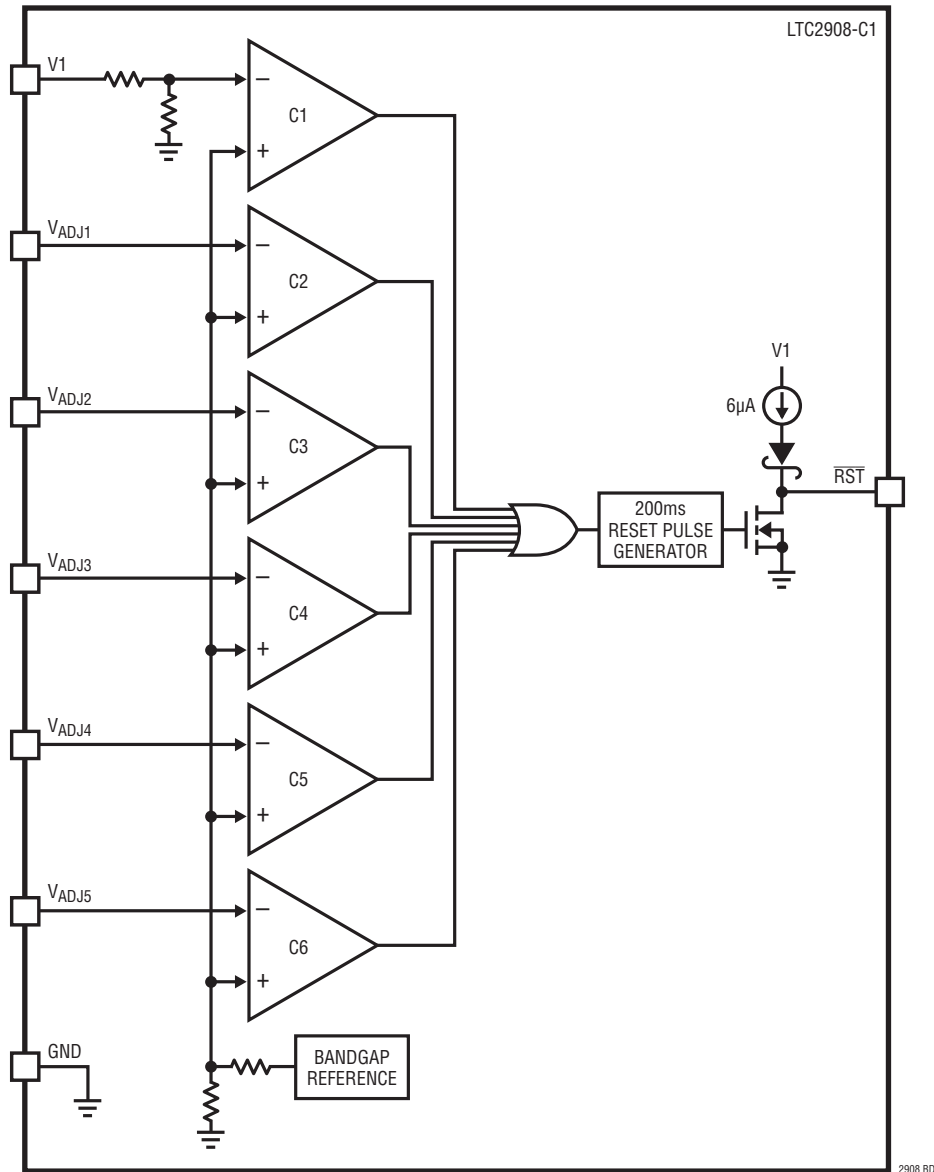

TIMING DIAGRAM

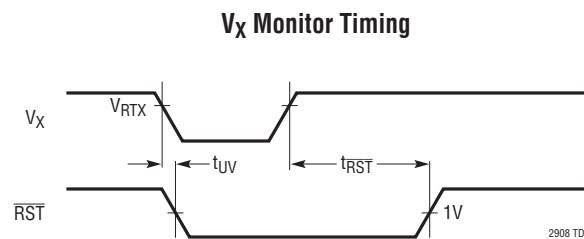

LTC2908

APPLICATIONS INFORMATION

Supply Monitoring

The LTC2908 is a low power, high accuracy, six input supply monitoring circuit with two adjustable inputs. The reset delay is set to a nominal of 200ms with an internal capacitor, eliminating the need for an external timing capacitor.

All input voltages must be above predetermined thresholds for the reset not to be invoked. The LTC2908 asserts the reset output during power-up, power-down and brownout conditions on any one of the voltage inputs.

Ultralow Voltage Pull-Down on $\overline{\text{RST}}$

The LTC2908 issues a logic low on the $\overline{\text{RST}}$ output when any one of the inputs falls below its threshold. Ideally, the $\overline{\text{RST}}$ logic output would remain low with the input supply voltage down to zero volts. Most supervisors lack pull-down capability below 1V.

The LTC2908 power supply supervisor incorporates a novel low voltage pull-down circuit that can hold the $\overline{\text{RST}}$ line low with as little as 200mV of input supply voltage on V1 and/or V2 (see Figures 1 and 2). The pull-down circuit helps maintain a low impedance path to ground, reducing the risk of the $\overline{\text{RST}}$ node from floating to an indeterminate voltage.

Such an indeterminate voltage may trigger external logic causing erroneous reset operation(s). Furthermore, a mid-scale voltage level could cause external circuits to operate in the middle of their voltage transfer characteristic, consuming more quiescent current than normal. These conditions could cause serious system reliability problems.

Power-Up

During power-up, $\overline{\text{RST}}$ starts asserting low as soon as there is at least 200mV on V1 and/or V2. The $\overline{\text{RST}}$ pull-down capability is a function of V1 and V2 as shown in the Typical Performance Characteristics.

The greater of V1, V2 is the internal supply voltage (V_{CC}) that powers the other internal circuitry. Once all the V_X inputs rise above their thresholds, an internal timer is started. After the internal timer counts a 200ms delay time, $\overline{\text{RST}}$ weakly pulls high to V_{CC} .

Power-Down

On power-down, once any of the V_X inputs drop below their threshold, $\overline{\text{RST}}$ asserts logic low. V_{CC} of at least 0.5V guarantees a logic low of 0.15V at $\overline{\text{RST}}$.

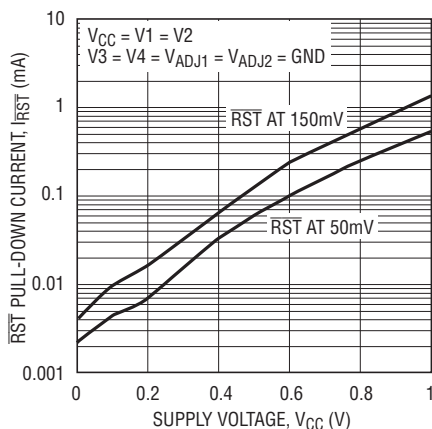

Figure 1. $\overline{\text{RST}}$ Pull-Down Current vs Supply Voltage with 2 Inputs LTC2908-A1/ LTC2908-B1

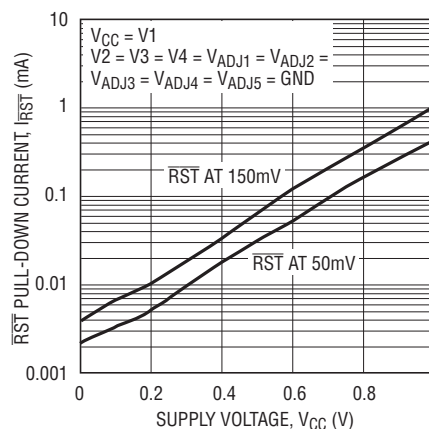

Figure 2. $\overline{\text{RST}}$ Pull-Down Current vs Supply Voltage with 1 Input

APPLICATIONS INFORMATION

Adjustable Input

The noninverting input on the V_{ADJ} comparator is set to 0.5V. And the high impedance inverting input directly ties to the V_{ADJ} pin.

In a typical application, this pin connects to a tap point on an external resistive divider between the positive voltage being monitored and ground (see Figure 3). The following formula derives the value of the R1 resistor in the divider from a particular value of R2 and the desired trip voltage:

$$R1 = \left(\frac{V_{TRIP}}{0.5V} - 1 \right) R2$$

R2 = 100k is recommended. Table 1 shows suggested 1% resistor values for various adjustable applications and their corresponding trip thresholds.

Table 1. Suggested 1% Resistor Values for the V_{ADJ} Inputs

V_{SUPPLY} (V)	V_{TRIP} (V)	R1 (k Ω)	R2 (k Ω)
12	11.25	2150	100
10	9.4	1780	100
8	7.5	1400	100
7.5	7	1300	100
6	5.6	1020	100
5	4.725	845	100
3.3	3.055	511	100
3	2.82	464	100
2.5	2.325	365	100
1.8	1.685	237	100
1.5	1.410	182	100
1.2	1.120	124	100
1.0	0.933	86.6	100
0.9	0.840	68.1	100
0.8	0.750	49.9	100
0.7	0.655	30.9	100
0.6	0.561	12.1	100

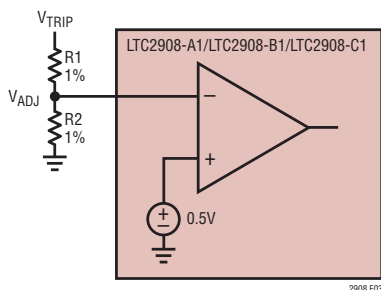

Figure 3. Setting the Adjustable Trip Point

In an application with less than six supply voltages, the unused supervisor inputs should be tied to the closest higher supply voltage available.

Threshold Accuracy

Specifying system voltage margin for worst-case operation requires the consideration of three factors: power supply tolerance, IC supply voltage tolerance and supervisor reset threshold accuracy. Highly accurate supervisors ease the design challenge by decreasing the overall voltage margin required for reliable system operation.

Consider a 5V system with a $\pm 5\%$ power supply tolerance band. System ICs powered by this supply must operate reliably within this band (and a little more, as explained below). The bottom of the supply tolerance band, at 4.75V (5% below 5V), is the exact voltage at which a perfectly accurate supervisor generates a reset (see Figure 4). Such a perfectly accurate supervisor does not exist—the actual reset threshold may vary over a specified band ($\pm 1.5\%$ for the LTC2908 supervisors). Figure 5 shows the typical relative threshold accuracy for all six inputs overtemperature.

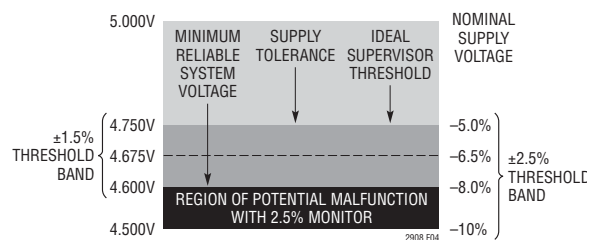

Figure 4. Threshold Band Diagram

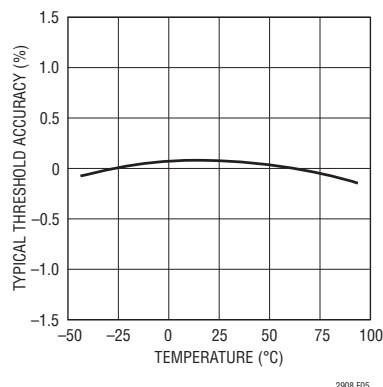

Figure 5. Typical Threshold Accuracy vs Temperature

LTC2908

APPLICATIONS INFORMATION

With this variation of reset threshold in mind, the nominal reset threshold of the supervisor resides below the minimum supply voltage; just enough so that the reset threshold band and the power supply tolerance bands do not overlap. If the two bands overlap, the supervisor could generate a false or nuisance reset when the power supply remains within its specified tolerance band (for example at 4.8V).

Adding half of the reset threshold accuracy spread (1.5%) to the ideal 5% thresholds puts the LTC2908 thresholds at 6.5% (typ) below the nominal input voltage. For example, the 5V typical threshold is 4.675V, or 75mV below the ideal threshold of 4.750V. The guaranteed threshold lies in the band between 4.600V (8% below 5V) and 4.750V (5% below 5V) overtemperature.

The powered system must work reliably down to the lowest voltage in the threshold band or risk malfunction before the reset line falls. In the 5V example, using the 1.5% accurate supervisor, the system ICs must work down to 4.60V (8% below 5V). System ICs working with a $\pm 2.5\%$ accurate supervisor must operate down to 4.50V (10% below 5V), increasing the required system voltage margin and the probability of system malfunction.

In any supervisory application, supply noise riding on the monitored DC voltage can cause spurious resets, particularly when the monitored voltage is near the reset threshold. A less desirable but common solution to this problem is to introduce hysteresis around the nominal threshold. Notice however, this hysteresis introduces an error term in the threshold accuracy. Therefore, a $\pm 2.5\%$ accurate monitor with $\pm 1\%$ hysteresis is equivalent to a $\pm 3.5\%$ monitor with no hysteresis.

Therefore, the LTC2908 takes a different approach to solving this problem of supply noise causing spurious reset. The first line of defense against this spurious reset is a first order lowpass filter at the output of the comparators. Therefore, each comparator output is integrated over time before triggering the output logic. Therefore, any kind of transient at the input of the comparator needs to be of sufficient magnitude and duration before it can trigger a change in the output logic.

The second line of defense is the 200ms delay time $t_{\overline{RST}}$. This delay eliminates the effect of any supply noise, whose frequency is above $1/200\text{ms} = 5\text{Hz}$, on the \overline{RST} output.

When any one of the supply voltages drops below its threshold, the \overline{RST} pin asserts low. When the supply recovers above its threshold, the reset-pulse-generator timer starts counting.

If all the supplies remain above their corresponding threshold when the timer finishes counting, the \overline{RST} pin weakly pulls high. However, if any of the supplies falls below its threshold any time during the period when the timer is still counting, the timer resets and it starts fresh when all the supplies rise above their corresponding threshold.

Note that this second line of defense is only effective for a rising supply and does not affect the sensitivity of the system to a falling supply. Therefore, the first line of defense that works for both cases of rising and falling is necessary. These two approaches prevent spurious reset caused by supply noise without sacrificing the threshold accuracy.

Although all six comparators for the six inputs have built-in glitch filtering, use bypass capacitors on the V1 and V2 inputs because the greater of V1 or V2 supplies the V_{CC} for the part (a 0.1 μF ceramic capacitor satisfies most applications). Apply filter capacitors on the V3, V4, V_{ADJ1} , V_{ADJ2} , V_{ADJ3} , V_{ADJ4} and V_{ADJ5} inputs in extremely noisy situations.

APPLICATIONS INFORMATION

$\overline{\text{RST}}$ Output Characteristics

The DC characteristics of the $\overline{\text{RST}}$ pull-up and pull-down strength are shown in the Typical Performance Characteristics section. The $\overline{\text{RST}}$ output has a weak internal pull-up to $V_{\text{CC}} = \text{Max}(V1, V2)$ and a strong pull-down to ground.

The weak pull-up and strong pull-down arrangement allows this pin to have open-drain behavior while possessing several other beneficial characteristics.

The weak pull-up eliminates the need for external pull-up resistors when the rise time on these pins is not critical. On the other hand, the open-drain $\overline{\text{RST}}$ behavior allows for wired-OR connections and can be useful when more than one signal needs to pull down on the $\overline{\text{RST}}$ line.

As noted in the discussion of power-up and power-down, the circuits that drive $\overline{\text{RST}}$ are powered by V_{CC} . During a fault condition, a V_{CC} of at least 0.5V guarantees a maximum $V_{\text{OL}} = 0.15\text{V}$ at $\overline{\text{RST}}$.

Output Rise and Fall Time Estimation

The following formula estimates the output fall time (90% to 10%) for a particular external load capacitance (C_{LOAD}):

$$t_{\text{FALL}} \approx 2.2 \cdot R_{\text{PD}} \cdot C_{\text{LOAD}}$$

where R_{PD} is the on-resistance of the internal pull-

down transistor estimated to be typically 40Ω at room temperature (25°C) and C_{LOAD} is the external load capacitance on the pin. Assuming a 150pF load capacitance, the fall time is about 13ns .

The rise time on the $\overline{\text{RST}}$ pin is limited by a weak internal pull-up current source to V_{CC} . The following formula estimates the output rise time (10% to 90%) at the $\overline{\text{RST}}$ pin:

$$t_{\text{RISE}} \approx 2.2 \cdot R_{\text{PU}} \cdot C_{\text{LOAD}}$$

where R_{PU} is the on-resistance of the pull-up transistor. Notice that this pull-up transistor is modeled as a $6\mu\text{A}$ current source in the Block Diagram as a typical representation.

The on-resistance as a function of the $V_{\text{CC}} = \text{Max}(V1, V2)$ voltage (for $V_{\text{CC}} > 1\text{V}$) at room temperature is estimated as follows:

$$R_{\text{PU}} = \frac{6 \cdot 10^5}{\text{MAX}(V1, V2) - 1\text{V}} \Omega$$

At $V_{\text{CC}} = 3.3\text{V}$, R_{PU} is about 260k . Using 150pF for load capacitance, the rise time is $86\mu\text{s}$. A smaller external pull-up resistor may be used if the output needs to pull up faster and/or to a higher voltage. For example, the rise time reduces to $3.3\mu\text{s}$ for a 150pF load capacitance when using a 10k pull-up resistor.

TYPICAL APPLICATIONS

Six Supply Monitor, 5% Tolerance, 12V, 5V, 3.3V, 2.5V, 1.8V, 1V

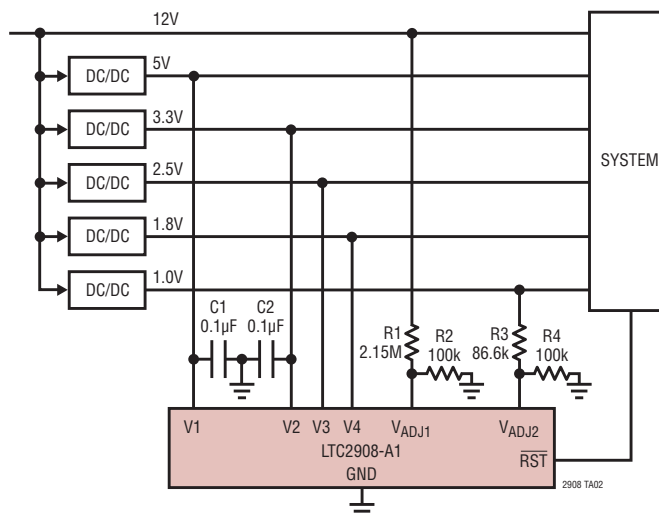

2908fd

LTC2908

TYPICAL APPLICATIONS

Quad Supply Monitor with One Adjustable Input, 5% Tolerance, 3.3V, 2.5V, 1.8V, 1.2V

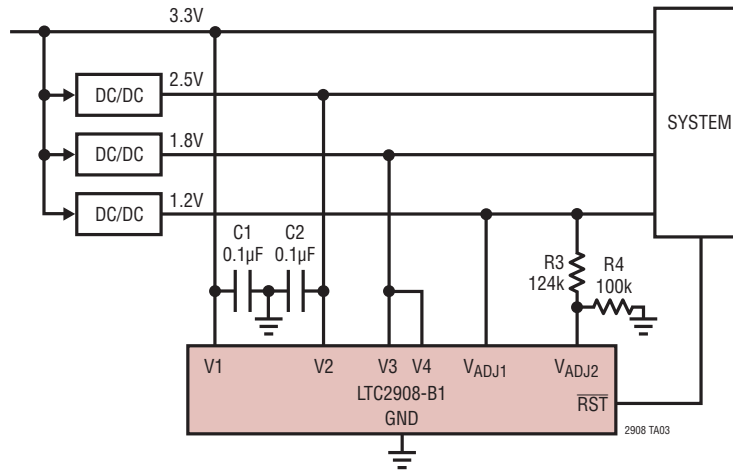

Pin Programmable Dual Supply Monitor with Possible Future Expansion up to Six Supplies, 5% Tolerance, 3.3V and 2.5V

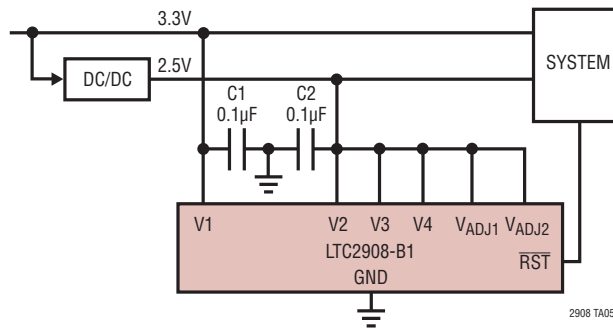

Six Supply Monitor, 5% Tolerance 12V, 2.5V, 1.8V, 1.5V, 1.2V, 1.0V

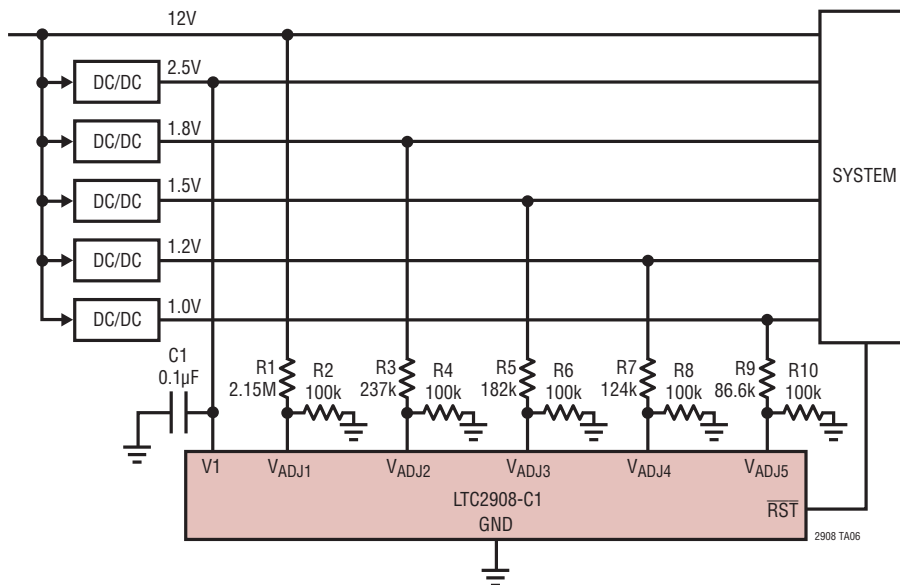

2908fd

LTC2908

PACKAGE DESCRIPTION

TS8 Package
8-Lead Plastic TSOT-23
 (Reference LTC DWG # 05-08-1637)

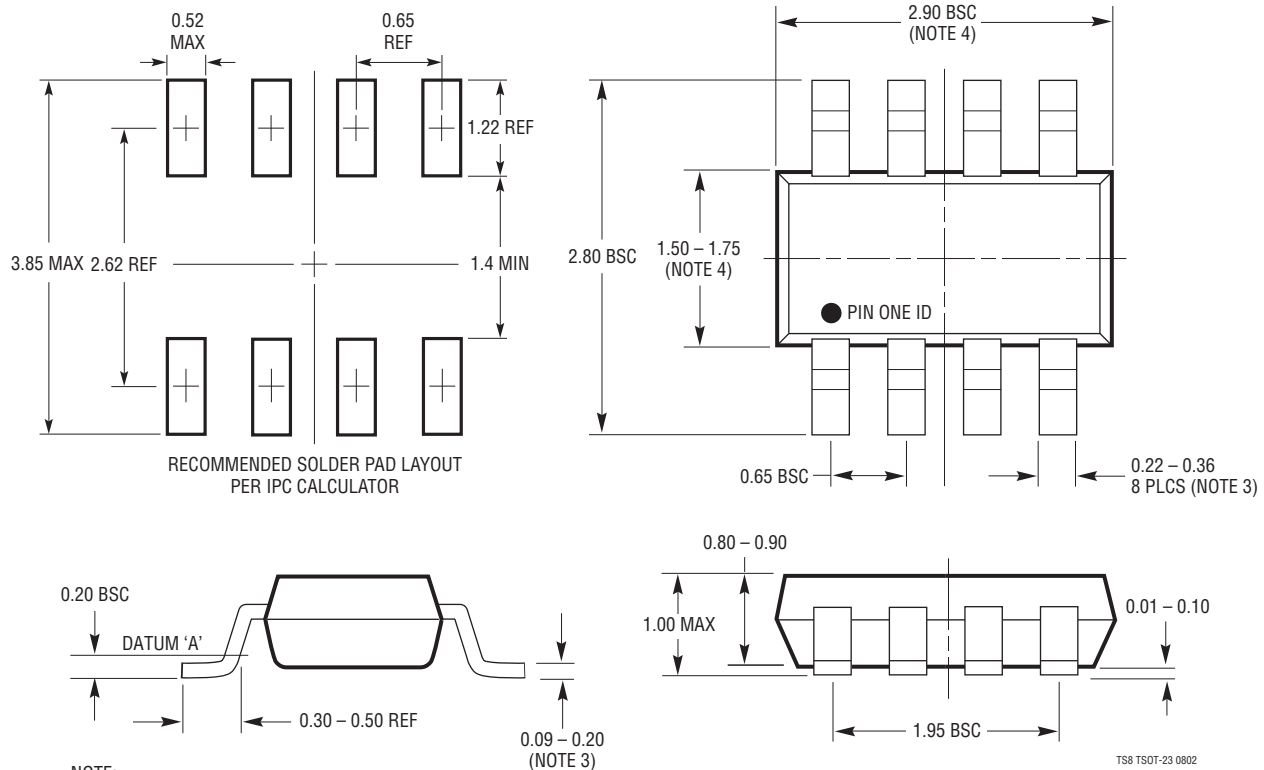

REVISION HISTORY (Revision history begins at Rev D)

REV	DATE	DESCRIPTION	PAGE NUMBER
D	01/10	Revised Tape and Reel Part Numbers	2

LTC2908

TYPICAL APPLICATION

Six Supply Monitor with Manual Reset Button, 5% Tolerance, 12V, 5V, 3.3V, 2.5V, 1.8V, 1.5V

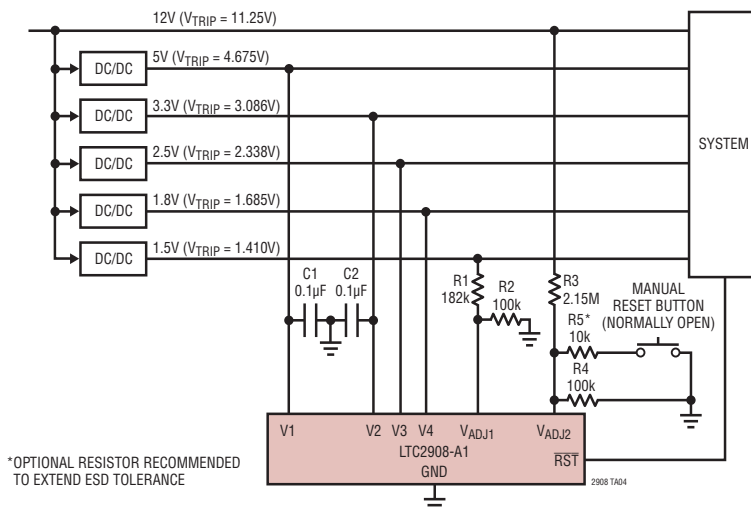

RELATED PARTS

PART NUMBER	DESCRIPTION	COMMENTS
LTC690	5V Supply Monitor, Watchdog Timer and Battery Backup	4.65 Threshold
LTC694-3.3	3.3V Supply Monitor, Watchdog Timer and Battery Backup	2.9V Threshold
LTC699	5V Supply Monitor and Watchdog Timer	4.65 Threshold
LTC1232	5V Supply Monitor, Watchdog Timer and Pushbutton Reset	4.37V/4.62V Threshold
LTC1326/LTC1326-2.5	Micropower Precision Triple Supply Monitor for 5V/2.5V, 3.3V and ADJ	4.725V, 3.118V, 1V Threshold ($\pm 0.75\%$) and ADJ
LTC1536	Precision Triple Supply Monitor for PCI Applications	Meets PCI t_{FAIL} Timing Specifications
LTC1726-2.5/LTC1726-5	Micropower Triple Supply Monitor for 2.5V/5V, 3.3V and ADJ	Adjustable Reset and Watchdog Time-Outs
LTC1727-2.5/LTC1727-5	Micropower Triple Supply Monitor with Open-Drain Reset	Individual Monitor Outputs in MSOP
LTC1728-1.8/LTC1728-3.3	Micropower Triple Supply Monitor with Open-Drain Reset	5-Lead SOT-23 Package
LTC1728-2.5/LTC1728-5	Micropower Triple Supply Monitor with Open-Drain Reset	5-Lead SOT-23 Package
LTC1985-1.8	Micropower Triple Supply Monitor with Push-Pull Reset Output	5-Lead SOT-23 Package
LTC2900	Programmable Quad Supply Monitor	Adjustable Reset, 10-Lead MSOP and DFN Packages
LTC2901	Programmable Quad Supply Monitor	Adjustable Reset and Watchdog Timer, 16-Lead SSOP Package
LTC2902	Programmable Quad Supply Monitor	Adjustable Reset and Tolerance, 16-Lead SSOP Package
LTC2903	Precision Quad Supply Monitor	6-Lead SOT-23 Package
LTC2904	Three-State Programmable Precision Dual Supply Monitor	Adjustable Tolerance, 8-Lead SOT-23 and DFN Packages
LTC2905	Three-State Programmable Precision Dual Supply Monitor	Adjustable Reset and Tolerance, 8-Lead SOT-23 and DFN Packages
LTC2906	Dual Supply Monitor with One Pin Selectable Threshold and One Adjustable Input	0.5V Adjustable Threshold and Three Supply Tolerances, 8-Lead SOT-23 and DFN Packages
LTC2907	Dual Supply Monitor with One Pin Selectable Threshold and One Adjustable Input	0.5V Adjustable Threshold, Reset and Three Supply Tolerances, 8-Lead SOT-23 and DFN Packages
LTC2909	Precision Triple/Dual Input UV, OV and Negative Voltage Monitor	Shunt Regulated V_{CC} Pin, Adjustable Threshold and Reset, 8-Lead SOT-23 and DFN Packages

2908fd

OUR CERTIFICATE

DiGi provide top-quality products and perfect service for customer worldwide through standardization, technological innovation and continuous improvement. DiGi through third-party certification, we stricly control the quality of products and services. Welcome your RFQ to

Email: Info@DiGi-Electronics.com



Tel: +00 852-30501935

RFQ Email: Info@DiGi-Electronics.com

DiGi is a global authorized distributor of electronic components.