

MAX11502USA+ Datasheet

www.digi-electronics.com

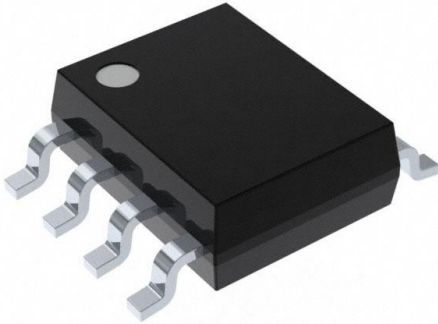

<https://www.DiGi-Electronics.com>

DiGi Electronics Part Number	MAX11502USA+-DG
Manufacturer	Analog Devices Inc./Maxim Integrated
Manufacturer Product Number	MAX11502USA+
Description	IC VIDEO FILTER 8SOIC
Detailed Description	Video Filter IC NTSC 8-SOIC Package



Tel: +00 852-30501935

RFQ Email: Info@DiGi-Electronics.com

DiGi is a global authorized distributor of electronic components.

Purchase and inquiry

Manufacturer Product Number:

MAX11502USA+

Series:

-

Function:

Filter

Standards:

NTSC

Mounting Type:

Surface Mount

Supplier Device Package:

8-SOIC

Manufacturer:

Analog Devices Inc./Maxim Integrated

Product Status:

Obsolete

Applications:

Consumer Video

Voltage - Supply:

4.75V ~ 5.25V

Package / Case:

8-SOIC (0.154", 3.90mm Width)

Base Product Number:

MAX11502

Environmental & Export classification

RoHS Status:

ROHS3 Compliant

REACH Status:

REACH Unaffected

HTSUS:

8542.39.0001

Moisture Sensitivity Level (MSL):

1 (Unlimited)

ECCN:

EAR99

EVALUATION KIT
AVAILABLE

Three-Channel, Standard-Definition Video Filters

General Description

The MAX11501/MAX11502 integrated filters offer three channels of 5th-order filters for standard-definition video and include +6dB output buffers on each channel. These video filters are ideal for anti-aliasing and DAC smoothing in applications such as set-top boxes, security systems, digital video recorders (DVRs), DVD players, and personal video recorders.

The MAX11501/MAX11502 video inputs feature a transparent clamp compatible with AC- and DC-coupled input signals and allow DAC outputs to be directly coupled. The 5th-order filters provide a typical -3dB bandwidth of 8.6MHz (MAX11501) and 8.9MHz (MAX11502) and offer either a flat passband response (MAX11501) or a +0.8dB peaking passband response (MAX11502) on all channels.

Each channel includes an output buffer with a gain of +6dB capable of driving a full 2V_{P-P} video signal into two standard 150Ω (75Ω back-terminated) video loads. The buffers drive either AC- or DC-coupled loads and assure a blanking level of below 1V after the back-match resistor.

The MAX11501/MAX11502 operate from a single +5V supply and are available in the upper commercial 0°C to +85°C temperature range. These devices are available in small 8-pin SO packages.

Applications

Set-Top Box Receivers
Digital Video Recorders (DVRs)
Security Video Systems
SDTV
DVD Players
Personal Video Recorders
Video On-Demand

Typical Operating Circuit and Pin Configuration appear at end of data sheet.

Features

- ◆ Three-Channel 5th-Order 9MHz Filter for Standard-Definition Video
- ◆ +6dB Output Buffers
- ◆ Transparent Input Clamp
- ◆ AC- or DC-Coupled Inputs
- ◆ AC- or DC-Coupled Outputs
- ◆ Flat Passband Response (MAX11501)
- ◆ +0.8dB Peaking Passband Response (MAX11502) on All Channels
- ◆ 12kV HBM ESD Protection on Outputs
- ◆ Single +5V Power Supply
- ◆ Small 8-Pin SO Package

Ordering Information

PART	PIN-PACKAGE	FREQUENCY RESPONSE
MAX11501USA+	8 SO	Flat
MAX11502USA+	8 SO	HF Boost

+Denotes a lead-free package.

Note: All devices are specified over the 0°C to +85°C operating temperature range.

Block Diagram

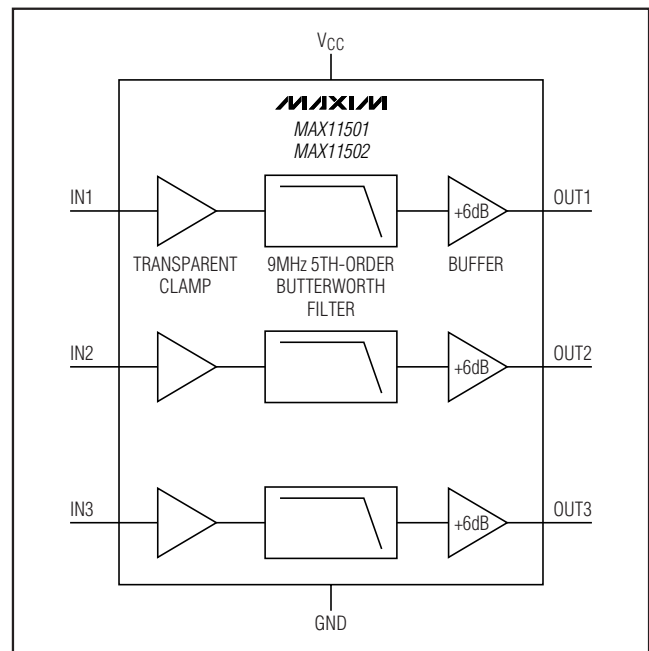

MAX11501/MAX11502

Three-Channel, Standard-Definition Video Filters

MAX11501/MAX11502

ABSOLUTE MAXIMUM RATINGS

V_{CC} to GND-0.3V to +6V
 All other pins to GND ...-0.3V to the lower of (V_{CC} + 0.3V) and +6V
 Continuous Power Dissipation (T_A = +70°C)
 8-Pin SO (derate 5.9mW/°C above +70°C)..... 470mW
 Maximum Current into any Pin Except V_{CC} and GND.....±50mA

Operating Temperature Range
 MAX1150_USA+0°C to +85°C
 Storage Temperature Range-65°C to +150°C
 Lead temperature (soldering, 10s)+300°C
 Junction Temperature+150°C

Stresses beyond those listed under "Absolute Maximum Ratings" may cause permanent damage to the device. These are stress ratings only, and functional operation of the device at these or any other conditions beyond those indicated in the operational sections of the specifications is not implied. Exposure to absolute maximum rating conditions for extended periods may affect device reliability.

ELECTRICAL CHARACTERISTICS

(V_{CC} = +5V, R_{LOAD} = 150Ω to GND, C_{IN} = 0.1μF, T_A = 0°C to +85°C, frequency response is relative to 100kHz, unless otherwise noted.)

PARAMETER	SYMBOL	CONDITIONS	MIN	TYP	MAX	UNITS
-1dB Bandwidth	f _{1dB}	MAX11501	4.5	7.2		MHz
		MAX11502	5	7.8		
-3dB Bandwidth	f _{3dB}	MAX11501		8.6		MHz
		MAX11502		8.9		
Stopband Attenuation	A _{SB}	MAX11501, f = 27MHz		50		dB
		MAX11502, f = 27MHz		48		
Low-Frequency Gain	A _V		5.8	6.0	6.2	dB
Low-Frequency Gain Match	A _V (MATCH)			0.02		dB
Input Voltage Range	V _{IN}	Referenced to GND if DC-coupled		1.4		V
Differential Gain	dG	All channels		0.1		%
Differential Phase	dφ	All channels		0.3		Degrees
Total Harmonic Distortion	THD	V _{OUT} = 1.8V _{P-P} , f = 1MHz (all channels)		0.1		%
Channel-to-Channel Crosstalk	X _{TALK}	f = 1MHz		-80		dB
Signal-to-Noise Ratio	SNR	NTC-7 weighting, 100kHz, 4.2MHz		80		dB
Propagation Delay	t _{PD}	f = 4.5MHz		76		ns
Supply Voltage Range	V _{DD}		4.75	5	5.25	V
Supply Current	I _{CC}	No load		18	26	mA
Power-Supply Rejection Ratio	PSRR	DC (all channels)		60		dB

Three-Channel, Standard-Definition Video Filters

Typical Operating Characteristics

($V_{CC} = 5V$, $R_L = 150\Omega$ to GND, output DC-coupled, $T_A = +25^\circ C$.)

MAX11501/MAX11502

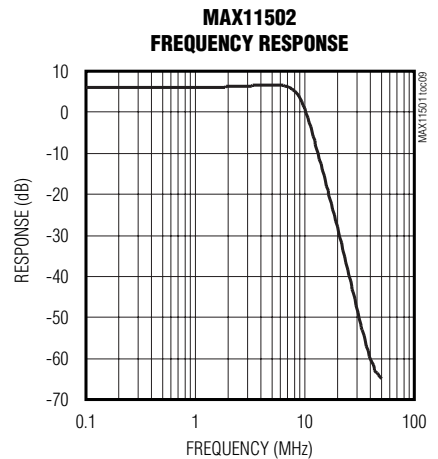
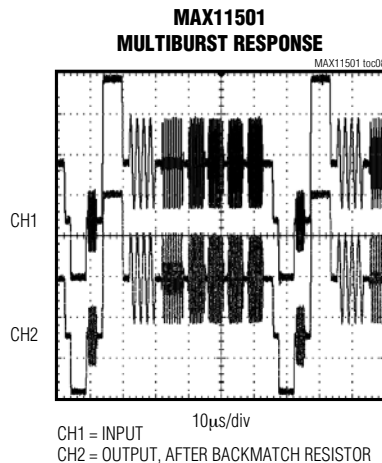
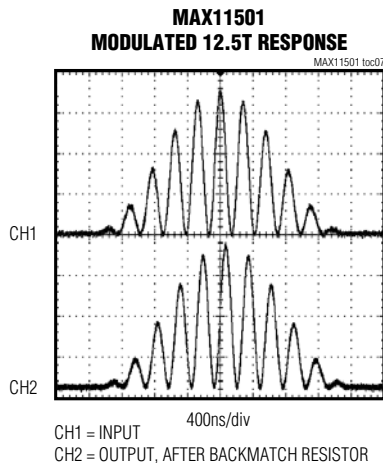
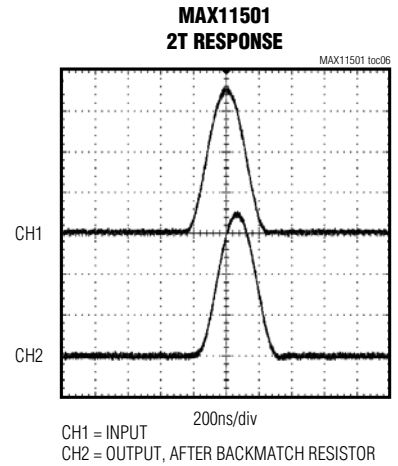
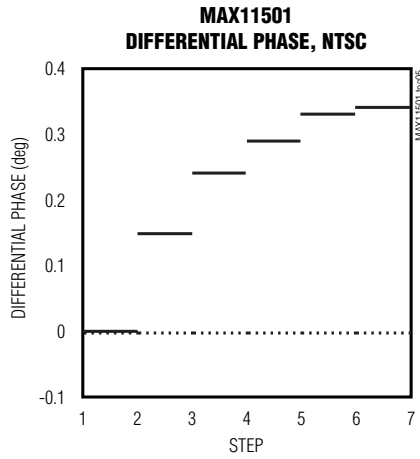
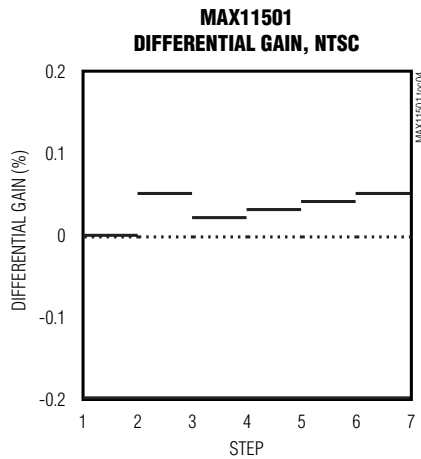
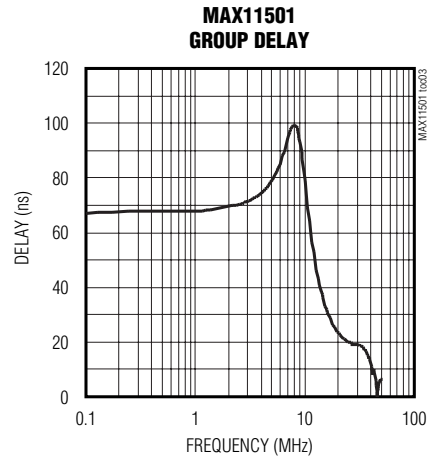
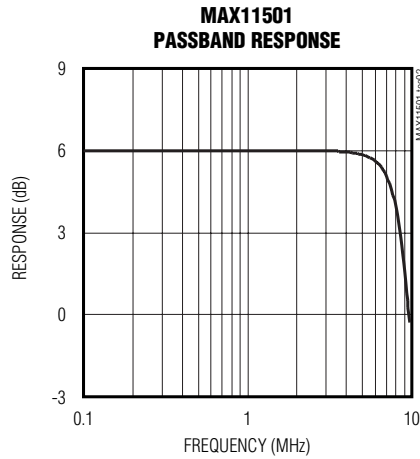
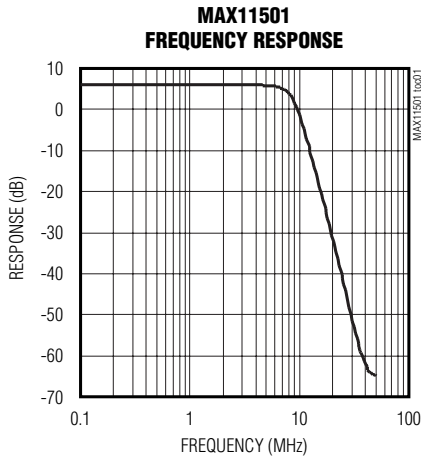

Three-Channel, Standard-Definition Video Filters

Typical Operating Characteristics (continued)

($V_{CC} = 5V$, $R_L = 150\Omega$ to GND, output DC-coupled, $T_A = +25^\circ C$.)

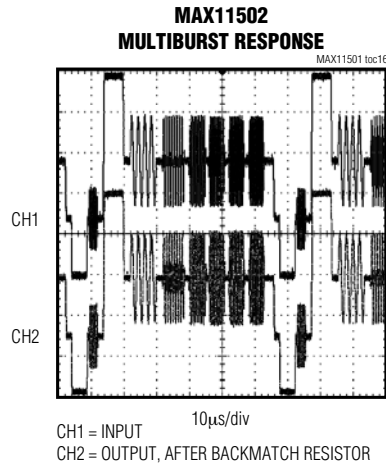
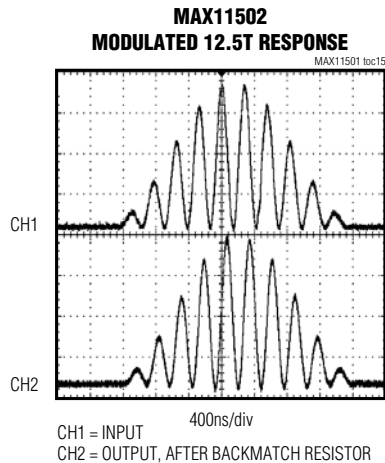
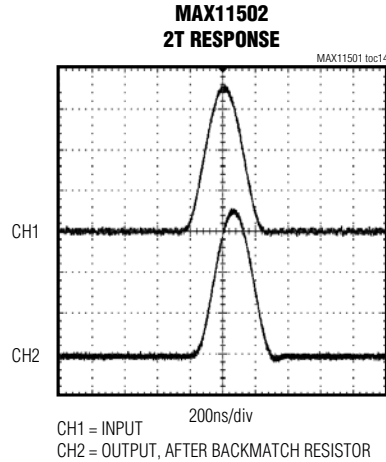
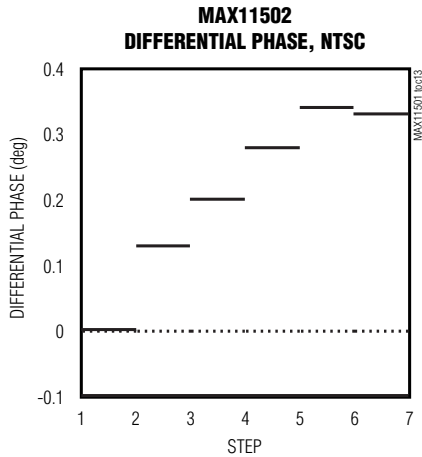
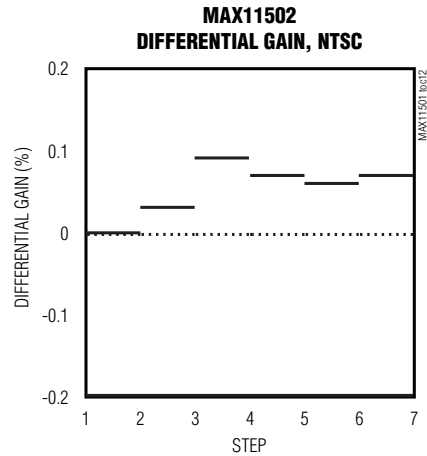
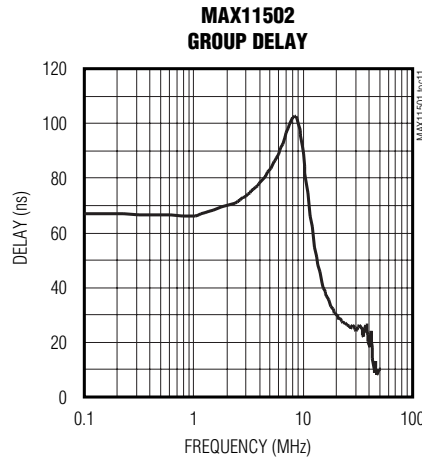
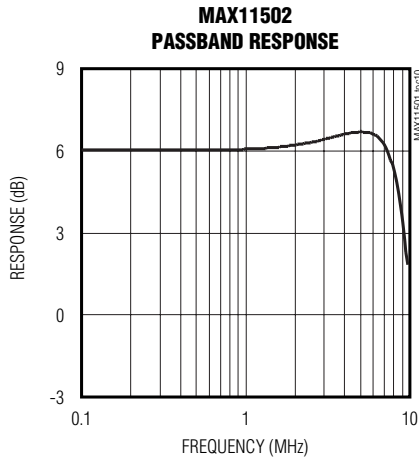

Three-Channel, Standard-Definition Video Filters

Pin Description

PIN	NAME	FUNCTION
1	IN1	Video Input Channel 1
2	IN2	Video Input Channel 2
3	IN3	Video Input Channel 3
4	V _{CC}	Power Supply
5	GND	Ground
6	OUT3	Video Output Channel 3
7	OUT2	Video Output Channel 2
8	OUT1	Video Output Channel 1

Detailed Description

Each channel of the MAX11501/MAX11502 contains a transparent input clamp, an 8.6MHz (MAX11501) or 8.9MHz (MAX11502), 5th-order lowpass filter and an

output amplifier with a gain of two (see the *Typical Operating Circuit*). The MAX11501 provides a flat pass-band response and the MAX11502 features a +0.8dB high-frequency boost at 5MHz on all channels to help with system roll-off. Within the passband, each channel amplifies the signal by two and adds 280mV of offset.

$$V_{OUT} = (2 \times V_{IN}) + 0.28V$$

Typical voltage levels are shown in Figures 1 and 2.

Inputs

Transparent Clamps

All inputs feature transparent clamps to allow either AC or DC input coupling. The clamp remains inactive while the input signal is above ground, offering true DC input coupling. If the signal goes below ground, as when the signal is AC-coupled, the internal clamp sets the sync tip at slightly below the ground level.

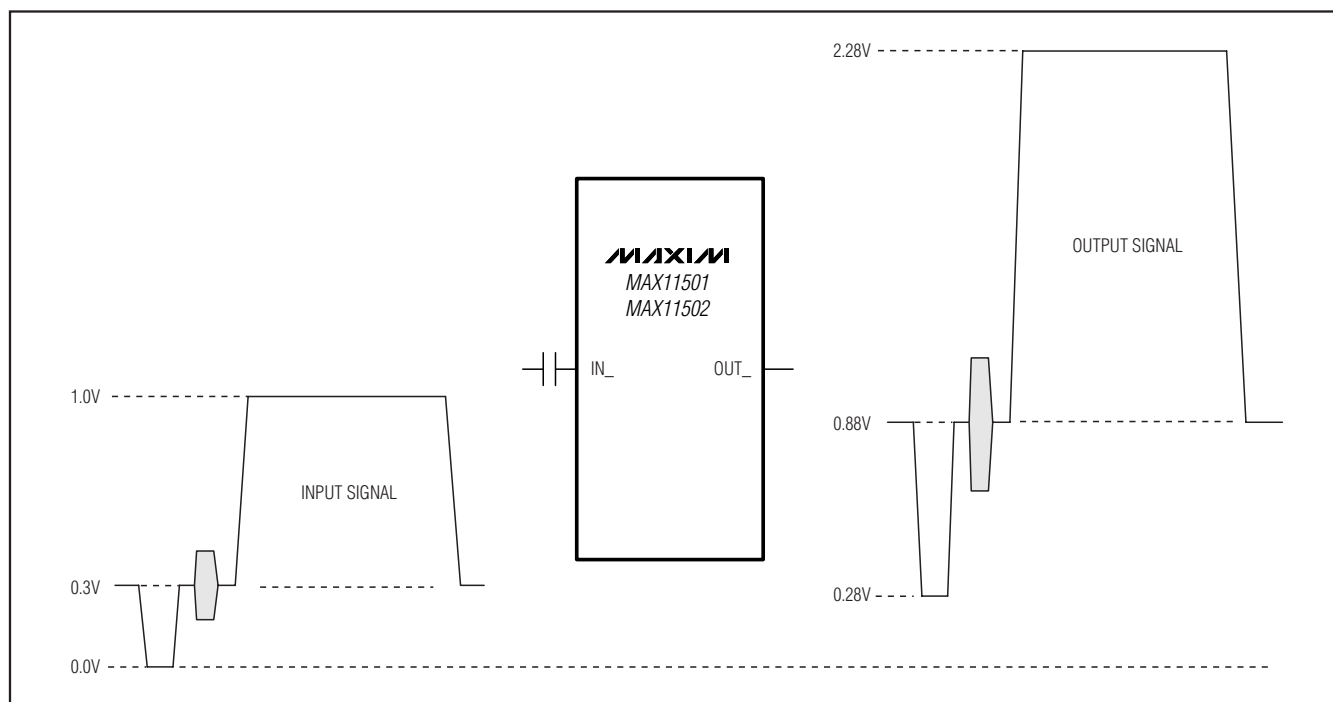

Figure 1. Typical AC-Coupled Signal

Three-Channel, Standard-Definition Video Filters

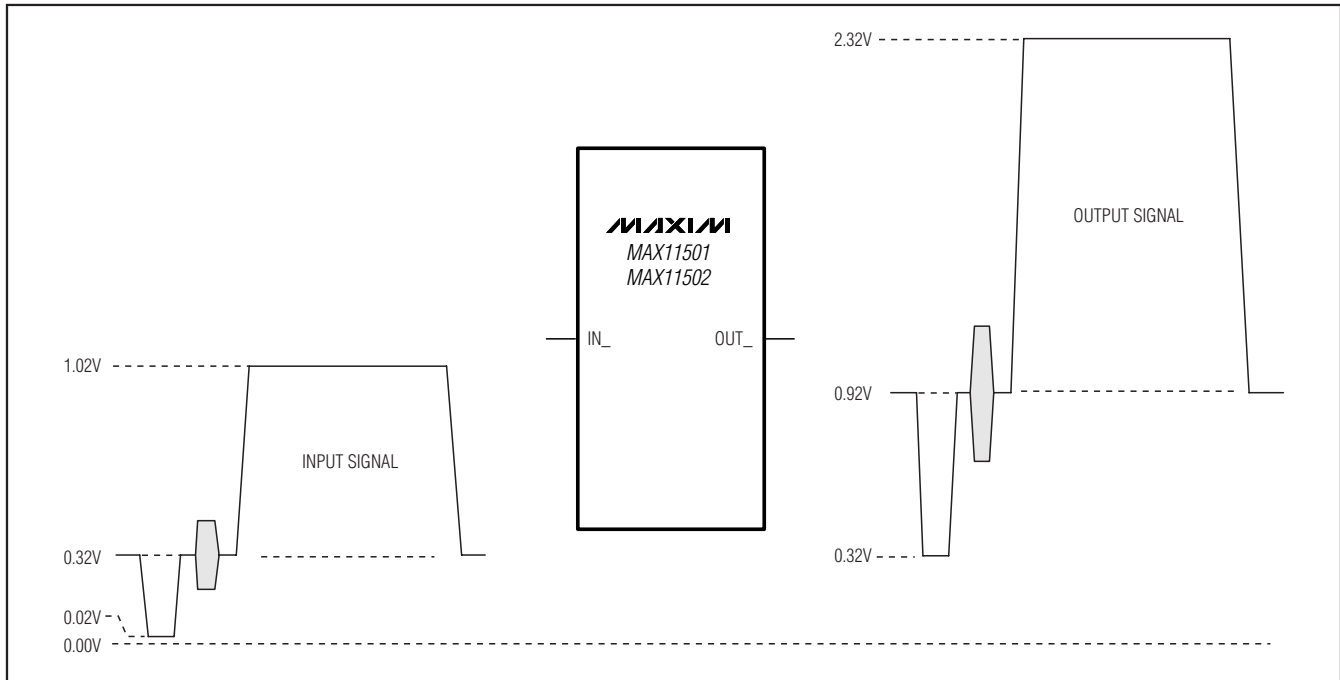

Figure 2. Typical DC-Coupled Signal

Input Coupling

The choice of AC- or DC-coupling the input depends on the video source. Many DACs provide a current output and are terminated to ground with a resistor. Such DAC outputs are conveniently DC-coupled to the MAX11501/MAX11502. Use AC-coupling when the DC level of the video signal is unknown or outside the specified input range of the MAX11501/MAX11502, such as SCART or V_{CC} terminated DAC outputs.

DC-Coupled Inputs

If the input is DC-coupled, the input voltage must remain above zero but not exceed the maximum input voltage of 1.4V (typical).

AC-Coupled Inputs

If the input is AC-coupled, the transparent clamps are active and set the lowest point of the signal at ground. This is appropriate for unipolar signals such as Y, R, G, or B, with or without sync pulses (Figure 3).

For bipolar signals such as Pb and Pr, bias the AC-coupled inputs to a fixed DC voltage, typically 0.59V, to ensure that the transparent clamp remains off. A suitable network is shown in Figure 4. Determine the bias voltage using:

$$V_B = \frac{R_2}{R_1 + R_2} \times (V_{CC} - (I_L \times R_1)),$$

where I_L is the input leakage current (typically 0.5 μ A).

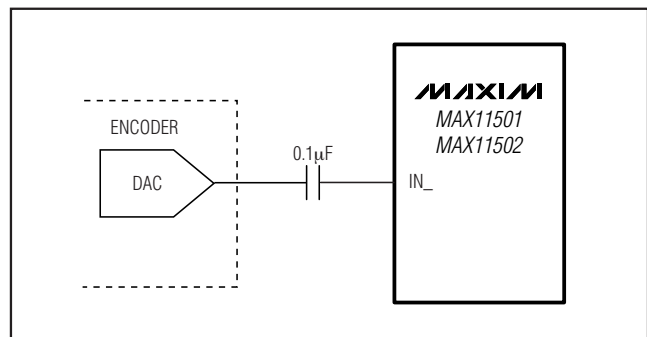

Figure 3. Simple AC-Coupling for Unipolar Signals (Y, R, G, B)

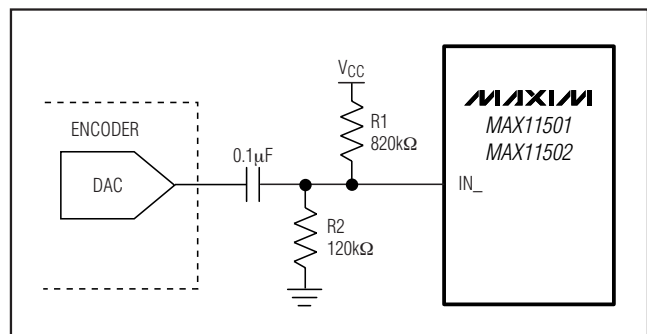

Figure 4. AC-Coupling for Bipolar Signals (Pb, Pr)

Three-Channel, Standard-Definition Video Filters

Standard-Definition Filters

The MAX11501/MAX11502 filters are optimized to deliver a flat (MAX11501) or high-frequency boosted (MAX11502) passband and high stopband attenuation. The filter characteristics have been chosen to provide excellent time domain response with low overshoot. The typical -3dB frequency of 8.6MHz (MAX11501) and 8.9MHz (MAX11502) guarantee minimal attenuation in the passband while at the same time offering a 27MHz attenuation of typically -50dB (MAX11501) and -48dB (MAX11502).

Output Buffer

The MAX11501/MAX11502 feature output buffers with +6dB of gain. A typical load (Figure 5(a)) is a 75Ω back-match resistor, an optional 220μF or larger AC-coupling capacitor, a transmission line, and a 75Ω termination resistor. The MAX11501/MAX11502 clamp the signal, forcing the blanking level to less than 1V at the termination resistor. This allows direct drive of video loads at digital TV specifications without the need for costly AC-coupling capacitors. The MAX11501/MAX11502 drive two parallel loads per output (Figure 5(b)), but thermal considerations must be taken into account when doing so (see the *Junction-Temperature Calculations* section).

Applications Information

Output Configuration

The MAX11501/MAX11502 outputs may be either DC- or AC-coupled. When the outputs are AC-coupled, choose a capacitor that passes the lowest frequency content of the video signal, and keeps the line-time distortion within desired limits. The capacitor value is a function of the input leakage and impedance of the circuit being driven. The MAX11501/MAX11502 easily drive the industry common 220μF, or larger, coupling capacitor. If any or all outputs are driving two parallel loads, see the *Junction-Temperature Calculations* section.

The MAX11501/MAX11502 outputs are fully protected against short circuits to ground. The short-circuit protection circuitry limits the output current to 80mA (typical) per output. Shorting more than one output to ground simultaneously may exceed the maximum package power dissipation.

Junction-Temperature Calculations

Die temperature is a function of quiescent power dissipation and the power dissipation in the output drivers. Calculate the power dissipated, P_D , using:

$$P_D = P_{DS} + P_{DO1} + P_{DO2} + P_{DO3}$$

where P_{DS} is the quiescent power dissipated in the die, and given by:

$$P_{DS} = V_{CC} \times I_{CC}$$

and where P_{DO_n} is the power dissipated in the nth driver stage and given by:

$$P_{DO_n} = \frac{(V_{CC} - V_{ORMSn}) \times V_{ORMSn}}{R_{Ln}}$$

where V_{ORMSn} is the RMS output voltage and R_{Ln} is the load resistance.

The following is an example of a junction-temperature calculation, assuming the following conditions:

- 1) Video standard = 525/60/2:1.
- 2) Video format = RGB with syncs on all.
- 3) Picture content = 100% white.
- 4) The input signal is AC-coupled.
- 5) The output signal is DC-coupled.
- 6) $V_{CC} = 5.0V$.
- 7) $I_{CC} = 26mA$.

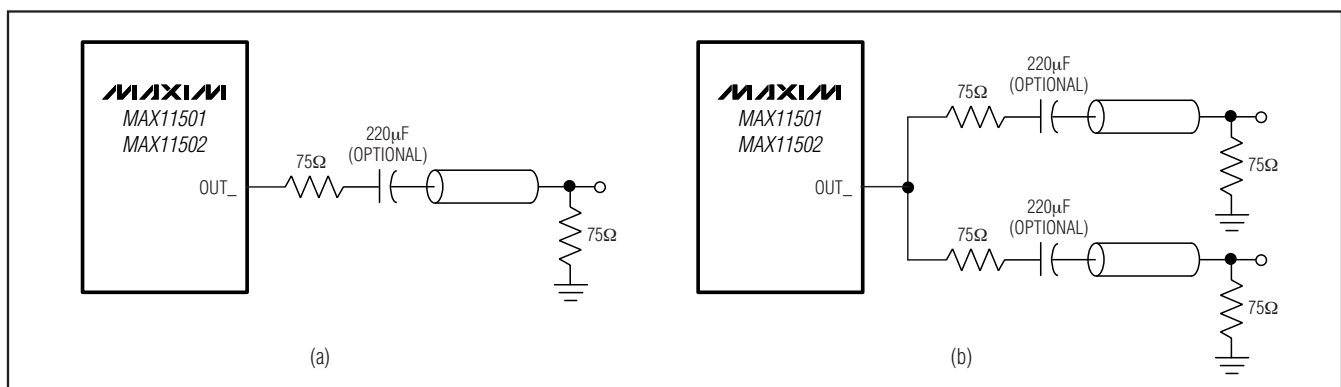

Figure 5. Typical Output Loads

Three-Channel, Standard-Definition Video Filters

A sync tip exists at 280mV and peak white exists at 2.28V. The RMS voltage is approximately 1.88V on each output (80% of the peak-to-peak voltage, plus the offset) giving:

$$P_{DS} = 5 \times 0.026 = 0.13W$$

$$P_{DOn} = \frac{(5 - 1.88) \times 1.88}{75} = 0.078W$$

and

$$P_D = 0.13 + 0.078 + 0.078 + 0.078 = 0.364W$$

The junction temperature is given by:

$$T_J = T_A + (R_{\theta JA} \times P_D)$$

where T_J is junction temperature, T_A is ambient temperature (assume +70°C), and $R_{\theta JA}$ is thermal resistance junction to ambient.

From the *Absolute Maximum Ratings* section of the data sheet, the derating factor is 5.9mW/°C above +70°C. $R_{\theta JA} = 1/(\text{derating factor}) = 1/(5.9\text{mW}/^\circ\text{C}) = 170^\circ\text{C}/W$ (derating and maximum power dissipation are based on minimum PCB copper and indicate worst case).

Therefore:

$$T_J = 70 + (170 \times 0.364) = +132^\circ\text{C}$$

In this example, the die temperature is below the absolute maximum allowed temperature. It is unlikely under normal circumstances that the maximum die temperature will be reached, however it is possible if tolerances of V_{CC} , R_L , input voltage etc. are considered and the ambient temperature is high.

Changing the above example to a single video load on each output results in:

$$T_J = +112^\circ\text{C}$$

PCB Layout Recommendations

To help with heat dissipation, connect the power and ground traces to large copper areas. Bypass V_{CC} to GND with 0.1μF and 1.0μF capacitors. Surface-mount capacitors are recommended for their low inductance. Place traces carrying video signals appropriately to avoid mutual coupling. When AC-coupling the inputs, place the capacitors as close as possible to the device and keep traces short to minimize parasitic capacitance and inductance. For a recommended PCB layout, refer to the MAX11501/MAX11502 evaluation kit datasheet.

Three-Channel, Standard-Definition Video Filters

Pin Configuration

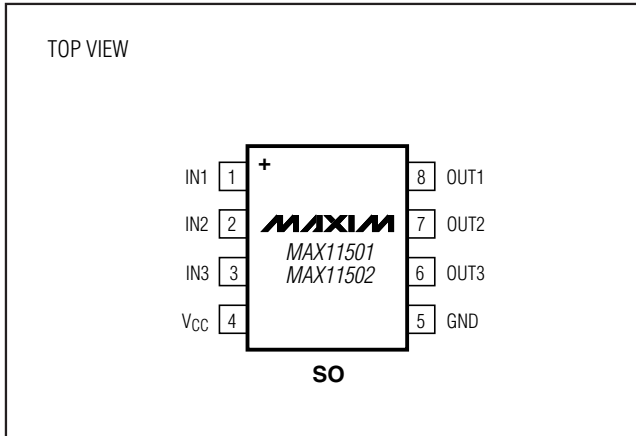

Typical Operating Circuit

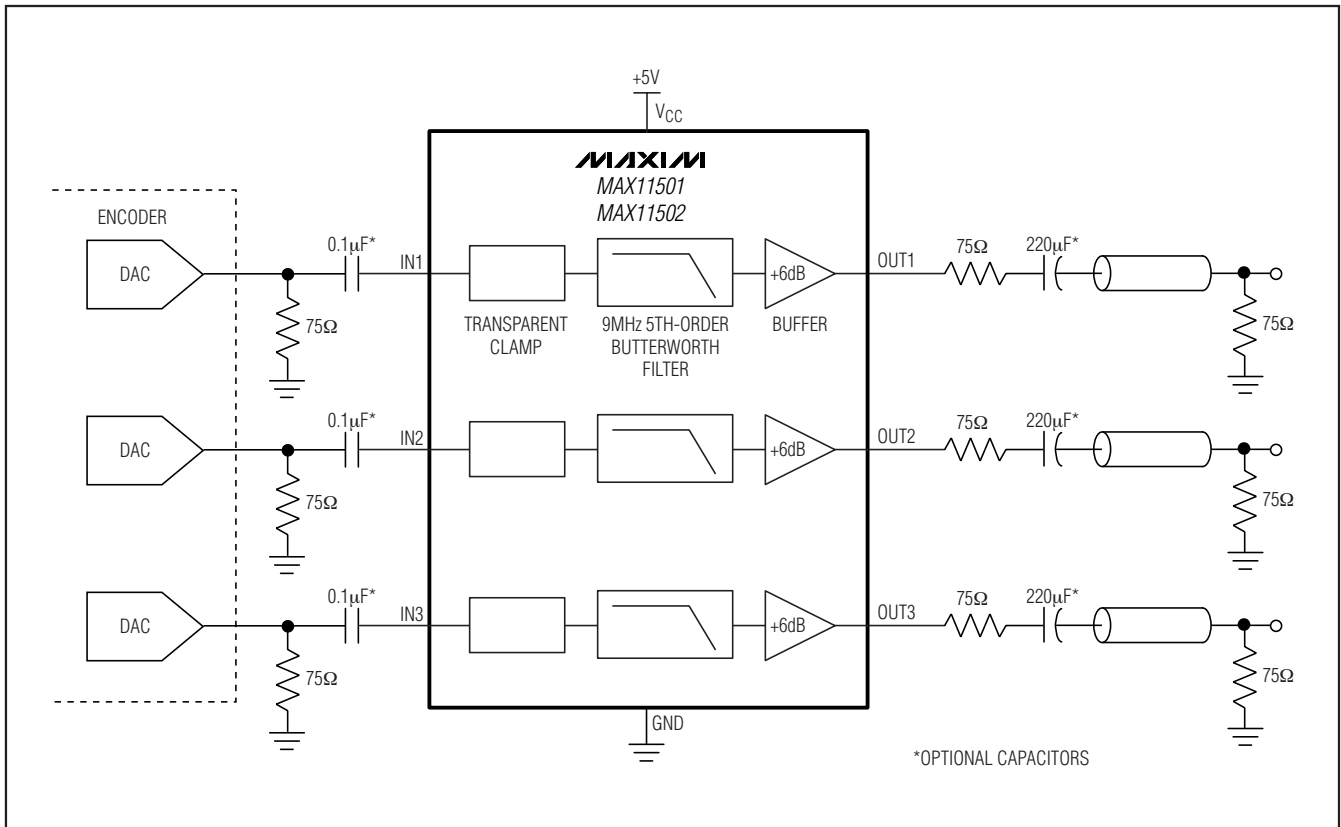

MAX11501/MAX11502

Three-Channel, Standard-Definition Video Filters

Package Information

For the latest package outline information, go to www.maxim-ic.com/packages.

PACKAGE TYPE	PACKAGE CODE	DOCUMENT NO.
8 SO	S8+2	21-0041

MAX11501/MAX11502

Three-Channel, Standard-Definition Video Filters

Revision History

REVISION NUMBER	REVISION DATE	DESCRIPTION	PAGES CHANGED
0	12/07	Initial release	—
1	4/08	Updated Block Diagram	1

MAX11501/MAX11502

Maxim cannot assume responsibility for use of any circuitry other than circuitry entirely embodied in a Maxim product. No circuit patent licenses are implied. Maxim reserves the right to change the circuitry and specifications without notice at any time.

Maxim Integrated Products, 120 San Gabriel Drive, Sunnyvale, CA 94086 408-737-7600 _____ 11

OUR CERTIFICATE

DiGi provide top-quality products and perfect service for customer worldwide through standardization, technological innovation and continuous improvement. DiGi through third-party certification, we strictly control the quality of products and services. Welcome your RFQ to

Email: Info@DiGi-Electronics.com



Tel: +00 852-30501935

RFQ Email: Info@DiGi-Electronics.com

DiGi is a global authorized distributor of electronic components.