

MAX4075AOESA+T Datasheet

www.digi-electronics.com



<https://www.DiGi-Electronics.com>

DiGi Electronics Part Number	MAX4075AOESA+T-DG
Manufacturer	Analog Devices Inc./Maxim Integrated
Manufacturer Product Number	MAX4075AOESA+T
Description	IC OPAMP GP 2 CIRCUIT 8SOIC
Detailed Description	General Purpose Amplifier 2 Circuit Rail-to-Rail 8-S OIC



Tel: +00 852-30501935

RFQ Email: Info@DiGi-Electronics.com

DiGi is a global authorized distributor of electronic components.

Purchase and inquiry

Manufacturer Product Number:

MAX4075AOESA+T

Series:

GainAmp™

Amplifier Type:

General Purpose

Output Type:

Rail-to-Rail

Gain Bandwidth Product:

4 MHz

Current - Input Bias:

0.8 pA

Current - Supply:

37µA (x2 Channels)

Voltage - Supply Span (Min):

2.5 V

Operating Temperature:

-40°C ~ 70°C

Package / Case:

8-SOIC (0.154", 3.90mm Width)

Base Product Number:

MAX4075

Manufacturer:

Analog Devices Inc./Maxim Integrated

Product Status:

Obsolete

Number of Circuits:

2

Slew Rate:

0.1V/µs

-3db Bandwidth:

90 kHz

Voltage - Input Offset:

200 µV

Current - Output / Channel:

22 mA

Voltage - Supply Span (Max):

5.5 V

Mounting Type:

Surface Mount

Supplier Device Package:

8-SOIC

Environmental & Export classification

RoHS Status:

ROHS3 Compliant

REACH Status:

REACH Unaffected

HTSUS:

8542.33.0001

Moisture Sensitivity Level (MSL):

1 (Unlimited)

ECCN:

EAR99

MAXIM

Micropower, SOT23, Rail-to-Rail, Fixed-Gain, GainAmp/Open-Loop Op Amps

General Description

The MAX4074–MAX4078 GainAmp™ op amp family combines low-cost Rail-to-Rail® op amps with precision internal gain-setting resistors. Factory-trimmed on-chip resistors decrease design size, cost, and layout, and provide 0.1% gain accuracy. Fixed inverting gains from -0.25V/V to -100V/V or noninverting gains from +1.25V/V to +101V/V are available. These devices operate from a single +2.5V to +5.5V supply and consume just 34μA. GainAmp amplifiers are optimally compensated for each gain version, achieving gain bandwidth (GBW) products up to 4MHz ($A_v = +25V/V$ to +101V/V). High-voltage fault protection withstands ±17V at either input without damage or excessive current draw (MAX4074/MAX4075 only).

Two versions are available in this amplifier family. The MAX4076/MAX4077/MAX4078 are single/dual/quad open-loop, unity-gain-stable op amps, and the MAX4074/MAX4075 are single/dual fixed-gain op amps. The input common-mode voltage range of the open-loop amplifiers extends from 150mV below the negative supply to within 1.2V of the positive supply. The GainAmp outputs can swing rail-to-rail and drive a 1kΩ load while maintaining excellent DC accuracy (MAX4074/MAX4075 only). The amplifiers are stable for capacitive loads up to 100pF.

For space-critical applications, the MAX4074/MAX4076 are available in space-saving SOT23-5 packages.

Applications

Portable Battery-Powered Equipment
Instruments, Terminals, and Bar-Code Readers
Keyless Entry
Photodiode Preamps
Smart-Card Readers
Infrared Receivers for Remote Controls
Low-Side Current-Sense Amplifiers

Gain Selector Guide appears at end of data sheet.

Typical Operating Circuit appears at end of data sheet.

GainAmp is a trademark of Maxim Integrated Products.

Rail-to-Rail is a registered trademark of Nippon Motorola, Ltd.

Features

- ◆ Internal Gain-Setting Resistors in SOT23 Packages (MAX4074)
- ◆ 0.1% Gain Accuracy (R_F/R_G) (MAX4074/75)
- ◆ 54 Standard Gains Available (MAX4074/75)
- ◆ Open-Loop, Unity-Gain-Stable Op Amps (MAX4076/77/78)
- ◆ Rail-to-Rail Outputs Drive 1kΩ Load (MAX4074/75)
- ◆ +2.5V to +5.5V Single Supply
- ◆ 34μA Supply Current (MAX4074/75)
- ◆ Up to 4MHz GBW Product
- ◆ Fault-Protected Inputs Withstand ±17V (MAX4074/75)
- ◆ 200pA max Input Bias Current (MAX4076/77/78)
- ◆ Stable with Capacitive Loads up to 100pF with No Isolation Resistor

Ordering Information

PART	TEMP. RANGE	PIN-PACKAGE	TOP MARK
MAX4074__EUK-T	-40°C to +70°C	5 SOT23-5	**
MAX4074__ESA	-40°C to +70°C	8 SO	—

Ordering Information continued at end of data sheet.

Note: Insert the desired gain code in the blank to complete the part number (see the Gain Selector Guide).

**See the Gain Selector Guide for a list of preferred gains and top marks.

Pin Configurations/ Functional Diagrams

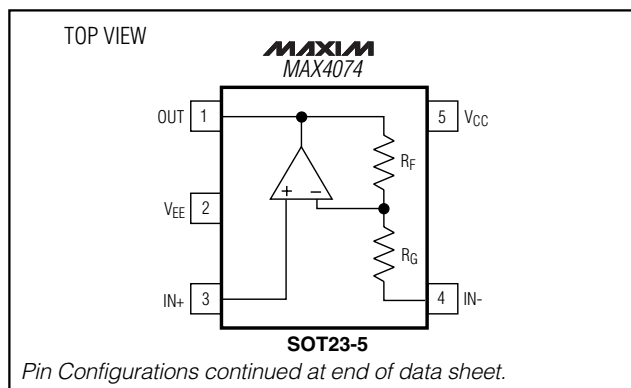
**MAXIM**

Maxim Integrated Products 1

**For free samples & the latest literature: <http://www.maxim-ic.com>, or phone 1-800-998-8800.
For small orders, phone 1-800-835-8769.**

MAX4074-MAX4078

Micropower, SOT23, Rail-to-Rail, Fixed-Gain, GainAmp/Open-Loop Op Amps

MAX4074-MAX4078

ABSOLUTE MAXIMUM RATINGS

Supply Voltages (V_{CC} to V_{EE})-0.3V to +6V
 Voltage Inputs (IN_{-})
 MAX4076/MAX4077/MAX4078($V_{CC} + 0.3V$) to ($V_{EE} - 0.3V$)
 MAX4074/MAX4075 $\pm 17V$
 Output Short-Circuit Duration to Either Supply (OUT_{-}).... Continuous
 Continuous Power Dissipation ($T_A = +70^{\circ}C$)
 5-Pin SOT23 (derate 7.1mW/ $^{\circ}C$ above $+70^{\circ}C$)571mW
 14-Pin TSSOP (derate 6.3mW/ $^{\circ}C$ above $+70^{\circ}C$)500mW

8-Pin μ MAX (derate 4.1mW/ $^{\circ}C$ above $+70^{\circ}C$)330mW
 8-Pin SO (derate 5.88mW/ $^{\circ}C$ above $+70^{\circ}C$).....471mW
 14-Pin SO (derate 8.33mW/ $^{\circ}C$ above $+70^{\circ}C$).....667mW
 Operating Temperature Range-40 $^{\circ}C$ to +85 $^{\circ}C$
 Junction Temperature+150 $^{\circ}C$
 Storage Temperature Range-65 $^{\circ}C$ to +150 $^{\circ}C$
 Lead Temperature (soldering, 10sec)+300 $^{\circ}C$

Stresses beyond those listed under "Absolute Maximum Ratings" may cause permanent damage to the device. These are stress ratings only, and functional operation of the device at these or any other conditions beyond those indicated in the operational sections of the specifications is not implied. Exposure to absolute maximum rating conditions for extended periods may affect device reliability.

ELECTRICAL CHARACTERISTICS—MAX4074/MAX4075

($V_{CC} = +2.5V$ to $+5.5V$, $V_{EE} = 0$, $V_{IN+} = V_{IN-} = V_{CC}/2$, $R_L = \infty$ to $V_{CC}/2$, $T_A = T_{MIN}$ to T_{MAX} , unless otherwise noted. Typical values are at $V_{CC} = +5V$ and $T_A = +25^{\circ}C$.) (Note 1)

PARAMETER	SYMBOL	CONDITIONS	MIN	TYP	MAX	UNITS
Supply Voltage Range	V_{CC}	Guaranteed by PSRR test	2.5		5.5	V
Supply Current (per amplifier)	I_{CC}	$V_{CC} = 5V$		37	55	μA
		$V_{CC} = 3V$		34	50	
Input Offset Voltage	V_{OS}	$R_L = 1M\Omega$		0.2	3.5	mV
Input Offset Voltage Drift				0.3		$\mu V/^{\circ}C$
Input Bias Current (Note 2)	I_{IN+}			0.8	1000	pA
Inverting Input Resistance	R_{IN-}	$A_V < +25V/V$		300		k Ω
		$A_V \geq +25V/V$		80		
Noninverting Input Resistance	R_{IN+}			1000		M Ω
Positive Input Voltage Range	IN_{+}	Guaranteed by functional test (Note 3)	$V_{EE} - 0.15$		$V_{CC} - 1.2$	V
Negative Input Voltage Range	IN_{-}	Guaranteed by functional test (Note 3)		± 15		V
Power-Supply Rejection Ratio	PSRR	$V_{CC} = 2.5V$ to $5.5V$	70	96		dB
Closed-Loop Output Impedance	R_{OUT}			0.2		Ω
Output Short-Circuit Current		Shorted to V_{CC}		5		mA
		Shorted to V_{EE}		-22		
Output Voltage Swing (Note 4)	$R_L = 1M\Omega$	$V_{CC} - V_{OH}$		0.5	2.5	mV
		$V_{OL} - V_{EE}$		0.4	2.5	
	$R_L = 10k\Omega$	$V_{CC} - V_{OH}$		25	150	
		$V_{OL} - V_{EE}$		11	80	
	$R_L = 1k\Omega$	$V_{CC} - V_{OH}$		300	1000	
		$V_{OL} - V_{EE}$		100	600	

Micropower, SOT23, Rail-to-Rail, Fixed-Gain, GainAmp/Open-Loop Op Amps

MAX4074-MAX4078

ELECTRICAL CHARACTERISTICS—MAX4074/MAX4075 (continued)

($V_{CC} = +2.5V$ to $+5.5V$, $V_{EE} = 0$, $V_{IN+} = V_{IN-} = V_{CC}/2$, $R_L = \infty$ to $V_{CC}/2$, $T_A = T_{MIN}$ to T_{MAX} , unless otherwise noted. Typical values are at $V_{CC} = +5V$ and $T_A = +25^\circ C$.) (Note 1)

PARAMETER	SYMBOL	CONDITIONS	MIN	TYP	MAX	UNITS
Power-Up Time		Output settling to 1%		9		ms
Slew Rate	SR	$V_{OUT} = 4V$ step		100		V/ms
Settling Time (to 0.01%)		$V_{OUT} = 4V$ step		60		μs
Input Voltage Noise Density	e_n	$f = 5kHz$ (Note 5)		150		nV/\sqrt{Hz}
Input Noise Current Density		$f = 5kHz$		500		fA/\sqrt{Hz}
Capacitive Load Stability	C_{LOAD}	No sustained oscillations		500		pF
DC Gain Accuracy		$(V_{EE} + 25mV) < V_{OUT} < (V_{CC} - 25mV)$, $R_L = 1M\Omega$ (Note 6)	$T_A = +25^\circ C$	0.01	1.0	%
			$T_A = T_{MIN}$ to T_{MAX}		1.2	
-3dB Bandwidth	BW (-3dB)	$A_V = +1.25V/V$		200		kHz
		$A_V = +3V/V$		90		
		$A_V = +5V/V$		80		
		$A_V = +10V/V$		90		
		$A_V = +25V/V$		120		

ELECTRICAL CHARACTERISTICS—MAX4076/MAX4077/MAX4078

($V_{CC} = +2.5V$ to $+5.5V$, $V_{EE} = 0$, $V_{IN+} = V_{IN-} = V_{CC}/2$, $R_L = \infty$ to $V_{CC}/2$, $T_A = T_{MIN}$ to T_{MAX} , unless otherwise noted. Typical values are at $V_{CC} = +5V$ and $T_A = +25^\circ C$.) (Note 1)

PARAMETER	SYMBOL	CONDITIONS	MIN	TYP	MAX	UNITS
Supply Voltage Range	V_{CC}	Guaranteed by PSRR test	2.5		5.5	V
Supply Current (per amplifier)	I_{CC}	$V_{CC} = 5V$		45	60	μA
		$V_{CC} = 3V$		40	55	
Input Offset Voltage	V_{OS}	$R_L = 1M\Omega$		1.2	3.5mV	mV
Input Offset Voltage Drift				1.5 μV		$\mu V/^\circ C$
Input Bias Current (Note 2)	I_{BIAS}			1	200	pA
Input Offset Current	I_{OS}			± 0.4		pA
Common-Mode Input Voltage Range	I_{VR}	Guaranteed by CMRR	0.15		$V_{CC} - 1.2$	V
Common-Mode Rejection Ratio	CMRR	$(V_{CC} - 1.2V) \geq V_{CM} \geq -0.15V$	70	95		dB
Power-Supply Rejection Ratio	PSRR	$V_{CC} = 2.5V$ to $5.5V$	70	95		dB
Closed-Loop Output Impedance	R_{OUT}	$A_V = +1V/V$		0.2		Ω
Output Short-Circuit Current		Shorted to V_{CC}		4.5		mA
		Shorted to V_{EE}		20		
Large-Signal Voltage Gain	A_{VOL}	$0.05V < V_{OUT} < (V_{CC} - 0.1V)$, $R_L = 1M\Omega$	80	117		dB
		$0.25V < V_{OUT} < (V_{CC} - 0.3V)$, $R_L = 10k\Omega$	80	95		
		$0.25V < V_{OUT} < (V_{CC} - 0.3V)$, $R_L = 5k\Omega$	80	93		

Micropower, SOT23, Rail-to-Rail, Fixed-Gain, GainAmp/Open-Loop Op Amps

MAX4074-MAX4078

ELECTRICAL CHARACTERISTICS—MAX4076/MAX4077/MAX4078 (continued)

($V_{CC} = +2.5V$ to $+5.5V$, $V_{EE} = 0$, $V_{IN+} = V_{IN-} = V_{CC}/2$, $R_L = \infty$ to $V_{CC}/2$, $T_A = T_{MIN}$ to T_{MAX} , unless otherwise noted. Typical values are at $V_{CC} = +5V$ and $T_A = +25^\circ C$.) (Note 1)

PARAMETER	SYMBOL	CONDITIONS		MIN	TYP	MAX	UNITS
Output Voltage Swing	V_{OH}/V_{OL}	$R_L = 1M\Omega$	$V_{CC} - V_{OH}$	0.23	2.5	mV	
			$V_{OL} - V_{EE}$	0.22	2.5		
		$R_L = 10k\Omega$	$V_{CC} - V_{OH}$	12	50		
			$V_{OL} - V_{EE}$	7	50		
		$R_L = 5k\Omega$	$V_{CC} - V_{OH}$	100	100		
			$V_{OL} - V_{EE}$	100	100		
Gain-Bandwidth Product	GBW			230		kHz	
Slew Rate	SR	$V_{OUT} = 4V$ step		90		V/ms	
Settling Time (to 0.01%)		$V_{OUT} = 4V$ step		69		μs	
Input Voltage Noise Density	e_n	$f = 5kHz$		110		nV/\sqrt{Hz}	
Input Noise Current Density		$f = 5kHz$		1.1		fA/\sqrt{Hz}	
Capacitive Load Stability	C_{LOAD}	No sustained oscillations, $A_V = +1V/V$		100		pF	
Power-Up Time		Output settling to 1%		10		ms	

Note 1: All devices are 100% production tested at $T_A = +25^\circ C$. All temperature limits are guaranteed by design.

Note 2: Guaranteed by design.

Note 3: The input common-mode range for IN_+ is guaranteed by a functional test. A similar test is done on the IN_- input. See the *Applications Information* section for more information on the input voltage range of the GainAmps.

Note 4: For $A_V = -0.5V/V$ and $A_V = -0.25V/V$, the output voltage swing may be limited by the input voltage range.

Note 5: Includes noise from on-chip resistors.

Note 6: The gain accuracy test is performed with the GainAmps in the noninverting configuration. The output voltage swing is limited by the input voltage range for certain gains and supply voltage conditions. For situations where the output voltage swing is limited by the valid input range, the output limits are adjusted accordingly.

Typical Operating Characteristics

($V_{CC} = +5.0V$, $R_L = 100k\Omega$ to $V_{CC}/2$, $T_A = +25^\circ C$, unless otherwise noted.)

MAX4074/MAX4075

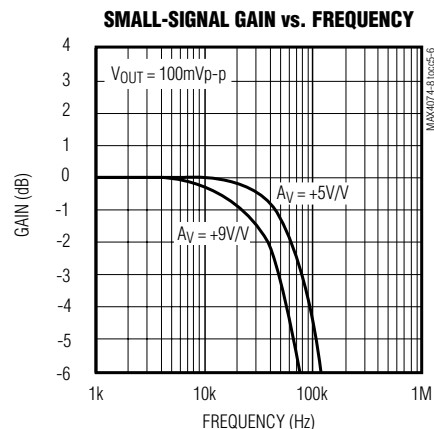
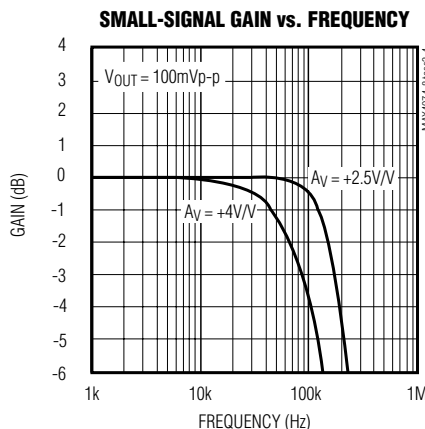
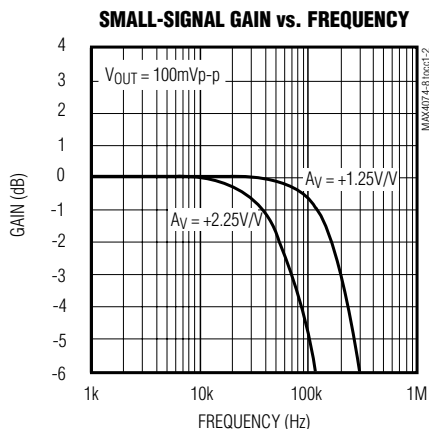

Micropower, SOT23, Rail-to-Rail, Fixed-Gain, GainAmp/Open-Loop Op Amps

Typical Operating Characteristics

($V_{CC} = +5.0V$, $R_L = 100k\Omega$ to $V_{CC}/2$, $T_A = +25^\circ C$, unless otherwise noted.)

MAX4074-MAX4078

MAX4074/MAX4075

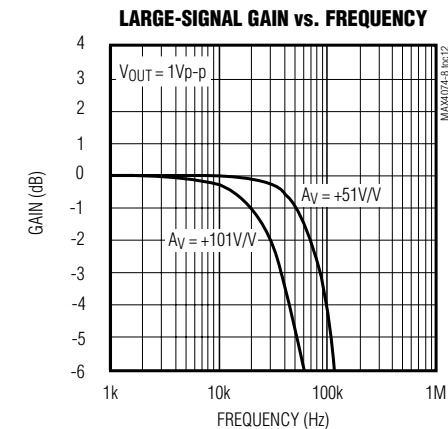
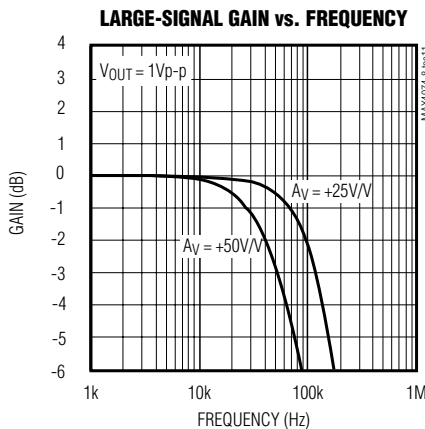
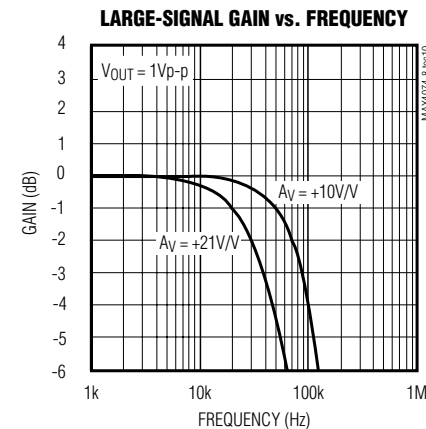
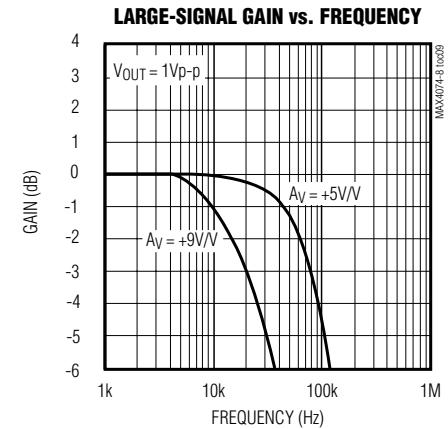
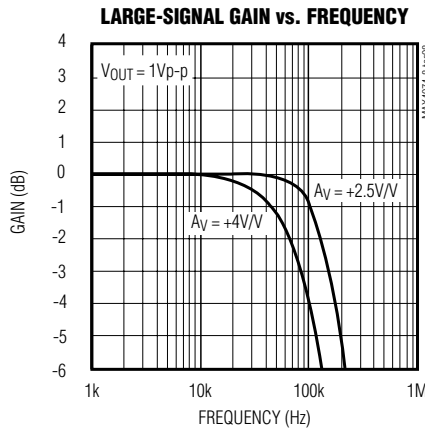
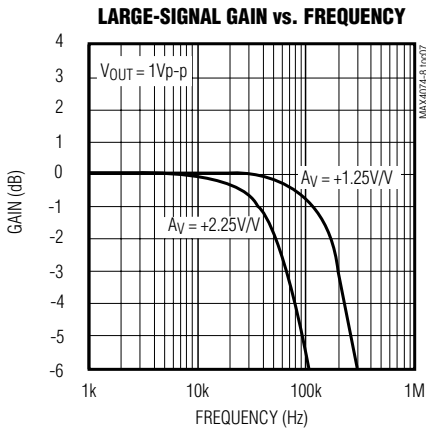
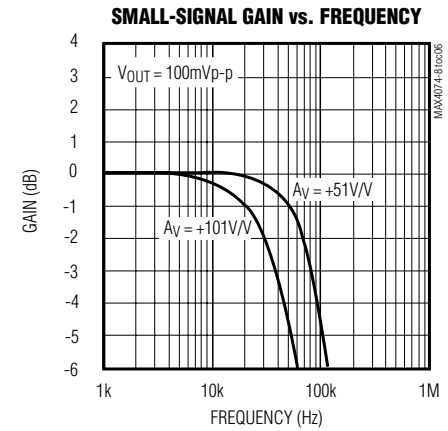
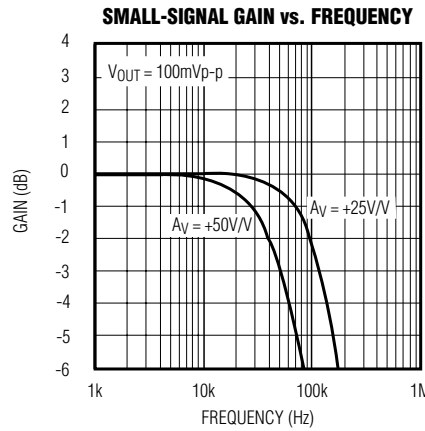
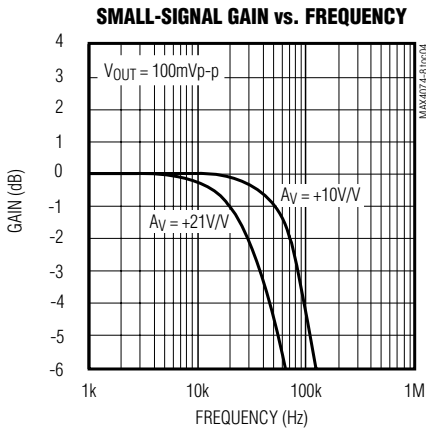

Micropower, SOT23, Rail-to-Rail, Fixed-Gain, GainAmp/Open-Loop Op Amps

Typical Operating Characteristics (continued)

($V_{CC} = +5.0V$, $R_L = 100k\Omega$ to $V_{CC}/2$, $T_A = +25^\circ C$, unless otherwise noted.)

MAX4074/MAX4075

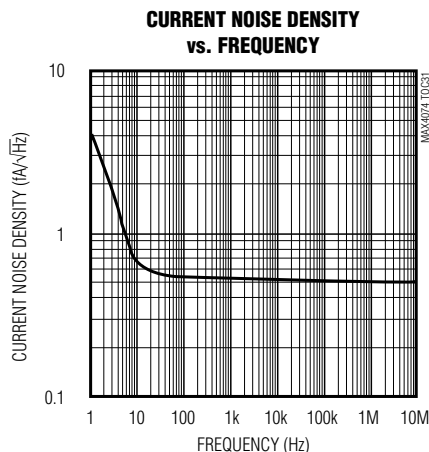
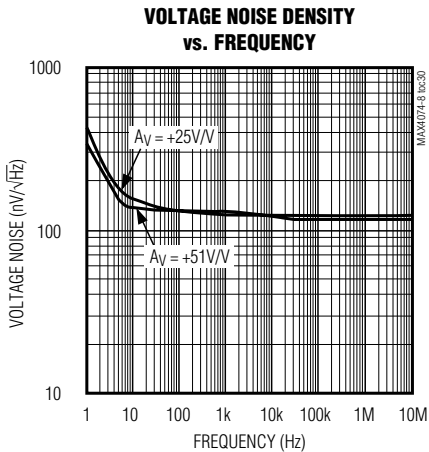
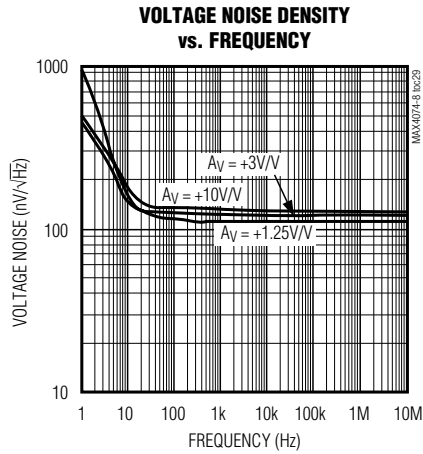
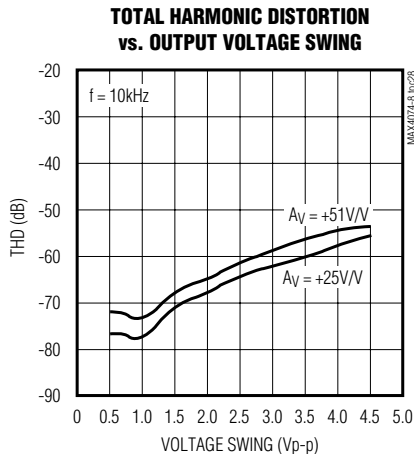
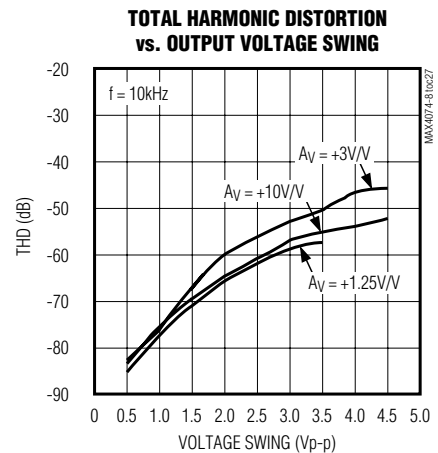
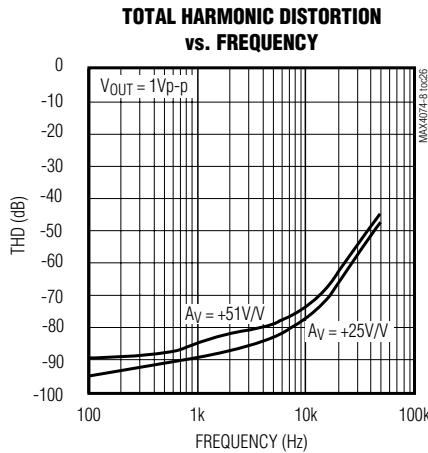
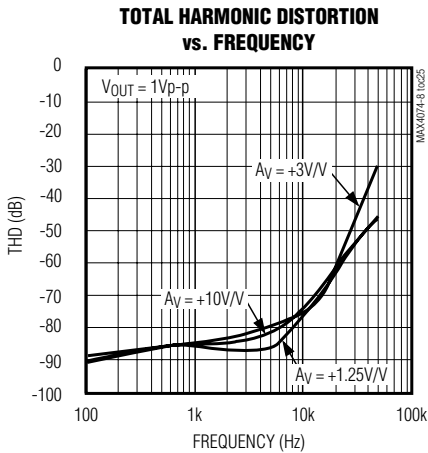

Micropower, SOT23, Rail-to-Rail, Fixed-Gain, GainAmp/Open-Loop Op Amps

Typical Operating Characteristics (continued)

($V_{CC} = +5.0V$, $R_L = 100k\Omega$ to $V_{CC}/2$, $T_A = +25^\circ C$, unless otherwise noted.)

MAX4074/MAX4075

MAX4074-MAX4078

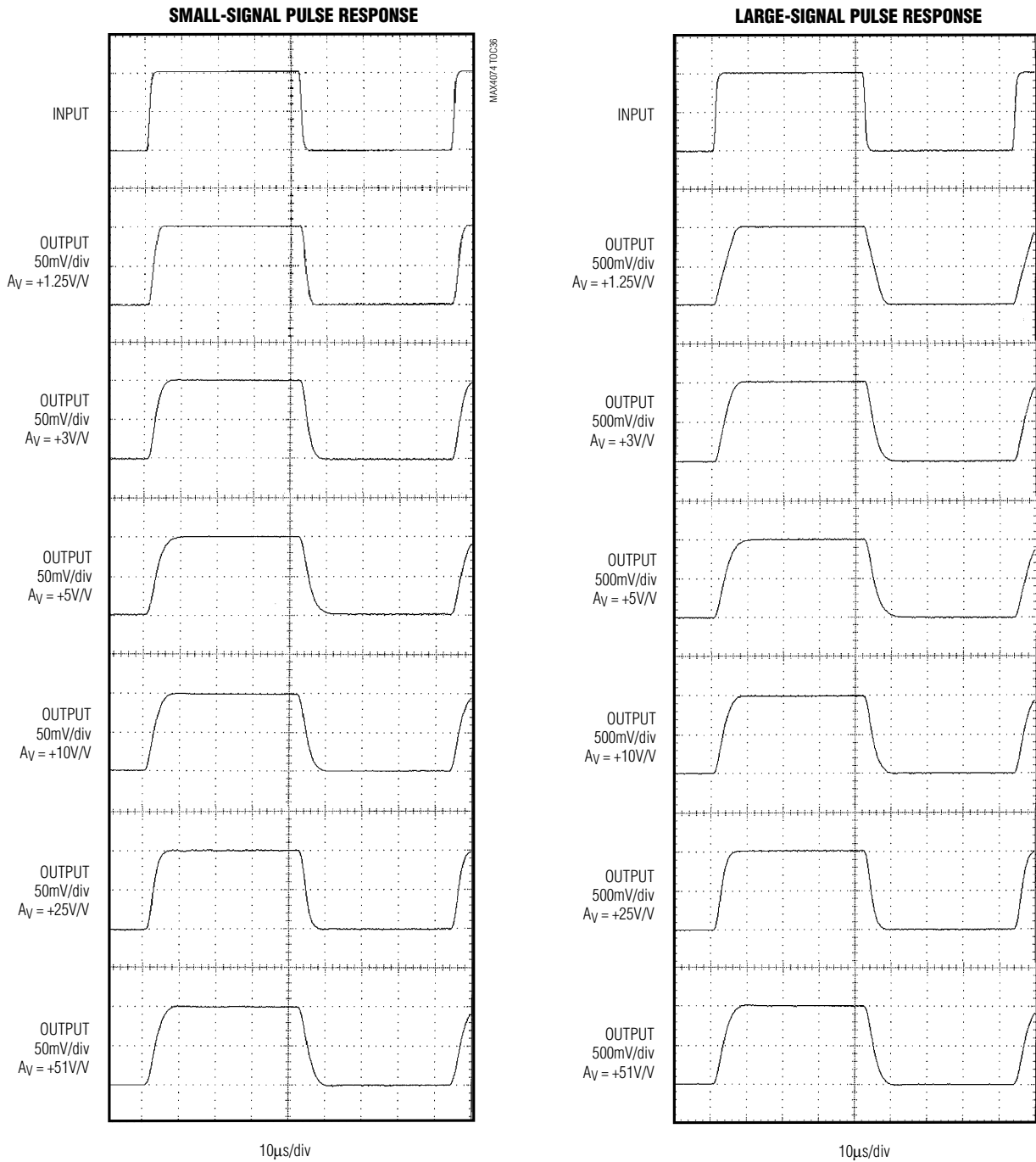

Micropower, SOT23, Rail-to-Rail, Fixed-Gain, GainAmp/Open-Loop Op Amps

Typical Operating Characteristics (continued)

($V_{CC} = +5.0V$, $R_L = 100k\Omega$ to $V_{CC}/2$, $T_A = +25^\circ C$, unless otherwise noted.)

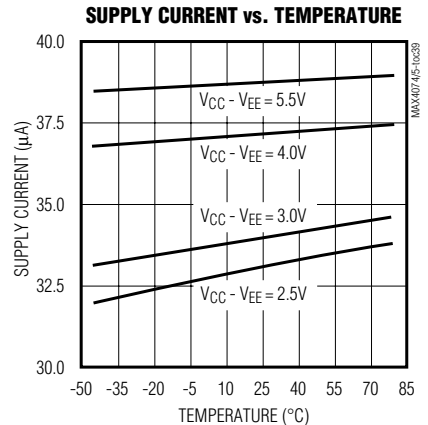
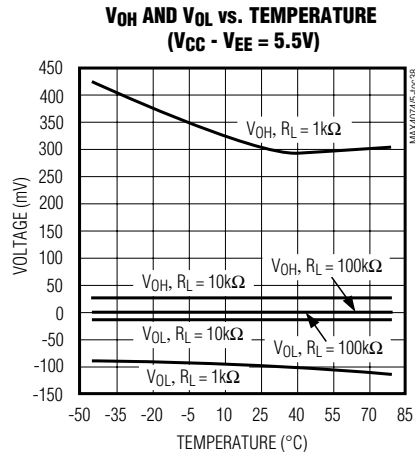
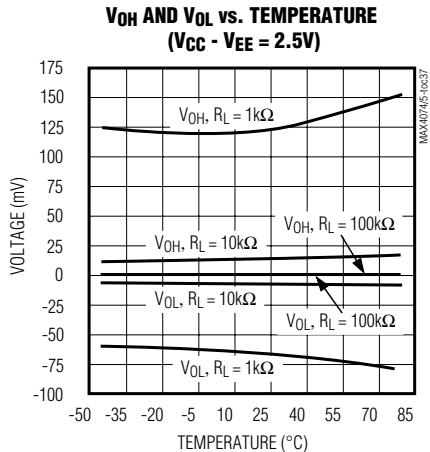
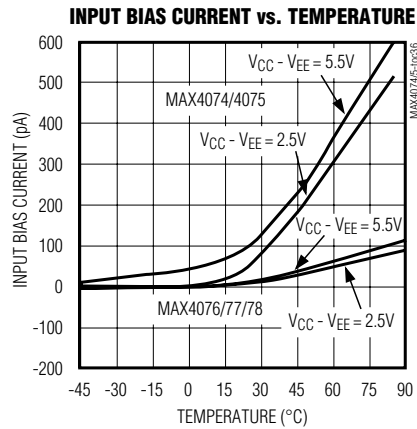
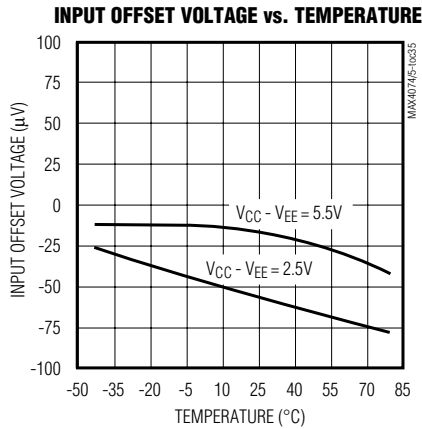
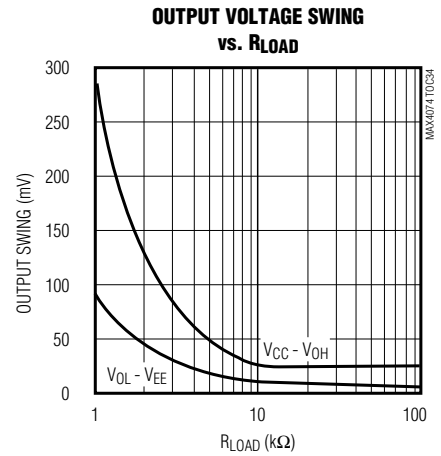
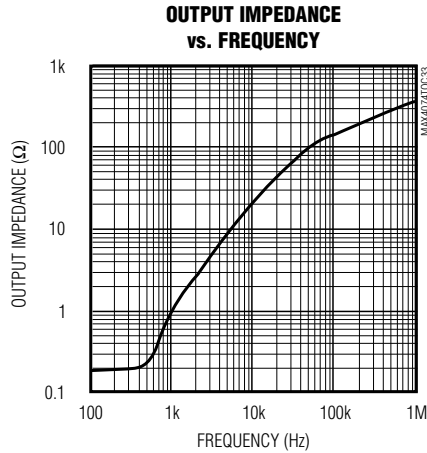
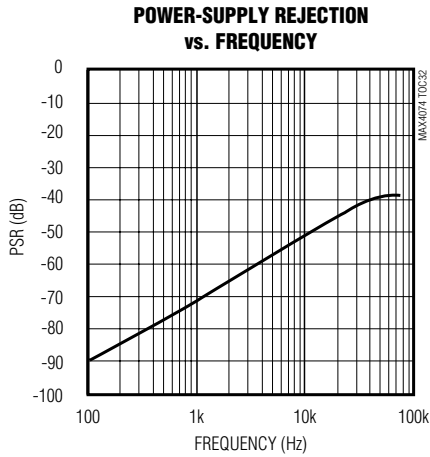

Micropower, SOT23, Rail-to-Rail, Fixed-Gain, GainAmp/Open-Loop Op Amps

Typical Operating Characteristics (continued)

($V_{CC} = +5.0V$, $R_L = 100k\Omega$ to $V_{CC}/2$, $T_A = +25^\circ C$, unless otherwise noted.)

MAX4076/MAX4077/MAX4078

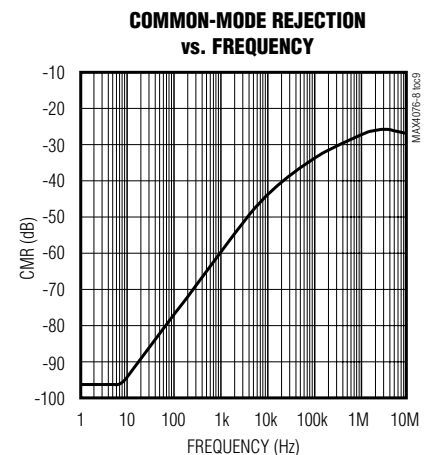
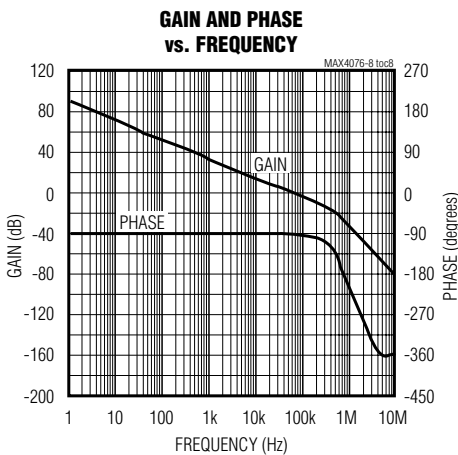
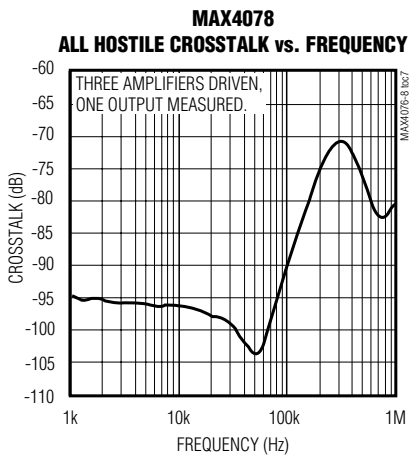
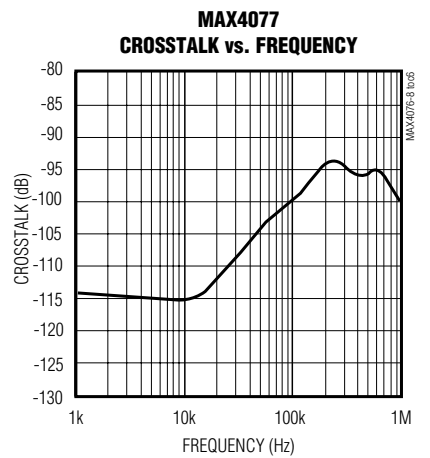
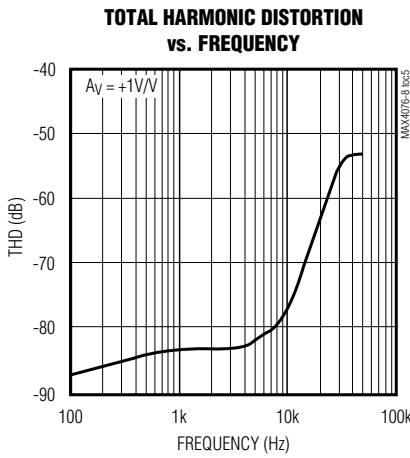
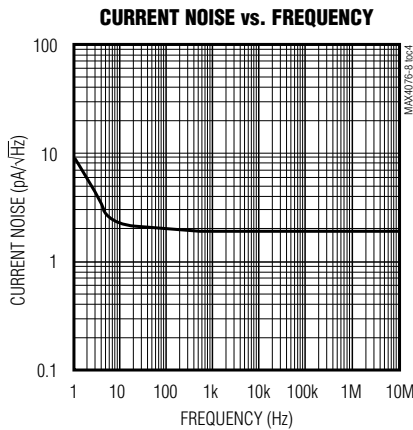
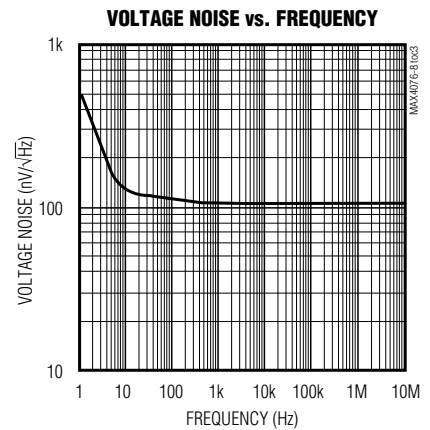
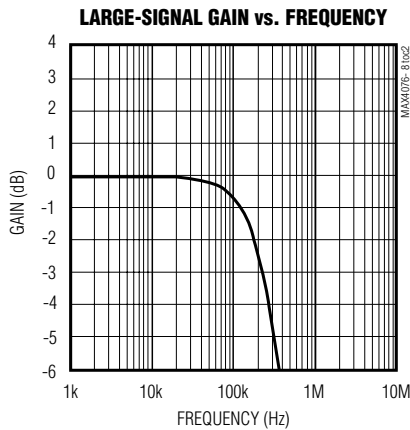
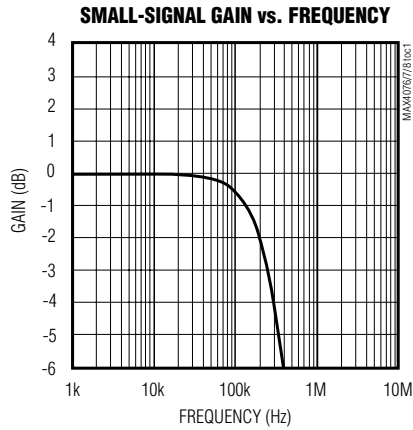

MAX4074-MAX4078

Micropower, SOT23, Rail-to-Rail, Fixed-Gain, GainAmp/Open-Loop Op Amps

Pin Description

PIN				NAME	FUNCTION
MAX4074/MAX4076		MAX4075 MAX4077	MAX4078		
SOT23	SO	μ MAX/SO	SO/TSSOP		
1	6	1, 7	1, 7, 8, 14	OUT_	Amplifier Output
2	4	4	11	VEE	Negative Supply or Ground
3	3	3, 5	3, 5, 10, 12	IN_+	Noninverting Amplifier Input
4	2	2, 6	2, 6, 9, 13	IN_-	Inverting Amplifier Input
5	7	8	4	VCC	Positive Supply
—	1, 5, 8	—	—	N.C.	No Connection. Not internally connected.

Detailed Description

Maxim's GainAmp fixed-gain amplifiers combine a low-cost rail-to-rail op amp with internal gain-setting resistors. Factory-trimmed on-chip resistors provide 0.1% gain accuracy while decreasing design size, cost, and layout. There are two versions in this amplifier family: single/dual/quad open-loop, unity-gain-stable devices (MAX4076/MAX4077/MAX4078), and single/dual fixed-gain devices (MAX4074/MAX4075). All amplifiers feature rail-to-rail outputs and drive a 10k Ω load while maintaining excellent DC accuracy.

Open-Loop Op Amps

The single/dual/quad MAX4076/MAX4077/MAX4078 are low-power, open-loop op amps with rail-to-rail outputs. These devices are compensated for unity-gain stability and feature a GBW product of 230kHz. The common-mode range extends from 150mV below the negative rail to within 1.2V of the positive rail. These high-performance op amps serve as the core for this family of GainAmp fixed-gain amplifiers. Although the -3dB bandwidth will not correspond to that of a fixed-gain amplifier in higher gain configurations, these open-loop op amps can be used to prototype designs.

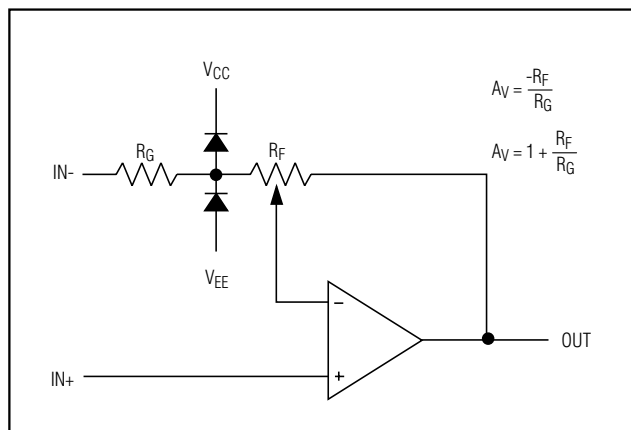

Figure 1. Internal Gain-Setting Resistors

Internal Gain-Setting Resistors

Maxim's proprietary laser trimming techniques allow R_F/R_G values (Figure 1) that produce many different gain configurations. These GainAmp fixed-gain amplifiers feature a negative-feedback resistor network that is laser trimmed to provide a gain-setting feedback ratio (R_F/R_G) with 0.1% typical accuracy. The standard op amp pinouts allow the GainAmp fixed-gain amplifiers to plug directly into existing board designs, easily replacing op amps-plus-resistor gain blocks.

Micropower, SOT23, Rail-to-Rail, Fixed-Gain, GainAmp/Open-Loop Op Amps

GainAmp Bandwidth

GainAmp fixed-gain amplifiers feature factory-trimmed precision resistors to provide fixed inverting gains from -0.25V/V to -100V/V or noninverting gains from $+1.25\text{V/V}$ to $+101\text{V/V}$. The op amp core is decompensated strategically over the gain-set options to maximize bandwidth. Open-loop decompensation increases GBW product, ensuring that usable bandwidth is maintained with increasing closed-loop gains. A GainAmp with a fixed gain of $A_V = +25\text{V/V}$ has a -3dB bandwidth of 120kHz . By comparison, a unity-gain-stable op amp configured for $A_V = +25\text{V/V}$ would yield a -3dB bandwidth of only 8kHz . Decompensation is performed at five intermediate gain sets, as shown in the *Gain Selector Guide*.

High-Voltage ($\pm 17\text{V}$) Input Fault Protection

The MAX4074/MAX4075 family includes $\pm 17\text{V}$ input fault protection. For normal operation, see the input voltage range specification in the *Electrical Characteristics*. Overdriven inputs up to $\pm 17\text{V}$ will not cause output phase reversal. A back-to-back SCR structure at the input pins allows either input to safely swing $\pm 17\text{V}$ relative to V_{EE} (Figure 2). Additionally, the internal op amp inputs are diode clamped to both supply rails for

the protection of sensitive input stage circuitry. Current through the clamp diodes is limited by a $5\text{k}\Omega$ resistor at the noninverting input, and by R_G at the inverting input. An $\text{IN}+$ or $\text{IN}-$ fault voltage as high as $\pm 17\text{V}$ causes less than 3.5mA to flow through the input pin, protecting both the GainAmp and the signal source from damage.

Applications Information

GainAmp fixed-gain amplifiers offer a precision, fixed-gain amplifier in a small package that can be used in a variety of circuit board designs. GainAmp fixed-gain amplifiers can be used in many op amp circuits that use resistive negative feedback to set gain, and do not require other connections to the op amp inverting input. Both inverting and noninverting op amp configurations can be implemented easily using a GainAmp.

GainAmp Input Voltage Range

The MAX4074/MAX4075 combine both an op amp and gain-setting feedback resistors on the same IC. The inverting input voltage range is different from the noninverting input voltage range because the inverting input pin is connected to the R_G input series resistor. Just as with a discrete design, take care not to saturate the inputs/output of the core op amp to avoid signal distortions or clipping.

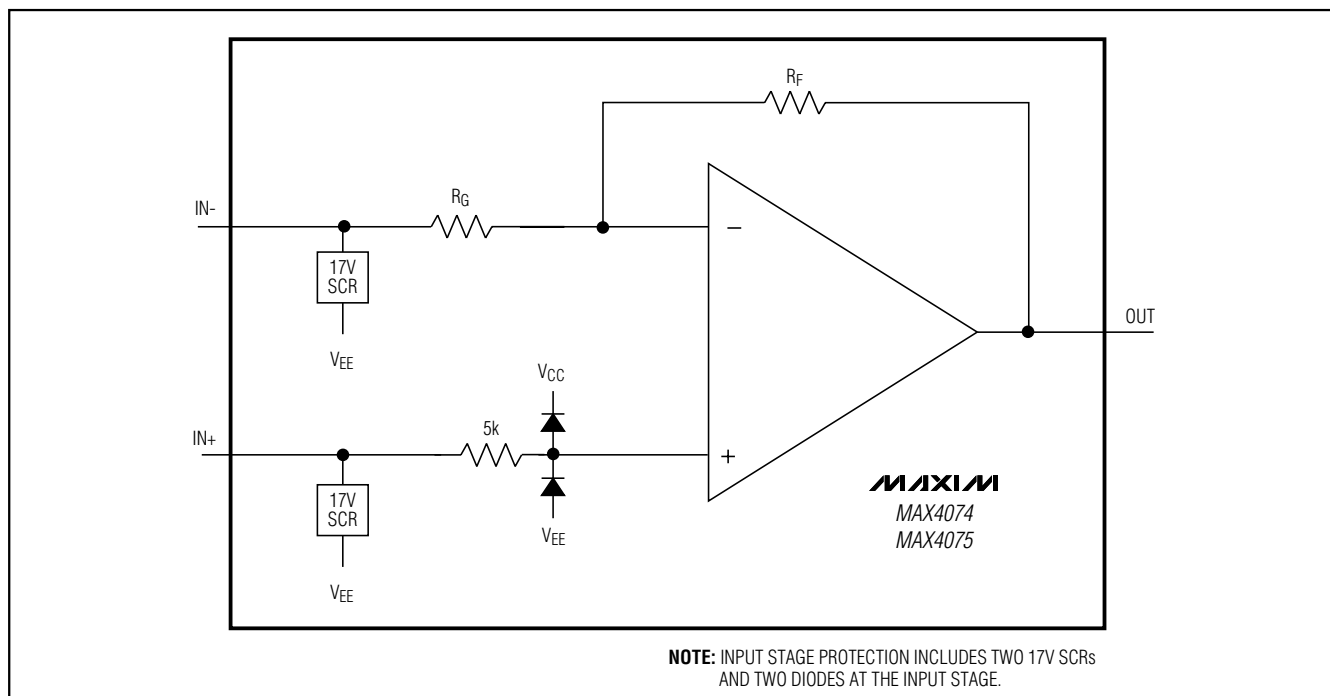

Figure 2. Input Protection

Micropower, SOT23, Rail-to-Rail, Fixed-Gain, GainAmp/Open-Loop Op Amps

MAX4074-MAX4078

GainAmp Signal Coupling and Configurations

Common op amp configurations include both noninverting and inverting amplifiers. Figures 3–6 show various single- and dual-supply circuit configurations. In single-supply systems, use a resistor-divider to bias the noninverting input. A lowpass filter capacitor from the op amp input to ground (Figure 5) prevents high-frequency power-supply noise from coupling into the op amp input. Dual-supply systems can have ground-referenced signals DC-coupled into the inverting or noninverting inputs.

Supply Bypassing and Board Layout

All devices in this GainAmp family operate from a +2.5V to +5.5V single supply or from $\pm 1.25V$ to $\pm 2.75V$ dual supplies. For single-supply operation, bypass the power supply with a 0.1 μF capacitor to ground. For dual supplies, bypass each supply to ground. Bypass with capacitors as close to the device as possible to minimize lead inductance and noise. A printed circuit board with a low-inductance ground plane is recommended.

Capacitive-Load Stability

Driving large capacitive loads can cause instability in most low-power, rail-to-rail output amplifiers. The fixed-gain amplifiers of this GainAmp family are stable with capacitive loads up to 100pF. Stability with higher capacitive loads can be improved by adding an isolation resistor in series with the op amp output, as shown in Figure 7. This resistor improves the circuit's phase margin by isolating the load capacitor from the amplifier's output. In Figure 8, a 220pF capacitor is driven with a 100 Ω isolation resistor exhibiting some overshoot but no oscillation. Figures 9 and 10 show the typical small-signal pulse responses of GainAmp fixed-gain amplifiers with 47pF and 100pF capacitive loads and no isolation resistor

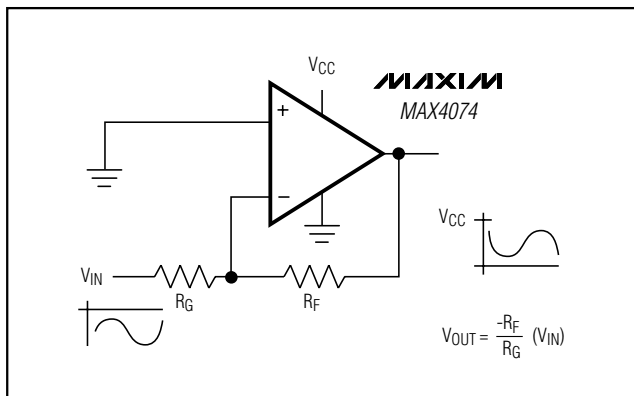

Figure 3. Single-Supply, DC-Coupled Inverting Amplifier with Negative Input Voltage

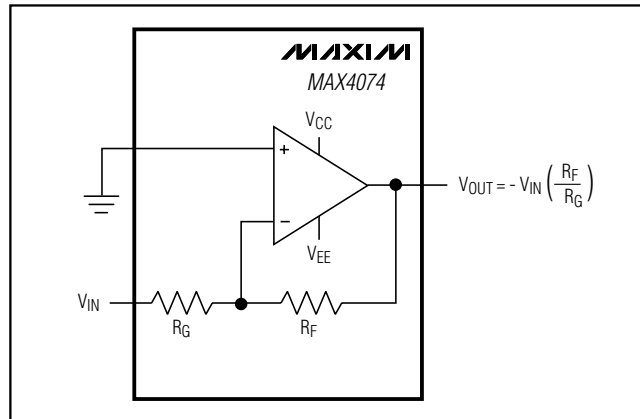

Figure 4. Dual-Supply, DC-Coupled Inverting Amplifier

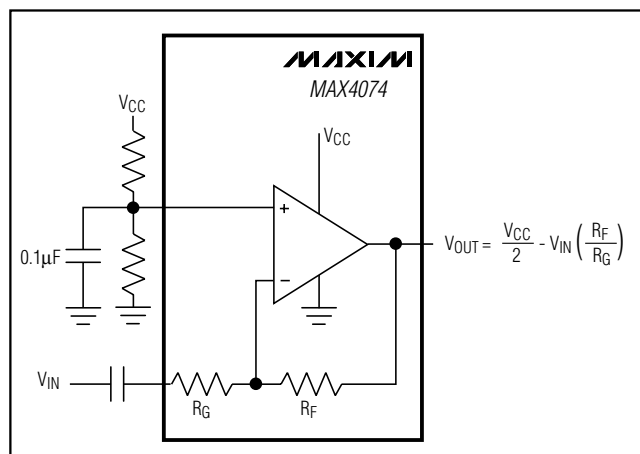

Figure 5. Single-Supply, AC-Coupled Inverting Amplifier

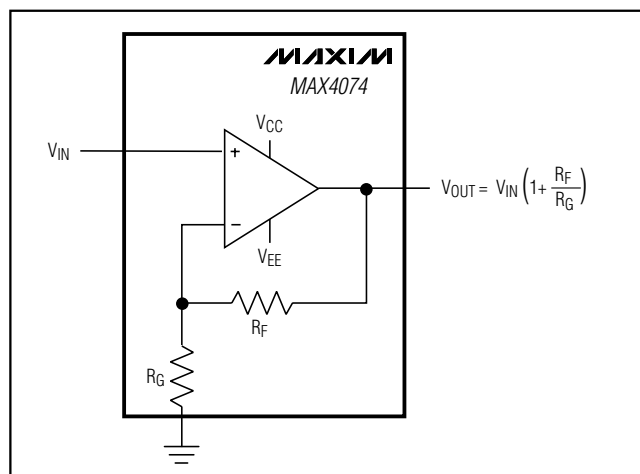

Figure 6. Dual-Supply, DC-Coupled Noninverting Amplifier

Micropower, SOT23, Rail-to-Rail, Fixed-Gain, GainAmp/Open-Loop Op Amps

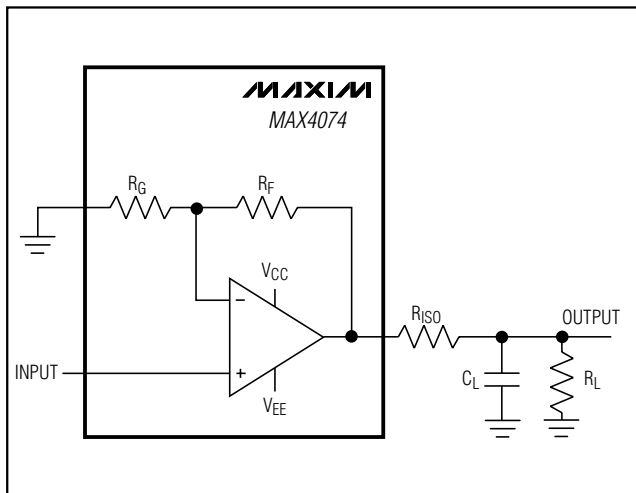

Figure 7. Dual-Supply, Capacitive-Load-Driving Circuit

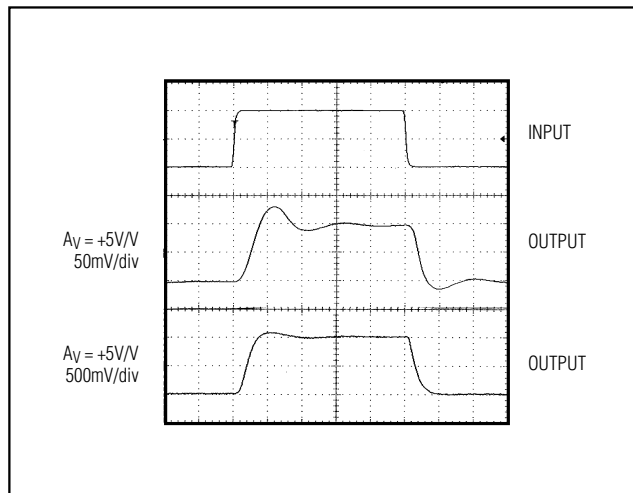

Figure 8. Small-Signal/Large-Signal Transient Response with Excessive Capacitive Load and Isolation Resistor

MAX4074-MAX4078

Micropower, SOT23, Rail-to-Rail, Fixed-Gain, GainAmp/Open-Loop Op Amps

MAX4074-MAX4078

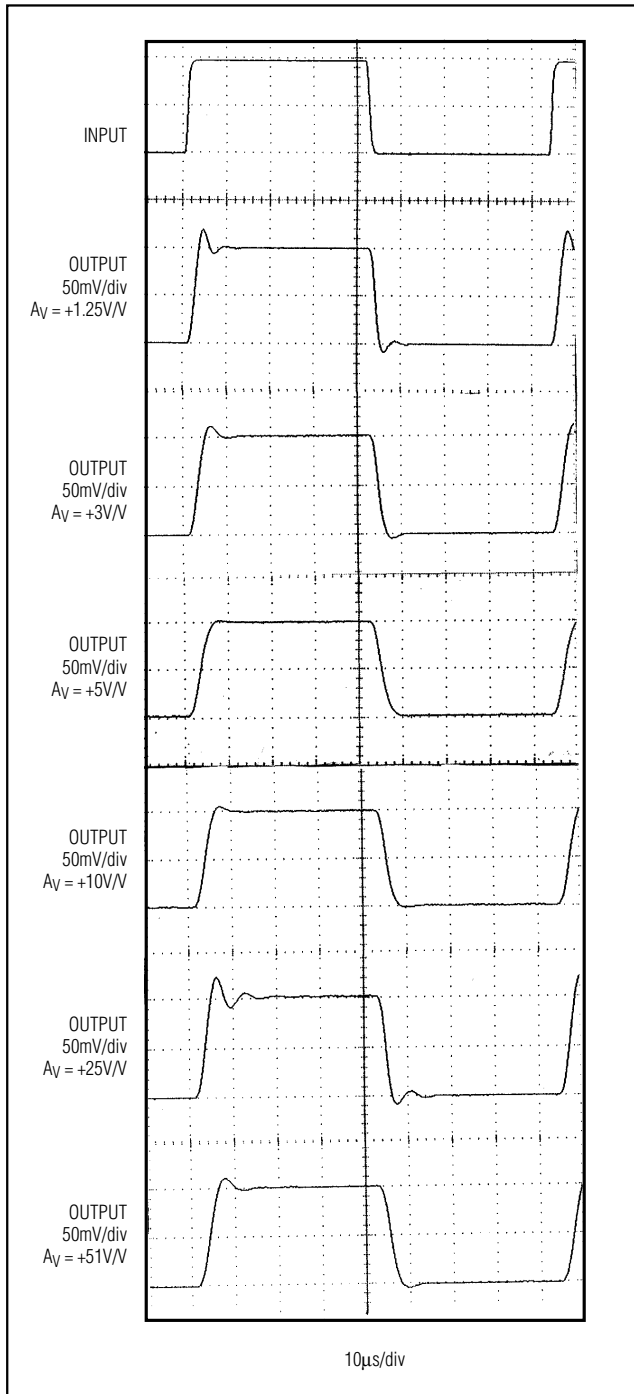

Figure 9. GainAmp Small-Signal Pulse Response ($C_L = 340\text{pF}$, $R_L = 100\text{k}\Omega$)

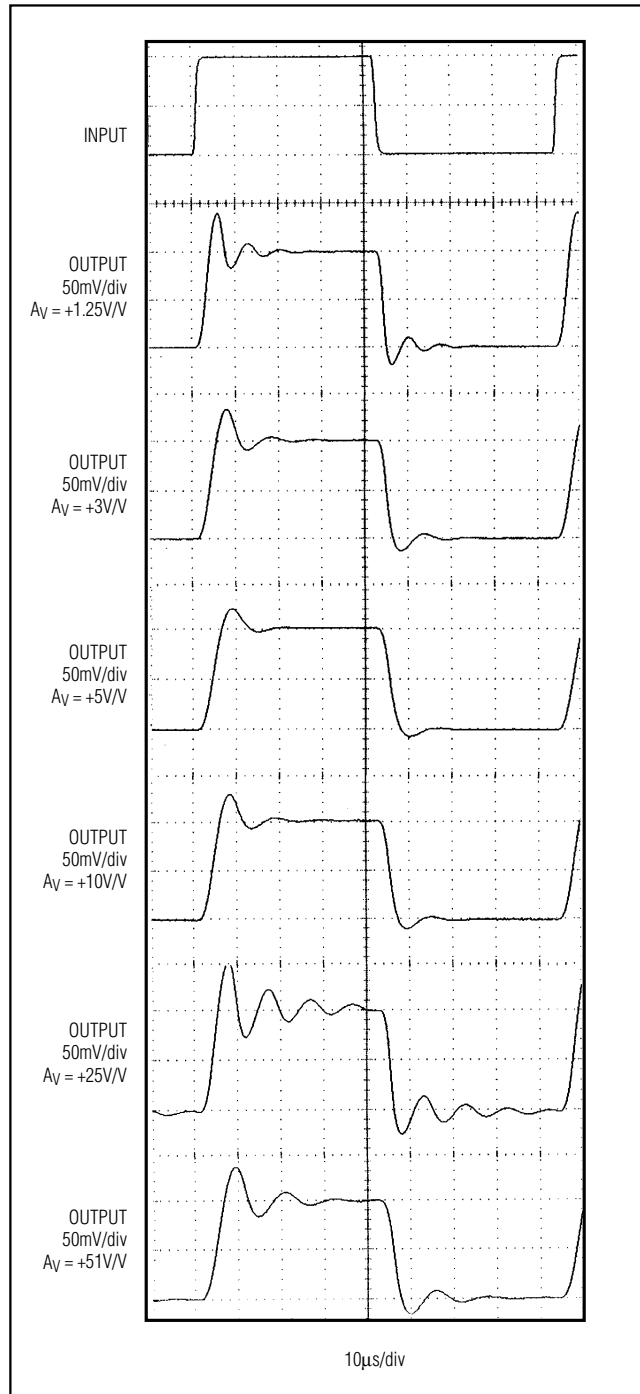

Figure 10. GainAmp Small-Signal Pulse Response ($C_L = 940\text{pF}$, $R_L = 100\text{k}\Omega$)

Micropower, SOT23, Rail-to-Rail, Fixed-Gain, GainAmp/Open-Loop Op Amps

Gain Selector Guide

MAX4074-MAX4078

GAIN CODE	INVERTING GAIN (V/V)	NONINVERTING GAIN (V/V)	-3dB BW (kHz)	TOP MARK
AB	0.25	1.25	200	ADJB
AC	0.5	1.5	136	ADJC
AD	1	2	102	ADJD
AE	1.25	2.25	70	ADJE
AF	1.5	2.5	180	ADJF
AG	2	3	135	ADJG
AH	2.5	3.5	116	ADJH
AJ	3	4	90	ADJI
AK	4	5	80	ADJJ
AL	5	6	71	ADJK
AM	6	7	61	ADJL
AN	8	9	50	ADJM
AO	9	10	90	ADJN
BA	10	11	79	ADJO
BB	12.5	13.5	64	ADJP
BC	15	16	54	ADJQ
BD	20	21	40	ADJR
BE	24	25	120	ADJS
BF	25	26	106	ADJT
BG	30	31	89	ADJU
BH	40	41	67	ADJV
BJ	49	50	50	ADJW
BK	50	51	82	ADJX
BL	60	61	66	ADJY
BM	79	80	50	ADJZ
BN	99	100	40	ADKA
CA	100	101	38	ADKB

Note: **Bold** indicates preferred gains. These gain versions are available as samples and in small quantities.

Micropower, SOT23, Rail-to-Rail, Fixed-Gain, GainAmp/Open-Loop Op Amps

Pin Configurations/Functional Diagrams

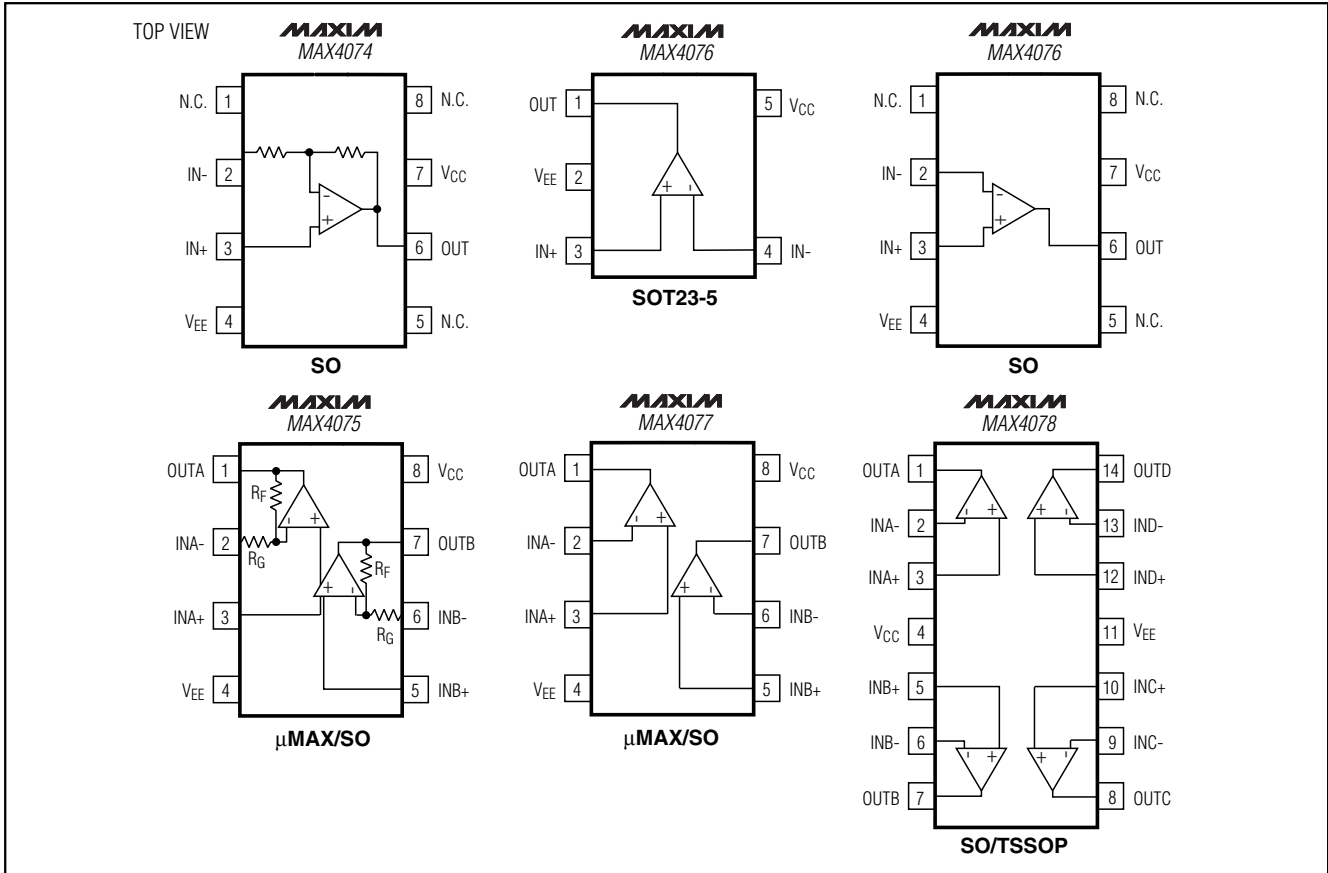

Micropower, SOT23, Rail-to-Rail, Fixed-Gain, GainAmp/Open-Loop Op Amps

Ordering Information (continued)

PART	TEMP. RANGE	PIN-PACKAGE	TOP MARK
MAX4075 __EUA	-40°C to +70°C	8 μ MAX	—
MAX4075__ESA	-40°C to +70°C	8 SO	—
MAX4076 EUK-T	-40°C to +70°C	5 SOT23-5	**
MAX4076ESA	-40°C to +70°C	8 SO	—
MAX4077 EUA	-40°C to +70°C	8 μ MAX	—
MAX4077ESA	-40°C to +70°C	8 SO	—
MAX4078 EUD	-40°C to +70°C	14 TSSOP	—
MAX4078ESD	-40°C to +70°C	14 SO	—

Note: Insert the desired gain code in the blank to complete the part number (see the Gain Selector Guide).

**See the Gain Selector Guide for a list of preferred gains and top marks.

Chip Information

TRANSISTOR COUNTS

MAX4074: 180	MAX4077: 340
MAX4075: 360	MAX4078: 332
MAX4076: 180	

Typical Operating Circuit

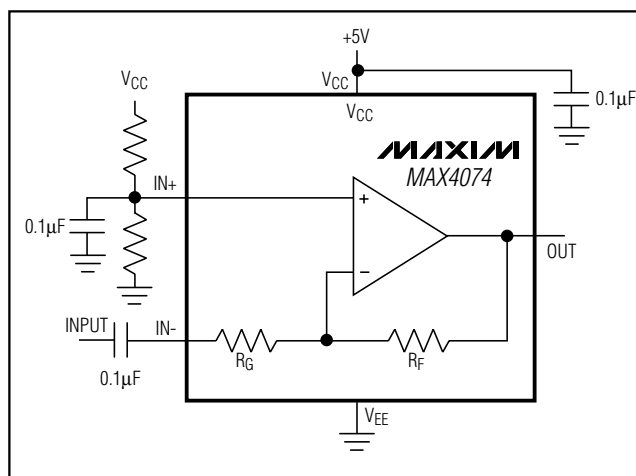

MAX4074-MAX4078

Micropower, SOT23, Rail-to-Rail, Fixed-Gain, GainAmp/Open-Loop Op Amps

Package Information

MAX4074-MAX4078

SYMBOL	MIN	MAX
A	0.90	1.45
A1	0.00	0.15
A2	0.90	1.30
b	0.35	0.50
C	0.08	0.20
D	2.80	3.00
E	2.60	3.00
E1	1.50	1.75
L	0.35	0.55
e	0.95 REF	
e1	1.90 REF	
α	0°	10°

NOTE:

1. ALL DIMENSIONS ARE IN MILLIMETERS.
2. FOOT LENGTH MEASURED AT INTERCEPT POINT BETWEEN DATUM A & LEAD SURFACE.
3. PACKAGE OUTLINE EXCLUSIVE OF MOLD FLASH & METAL BURR.
4. PACKAGE OUTLINE INCLUSIVE OF SOLDER PLATING.

MAXIM		
<small>PROPRIETARY INFORMATION</small>		
<small>TITLE:</small>		
PACKAGE OUTLINE, SOT23, 5L		
<small>APPROVAL</small>	<small>DOCUMENT CONTROL NO.</small>	<small>REV</small>
	21-0057	B 1/1

SOT23LEPS

Micropower, SOT23, Rail-to-Rail, Fixed-Gain, GainAmp/Open-Loop Op Amps

Package Information (continued)

MAX4074-MAX4078

COMMON DIMENSIONS				
DIMENSION	MILLIMETERS		INCHES	
	MIN.	MAX.	MIN.	MAX.
A	0.05	0.15	.002	.006
A ₁	0.85	0.95	.033	.037
b	0.19	0.30	.007	.012
bl	0.19	0.25	.007	.010
c	0.090	0.20	.0035	.008
c ₁	0.090	0.135	.0035	.0053
D	SEE VARIATIONS		SEE VARIATIONS	
E	4.30	4.50	.169	.177
e	0.65 BSC		.026 BSC	
H	6.25	6.50	.246	.256
L	0.50	0.70	.020	.028
N	SEE VARIATIONS		SEE VARIATIONS	
Y	2.85	3.15	.112	.124
α	0°	8°	0°	8°

JEDEC	N	VARIATIONS			
		MILLIMETERS		INCHES	
		MIN.	MAX.	MIN.	MAX.
AB	14	4.90	5.10	.193	.201
AC	16	4.90	5.10	.193	.201
AC-EP	16	4.90	5.10	.193	.201
	X	2.85	3.15	.112	.124
AD	20	6.40	6.60	.252	.260
AD-EP	20	6.40	6.60	.252	.260
	X	4.00	4.34	.157	.171
AE	24	7.70	7.90	.303	.311
AF	28	9.60	9.80	.378	.386
AF-EP	D	9.60	9.80	.378	.386
	X	5.35	5.65	.211	.222

NOTES:
 1. DIMENSIONS D AND E DO NOT INCLUDE FLASH.
 2. MOLD FLASH OR PROTRUSIONS NOT TO EXCEED .15 mm PER SIDE.
 3. CONTROLLING DIMENSION: MILLIMETER.
 4. MEETS JEDEC OUTLINE MD-153 VARIATIONS AB, AC, AD, AE, AF.
 5. DIMENSIONS X AND Y APPLY TO EXPOSED PAD (EP) VERSIONS ONLY.
 6. EXPOSED PAD FLUSH WITH BOTTOM OF PACKAGE WITHIN .002".

MAXIM
 PROPRIETARY INFORMATION
 TITLE: PACKAGE OUTLINE, TSSOP, 4.40mm BODY, 0.65mm PITCH
 APPROVAL: _____ DOCUMENT CONTROL NO: 21-0066 REV: C 1/1

MAX4074-MAX4078

Micropower, SOT23, Rail-to-Rail, Fixed-Gain, GainAmp/Open-Loop Op Amps

Package Information (continued)

	INCHES		MILLIMETERS		JEDEC			
	MIN	MAX	MIN	MAX	MIN	MAX	MIN	MAX
A	0.037	0.043	0.94	1.10	---	0.043	---	1.10
A1	0.002	0.006	0.05	0.15	0.002	0.006	0.05	0.15
B	0.010	0.014	0.25	0.36	0.010	0.016	0.25	0.40
C	0.005	0.007	0.13	0.18	0.005	0.009	0.13	0.23
D	0.116	0.120	2.95	3.05	0.114	0.122	2.9	3.1
e	0.0256 BSC		0.65 BSC		0.0256 BSC		0.64 BSC	
E	0.116	0.120	2.95	3.05	0.114	0.122	2.9	3.1
H	0.188	0.198	4.78	5.03	0.193 BSC		4.9 BSC	
L	0.016	0.026	0.41	0.66	0.016	0.027	0.40	0.70
α	0°	6°	0°	6°	0°	6°	0°	6°
*X	0.087	0.099	2.210	2.515				
*Y	0.062	0.074	1.575	1.880				

* EXPOSED PAD (Note 5)

NOTES:
 1. D&E DO NOT INCLUDE MOLD FLASH.
 2. MOLD FLASH OR PROTRUSIONS NOT TO EXCEED .15 MM (.006").
 3. CONTROLLING DIMENSION: MILLIMETERS.
 4. MEETS JEDEC MO-187.
 5. DIMENSIONS X & Y APPLY TO EXPOSED PAD (EP) VERSIONS ONLY. SEE INDIVIDUAL PRODUCT DATASHEET TO DETERMINE IF A PRODUCT USES EXPOSED PAD PACKAGE.
 6. EXPOSED PAD FLUSH WITH BOTTOM OF PACKAGE WITHIN .002".

MAXIM
 PROPRIETARY INFORMATION
 TITLE: PACKAGE OUTLINE, 8L UMXX WITH EP OPTION
 APPROVAL: 21-0036
 DOCUMENT CONTROL: H
 REV: 1/1

	INCHES		MILLIMETERS		N	MS012
	MIN	MAX	MIN	MAX		
A	0.053	0.069	1.35	1.75	8	A
A1	0.004	0.010	0.10	0.25		
B	0.014	0.019	0.35	0.49		
C	0.007	0.010	0.19	0.25		
e	0.050		1.27			
E	0.150	0.157	3.80	4.00		
H	0.228	0.244	5.80	6.20		
h	0.010	0.020	0.25	0.50		
L	0.016	0.050	0.40	1.27		

	INCHES		MILLIMETERS		N	MS012
	MIN	MAX	MIN	MAX		
D	0.189	0.197	4.80	5.00	8	A
D	0.337	0.344	8.55	8.75	14	B
D	0.386	0.394	9.80	10.00	16	C

NOTES:
 1. D&E DO NOT INCLUDE MOLD FLASH.
 2. MOLD FLASH OR PROTRUSIONS NOT TO EXCEED .15mm (.006").
 3. LEADS TO BE COPLANAR WITHIN .102mm (.004").
 4. CONTROLLING DIMENSION: MILLIMETER.
 5. MEETS JEDEC MS012-XX AS SHOWN IN ABOVE TABLE.
 6. N = NUMBER OF PINS.

MAXIM
 PROPRIETARY INFORMATION
 TITLE: PACKAGE FAMILY OUTLINE: SOIC .150
 APPROVAL: 21-0041 A
 DOCUMENT CONTROL: H
 REV: 1/1

Maxim cannot assume responsibility for use of any circuitry other than circuitry entirely embodied in a Maxim product. No circuit patent licenses are implied. Maxim reserves the right to change the circuitry and specifications without notice at any time.

20 Maxim Integrated Products, 120 San Gabriel Drive, Sunnyvale, CA 94086 408-737-7600

OUR CERTIFICATE

DiGi provide top-quality products and perfect service for customer worldwide through standardization, technological innovation and continuous improvement. DiGi through third-party certification, we stricly control the quality of products and services. Welcome your RFQ to

Email: Info@DiGi-Electronics.com



Tel: +00 852-30501935

RFQ Email: Info@DiGi-Electronics.com

DiGi is a global authorized distributor of electronic components.