

MAX6329ZLUT+T Datasheet

www.digi-electronics.com

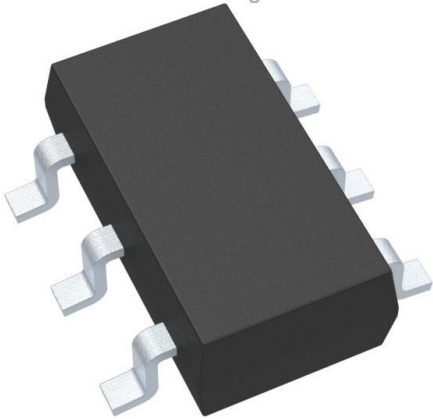

<https://www.DiGi-Electronics.com>

DiGi Electronics Part Number	MAX6329ZLUT+T-DG
Manufacturer	Analog Devices Inc./Maxim Integrated
Manufacturer Product Number	MAX6329ZLUT+T
Description	IC REG LDO 2.5V/ADJ SOT23-6
Detailed Description	Linear Voltage Regulator IC Positive Adjustable (Fixed) 1 Output 150mA SOT-23-6



Tel: +00 852-30501935

RFQ Email: Info@DiGi-Electronics.com

DiGi is a global authorized distributor of electronic components.

Purchase and inquiry

Manufacturer Product Number:

MAX6329ZLUT+T

Series:

-

Output Configuration:

Positive

Number of Regulators:

1

Voltage - Output (Min/Fixed):

1.23V (2.5V)

Voltage Dropout (Max):

0.4V @ 150mA

Current - Quiescent (Iq):

50 μ A

Control Features:

Enable, Reset

Operating Temperature:

0°C ~ 85°C (TA)

Package / Case:

SOT-23-6

Base Product Number:

MAX6329

Manufacturer:

Analog Devices Inc./Maxim Integrated

Product Status:

Active

Output Type:

Adjustable (Fixed)

Voltage - Input (Max):

5.5V

Voltage - Output (Max):

5V

Current - Output:

150mA

PSRR:

-

Protection Features:

Over Temperature, Short Circuit

Mounting Type:

Surface Mount

Supplier Device Package:

SOT-23-6

Environmental & Export classification

RoHS Status:

ROHS3 Compliant

REACH Status:

REACH Unaffected

HTSUS:

8542.39.0001

Moisture Sensitivity Level (MSL):

1 (Unlimited)

ECCN:

EAR99



150mA, SOT23, Low-Dropout Linear Regulators with Internal Microprocessor Reset Circuit

General Description

The MAX6329/MAX6349 are low-dropout, micropower linear voltage regulators with integrated microprocessor reset circuits. Each is available with preset +3.3V, +2.5V, +1.8V, or adjustable output voltages and can deliver up to 150mA load current. Employing internal P-channel MOSFET pass transistors, the devices consume only 25 μ A supply current, independent of the device load. The low supply current, low dropout voltage, and integrated reset functionality make these devices ideal for battery powered portable equipment.

The MAX6329/MAX6349 include an internal reset circuit that indicates when the regulator output drops below standard microprocessor supply tolerances (-5% or -10%). The reset output remains asserted for 100ms (min) after the regulator output exceeds the selected reset threshold, ensuring that supply voltages and clock oscillators have stabilized before processor activity is enabled. Reset outputs are available in push-pull (active-low or -high) and open-drain (active-low) options. The internal reset circuit replaces external microprocessor supervisors or RC-based reset time delays.

The MAX6329/MAX6349 are optimized for use with a 1 μ F (min) output capacitor. The regulator output voltage is adjustable with an external resistor-divider network at SET (reset threshold voltages track the desired output voltage). Each device includes thermal shutdown protection, output short-circuit protection, and reverse leakage protection. The MAX6329 includes a shutdown feature to reduce regulator current below 1 μ A (max) and the MAX6349 offers a manual reset input to assert a microprocessor reset while the regulator output is within specification.

Applications

Hand-Held Instruments
Electronic Planners
Palm Top Computers
PCMCIA Cards
USB Devices
Cellular Telephones
Cordless Telephones
Modems

Selector Guide appears at end of data sheet.

Typical Operating Circuit appears at end of data sheet.

Features

- ◆ Preset +3.3V/+2.5V/+1.8V or Adjustable Regulator Output
- ◆ $\pm 3.0\%$ Regulator Accuracy Over the Specified Operating Range
- ◆ 25 μ A Supply Current
- ◆ Low 180mV Dropout at 100mA Load
- ◆ Small Output Capacitor (1 μ F min ceramic or tantalum)
- ◆ Zero Reverse Leakage Current
- ◆ Thermal and Short-Circuit Protection
- ◆ Integrated Microprocessor Reset Circuit with 100ms (min) Timeout
- ◆ Open-Drain and Push-Pull Reset Outputs
- ◆ Regulator Shutdown Input (MAX6329) or Manual Reset Input (MAX6349)
- ◆ 6-Pin SOT23 Package

Ordering Information

PART	TEMP RANGE	PIN-PACKAGE
MAX6329__ UT-T	0°C to +85°C	6 SOT23-6
MAX6349__ UT-T	0°C to +85°C	6 SOT23-6

These parts offer a choice of regulator/reset voltages and reset outputs. From the Selector Guide, insert the desired suffix letters into the blanks to complete the part number. Each device is available in nine standard versions. Sample stock is generally held on standard versions only (see Standard Versions table). Standard versions have an order increment requirement of 2500 pieces. Nonstandard versions have an order increment requirement of 10,000 pieces. Contact factory for availability of nonstandard versions.

Pin Configuration

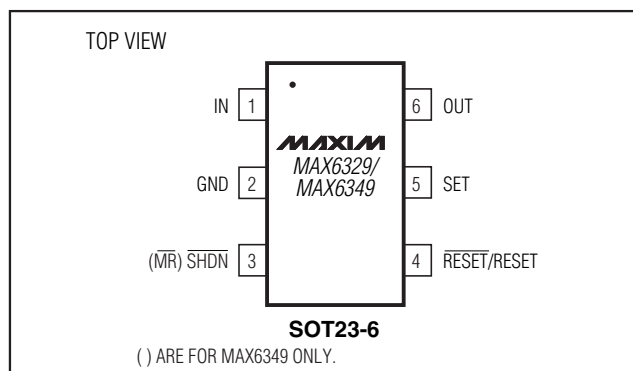

150mA, SOT23, Low Dropout Linear Regulators with Internal Microprocessor Reset Circuit

MAX6329/MAX6349

ABSOLUTE MAXIMUM RATINGS

IN to GND	-0.3V to +7V
SHDN to GND	-0.3V to +7V
SET to GND	-0.3V to (V _{OUT} + 0.3V)
MR to GND	-0.3V to +7V
RESET, $\overline{\text{RESET}}$ to GND, (Push-Pull)	0.3V to (V _{OUT} + 0.3V)
RESET to GND, (Open-Drain)	-0.3V to (V _{OUT} + 0.3V)
OUT to GND	-0.3V to +7V
Short-Circuit Duration	Continuous
Maximum Current into Any Pin (except IN, OUT)	±20mA

Continuous Power Dissipation (T _A = +70°C)	
6-Pin SOT23 (derate 7.1mW/°C above +70°C)	571mW
Thermal Resistance (θ _{JA})	+140°C/W
Operating Temperature Range	0°C to +85°C
Junction Temperature	+150°C
Storage Temperature Range	-65°C to +150°C
Lead Temperature (soldering, 10s)	+300°C

Stresses beyond those listed under "Absolute Maximum Ratings" may cause permanent damage to the device. These are stress ratings only, and functional operation of the device at these or any other conditions beyond those indicated in the operational sections of the specifications is not implied. Exposure to absolute maximum rating conditions for extended periods may affect device reliability.

ELECTRICAL CHARACTERISTICS

(V_{IN} = +3.6V, T_A = 0°C to +85°C. Typical values are at I_{OUT} = 0, C_{OUT} = 2.2μF, T_A = +25°C, unless otherwise noted.) (Note 1)

PARAMETER	SYMBOL	CONDITIONS	MIN	TYP	MAX	UNITS
Input Voltage Range	V _{IN}		2.5		5.5	V
Supply Current	I _Q	At GND		25	50	μA
Shutdown Supply Current		T _A = +25°C			1	μA
REGULATOR						
Maximum Output Current			150			mA
Output Voltage (Note 2)	V _{OUT}	V _{IN} = 4.0V to 5.5V, SET = GND, I _{OUT} = 0 to 100mA, T/S Versions	3.20	3.3	3.40	V
		V _{IN} = 3.0V to 5.5V, SET = GND, I _{OUT} = 0 to 100mA, Z/Y Versions	2.425	2.5	2.575	
		V _{IN} = 2.5V to 5.5V, SET = GND, I _{OUT} = 0 to 100mA, W/V Versions	1.745	1.8	1.855	
Dropout Voltage (Note 3)	ΔV _{DO}	I _{LOAD} = 10mA, T/S Versions		20	30	mV
		I _{LOAD} = 150mA, T/S Versions		300	360	
		I _{LOAD} = 10mA, Z/Y Versions		25	35	
		I _{LOAD} = 150mA, Z/Y Versions		300	400	
		I _{LOAD} = 10mA, W/V Versions		60	200	
		I _{LOAD} = 150mA, W/V Versions		600	750	
Output Current Limit		V _{IN} = V _{OUT} + 1V		350		mA
Input Reverse Leakage Current		V _{IN} = 0, V _{OUT} = 5.5V		0.01	1.5	μA
Startup-Time Response		Rising edge of V _{IN} or $\overline{\text{SHDN}}$ to V _{OUT} R _L = 68Ω, SET = GND, C _L = 1μF		500		μs
$\overline{\text{SHDN}}$ Input Voltage	V _{IL}	MAX6329 only	0.3 × V _{IN}			V
	V _{IH}		0.8 × V _{IN}			
$\overline{\text{SHDN}}$ Input Current	I _{SHDN}	$\overline{\text{SHDN}}$ = GND or IN MAX6329 only	-1	0.1	1	μA
SET Reference Voltage	V _{SET}		1.20	1.23	1.26	V
SET Input Leakage Current	I _{SET}		-10		+10	nA
Thermal Shutdown Temperature				160		°C
Thermal Shutdown Hysteresis				20		°C

150mA, SOT23, Low Dropout Linear Regulators with Internal Microprocessor Reset Circuit

ELECTRICAL CHARACTERISTICS (continued)

($V_{IN} = +3.6V$, $T_A = -0^{\circ}C$ to $+85^{\circ}C$. Typical values are at $I_{OUT} = 0$, $C_{OUT} = 2.2\mu F$, $T_A = +25^{\circ}C$, unless otherwise noted.) (Note 1)

PARAMETER	SYMBOL	CONDITIONS	MIN	TYP	MAX	UNITS	
RESET CIRCUIT							
Reset Threshold (Note 2)	V_{TH}	MAX63_9T SET = GND	2.92		3.185	V	
		MAX63_9S SET = GND	2.75		3.02		
		MAX63_9Z SET = GND	2.21		2.41		
		MAX63_9Y SET = GND	2.08		2.28		
		MAX63_9W SET = GND	1.59		1.74		
		MAX63_9V SET = GND	1.50		1.65		
		MAX63_9T/Z/W SET = divider, Figure 1 (Note 4)	$0.885 \times V_{ADJ}$	$0.965 \times V_{ADJ}$			
		MAX63_9S/Y/V SET = divider, Figure 1 (Note 4)	$0.835 \times V_{ADJ}$	$0.915 \times V_{ADJ}$			
Reset Timeout Period	t_{RP}		100	200	300	ms	
V_{OUT} to Reset Delay	t_{RD}			35		μs	
\overline{MR} Input Voltage	V_{IL}	MAX6349 only	$0.2 \times V_{OUT}$			V	
	V_{IH}		$0.8 \times V_{OUT}$				
\overline{MR} Minimum Input Pulse		MAX6349 only	1			μs	
\overline{MR} Glitch Rejection		MAX6349 only		120		ns	
\overline{MR} to Reset Delay		MAX6349 only		500		ns	
\overline{MR} Pullup Resistance		MAX6349 only	10	20	50	$k\Omega$	
Open-Drain \overline{RESET} Output Voltage	V_{OL}	$V_{OUT} \geq 1.0V$, $I_{SINK} = 50\mu A$			0.3	V	
		$V_{OUT} \geq 2.7V$, $I_{SINK} = 3.2mA$			0.4		
Open-Drain Reset Output Leakage Current	I_{LKG}				1.0	μA	
Push-Pull \overline{RESET} Output Voltage	V_{OL}	$V_{OUT} \geq 1.0V$, $I_{SINK} = 50\mu A$			0.3	V	
		$V_{OUT} < V_{TH}(\min)$, $I_{SINK} = 3.2mA$			0.4		
	V_{OH}	$V_{OUT} > V_{TH}(\max)$, $I_{SOURCE} = 500\mu A$	$0.8 \times V_{OUT}$				
Push-Pull \overline{RESET} Output Voltage	V_{OL}	$V_{OUT} > V_{TH}(\max)$, $I_{SINK} = 3.2mA$			0.4	V	
	V_{OH}	$V_{OUT} < V_{TH}$, $I_{SOURCE} = 150\mu A$	$0.8 \times V_{OUT}$				

Note 1: Limits over temperature are guaranteed by design and not production tested.

Note 2: Specification from $0^{\circ}C$ to less than $25^{\circ}C$ is guaranteed to four sigma only.

Note 3: Dropout voltage is defined as $V_{IN} - V_{OUT}$ when V_{OUT} is 2% below the value of V_{OUT} for $V_{IN} = V_{OUT} + 1V$.

Note 4: $V_{ADJ} = V_{SET}(1 + R1/R2)$, where $V_{SET} = 1.23V$ nominal.

MAX6329/MAX6349

150mA, SOT23, Low Dropout Linear Regulators with Internal Microprocessor Reset Circuit

Typical Operating Characteristics

($T_A = +25^\circ\text{C}$, unless otherwise noted.)

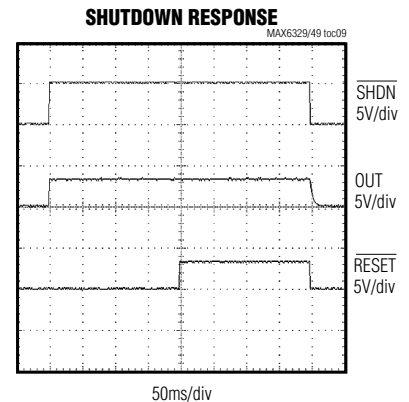
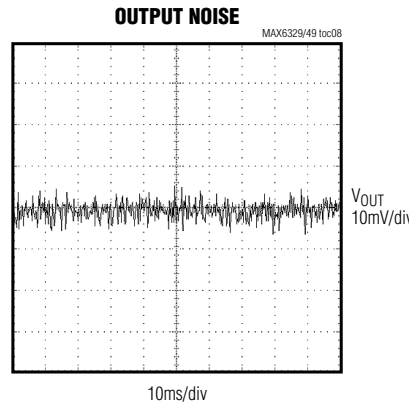
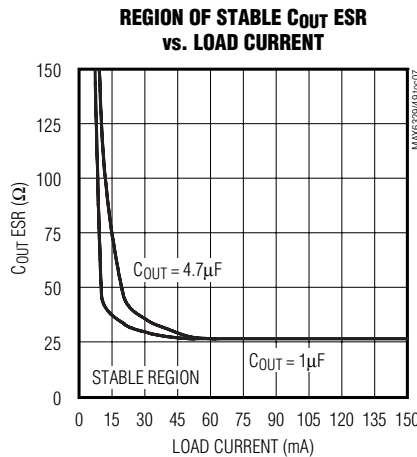
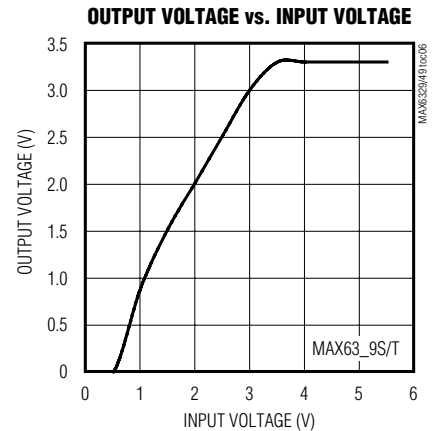
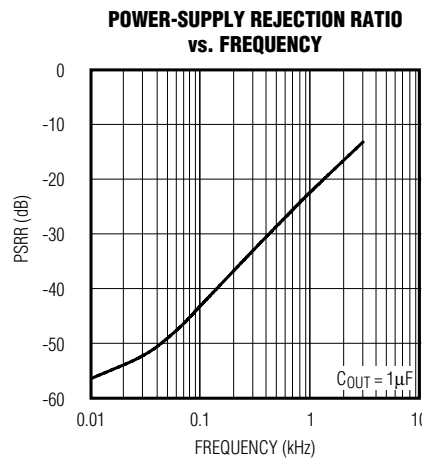
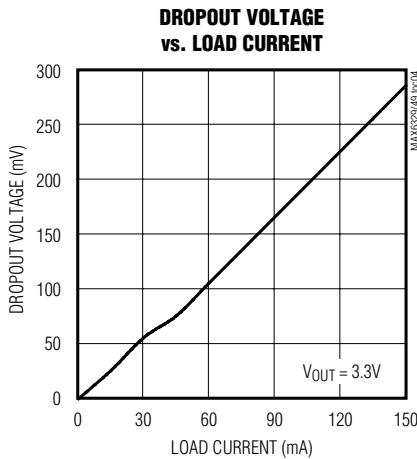
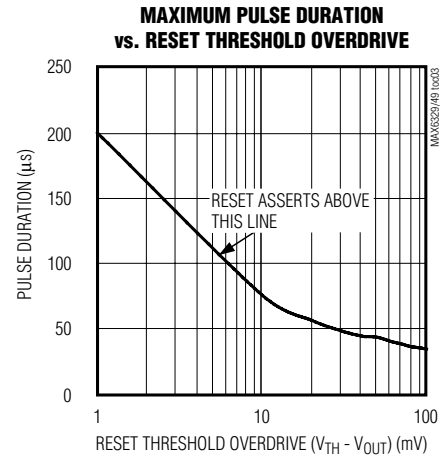
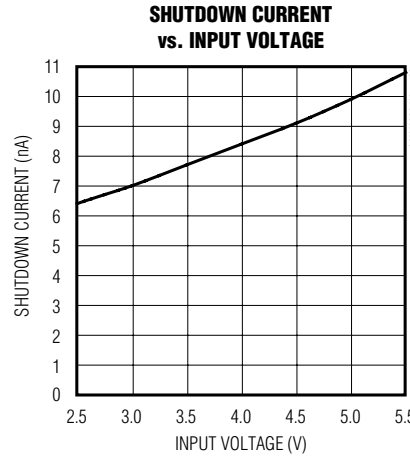
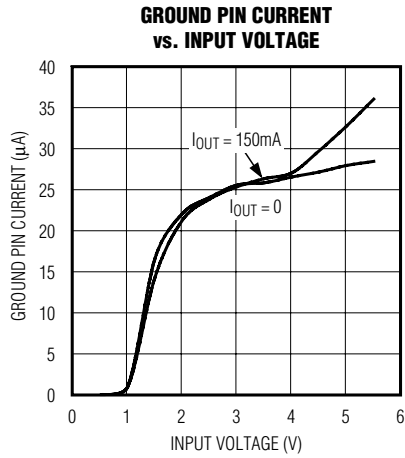

150mA, SOT23, Low Dropout Linear Regulators with Internal Microprocessor Reset Circuit

Typical Operating Characteristics (continued)

($T_A = +25^\circ\text{C}$, unless otherwise noted.)

MAX6329/MAX6349

STARTUP RESPONSE

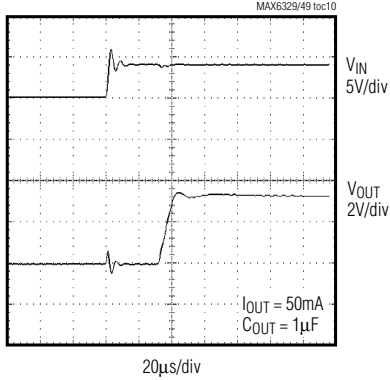

LOAD TRANSIENT RESPONSE

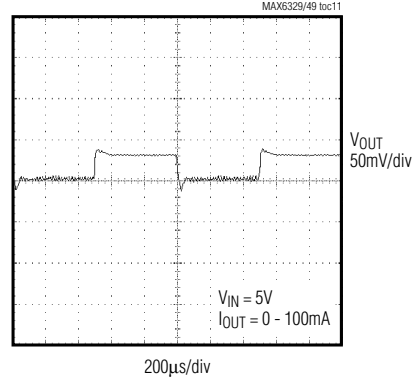

LOAD TRANSIENT RESPONSE NEAR DROPOUT

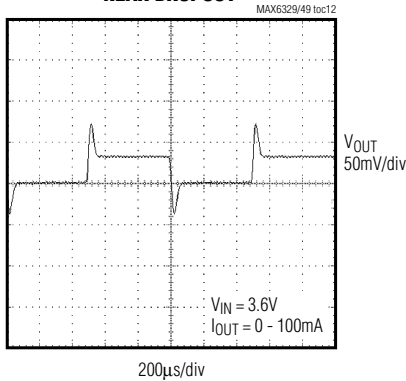

LINE TRANSIENT

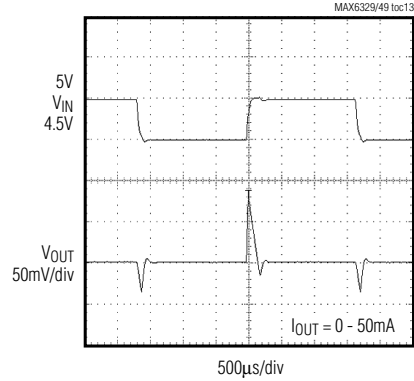

150mA, SOT23, Low Dropout Linear Regulators with Internal Microprocessor Reset Circuit

MAX6329/MAX6349

Pin Description

PIN	NAME	DESCRIPTION
1	IN	Regulator Input. Supply voltage can range from +2.5V to +5.5V.
2	GND	Ground. This pin also functions as a heatsink. Solder to large pads or the circuit board ground plane to maximize thermal dissipation.
3	$\overline{\text{SHDN}}$	(MAX6329 Only) Active-Low Shutdown Input. A logic low reduces the supply current to $< 1\mu\text{A}$. Connect
	$\overline{\text{MR}}$	(MAX6349 Only) Active-Low Manual Reset Input. A logic low forces a reset. Reset remains asserted for the duration of the reset timeout period after $\overline{\text{MR}}$ transitions from low to high. Leave unconnected or connect to V_{OUT} if not used. $\overline{\text{MR}}$ has an internal pullup resistor of $20\text{k}\Omega$ (typ) to OUT.
4	$\overline{\text{RESET}}$	Active-Low Reset Output. $\overline{\text{RESET}}$ remains low while V_{OUT} is below the reset threshold or while $\overline{\text{MR}}$ is held low. $\overline{\text{RESET}}$ remains low for the duration of the reset timeout period after the reset conditions are terminated.
	RESET	Active-High Reset Output. RESET remains high while V_{OUT} is below the reset threshold or while $\overline{\text{MR}}$ is held low. RESET remains high for the duration of the reset timeout period after the reset conditions are terminated.
5	SET	Feedback Input for Setting the Output Voltage. Connect to GND to set the output voltage to the preset fixed value (+3.3V, +2.5V, or +1.8V). Connect to an external resistor-divider network for adjustable output operation.
6	OUT	Regulator Output. Fixed (+3.3V, +2.5V, or +1.8V) or adjustable (+1.23V to +5.0V). Sources up to 150mA. Bypass with a $1\mu\text{F}$ minimum capacitor for full rated performance.

Detailed Description

The MAX6329/MAX6349 are low-dropout, low-quiescent current linear regulators with integrated microprocessor reset circuits. The devices drive loads up to 150mA and are available with preset output voltages of +3.3V, +2.5V, or +1.8V. The internal reset circuit monitors the regulator output voltage and asserts the reset output when the regulator output is below the microprocessor supply tolerance.

Regulator

The regulator core operates with an input voltage range of +2.5V to +5.5V. The output voltage is offered with three fixed voltage options (+3.3V, +2.5V, and +1.8V) for the MAX6329 and MAX6349. Enable the fixed voltage output by connecting SET to ground. The MAX6329/MAX6349 offer an adjustable output voltage that is implemented with an external resistor-divider network connected to OUT, SET, and GND (Figure 1). SET must be connected to either GND or the external divider. The MAX6329/MAX6349 automatically determine the feedback path depending on the voltage seen at SET. Featured characteristics include ultra-low quiescent current and low dropout voltage. The *Typical Operating Circuit* shows a typical connection for the MAX6329.

OUT is an internally regulated low dropout (LDO) linear regulator that powers a microprocessor.

Reset Circuit

The reset supervisor circuit is fully integrated in the MAX6329/MAX6349 and uses the same reference voltage as the regulator. Two supply tolerance reset thresholds, -5% and -10%, are provided for each type of device:

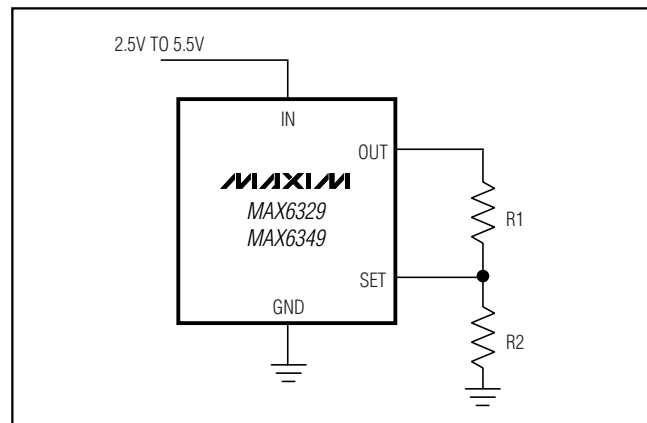

Figure 1. Adjustable Output Voltage Configuration

150mA, SOT23, Low Dropout Linear Regulators with Internal Microprocessor Reset Circuit

MAX6329/MAX6349

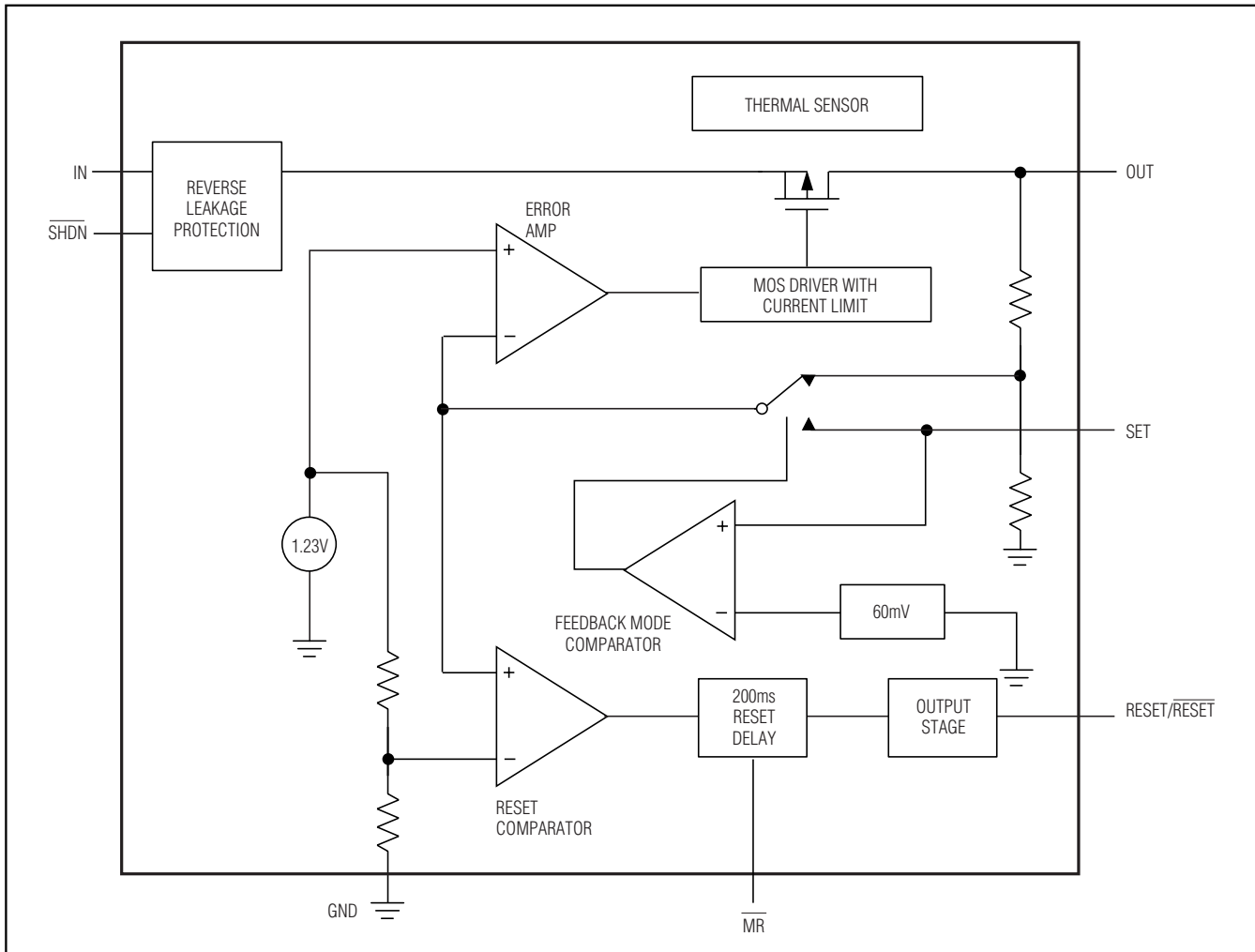

Figure 2. Functional Diagram

5% reset: Reset does not assert until the regulator output voltage is at least -5% out of tolerance and always asserts before the regulator output voltage is -10% out of tolerance.

10% reset: Reset does not assert until the regulator output voltage is at least -10% out of tolerance and always asserts before the regulator output voltage is -15% out of tolerance.

Reset Output

A μP 's reset input starts the μP in a known state. The MAX6329/MAX6349 μP supervisory circuits assert a reset during power-up, power-down, and brownout conditions. Reset is guaranteed to be logic high or low depending on the device chosen (see *Selector Guide*). RESET or $\overline{\text{RESET}}$ asserts when V_{OUT} is below the reset

threshold and for at least 100ms (t_{RP}) after V_{OUT} rises above the reset threshold. RESET or $\overline{\text{RESET}}$ also asserts when $\overline{\text{MR}}$ is low (MAX6349).

Shutdown (MAX6329 Only)

$\overline{\text{SHDN}}$ allows for the regulator to shutdown thereby reducing the total I_{IN} consumption of the device. The MAX6329 provides a digitally controlled active-low shutdown function. In shutdown mode the pass transistor, control circuit, reference, and all biases turn off, reducing the supply current to below $1\mu\text{A}$. Connect $\overline{\text{SHDN}}$ to IN for normal operation.

Manual Reset Input (MAX6349 Only)

Many μP -based products require manual reset capability, allowing the operator, a test technician, or external logic circuitry to initiate a reset. For the MAX6349, a

150mA, SOT23, Low Dropout Linear Regulators with Internal Microprocessor Reset Circuit

MAX6329/MAX6349

logic low on \overline{MR} asserts reset while the regulator is still within tolerance.

Reset remains asserted while \overline{MR} is low and for the reset timeout period (100ms min) after \overline{MR} returns high. The \overline{MR} input has an internal pullup of 20k Ω (typ) to OUT. This input can be driven with TTL/CMOS logic levels or with open-drain/collector outputs. Connect a normally open momentary switch from \overline{MR} to GND to create a manual reset function; external debounce circuitry is not required. If \overline{MR} is driven from long cables or the device is used in a noisy environment, connect a 0.1 μ F capacitor from \overline{MR} to GND to provide additional noise immunity.

Reverse Leakage Protection

An internal circuit monitors the input and output voltages. When the output voltage is greater than the input voltage, the internal pass transistor and parasitic diodes turn off. OUT powers the device. There is no leakage path from OUT to IN. Therefore, the output can be powered from an auxiliary supply such as a backup battery without any need for additional blocking diodes.

Current Limit

The MAX6329/MAX6349 include a current limiter that monitors and controls the pass transistor's gate voltage, limiting the output current to 350mA (typ). The output can be shorted to ground for an indefinite period without damaging the part.

Thermal Overload Protection

When the junction temperature exceeds $T_J = +160^\circ\text{C}$, the thermal sensor signals the shutdown logic, turning off the pass transistor and allowing the IC to cool. The thermal sensor will turn the pass transistor on again after the IC's junction temperature cools by 20°C , resulting in a pulsed output during continuous thermal-overload conditions. Thermal overload protection is designed to protect the MAX6329/MAX6349 in the event of fault conditions. For continuous operation, do not exceed the absolute maximum junction temperature rating of $T_J = +150^\circ\text{C}$.

Operating Region and Power Dissipation

The MAX6329/MAX6349s' maximum power dissipation depends on the thermal resistance of the case and cir-

cuit board, the temperature difference between the die junction and the ambient air, and the rate of airflow. The power dissipation across the device is:

$$P = I_{OUT} (V_{IN} - V_{OUT})$$

The maximum power dissipation is:

$$P_{MAX} = (T_J - T_A) / (\theta_{JB} + \theta_{BA})$$

where $T_J - T_A$ is the temperature difference between the die junction and the surrounding air, θ_{JB} (or θ_{JC}) is the thermal resistance of the package, and θ_{BA} is the thermal resistance through the printed circuit board, copper traces, and other materials to the surrounding air.

The MAX6329/MAX6349s' ground pin (GND) performs the dual function of providing an electrical connection to the system ground and channeling heat away. Connect GND to the system ground using a large pad or ground plane.

Applications Information

Output Voltage Selection

The MAX6329/MAX6349 feature dual mode operation: they operate in either a preset voltage mode or an adjustable mode. In preset voltage mode, internal feedback resistors set the MAX6329/MAX6349 to +3.3V, +2.5V, or +1.8V (see *Selector Guide*). Select this mode by connecting SET to ground. In adjustable mode, select an output between 1.23V to 5.0V using two external resistors connected as a voltage divider to SET (Figure 1). The output voltage is set by the following equation:

$$V_{OUT} = V_{SET} (1 + R1/R2)$$

where $V_{SET} = 1.23\text{V}$. To simplify resistor selection:

$$R1 = R2 (V_{OUT}/V_{SET} - 1)$$

Choose $R2 \geq 100\text{k}\Omega$ to optimize power consumption, accuracy, and high-frequency power-supply rejection. Since the V_{SET} tolerance is typically less than $\pm 30\text{mV}$, the output can be set using fixed resistors instead of variable resistors. In preset voltage mode, impedance between SET and ground should be less than 50k Ω .

150mA, SOT23, Low Dropout Linear Regulators with Internal Microprocessor Reset Circuit

Capacitor Selection and Regulator Stability

For stable operation over the full temperature range and with load currents up to 150mA, use a 1 μ F (min) output capacitor. To reduce noise and improve load transient response, stability, and power-supply rejection, use large output capacitor values such as 10 μ F.

Note that some ceramic dielectrics exhibit large capacitance and ESR variation with temperature. With dielectrics such as Z5U and Y5V, it may be necessary to use 2.2 μ F or more to ensure stability at temperatures below -10°C. With X7R or X5R dielectrics, 1 μ F should be sufficient at all operating temperatures. A graph of the Region of Stable C_{OUT} ESR vs. Load Current is shown in the *Typical Operating Characteristics*.

To improve power-supply rejection and transient response use a 1 μ F capacitor between IN and GND.

Input-Output (Dropout) Voltage

A regulator's minimum input-output voltage differential (or dropout voltage) determines the lowest useable supply voltage. In battery powered systems, this will determine the useful end-of-life battery voltage. Since the MAX6329/MAX6349 use a P-channel MOSFET pass transistor, their dropout voltage is a function of R_{DS(ON)} multiplied by the load current (see *Electrical Characteristics*).

Negative Going OUT Transients

These supervisors are relatively immune to short-duration, negative going OUT transients. The *Typical*

Operating Characteristics section shows a graph of the Maximum Transient Duration vs. Reset Threshold Overdrive for which reset is not asserted. The graph was produced using negative going OUT transients starting at OUT and ending below the reset threshold by the magnitude indicated (Reset Threshold Overdrive). The graph shows the maximum pulse width that a negative going OUT transient can typically have without triggering a reset pulse. As the amplitude of the transient increases (i.e., goes further below the reset threshold), the maximum allowable pulse width decreases. Typically, an OUT transient that goes only 10mV below the reset threshold and lasts for 75 μ s will not trigger a reset pulse.

Chip Information

TRANSISTOR COUNT: 800

PROCESS: BiCMOS

Typical Operating Circuit

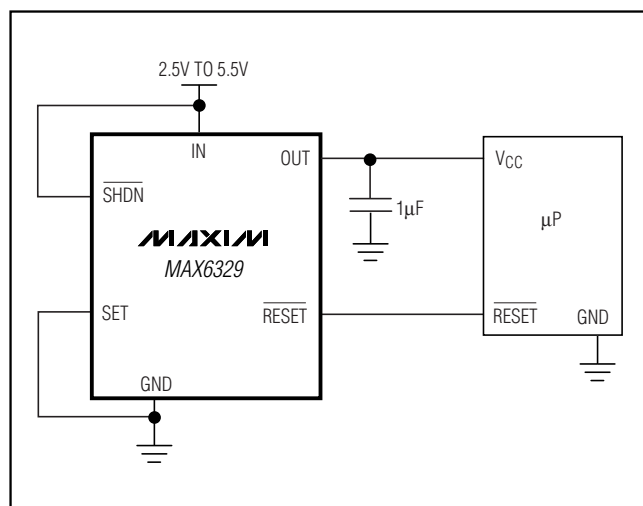

150mA, SOT23, Low Dropout Linear Regulators with Internal Microprocessor Reset Circuit

Selector Guide

PACKAGE INFORMATION	$\overline{\text{SHDN}}$	$\overline{\text{MR}}$	REGULATOR OUTPUT VOLTAGE			V _{OUT} RESET TOLERANCE		RESET OUTPUT			TOP MARK
			3.3V	2.5V	1.8V	-5% V _{TH} T/Z/W	-10% V _{TH} S/Y/V	OPEN-DRAIN (P)	$\overline{\text{RESET}}$ PUSH-PULL (L)	RESET PUSH-PULL (H)	
MAX6329TP	*		*			*		*			AAIP
MAX6329TL	*		*			*			*		AAIO
MAX6329TH	*		*			*				*	AAIN
MAX6329SP	*		*				*	*			AAIM
MAX6329SL	*		*				*		*		AAIL
MAX6329SH	*		*				*			*	AAIK
MAX6329ZP	*			*		*		*			AAJB
MAX6329ZL	*			*		*			*		AAJA
MAX6329ZH	*			*		*				*	AAIZ
MAX6329YP	*			*			*	*			AAIY
MAX6329YL	*			*			*		*		AAIX
MAX6329YH	*			*			*			*	AAIW
MAX6329WP	*				*	*		*			AAIV
MAX6329WL	*				*	*			*		AAIU
MAX6329WH	*				*	*				*	AAIT
MAX6329VP	*				*		*	*			AAIS
MAX6329VL	*				*		*		*		AAIR
MAX6329VH	*				*		*			*	AAIQ
MAX6349TP		*	*			*		*			AAJH
MAX6349TL		*	*			*			*		AAJQ
MAX6349TH		*	*			*				*	AAJF
MAX6349SP		*	*				*	*			AAJE
MAX6349SL		*	*				*		*		AAJD
MAX6349SH		*	*				*			*	AAJC
MAX6349ZP		*		*		*		*			AAJT
MAX6349ZL		*		*		*			*		AAJS
MAX6349ZH		*		*		*				*	AAJR
MAX6349YP		*		*			*	*			AAJG
MAX6349YL		*		*			*		*		AAJP
MAX6349YH		*		*			*			*	AAJO
MAX6349WP		*			*	*		*			AAJN
MAX6349WL		*			*	*			*		AAJM
MAX6349WH		*			*	*				*	AAJL
MAX6349VP		*			*		*	*			AAJK
MAX6349VL		*			*		*		*		AAJJ
MAX6349VH		*			*		*			*	AAJI

Bold items indicate standard versions. Samples are generally available on standard versions only. Contact factory for availability of nonstandard versions.

150mA, SOT23, Low Dropout Linear Regulators with Internal Microprocessor Reset Circuit

Package Information

(The package drawing(s) in this data sheet may not reflect the most current specifications. For the latest package outline information go to www.maxim-ic.com/packages.)

MAX6329/MAX6349

SYMBOL	MIN	MAX
A	0.90	1.45
A1	0.00	0.15
A2	0.90	1.30
b	0.35	0.50
C	0.08	0.20
D	2.80	3.00
E	2.60	3.00
E1	1.50	1.75
L	0.35	0.60
L1	0.60 REF.	
e1	1.90 BSC.	
e	0.95 BSC.	
a	0°	10°

NOTES:

- ALL DIMENSIONS ARE IN MILLIMETERS.
- FOOT LENGTH MEASURED AT INTERCEPT POINT BETWEEN DATUM A & LEAD SURFACE.
- PACKAGE OUTLINE EXCLUSIVE OF MOLD FLASH & METAL BURR. MOLD FLASH, PROTRUSION OR METAL BURR SHOULD NOT EXCEED 0.25 MM.
- PACKAGE OUTLINE INCLUSIVE OF SOLDER PLATING.
- PIN 1 IS LOWER LEFT PIN WHEN READING TOP MARK FROM LEFT TO RIGHT. (SEE EXAMPLE TOP MARK)
- PIN 1 I.D. DOT IS 0.3 MM Ø MIN. LOCATED ABOVE PIN 1.
- MEETS JEDEC MO178, VARIATION AB.
- SOLDER THICKNESS MEASURED AT FLAT SECTION OF LEAD BETWEEN 0.08mm AND 0.15mm FROM LEADTIP.
- LEAD TO BE COPLANAR WITHIN 0.1 MM.

DALLAS SEMICONDUCTOR **MAXIM**

PROPRIETARY INFORMATION

TITLE: PACKAGE OUTLINE, SOT-23, 6L

APPROVAL	DOCUMENT CONTROL NO. 21-0058	REV. F	1/1
----------	---------------------------------	-----------	-----

Maxim cannot assume responsibility for use of any circuitry other than circuitry entirely embodied in a Maxim product. No circuit patent licenses are implied. Maxim reserves the right to change the circuitry and specifications without notice at any time.

Maxim Integrated Products, 120 San Gabriel Drive, Sunnyvale, CA 94086 408-737-7600 11

OUR CERTIFICATE

DiGi provide top-quality products and perfect service for customer worldwide through standardization, technological innovation and continuous improvement. DiGi through third-party certification, we strictly control the quality of products and services. Welcome your RFQ to

Email: Info@DiGi-Electronics.com



Tel: +00 852-30501935

RFQ Email: Info@DiGi-Electronics.com

DiGi is a global authorized distributor of electronic components.