

# MAX6978APE+ Datasheet

[www.digi-electronics.com](http://www.digi-electronics.com)

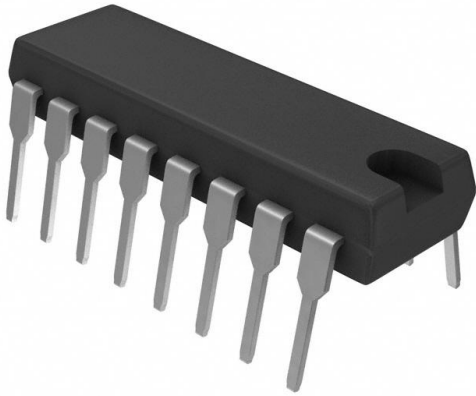

<https://www.DiGi-Electronics.com>

DiGi Electronics Part Number	MAX6978APE+-DG
Manufacturer	<a href="#">Analog Devices Inc./Maxim Integrated</a>
Manufacturer Product Number	MAX6978APE+
Description	IC LED DRIVER LINEAR 55MA 16DIP
Detailed Description	LED Driver IC 8 Output Linear Shift Register Dimming 55mA 16-PDIP



Tel: +00 852-30501935

RFQ Email: [Info@DiGi-Electronics.com](mailto:Info@DiGi-Electronics.com)

DiGi is a global authorized distributor of electronic components.

## Purchase and inquiry

Manufacturer Product Number:

MAX6978APE+

Series:

-

Type:

Linear

Internal Switch(s):

Yes

Voltage - Supply (Min):

3V

Voltage - Output:

5.5V

Frequency:

-

Applications:

Signage

Mounting Type:

Through Hole

Supplier Device Package:

16-PDIP

Manufacturer:

Analog Devices Inc./Maxim Integrated

Product Status:

Obsolete

Topology:

Shift Register

Number of Outputs:

8

Voltage - Supply (Max):

5.5V

Current - Output / Channel:

55mA

Dimming:

-

Operating Temperature:

-40°C ~ 125°C (TA)

Package / Case:

16-DIP (0.300", 7.62mm)

Base Product Number:

MAX6978

## Environmental & Export classification

RoHS Status:

ROHS3 Compliant

REACH Status:

REACH Unaffected

HTSUS:

8542.39.0001

Moisture Sensitivity Level (MSL):

1 (Unlimited)

ECCN:

EAR99





# 8-Port, 5.5V Constant-Current LED Driver with LED Fault Detection and Watchdog

**MAX6978**

## General Description

The MAX6978 serial-interfaced LED driver provides eight open-drain, constant-current sinking LED driver outputs rated at 5.5V. The MAX6978 operates from a 3V to 5.5V supply. The MAX6978 supply and the LEDs' supply can power up in any order. The constant-current outputs are programmed together to up to 55mA using a single external resistor. The MAX6978 operates with a 25Mb, industry-standard, 4-wire serial interface.

The MAX6978 includes circuitry that automatically detects open-circuit LEDs. Fault status is loaded into the serial-interface shift register when LE goes high and is automatically shifted out on DOUT when the next data transmission is shifted in.

The MAX6978 includes a fail-safe feature for safety-related applications, which blanks the display if the serial interface fails. If the serial interface becomes inactive for more than 1s, all driver output latches are automatically cleared. This turns off all LEDs connected to the outputs. The shift register data is not disturbed. The outputs remain off until the driver output latches are updated with data turning them on, so recovery is automatic if the transmission failure is temporary. The watchdog function requires no software change to the application driving the MAX6978.

The MAX6978 uses the industry-standard shift-register-plus-latch-type serial interface. The driver accepts data shifted into an 8-bit shift register using data input DIN and clock input CLK. Input data appears at the output DOUT eight clock cycles later to allow cascading of multiple MAX6978s. The latch-enable input LE loads the 8 bits of shift-register data into an 8-bit output latch to set which LEDs are on and which are off. The output-enable input  $\overline{OE}$  gates all eight outputs on and off, and is fast enough to be used as a PWM input for LED intensity control.

The MAX6978 is one of a family of 12 shift-register-plus-latch-type LED drivers. The family includes 8-port and 16-port types, with 5.5V- or 36V-rated LED outputs, with and without open-circuit LED detection and watchdog. All versions operate from a 3V to 5.5V supply, and are specified over the -40°C to +125°C temperature range.

## Applications

- Variable Message Signs
- Marquee Displays
- Point-of-Order Signs
- Traffic Signs
- Gaming Features
- Architectural Lighting

## Features

- ◆ 25Mb Industry-Standard 4-Wire Serial Interface at 5V
- ◆ 3V to 5.5V Logic Supply
- ◆ 8 Constant-Current LED Outputs Rated at 5.5V
- ◆ Up to 55mA Continuous Current per Output
- ◆ Output Current Programmed by Single Resistor
- ◆ 3% Current Matching Between Outputs
- ◆ 6% Current Matching Between ICs
- ◆ Watchdog Clears Display if Interface Fails
- ◆ Reports Open-Circuit LED Faults
- ◆ -40°C to +125°C Temperature Range

## Ordering Information

PART	TEMP RANGE	PIN-PACKAGE
MAX6978AUE	-40°C to +125°C	16 TSSOP-EP*
MAX6978APE	-40°C to +125°C	16 PDIP
MAX6978AAE	-40°C to +125°C	16 SSOP

\*EP = Exposed pad.

Typical Application Circuit and Selector Guide appear at end of data sheet.

## Pin Configuration

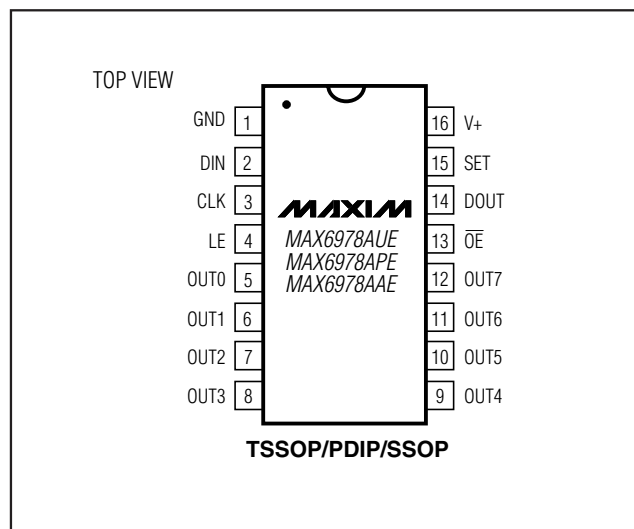

# 8-Port, 5.5V Constant-Current LED Driver with LED Fault Detection and Watchdog

MAX6978

## ABSOLUTE MAXIMUM RATINGS

Voltage (with respect to GND)

V+	.....-0.3V to +6V
OUT_	.....-0.3V to +6V
DIN, CLK, LE, $\overline{OE}$ , SET	.....-0.3V to (V+ + 0.3V)
DOUT Current	..... $\pm 10$ mA
OUT_ Sink Current	.....60mA
Total GND Current	.....480mA

Continuous Power Dissipation ( $T_A = +70^\circ\text{C}$ )

16-Pin SSOP (derate 7.1mW/ $^\circ\text{C}$ above $+70^\circ\text{C}$ )	.....571mW
16-Pin PDIP (derate 10.5mW/ $^\circ\text{C}$ above $+70^\circ\text{C}$ )	.....842mW
16-Pin TSSOP (derate 21.3mW/ $^\circ\text{C}$ over $T_A = +70^\circ\text{C}$ )	.....1702mW
Operating Temperature Range	..... $-40^\circ\text{C}$ to $+125^\circ\text{C}$
Junction Temperature	..... $+150^\circ\text{C}$
Storage Temperature Range	..... $-65^\circ\text{C}$ to $+150^\circ\text{C}$
Lead Temperature (soldering, 10s)	..... $+300^\circ\text{C}$

Stresses beyond those listed under "Absolute Maximum Ratings" may cause permanent damage to the device. These are stress ratings only, and functional operation of the device at these or any other conditions beyond those indicated in the operational sections of the specifications is not implied. Exposure to absolute maximum rating conditions for extended periods may affect device reliability.

## ELECTRICAL CHARACTERISTICS

(Typical Operating Circuit,  $V_+ = 3\text{V}$  to  $5.5\text{V}$ ,  $T_A = T_{\text{MIN}}$  to  $T_{\text{MAX}}$ , unless otherwise noted. Typical values are at  $V_+ = 5\text{V}$ ,  $T_A = +25^\circ\text{C}$ .) (Note 1)

PARAMETER	SYMBOL	CONDITIONS	MIN	TYP	MAX	UNITS
Operating Supply Voltage	$V_+$		3.0		5.5	V
Output Voltage	$V_{\text{OUT}}$				5.5	V
Standby Current (Interface Idle, All Output Ports High Impedance, $R_{\text{SET}} = 360\Omega$ )	$I_+$	All logic inputs at $V_+$ or GND, DOUT unloaded		4.5	5.6	mA
Standby Current (Interface Running, All Output Ports High Impedance, $R_{\text{SET}} = 360\Omega$ )	$I_+$	$f_{\text{CLK}} = 5\text{MHz}$ , $\overline{OE} = V_+$ , DIN and LE = $V_+$ or GND, DOUT unloaded		4.7	6	mA
Supply Current (Interface Idle, All Output Ports Active Low, $R_{\text{SET}} = 360\Omega$ )	$I_+$	All logic inputs at $V_+$ or GND, DOUT unloaded		10	25	mA
Input High Voltage DIN, CLK, LE, $\overline{OE}$	$V_{\text{IH}}$		0.7 $V_+$			V
Input Low Voltage DIN, CLK, LE, $\overline{OE}$	$V_{\text{IL}}$				0.3 $V_+$	V
Hysteresis Voltage DIN, CLK, LE, $\overline{OE}$	$\Delta V_{\text{I}}$			0.8		V
Input Leakage Current DIN, CLK, LE, $\overline{OE}$	$I_{\text{IH}}$ , $I_{\text{IL}}$		-1		+1	$\mu\text{A}$
Output-High Voltage DOUT	$V_{\text{OH}}$	$I_{\text{SOURCE}} = 4\text{mA}$	$V_+$ -0.5V			V
Output Low Voltage	$V_{\text{OL}}$	$I_{\text{SINK}} = 4\text{mA}$			0.5	V
Output Current OUT_	$I_{\text{OUT}}$	$V_+ = 3\text{V}$ to $5.5\text{V}$ , $V_{\text{OUT}} = 0.8\text{V}$ to $2.5\text{V}$ , $R_{\text{SET}} = 360\Omega$	42	50	56	mA
Output Leakage Current OUT_	$I_{\text{LEAK}}$	$\overline{OE} = V_+$ , $V_{\text{OUT}} = V_+$			1	$\mu\text{A}$
Watchdog Timeout	$t_{\text{WD}}$			1		s

# 8-Port, 5.5V Constant-Current LED Driver with LED Fault Detection and Watchdog

## 5V TIMING CHARACTERISTICS

(Typical Operating Circuit,  $V_+ = 4.5V$  to  $5.5V$ ,  $T_A = T_{MIN}$  to  $T_{MAX}$ , unless otherwise noted.) (Note 1)

PARAMETER	SYMBOL	CONDITIONS	MIN	TYP	MAX	UNITS
CLK Clock Period	$t_{CP}$		40			ns
CLK Pulse-Width High	$t_{CH}$		19			ns
CLK Pulse-Width Low	$t_{CL}$		19			ns
DIN Setup Time	$t_{DS}$		4			ns
DIN Hold Time	$t_{DH}$		8			ns
DOUT Propagation Delay	$t_{DO}$		12		32	ns
DOUT Rise and Fall Time	$t_{DR}, t_{DF}$	$C_{DOUT} = 10pF, 20\%$ to $80\%$			10	ns
LE Pulse-Width High	$t_{LW}$		20			ns
LE Pulse Width (Fault-Detection Data Valid)	$t_{LF}$		20			ns
LE Setup Time	$t_{LS}$		10			ns
LE Rising to OUT_ Rising Delay	$t_{LRR}$	(Note 2)			100	ns
LE Rising to OUT_ Falling Delay	$t_{LRF}$	(Note 2)			280	ns
CLK Rising to OUT_ Rising Delay	$t_{CRR}$	(Note 2)			100	ns
CLK Rising to OUT_ Falling Delay	$t_{CRF}$	(Note 2)			310	ns
$\overline{OE}$ Rising to OUT_ Rising Delay	$t_{\overline{OE}H}$				100	ns
$\overline{OE}$ Falling to OUT_ Falling Delay	$t_{\overline{OE}L}$				300	ns
LED Output OUT_ Turn-On Fall Time	$t_f$	80% to 20%			200	ns
LED Output OUT_ Turn-Off Rise Time	$t_r$	20% to 80%			120	ns

MAX6978

# 8-Port, 5.5V Constant-Current LED Driver with LED Fault Detection and Watchdog

## 3.3V TIMING CHARACTERISTICS

(Typical Operating Circuit,  $V_+ = 3V$  to  $5.5V$ ,  $T_A = T_{MIN}$  to  $T_{MAX}$ , unless otherwise noted.) (Note 1)

PARAMETER	SYMBOL	CONDITIONS	MIN	TYP	MAX	UNITS
CLK Clock Period	$t_{CP}$		52			ns
CLK Pulse-Width High	$t_{CH}$		24			ns
CLK Pulse-Width Low	$t_{CL}$		24			ns
DIN Setup Time	$t_{DS}$		4			ns
DIN Hold Time	$t_{DH}$		8			ns
DOUT Propagation Delay	$t_{DO}$		12		48	ns
DOUT Rise and Fall Time		$C_{DOUT} = 10pF$ , 20% to 80%			10	ns
LE Pulse-Width High	$t_{LW}$		20			ns
LE Pulse Width (Fault-Detection Data Valid)	$t_{LW}$		20			ns
LE Setup Time	$t_{LS}$		15			ns
LE Rising to OUT_ Rising Delay					100	ns
LE Rising to OUT_ Falling Delay					310	ns
CLK Rising to OUT_ Rising Delay					100	ns
CLK Rising to OUT_ Falling Delay					330	ns
$\overline{OE}$ Rising to OUT_ Rising Delay	$t_{\overline{OE}H}$				100	ns
$\overline{OE}$ Falling to OUT_ Falling Delay	$t_{\overline{OE}L}$				330	ns
LED Output OUT_ Turn-On Fall Time	$t_f$	80% to 20%			200	ns
LED Output OUT_ Turn-Off Rise Time	$t_r$	20% to 80%			120	ns

**Note 1:** All parameters tested at  $T_A = +25^\circ C$ . Specifications over temperature are guaranteed by design.

**Note 2:** See Figure 3.

## Typical Operating Characteristics

( $T_A = +25^\circ C$ , unless otherwise noted.)

**SUPPLY CURRENT vs. SUPPLY VOLTAGE**  
(INTERFACE IDLE, ALL OUTPUTS OFF,  $R_{SET} = 720\Omega$ )

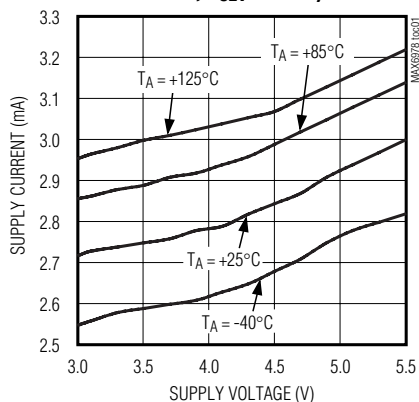

**SUPPLY CURRENT vs. SUPPLY VOLTAGE**  
(INTERFACE IDLE, ALL OUTPUTS OFF,  $R_{SET} = 360\Omega$ )

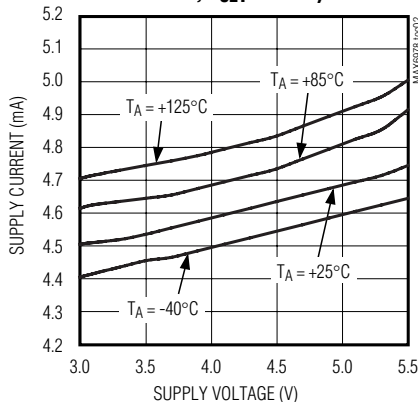

**SUPPLY CURRENT vs. SUPPLY VOLTAGE**  
(INTERFACE IDLE, ALL OUTPUTS ON,  $R_{SET} = 720\Omega$ )

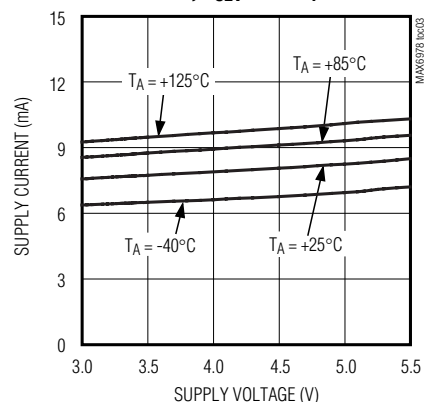

# 8-Port, 5.5V Constant-Current LED Driver with LED Fault Detection and Watchdog

MAX6978

## Typical Operating Characteristics (continued)

( $T_A = +25^\circ\text{C}$ , unless otherwise noted.)

**SUPPLY CURRENT vs. SUPPLY VOLTAGE (INTERFACE IDLE, ALL OUTPUTS ON,  $R_{SET} = 360\Omega$ )**

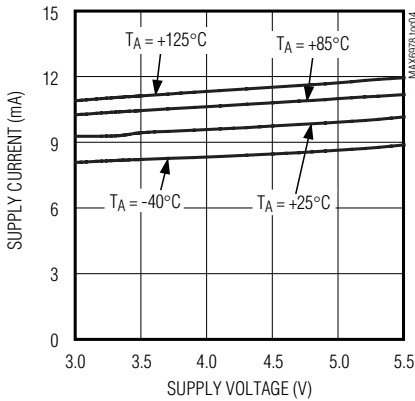

**PORT OUTPUT CURRENT vs. PORT OUTPUT VOLTAGE ( $R_{SET} = 720\Omega$ ,  $V_+ = 3.3\text{V}$ )**

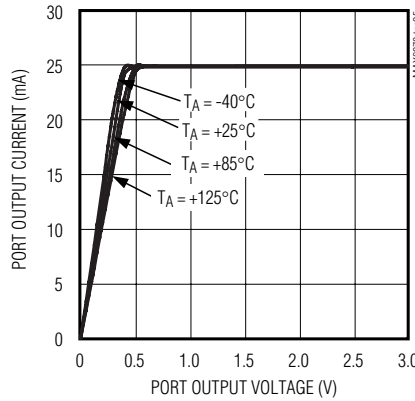

**PORT OUTPUT CURRENT vs. PORT OUTPUT VOLTAGE ( $R_{SET} = 360\Omega$ ,  $V_+ = 3.3\text{V}$ )**

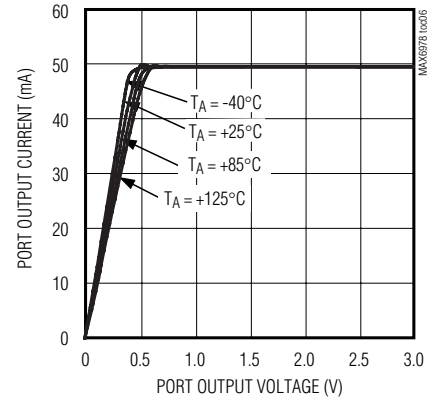

**PORT OUTPUT CURRENT vs. PORT OUTPUT VOLTAGE ( $R_{SET} = 720\Omega$ ,  $V_+ = 5.0\text{V}$ )**

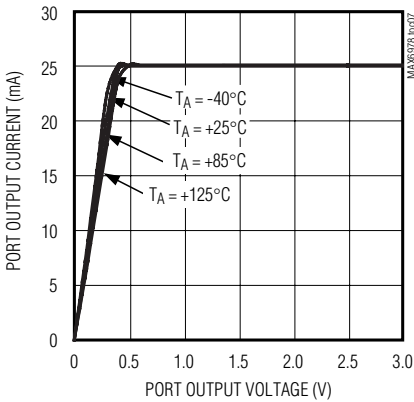

**PORT OUTPUT CURRENT vs. PORT OUTPUT VOLTAGE ( $R_{SET} = 360\Omega$ ,  $V_+ = 5.0\text{V}$ )**

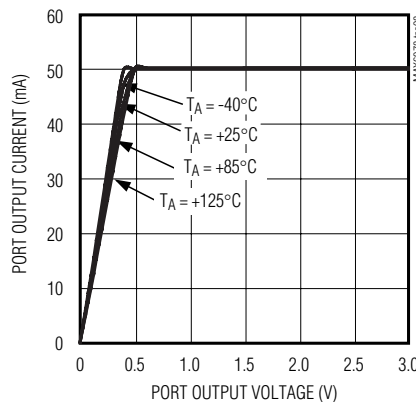

**PORT OUTPUT CURRENT vs. SUPPLY VOLTAGE ( $R_{SET} = 720\Omega$ ,  $V_{OUT} = 2\text{V}$ )**

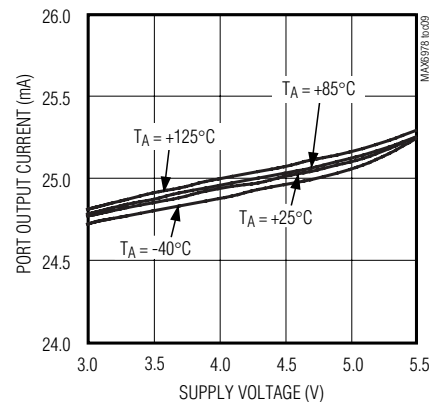

**PORT OUTPUT CURRENT vs. SUPPLY VOLTAGE ( $R_{SET} = 360\Omega$ ,  $V_{OUT} = 2\text{V}$ )**

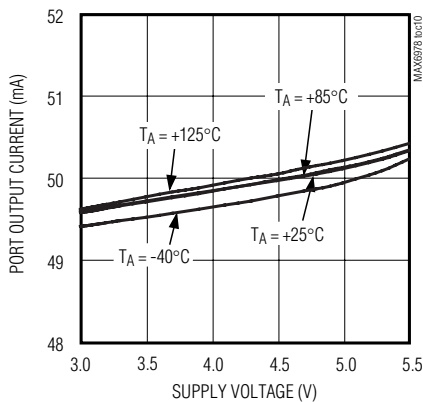

**PORT OUTPUT CURRENT vs.  $R_{SET}$  RESISTANCE ( $V_+ = 5.0\text{V}$ )**

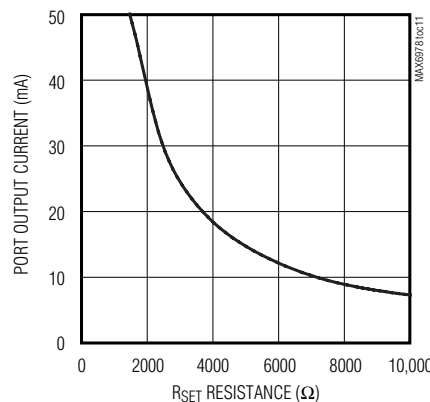







## 8-Port, 5.5V Constant-Current LED Driver with LED Fault Detection and Watchdog

$\overline{OE}$  is independent of the operation of the serial interface. Data can be shifted into the serial-interface shift register and latched regardless of the state of  $\overline{OE}$ .

DOUT is the serial-data output, which shifts data out from the MAX6978's 8-bit shift register on the rising edge of CLK. Data at DIN is propagated through the shift register and appears at DOUT eight clock cycles later.

### Watchdog

The MAX6978 includes a watchdog circuit that monitors the CLK, DIN, and LE inputs. If there is no transition on any one of these inputs for nominally 1s, then the output latches are cleared and outputs OUT0–OUT7 go high impedance like the initial power-up condition. This turns off all LEDs connected to the outputs. The shift-register data does not change, just the output-latch data.

The watchdog is intended to be used as a fail-safe feature for applications, which prefer a blank display to an incorrect display if the serial interface fails. When the watchdog triggers, the outputs remain off until the driver output latches are updated with data turning them on. Recovery is therefore automatic if the transmission failure is temporary, because the MAX6978 does not lock up in the watchdog timeout state. The MAX6978 operates correctly when the serial interface is next activated, and the watchdog circuit is reset and starts monitoring the serial interface again. The watchdog

function requires no software change to the application driving the MAX6978.

### LED Fault Detection

The MAX6978 includes circuitry that detects open-circuit LEDs automatically. An open-circuit fault occurs when an output is programmed to sink current but less than about 50% of the programmed current flows. Open circuits are checked just after the rising edge of LE, when new LED data is loaded into the output latches from the shift register(s). If one or more output port is detected with an open-circuit fault, then the 2 bits, D6 and D5, in the serial-interface shift register are both set high. If no open-circuit faults are detected, then D6 and D5 are both cleared low. The data in other 6-bit positions in the serial-interface shift register is not altered.

Fault status is automatically shifted out on DOUT when the next data transmission is shifted in. LE is normally taken high after all 8 bits of new LED data have been clocked into the shift register, and so at that time, DOUT is outputting data bit D7. On the next two rising edges of CLK, the 2 fault status bits, D6 and D5, are clocked out in that order, followed by the remaining 5 unchanged data bits D4 to D0.

A typical fault-detecting application tests all the shifted out data. Bits D0–D4 and D7 are checked against the originally transmitted data to check data link integrity. Bits D5 and D6 are checked first to see that they con-

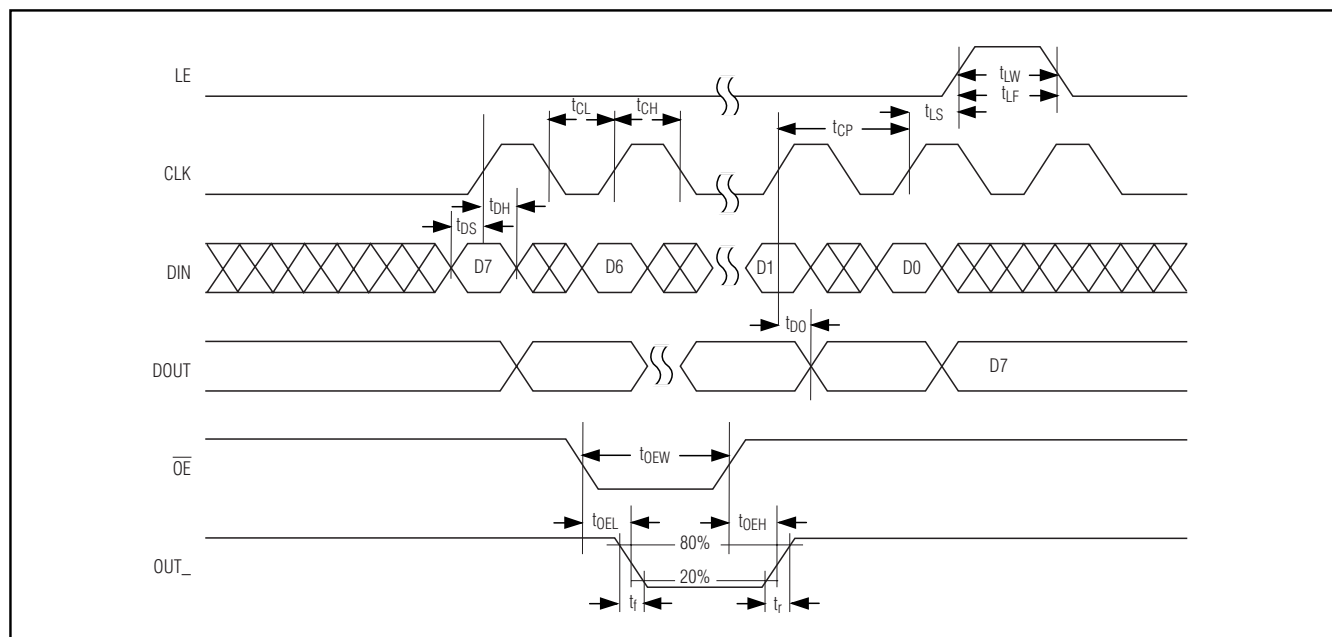

Figure 2. 4-Wire Serial-Interface Timing Diagram

## 8-Port, 5.5V Constant-Current LED Driver with LED Fault Detection and Watchdog

MAX6978

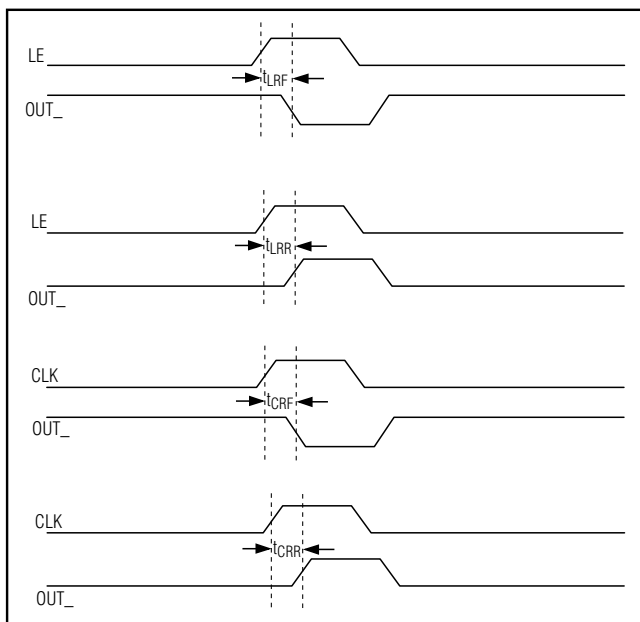

Figure 3. LE and CLK to OUT\_ Timing

tain the same data (validating the status), and second whether faults are reported by the actual logic level.

The fault status bit identifies which driver chip has at least one open-circuit LED. It is possible to determine how many LEDs driven by a chip are at fault by running eight test patterns, each of which lights a different single LED. The fault status bit then effectively identifies only one output at a time.

### Applications Information

#### Selecting External Component RSET to Set LED Output Current

The MAX6978 uses an external resistor RSET to set the LED current for outputs OUT0–OUT7. The minimum allowed value of RSET is 307.6Ω, which sets the output currents to 55mA. The maximum allowed value of RSET is 1.5kΩ. The reference value, 360Ω, sets the output currents to 50mA. To set a different output current, use the formula:

$$R_{SET} = 18,000 / I_{OUT}$$

where I<sub>OUT</sub> is the desired output current in mA.

#### Computing Power Dissipation

The upper limit for power dissipation (P<sub>D</sub>) for the MAX6978 is determined from the following equation:

$$P_D = (V_+ \times I_+) + (V_{OUT} \times DUTY \times I_{OUT} \times N)$$

where:

$$V_+ = \text{supply voltage}$$

I<sub>+</sub> = operating supply current when sinking I<sub>OUT</sub> LED drive current into N outputs

DUTY = PWM duty cycle applied to  $\overline{OE}$

N = number of MAX6978 outputs driving LEDs at the same time (maximum is 8)

V<sub>OUT</sub> = MAX6978 port output voltage when driving load LED(s)

I<sub>OUT</sub> = LED drive current programmed by RSET

P<sub>D</sub> = power dissipation, in mW if currents are in mA

Dissipation example:

I<sub>OUT</sub> = 47mA, N = 8, DUTY = 1, V<sub>OUT</sub> = 2V, V<sub>+</sub> = 5.25V

$$P_D = (5.25V \times 25mA) + (2V \times 1 \times 47mA \times 8) = 0.883W$$

Thus, for a 16-pin TSSOP package (T<sub>JA</sub> = 1 / 0.0213 = +46.95°C/W from the *Absolute Maximum Ratings*), the maximum allowed ambient temperature T<sub>A</sub> is given by:

$$T_{J(MAX)} = T_A + (P_D \times T_{JA}) = +150^\circ C = T_A + (0.883 \times 46.95^\circ C/W)$$

so T<sub>A</sub> = +108.5°C.

#### Overtemperature Cutoff

The MAX6978 contains an internal temperature sensor that turns off all outputs when the die temperature exceeds approximately +165°C. The outputs are enabled again when the die temperature drops below approximately +140°C. Register contents are not affected, so when a driver is overdissipating the external symptom will be the load LEDs cycling between on and off as the driver repeatedly overheats and cools, alternately turning the LEDs off and then back on again.

#### Power-Supply Considerations

The MAX6978 operates with a chip supply V<sub>+</sub>, and one or more LED supplies. Bypass each supply to GND with a 0.1μF capacitor as close to the MAX6978 as possible. This is normally adequate for static LED driving. For multiplex or PWM applications, it is necessary to add an additional bulk electrolytic capacitor of 4.7μF or more to each supply for every 4 to 16 MAX6978s. The necessary capacitance depends on the LED load current, PWM switching frequency, and serial interface speed. Inadequate V<sub>+</sub> decoupling can cause timing problems, and very noisy LED supplies can affect LED current regulation.

For the TSSOP version, connect the underside exposed pad to GND.

#### Chip Information

TRANSISTOR COUNT: 2382

PROCESS: BiCMOS

# 8-Port, 5.5V Constant-Current LED Driver with LED Fault Detection and Watchdog

## Selector Guide

PART	NO. OF OUTPUTS	MAX OUTPUT VOLTAGE (V)	MAX OUTPUT CURRENT	LED FAULT DETECTION	WATCHDOG
MAX6968	8	5.5	55mA	—	—
MAX6977				Yes	—
MAX6978				Yes	Yes
MAX6970	8	36		—	—
MAX6981				Yes	—
MAX6980				Yes	Yes
MAX6969	16	5.5		—	—
MAX6984				Yes	—
MAX6979				Yes	Yes
MAX6971	16	36		—	—
MAX6982				Yes	—
MAX6983				Yes	Yes

## Typical Application Circuit

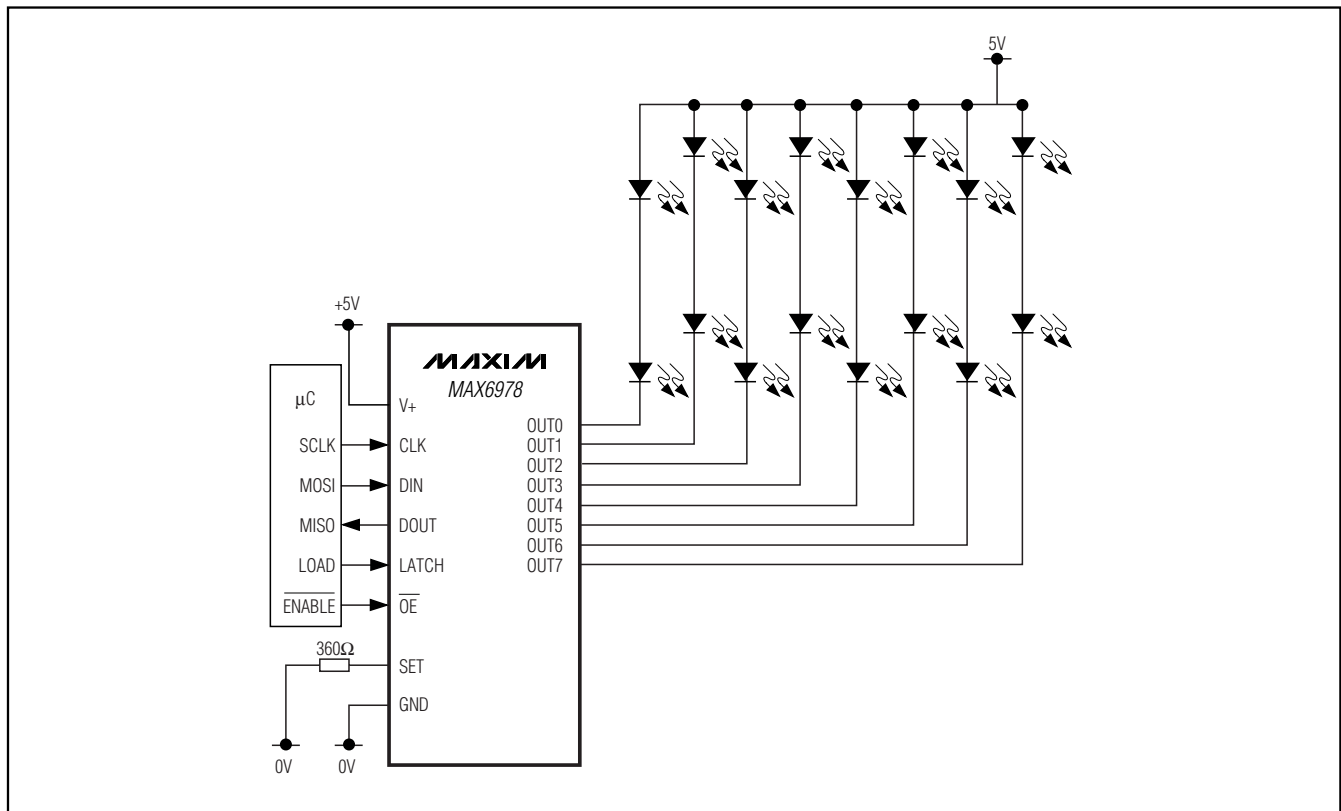

# 8-Port, 5.5V Constant-Current LED Driver with LED Fault Detection and Watchdog

## Package Information

(The package drawing(s) in this data sheet may not reflect the most current specifications. For the latest package outline information, go to [www.maxim-ic.com/packages](http://www.maxim-ic.com/packages).)

MAX6978

SYMBOL	COMMON DIMENSIONS			
	MILLIMETERS		INCHES	
A	MIN.	MAX.	MIN.	MAX.
A	--	1.10	--	0.043
A1	0.00	0.15	0.000	0.006
A2	0.85	0.95	0.033	0.037
b	0.19	0.30	0.007	0.012
b1	0.19	0.25	0.007	0.010
c	0.090	0.20	0.004	0.008
c1	0.090	0.135	0.004	0.0053
D	SEE VARIATIONS	SEE VARIATIONS		
E	4.30	4.50	0.169	0.177
e	0.65	BSC	0.026	BSC
H	6.25	6.50	0.246	0.256
L	0.50	0.70	0.020	0.028
N	SEE VARIATIONS	SEE VARIATIONS		
Y	2.85	3.15	0.112	0.124
α	0°	8°	0°	8°

JEDEC			VARIATIONS			
			MILLIMETERS		INCHES	
MD-153	N		MIN.	MAX.	MIN.	MAX.
ABT-1	14	D	4.90	5.10	0.193	0.201
		X	2.95	3.25	0.116	0.128
ABT	16	D	4.90	5.10	0.193	0.201
		X	2.85	3.15	0.112	0.124
ACT	20	D	6.40	6.60	0.252	0.260
		X	4.00	4.34	0.157	0.171
AET	28	D	9.60	9.80	0.378	0.386
		X	5.35	5.65	0.211	0.222

**NOTES:**

- DIMENSIONS D AND E DO NOT INCLUDE FLASH.
- MOLD FLASH OR PROTRUSIONS NOT TO EXCEED 0.15mm PER SIDE.
- CONTROLLING DIMENSION: MILLIMETERS.
- MEETS JEDEC OUTLINE MD-153, SEE JEDEC VARIATIONS TABLE.
- 'N' REFERS TO NUMBER OF LEADS.
- EXPOSED PAD FLUSH WITH BOTTOM OF PACKAGE WITHIN .002".
- THE LEAD TIPS MUST LIE WITHIN A SPECIFIED ZONE. THIS TOLERANCE ZONE IS DEFINED BY TWO PARALLEL PLANES. ONE PLANE IS THE SEATING PLANE, DATUM [-C-]; THE OTHER PLANE IS AT THE SPECIFIED DISTANCE FROM [-C-] IN THE DIRECTION INDICATED.
- MARKING IS FOR PACKAGE ORIENTATION REFERENCE ONLY.
- NUMBER OF LEADS SHOWN ARE FOR REFERENCE ONLY.

-DRAWING NOT TO SCALE-

TITLE PACKAGE OUTLINE, TSSOP, 4.40 MM BODY, EXPOSED PAD			
APPROVAL	DOCUMENT CONTROL NO.	REV.	1/1
	21-0108	E	

TSSOP 4.4mm BODY LEFS



MAX6978

# 8-Port, 5.5V Constant-Current LED Driver with LED Fault Detection and Watchdog

## Package Information (continued)

(The package drawing(s) in this data sheet may not reflect the most current specifications. For the latest package outline information, go to [www.maxim-ic.com/packages](http://www.maxim-ic.com/packages).)

DIM	INCHES		MILLIMETERS	
	MIN	MAX	MIN	MAX
A	0.068	0.078	1.73	1.99
A1	0.002	0.008	0.05	0.21
B	0.010	0.015	0.25	0.38
C	0.004	0.008	0.09	0.20
D	SEE VARIATIONS			
E	0.205	0.212	5.20	5.38
e	0.0256 BSC		0.65 BSC	
H	0.301	0.311	7.65	7.90
L	0.025	0.037	0.63	0.95
$\alpha$	0	8	0	8

DIM	INCHES		MILLIMETERS		N
	MIN	MAX	MIN	MAX	
D	0.239	0.249	6.07	6.33	14L
D	0.239	0.249	6.07	6.33	16L
D	0.278	0.289	7.07	7.33	20L
D	0.317	0.328	8.07	8.33	24L
D	0.397	0.407	10.07	10.33	28L

NOTES:

1. D&E DO NOT INCLUDE MOLD FLASH.
2. MOLD FLASH OR PROTRUSIONS NOT TO EXCEED .15 MM (.006").
3. CONTROLLING DIMENSION: MILLIMETERS.
4. MEETS JEDEC MO150.
5. LEADS TO BE COPLANAR WITHIN 0.10 MM.

<small>PROPRIETARY INFORMATION</small>		
TITLE: PACKAGE OUTLINE, SSOP, 5.3 MM		
APPROVAL	DOCUMENT CONTROL NO. 21-0056	REV. C 1/1

SSOP-EFS

# 8-Port, 5.5V Constant-Current LED Driver with LED Fault Detection and Watchdog

## Package Information (continued)

(The package drawing(s) in this data sheet may not reflect the most current specifications. For the latest package outline information, go to [www.maxim-ic.com/packages](http://www.maxim-ic.com/packages).)

**MAX6978**

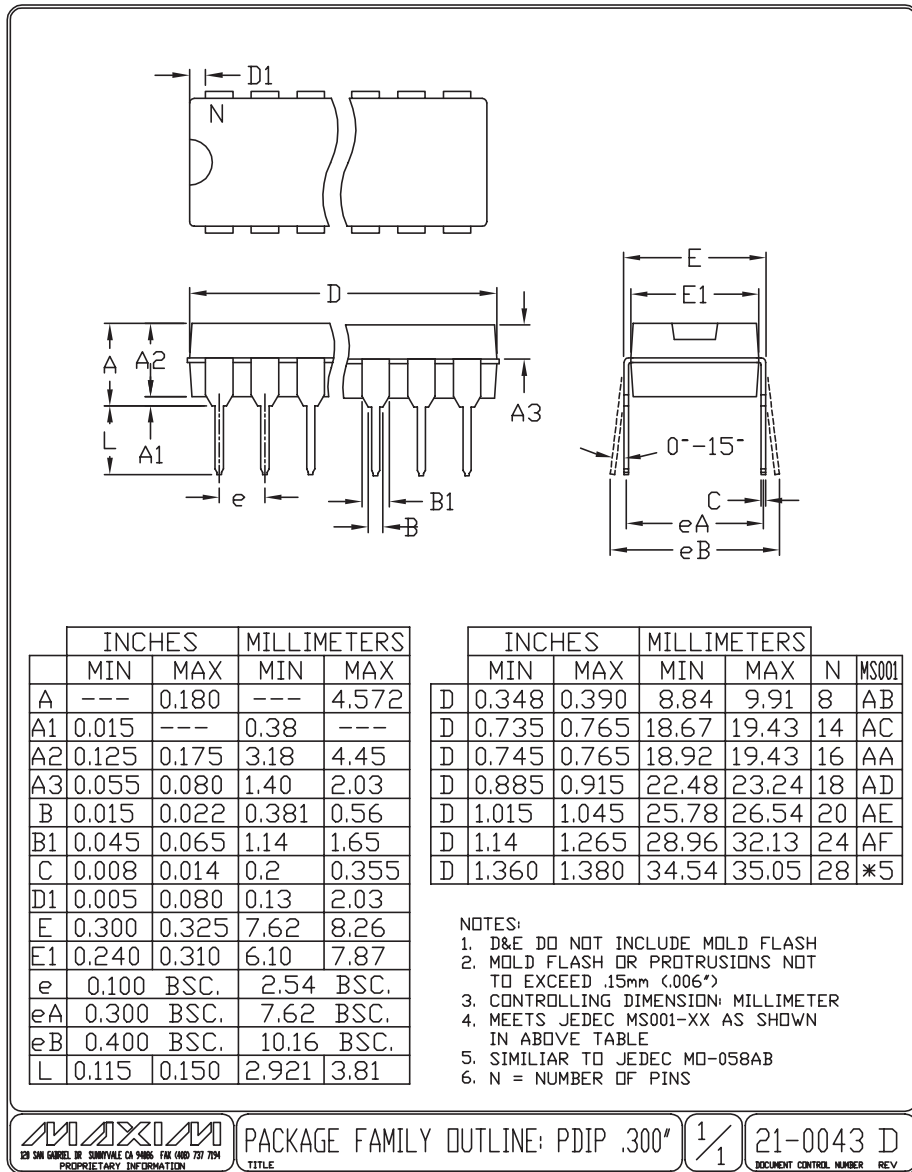

Maxim cannot assume responsibility for use of any circuitry other than circuitry entirely embodied in a Maxim product. No circuit patent licenses are implied. Maxim reserves the right to change the circuitry and specifications without notice at any time.

**Maxim Integrated Products, 120 San Gabriel Drive, Sunnyvale, CA 94086 408-737-7600** \_\_\_\_\_ 13

## OUR CERTIFICATE

DiGi provide top-quality products and perfect service for customer worldwide through standardization, technological innovation and continuous improvement. DiGi through third-party certification, we stricly control the quality of products and services. Welcome your RFQ to

Email: [Info@DiGi-Electronics.com](mailto:Info@DiGi-Electronics.com)



Tel: +00 852-30501935

RFQ Email: [Info@DiGi-Electronics.com](mailto:Info@DiGi-Electronics.com)

DiGi is a global authorized distributor of electronic components.