

MAX758AEWE+ Datasheet

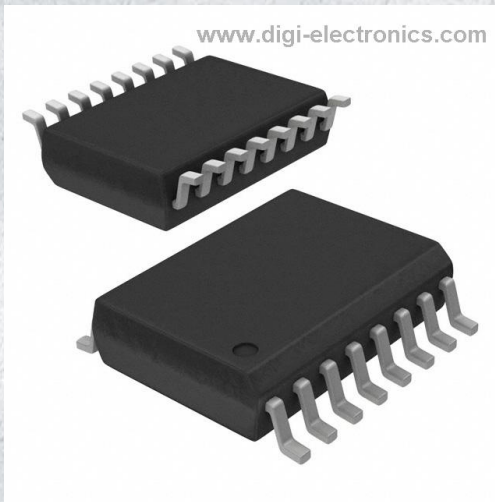

<https://www.DiGi-Electronics.com>

DiGi Electronics Part Number	MAX758AEWE+-DG
Manufacturer	Analog Devices Inc./Maxim Integrated
Manufacturer Product Number	MAX758AEWE+
Description	IC REG BUCK ADJ 750MA 16SOIC
Detailed Description	Buck Switching Regulator IC Positive Adjustable 1.2V 1 Output 750mA 16-SOIC (0.295", 7.50mm Width)



Tel: +00 852-30501935

RFQ Email: Info@DiGi-Electronics.com

DiGi is a global authorized distributor of electronic components.

Purchase and inquiry

Manufacturer Product Number:

MAX758AEWE+

Series:

-

Function:

Step-Down

Topology:

Buck

Number of Outputs:

1

Voltage - Input (Max):

16V

Voltage - Output (Max):

16V

Frequency - Switching:

160kHz

Operating Temperature:

-40°C ~ 85°C (TA)

Package / Case:

16-SOIC (0.295", 7.50mm Width)

Base Product Number:

MAX758

Manufacturer:

Analog Devices Inc./Maxim Integrated

Product Status:

Active

Output Configuration:

Positive

Output Type:

Adjustable

Voltage - Input (Min):

4V

Voltage - Output (Min/Fixed):

1.22V

Current - Output:

750mA

Synchronous Rectifier:

No

Mounting Type:

Surface Mount

Supplier Device Package:

16-SOIC

Environmental & Export classification

RoHS Status:

ROHS3 Compliant

REACH Status:

REACH Unaffected

HTSUS:

8542.39.0001

Moisture Sensitivity Level (MSL):

1 (Unlimited)

ECCN:

EAR99

19-0195; Rev 0; 10/93



Adjustable, Step-Down, Current-Mode PWM Regulators

MAX750A/MAX758A

General Description

The MAX750A/MAX758A are adjustable-output, CMOS, step-down, DC-DC switching regulators. The MAX758A accepts inputs from 4V to 16V and delivers 750mA, while the MAX750A accepts inputs from 4V to 11V and delivers 450mA. Typical efficiencies are 85% to 90%. Typical quiescent current is 1.7mA, or only 6µA in shutdown mode. The output does not exhibit any ripple at subharmonics of the switching frequency over its specified range.

Pulse-width-modulation (PWM) current-mode control provides precise output regulation and excellent transient responses. Output voltage accuracy is guaranteed to be ±4.5% plus feedback-resistor tolerance over line, load, and temperature variations. Fixed-frequency switching and absence of subharmonic ripple allows easy filtering of output ripple and noise, as well as the use of small external components. These regulators require only a single inductor value to work in most applications, so no inductor design is necessary.

Applications

- Cellular Phones & Radios
- Portable Communications Equipment
- Portable Instruments
- Computer Peripherals

Features

- ◆ Up to 750mA Load Currents
- ◆ 160kHz High-Frequency, Current-Mode PWM
- ◆ 85% to 96% Efficiencies
- ◆ 33µH or 100µH Pre-Selected Inductor Value, No Component Design Required
- ◆ 1.7mA Quiescent Supply Current
- ◆ 6µA Shutdown Supply Current
- ◆ Adjustable Output Voltage
- ◆ Overcurrent, Soft-Start, and Undervoltage Lockout Protection
- ◆ Cycle-by-Cycle Current Limiting
- ◆ 8-Pin DIP/SO Packages (MAX750A)

Ordering Information

PART	TEMP. RANGE	PIN-PACKAGE
MAX750ACPA	0°C to +70°C	8 Plastic DIP
MAX750ACSA	0°C to +70°C	8 SO
MAX750AC/D	0°C to +70°C	Dice*
MAX750AEPA	-40°C to +85°C	8 Plastic DIP
MAX750AESA	-40°C to +85°C	8 SO
MAX750AMJA	-55°C to +125°C	8 CERDIP**

Ordering Information continued on last page.

* Contact factory for dice specifications.

**Contact factory for availability and processing to MIL-STD-883.

Pin Configurations

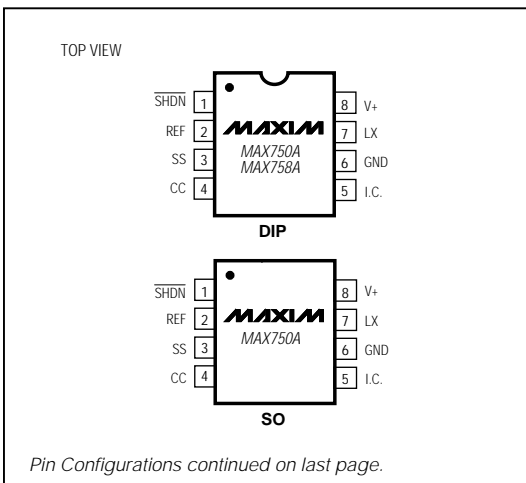

Typical Operating Circuit

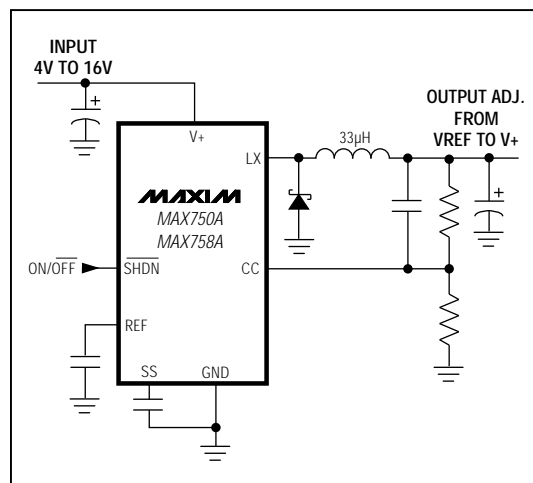

Adjustable, Step-Down, Current-Mode PWM Regulators

MAX750A/MAX758A

ABSOLUTE MAXIMUM RATINGS

Pin Voltages

V+ (MAX750A)	+12V, -0.3V
V+ (MAX758A)	+18V, -0.3V
LX (MAX750A)	(V+ - 12V) to (V+ + 0.3V)
LX (MAX758A)	(V+ - 21V) to (V+ + 0.3V)
SS, CC, SHDN	-0.3V to (V+ + 0.3V)
Peak Switch Current (ILX)	2A
Reference Current (IREF)	2.5mA
Power Dissipation (TA = +70°C)	
8-Pin Plastic DIP (derate 9.09mW/°C above +70°C)	727mW
8-Pin SO (derate 5.88mW/°C above +70°C)	471mW
16-Pin Wide SO (derate 9.52mW/°C above +70°C)	762mW
8-Pin CERDIP (derate 8.00mW/°C above +70°C)	640mW

Operating Temperature Ranges:

MAX75_AC_ _	0°C to +70°C
MAX75_AE_ _	-40°C to +85°C
MAX75_AMJA	-55°C to +125°C
Junction Temperatures:	
MAX75_AC_ _/AE_ _	+150°C
MAX75_AMJA	+175°C
Storage Temperature Range	-65°C to +160°C
Lead Temperature (soldering, 10sec)	+300°C

Stresses beyond those listed under "Absolute Maximum Ratings" may cause permanent damage to the device. These are stress ratings only, and functional operation of the device at these or any other conditions beyond those indicated in the operational sections of the specifications is not implied. Exposure to absolute maximum rating conditions for extended periods may affect device reliability.

ELECTRICAL CHARACTERISTICS

(Circuit of Figure 3, V+ = 9V for the MAX750A, V+ = 12V for the MAX758A, VOUT = 5V, R2 = 40.20kΩ, R3 = 13.0kΩ, ILOAD = 0mA, TA = TMIN to TMAX, unless otherwise noted.)

PARAMETER	CONDITIONS	MAX750A			MAX758A			UNITS
		MIN	TYP	MAX	MIN	TYP	MAX	
Output Voltage (Note 1)	V+ = 6.0V to 11.0V; 0mA < ILOAD < 450mA for MAX750AC, 0mA < ILOAD < 450mA for MAX750AE, 0mA < ILOAD < 300mA for MAX750AM	4.75	5.00	5.25				V
	V+ = 6.0V to 16.0V; 0mA < ILOAD < 450mA for MAX758AC/AE, 0mA < ILOAD < 350mA for MAX758AM				4.75	5.00	5.25	
	V+ = 10.2V to 16.0V, 0mA < ILOAD < 750mA				4.75	5.00	5.25	
Input Voltage Range		4.0		11.0	4.0		16.0	V
Line Regulation	V+ = 4.0V to 11.0V		0.15					%V
	V+ = 4.0V to 16.0V				0.15			
Load Regulation	ILOAD = 0mA to 450mA		0.0005					%mA
	ILOAD = 0mA to 750mA				0.0005			
Efficiency	V+ = 9.0V, ILOAD = 300mA		92			90		%
	V+ = 12V, ILOAD = 750mA					87		
Supply Current			1.7	3.0		1.7	3.0	mA
Shutdown Supply Current (Note 2)	SHDN = 0V		6.0	100.0		6.0	100.0	μA
Shutdown Input Threshold	VIH	2.0			2.0			V
	VIL			0.25			0.25	
Shutdown Input Leakage Current				1.0			1.0	μA
Short-Circuit Current			1.5			1.5		A

Adjustable, Step-Down, Current-Mode PWM Regulators

MAX750A/MAX758A

ELECTRICAL CHARACTERISTICS (continued)

(Circuit of Figure 3, $V_+ = 9V$ for the MAX750A, $V_+ = 12V$ for the MAX758A, $V_{OUT} = 5V$, $R_2 = 40.20k\Omega$, $R_3 = 13.0k\Omega$, $I_{LOAD} = 0mA$, $T_A = T_{MIN}$ to T_{MAX} , unless otherwise noted.)

PARAMETER	CONDITIONS	MAX750A			MAX758A			UNITS
		MIN	TYP	MAX	MIN	TYP	MAX	
Undervoltage Lockout	V_+ rising		3.75	4.00		3.75	4.00	V
	V_+ falling		3.5			3.5		
LX On Resistance	$I_{LX} = 500mA$		0.5			0.5		Ω
LX Leakage Current			1.0			1.0		μA
Reference Voltage	$T_A = +25^\circ C$	1.15	1.22	1.30	1.15	1.22	1.30	V
Reference Drift			50			50		ppm/ $^\circ C$
Oscillator Frequency		130	170	210	130	160	190	kHz
Compensation Pin Impedance			7500			7500		Ω

Note 1: Output voltage tolerance over temperature is $\pm 4.5\%$ plus the tolerances of R3 and R4 in Figure 3.

Note 2: The standby current typically settles to $25\mu A$ (over temperature) within 2 seconds; however, to decrease test time, the part is guaranteed at a $100\mu A$ maximum value.

Typical Operating Characteristics

(Circuit of Figure 3, $V_{OUT} = 5V$, $T_A = +25^\circ C$, unless otherwise noted.)

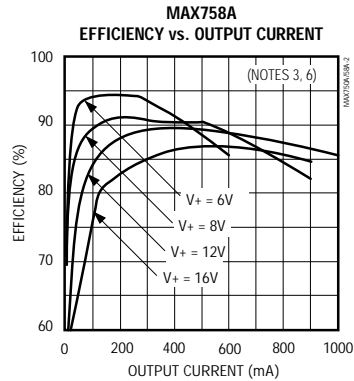
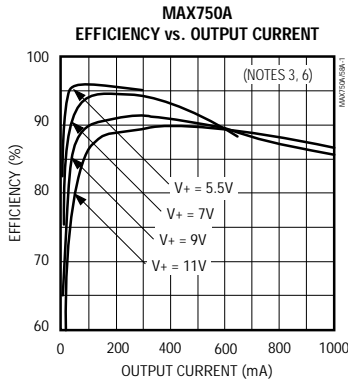

Adjustable, Step-Down, Current-Mode PWM Regulators

Typical Operating Characteristics (continued)

(Circuit of Figure 3, $V_{OUT} = 5V$, $T_A = +25^\circ C$, unless otherwise noted.)

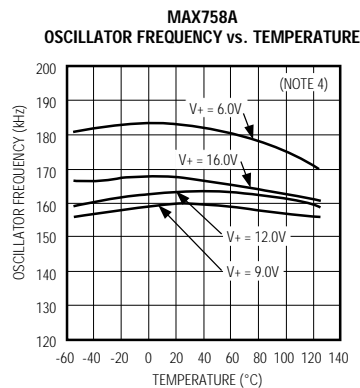
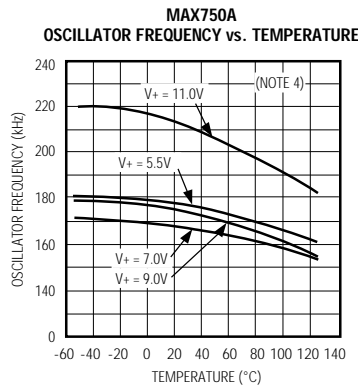
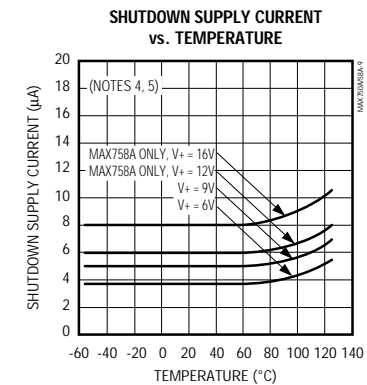
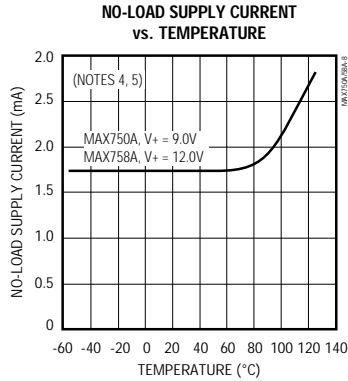
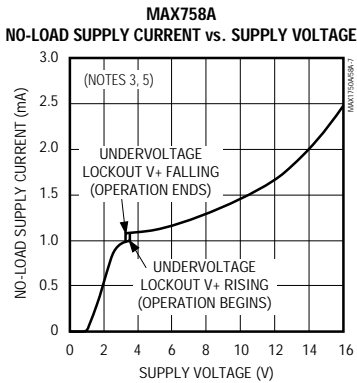
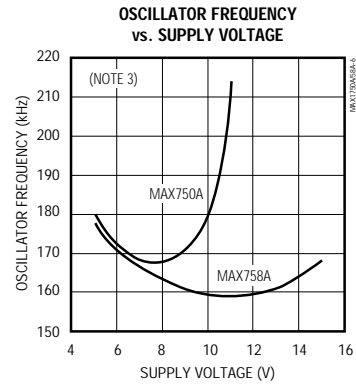
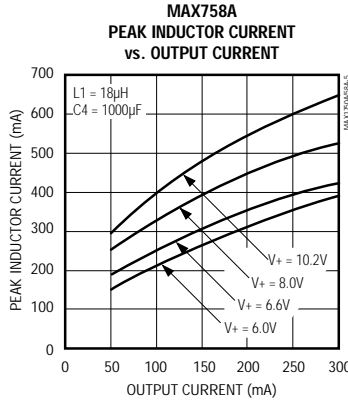
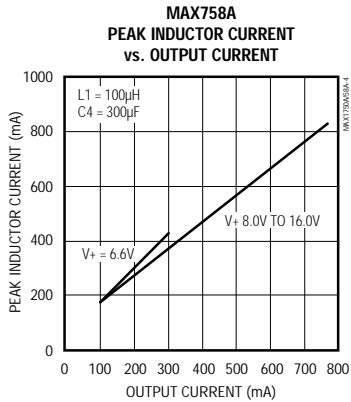

Adjustable, Step-Down, Current-Mode PWM Regulators

Typical Operating Characteristics (continued)

(Circuit of Figure 3, $V_{OUT} = 5V$, $T_A = +25^\circ C$, unless otherwise noted.)

MAX750A/MAX758A

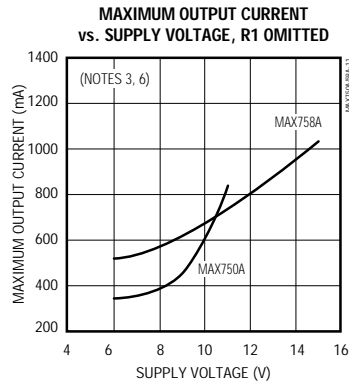
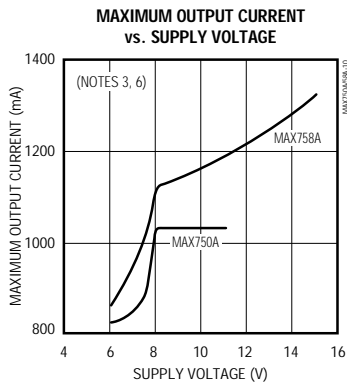

MAX758A SWITCHING WAVEFORMS CONTINUOUS CONDUCTION

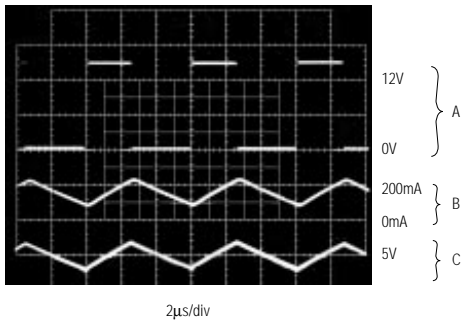

A: SWITCH VOLTAGE (LX PIN), 5V/div, 0V TO +12V
B: INDUCTOR CURRENT, 200mA/div
C: OUTPUT VOLTAGE RIPPLE, 50mV/div

$C_{OUT} = 390\mu F$, $V_+ = 12V$, $I_{OUT} = 150mA$

MAX758A SWITCHING WAVEFORMS DISCONTINUOUS CONDUCTION

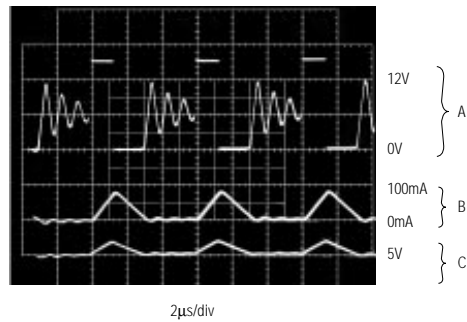

A: SWITCH VOLTAGE (LX PIN), 5V/div, 0V TO +12V
B: INDUCTOR CURRENT, 100mA/div
C: OUTPUT VOLTAGE RIPPLE, 50mV/div

$C_{OUT} = 390\mu F$, $V_+ = 12V$, $I_{OUT} = 20mA$

Adjustable, Step-Down, Current-Mode PWM Regulators

MAX750A/MAX758A

Typical Operating Characteristics (continued)

(Circuit of Figure 3, $V_{OUT} = 5V$, $T_A = +25^\circ C$, unless otherwise noted.)

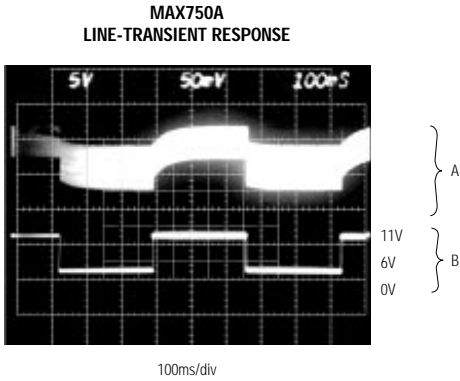

A: V_{OUT} , 50mV/div, AC-COUPLED
B: V_+ , 5V/div, 6.0V TO 11.0V
 $I_{OUT} = 300mA$

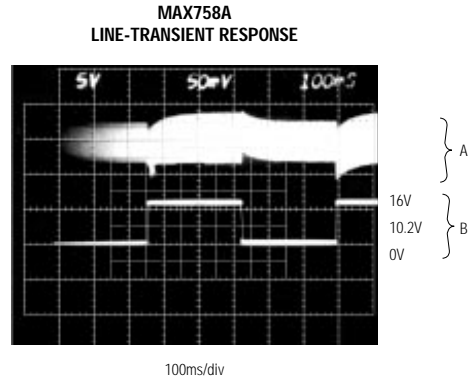

A: V_{OUT} , 50mV/div, AC-COUPLED
B: V_+ , 5V/div, 10.2V TO 16.0V
 $I_{OUT} = 750mA$

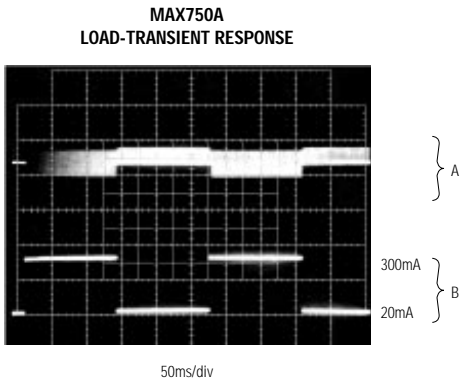

A: V_{OUT} , 50mV/div, AC-COUPLED
B: I_{OUT} , 200mA/div, 20mA TO 300mA
 $V_+ = 9V$

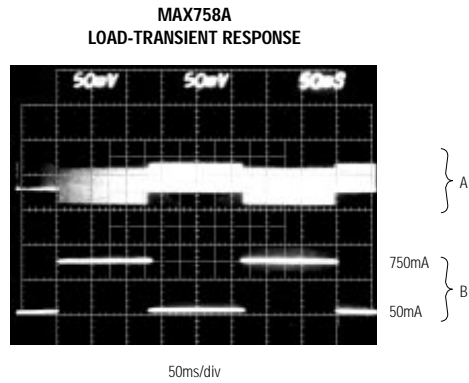

A: V_{OUT} , 50mV/div, AC-COUPLED
B: I_{OUT} , 500mA/div, 50mA TO 750mA
 $V_+ = 12V$

- Note 3:** Commercial temperature range external component values in Table 2.
- Note 4:** Wide temperature range external component values in Table 2.
- Note 5:** Supply current includes all external component leakage currents. External capacitor leakage currents dominate at $T_A > +85^\circ C$.
C3 and C4 = Sanyo Oscon through-hole capacitors.
- Note 6:** Operation beyond the specifications listed in the *Electrical Characteristics* may exceed the power dissipation ratings of the device.

Adjustable, Step-Down, Current-Mode PWM Regulators

Pin Description

MAX750A/MAX758A

PIN		NAME	FUNCTION
8-PIN DIP/SO	16-PIN WIDE SO		
1	2	SHDN	Shutdown—active low. Ground to power-down chip, tie to V+ for normal operation. Output voltage falls to 0V when SHDN is low.
2	3	REF	Reference Voltage Output (+1.22V) supplies up to 100 μ A for external loads. Bypass to GND with a capacitor that does not exceed 0.047 μ F.
3	7	SS	Soft-Start. Capacitor between SS and GND provides soft-start and short-circuit protection. 510k Ω resistor from SS to SHDN provides current boost.
4	8	CC	External voltage divider feedback point. When an external voltage divider is connected from the output voltage to CC and GND, this pin becomes the feedback input for adjusting the output voltage. Connect a 330pF compensation capacitor between the output and CC.
5	9	I.C.	Internal Connection. Make no external connection to this pin.
6	10, 11	GND	Ground*
7	12, 13, 14	LX	Drain of internal P-channel power MOSFET*
8	1, 15, 16	V+	Supply Voltage Input. Bypass to GND with 1.0 μ F ceramic and large-value electrolytic capacitors in parallel. The 1 μ F capacitor must be as close to the V+ and GND pins as possible.*
–	4, 5, 6	N.C.	No Connect—not internally connected.

*16-Pin Wide SO: All pins with the same name must be connected together externally.

Detailed Description

The MAX750A/MAX758A switch-mode regulators use a current-mode pulse-width-modulation (PWM) control system coupled with a simple step-down (buck) regulator topography. Input voltages range from 4V to 11V for the MAX750A, and from 4V to 16V for the MAX758A. The current-mode PWM architecture provides cycle-by-cycle current limiting, improved load transient response characteristics, and simpler outer-loop design.

The controller consists of two feedback loops: an inner (current) loop that monitors the switch current via the current-sense resistor and amplifier, and an outer (voltage) loop that monitors the output voltage through the error amplifier (Figure 1). The inner loop performs cycle-by-cycle current limiting, truncating the power-transistor on-time when the switch current reaches a predetermined threshold. This threshold is determined by the outer loop. For example, a sagging output voltage produces an error signal that raises the threshold, allowing the circuit to store and transfer more energy during each cycle.

Programmable Soft-Start

Figures 1 and 2 show a capacitor and a resistor connected to the soft-start (SS) pin to ensure an orderly power-up. Typical values are 0.1 μ F and 510k Ω . SS controls both the soft-start timing and the maximum output current that can be delivered while maintaining regulation.

The charging capacitor slowly raises the clamp on the error-amplifier output voltage, limiting surge currents at power-up by slowly increasing the cycle-by-cycle current-limit threshold. The 510k Ω resistor sets the soft-start clamp at a value high enough to maintain regulation, even at currents exceeding 1A. This resistor is not necessary for lower current loads. Refer to the Maximum Output Current vs. Supply Voltage, No. R1 graph in the *Typical Operating Characteristics*. Table 1 lists timing characteristics for selected capacitor values and circuit conditions.

The overcurrent comparator trips if the load exceeds approximately 1.5A. A soft-start cycle begins when either an undervoltage or overcurrent fault condition triggers an internal transistor to discharge the soft-start capacitor to ground. A soft-start cycle also begins at power-up and when coming out of the shutdown mode.

Adjustable, Step-Down, Current-Mode PWM Regulators

MAX750A/MAX758A

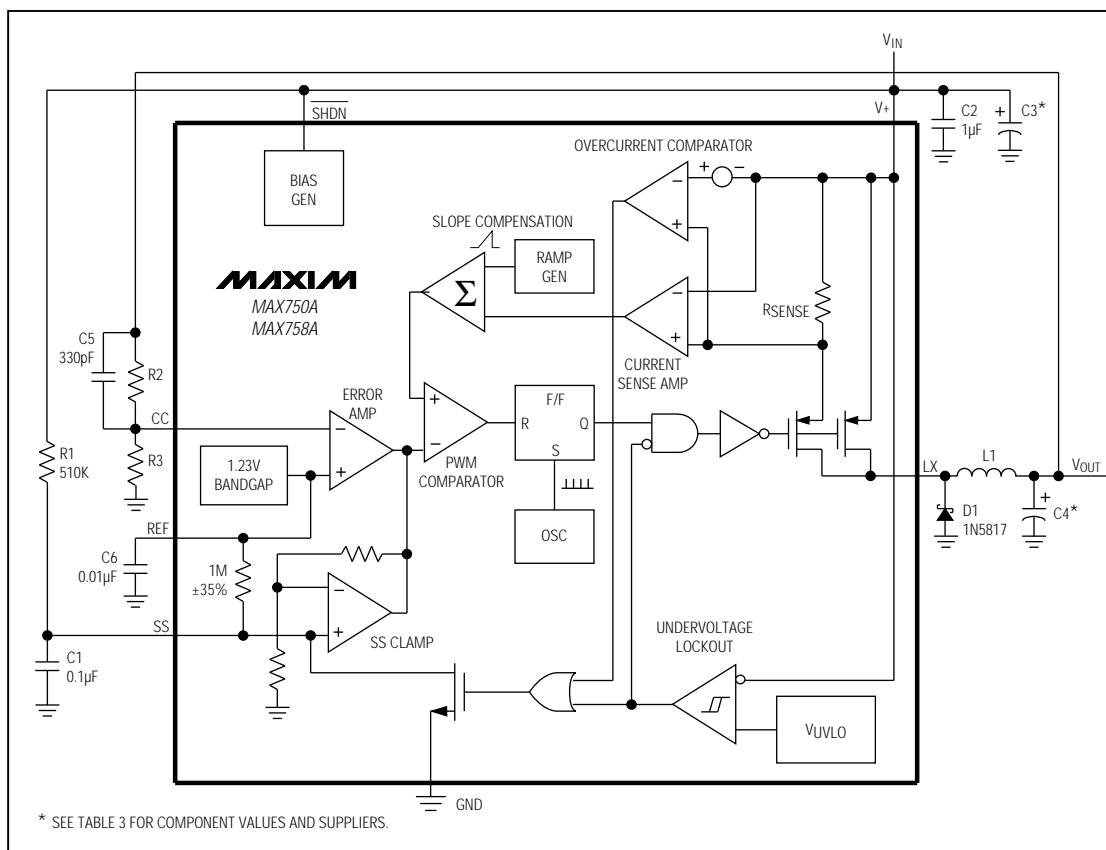

Figure 1. Detailed Block Diagram with External Components

Overcurrent Limiting

The overcurrent comparator triggers when the load current exceeds approximately 1.5A. On each clock cycle, the output FET turns on and attempts to deliver current until cycle-by-cycle or overcurrent limits are exceeded. Note that the soft-start capacitor must be greater than 0.01µF for overcurrent protection to function properly. A typical value is 0.1µF. A soft-start cycle is initiated when the overcurrent comparator is triggered.

Undervoltage Lockout

The undervoltage lockout feature monitors the supply voltage at V+ and allows operation to start when V+ rises above 3.75V. When V+ falls, operation continues until the supply voltage falls below 3.50V. When an

undervoltage condition is detected, control logic turns off the output power FET and discharges the soft-start capacitor to ground. This prevents partial turn-on of the power MOSFET and avoids excessive power dissipation. The control logic holds the output power FET off until the supply voltage rises above approximately 3.75V, at which time a soft-start cycle begins.

Shutdown Mode

The MAX750A/MAX758A are shut down by keeping SHDN at ground. In shutdown mode, the output power FET is held off and the output drops to 0V. The internal reference also turns off, which causes the soft-start capacitor to discharge. The 6µA typical standby current includes external-component leakage currents. As temperature increases past +85°C, the external capaci-

Adjustable, Step-Down, Current-Mode PWM Regulators

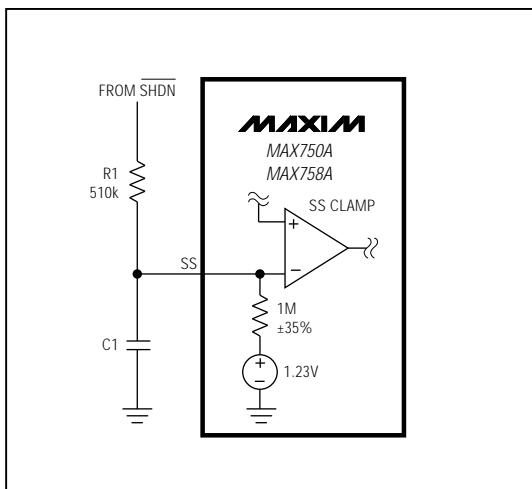

Figure 2. Block Diagram of Soft-Start Circuitry

tors' leakage currents rises sharply. The actual design limit for standby current is much less than the 100 μ A specified in the *Electrical Characteristics* (see the Standby Current vs. Temperature graph in the *Typical Operating Characteristics*). However, testing to tighter limits is prohibitive because the current takes several seconds to settle to a final value. For normal operation, connect **SHDN** to V+. Coming out of shutdown mode initiates a soft-start cycle.

Continuous-/Discontinuous- Conduction Modes

The input voltage, output voltage, load current, and inductor value determine whether the IC operates in continuous or discontinuous mode. As the inductor value or load current decreases, or the input voltage increases, the MAX750A/MAX758A tend to operate in discontinuous-conduction mode (DCM). In DCM, the inductor-current slope is steep enough so it decays to zero before the end of the transistor off-time. In continuous-conduction mode (CCM), the inductor current never decays to zero, which is typically more efficient than DCM. CCM allows the MAX750A/MAX758A to deliver maximum load current, and is also slightly less noisy than DCM because the ripple current in the output capacitor is smaller.

Internal Reference

The +1.23V bandgap reference supplies up to 100 μ A at REF. Connect a 0.01 μ F bypass capacitor from REF to GND.

Oscillator

The internal oscillator of the MAX750A typically operates at 170kHz (160kHz for the MAX758A). The *Typical Operating Characteristics* indicate stability of the oscillator frequency over temperature and supply voltage.

Applications Information

Figure 3 shows the MAX750A/MAX758A configured for a standard 5V step-down application. Table 2 lists the components for the desired operating temperature range. These circuits are useful in systems that require high current at high efficiency and are powered by an unregulated supply, such as a battery or wall-plug AC-DC transformer. They will operate over the entire line, load, and temperature ranges using the single set of component values shown in Figure 3 and listed in Table 2.

Inductor Selection

The MAX750A/MAX758A require no inductor design because they are tested in-circuit, and are guaranteed to deliver the power specified in the *Electrical Characteristics* with high efficiency using a single 100 μ H (MAX75_AC) or 33 μ H (MAX75_AE/AM) inductor. The inductor's incremental saturation-current rating should be greater than 1A, and its DC resistance should be less than 0.8 Ω . Table 2 lists inductor types and suppliers for various applications. The surface-mount inductors and the larger-size through-hole inductors have nearly equivalent efficiencies.

Adjusting the Output Voltage

The MAX750A/MAX758A have outputs adjustable from 1.25V to the input voltage. To set the output voltage, connect a voltage divider to the feedback input pin (CC) as shown in Figure 3. The output voltage is set by R2 and R3 as follows:

Let R3 be any resistance in the 10k Ω to 20k Ω range (typically 10k Ω), then

$$R2 = R3 [((V_{OUT}/1.22V) - 1)]$$

Output tolerance over temperature is $\pm 4.5\%$ plus external resistor tolerances.

Output Filter Capacitor Selection

The primary criterion for selecting the output filter capacitor is low equivalent series resistance (ESR). The product of the inductor-current variation and the ESR of the output capacitor determines the amplitude of the sawtooth ripple seen on the output voltage. In addition, the ESR of the output filter capacitor should be minimized to maintain AC stability. The ESR of the capacitor should be less than 0.25 Ω to keep the output ripple less than 50mVp-p over the entire current range (using a 100 μ H inductor). Capacitor ESR usually rises

MAX750A/MAX758A

Adjustable, Step-Down, Current-Mode PWM Regulators

MAX750A/MAX758A

Table 1. Typical Soft-Start Times

MAX750A CIRCUIT CONDITIONS				SOFT-START TIME (ms) vs. C1 (μF)			
R1 (kΩ)	V+ (V)	I _{OUT} (mA)	C4 (μF)	C1 = 0.01	C1 = 0.047	C1 = 0.1	C1 = 0.47
510	6	0	100	2	6	11	28
510	9	0	100	1	4	6	15
510	11	0	100	1	2	4	11
510	9	150	100	1	4	8	21
510	9	300	100	1	5	9	27
510	9	150	390	3	6	9	23
510	9	150	680	4	6	9	24
None	6	0	100	16	34	51	125
None	9	0	100	10	22	34	82
None	11	0	100	8	18	28	66
None	9	150	100	34	134	270	1263
None	9	150	390	39	147	280	1275
None	9	150	680	40	152	285	1280

MAX750A CIRCUIT CONDITIONS				SOFT-START TIME (ms) vs. C1 (μF)			
R1 (kΩ)	V+ (V)	I _{OUT} (mA)	C4 (μF)	C1 = 0.01	C1 = 0.047	C1 = 0.1	C1 = 0.47
510	7	0	100	1	4	6	18
510	12	0	100	1	2	3	8
510	16	0	100	1	1	2	6
510	12	300	100	1	3	5	3
510	12	750	100	1	5	8	21
None	7	0	100	12	27	40	100
None	12	0	100	7	16	25	54
None	16	0	100	6	13	20	68
None	12	300	100	27	112	215	1114

as the temperature falls, and excessive ESR is the most likely cause of trouble at temperatures below 0°C. Sanyo OS-CON series through-hole and surface-mount tantalum capacitors exhibit low ESR at temperatures below 0°C. Refer to Table 2 for recommended capacitor values and suggested capacitor suppliers.

Other Components

The catch diode should be a Schottky or high-speed silicon rectifier with a peak current rating of about 1A for full-load (750mA) operation. The 1N5817 is a good choice. The 330pF outer-loop compensation capacitor

provides the widest input voltage range and best transient characteristics. For low-current applications, the 510kΩ resistor may be omitted (see the Maximum Output Current vs. Supply Voltage, R1 Removed graph in the *Typical Operating Characteristics*).

Printed Circuit Layouts

A good layout is essential for clean, stable operation. The layouts and component placement diagrams given in Figures 4-7 have been successfully tested over a wide range of operating conditions. **The 1μF bypass capacitor (C2) must be positioned as close to the V+**

Adjustable, Step-Down, Current-Mode PWM Regulators

MAX750A/MAX758A

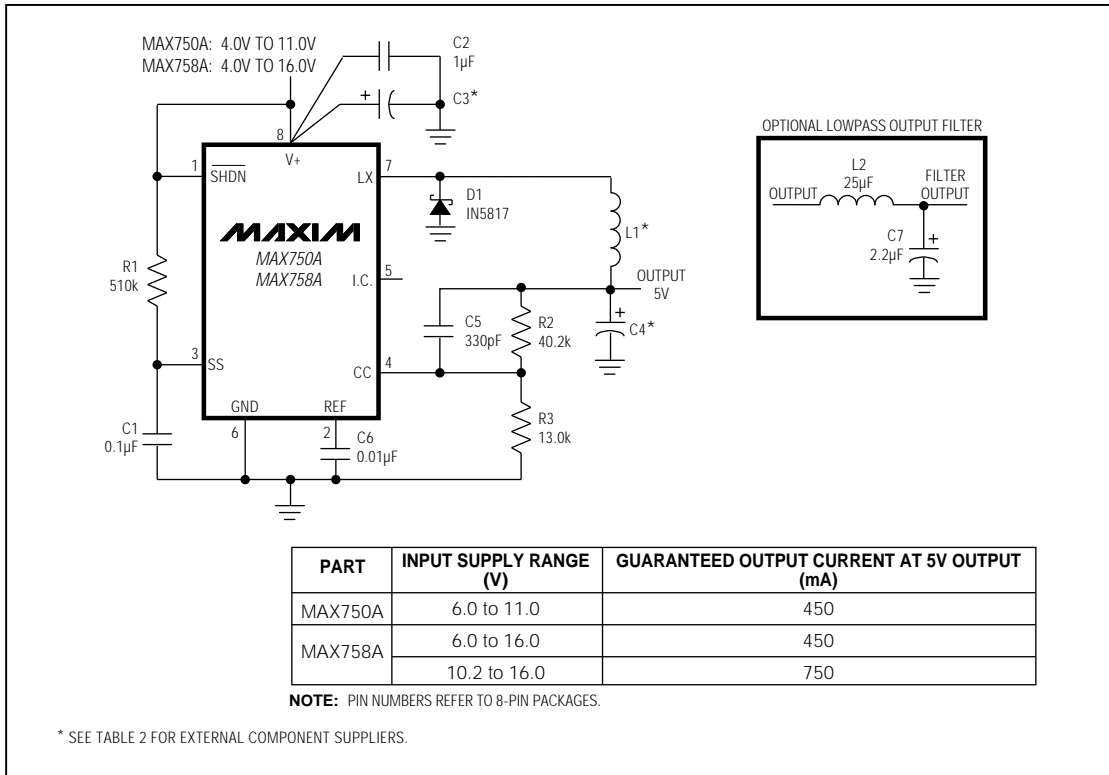

Figure 3. Standard Step-Down Circuit

and GND pins as possible. Also, place the output capacitor as close to the inductor and the GND pin as possible. The traces connecting the input and output filter capacitors and the catch diode must be short to minimize inductance and capacitance. For this reason, avoid using sockets, and solder the IC directly to the PC board. Use an uninterrupted ground plane if possible; otherwise, use a star ground connection.

Output-Ripple Filtering

A simple lowpass pi-filter (Figure 3) can be added to the output to reduce output ripple to about 5mVp-p. The cutoff frequency with the values shown is 21kHz. Since the filter inductor is in series with the circuit output, its resistance should be kept to a minimum so the voltage drop across it is not excessive.

Adjustable, Step-Down, Current-Mode PWM Regulators

MAX750A/MAX758A

Table 2. Component Values and Suppliers

ASSEMBLY METHOD	MAX750AC/MAX758AC COMMERCIAL TEMPERATURE RANGE		MAX750AE/M, MAX758AE/M WIDE TEMPERATURE RANGE	
	INDUCTORS	CAPACITORS	INDUCTORS	CAPACITORS
Surface Mount	L1 = 33 μ H to 100 μ H Sumida (708) 956-0666 CD54-101KC (MAX750AC) CD105-101KC (MAX758AC) Coiltronics (305) 781-8900 CTX100 series	C3 = 68 μ F, 16V C4 = 100 μ F, 6.3V Matsuo (714) 969-2491 267 series Sprague (603) 224-1961 595D/293D series	L1 = 33 μ H Sumida (708) 956-0666 CD54-33ON (MAX750AC) CD105-33ON (MAX758AE/M) Coiltronics (305) 781-8900 CTX50 series	C3 = 68 μ F, 16V C4 = 100 μ F, 6.3V Matsuo (714) 969-2491 267 series Sprague (603) 224-1961 595D/295D series
Miniature Through-Hole	L1 = 33 μ H to 100 μ H Sumida (708) 956-0666 RCH654-101K (MAX750A) RCH895-101K (MAX758A)	C3 = 150 μ F, 16V C4 = 150 μ F, 16V or 390 μ F, 6.3V Nichicon (708) 843-7500 PL series Low-ESR electrolytics	L1 = 33 μ H Sumida (708) 956-0666 RCH654-330M (MAX750A) RCH895-330M (MAX758A)	C3 = 150 μ F, 16V C4 = 220 μ F, 10V Sanyo (619) 661-6322 OS-CON series Low-ESR organic semiconductor (Rated from -55°C to +105°C) Mallory (317) 273-0090 THF series C3 = 100 μ F, 20V C4 = 220 μ F, 10V (Rated from -55°C to +125°C)
Low-Cost Through-Hole	L1 = 100 μ H Maxim MAXL001 100 μ H iron-powder toroid Renco (516) 586-5566 RL1284-100	C3 = 150 μ F, 16V C4 = 390 μ F, 6.3V Maxim MAXC001 150 μ F, low-ESR electrolytic United Chemicon (708) 843-7500		

Adjustable, Step-Down, Current-Mode PWM Regulators

MAX750A/MAX758A

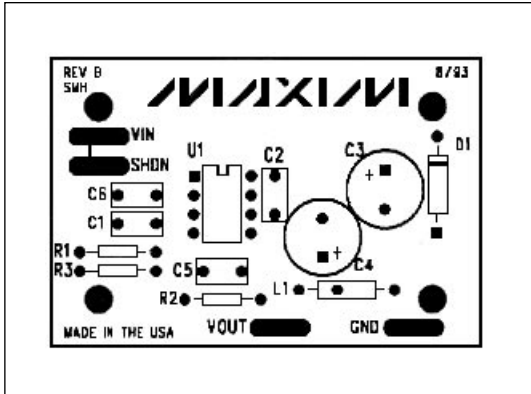

Figure 4. DIP PC Layout, Through-Hole Component Placement Diagram (1x Scale)

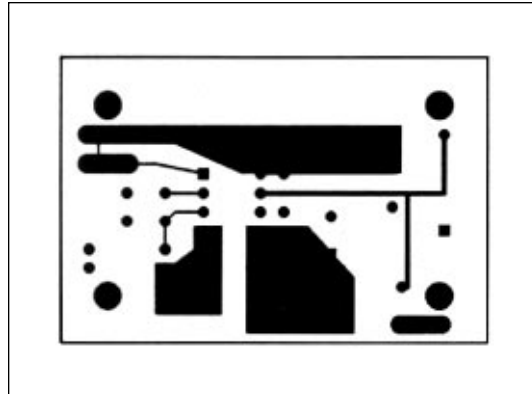

Figure 5. DIP PC Layout, Component Side (1x Scale)

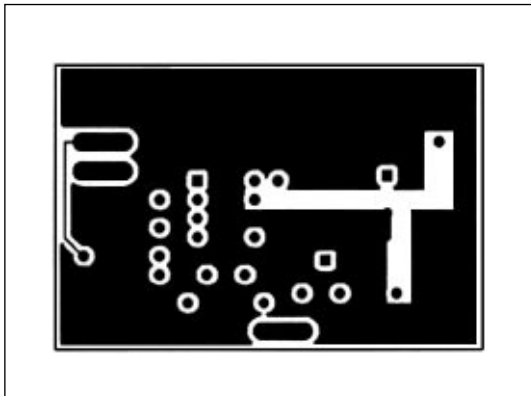

Figure 6. DIP PC Layout, Solder Side (1x Scale)

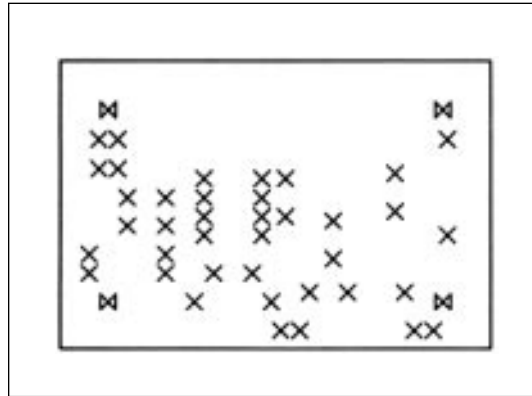
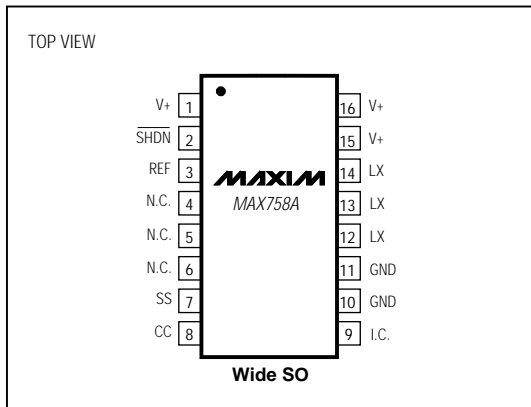

Figure 7. DIP PC Layout, Drill Guide (1x Scale)

MAX750A/MAX758A

Adjustable, Step-Down, Current-Mode PWM Regulators

Pin Configurations (continued)



Ordering Information (continued)

PART	TEMP. RANGE	PIN-PACKAGE
MAX758ACPA	0°C to +70°C	8 Plastic DIP
MAX758ACWE	0°C to +70°C	16 Wide SO
MAX758AC/D	0°C to +70°C	Dice*
MAX758AEPA	-40°C to +85°C	8 Plastic DIP
MAX758AEWE	-40°C to +85°C	16 Wide SO
MAX758AMJA	-55°C to +125°C	8 CERDIP**

* Contact factory for dice specifications.

**Contact factory for availability and processing to MIL-STD-883.

Chip Topographies

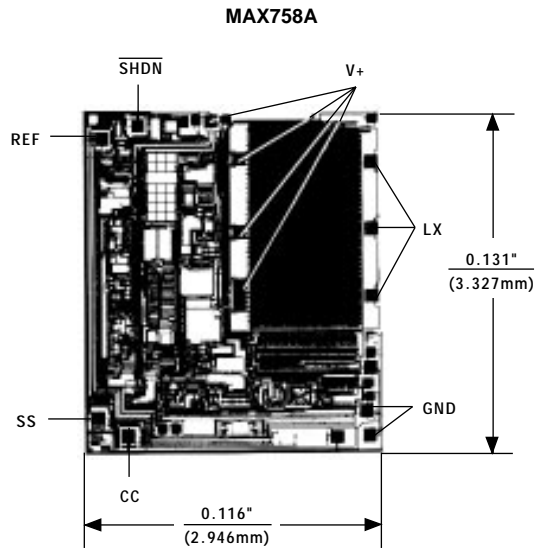
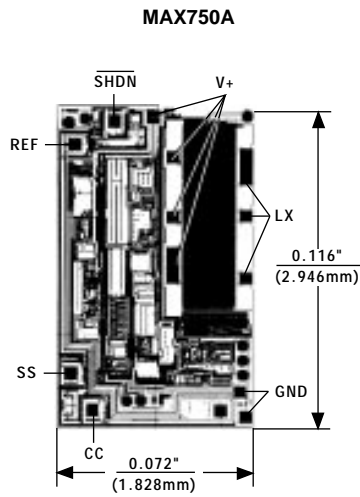

TRANSISTOR COUNT: 274 (MAX750A)
286 (MAX758A);
SUBSTRATE CONNECTED TO V+.

Adjustable, Step-Down, Current-Mode PWM Regulators

Package Information

MAX750A/MAX758A

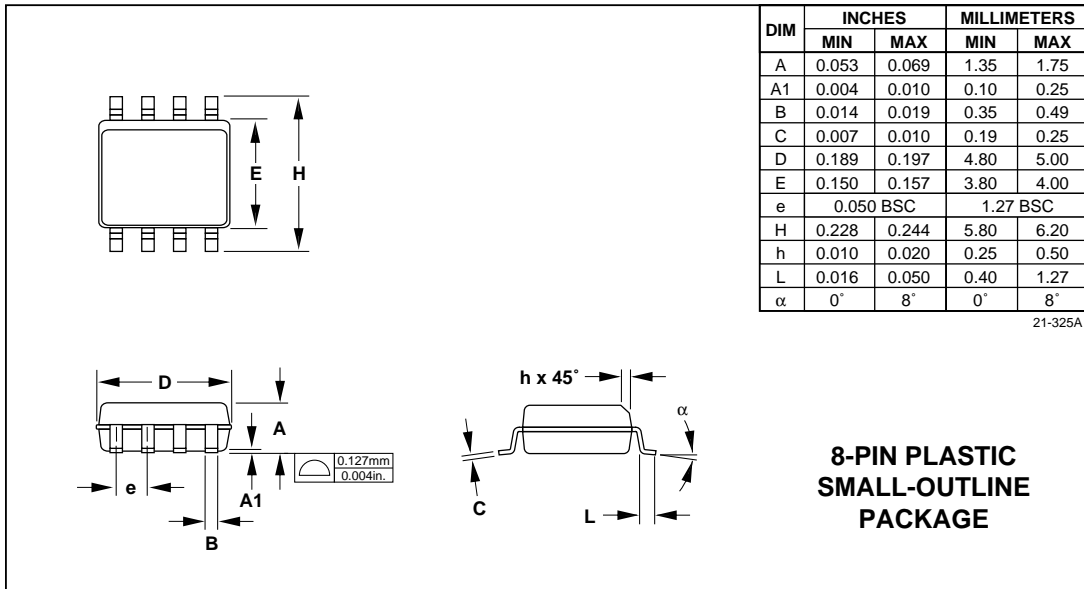
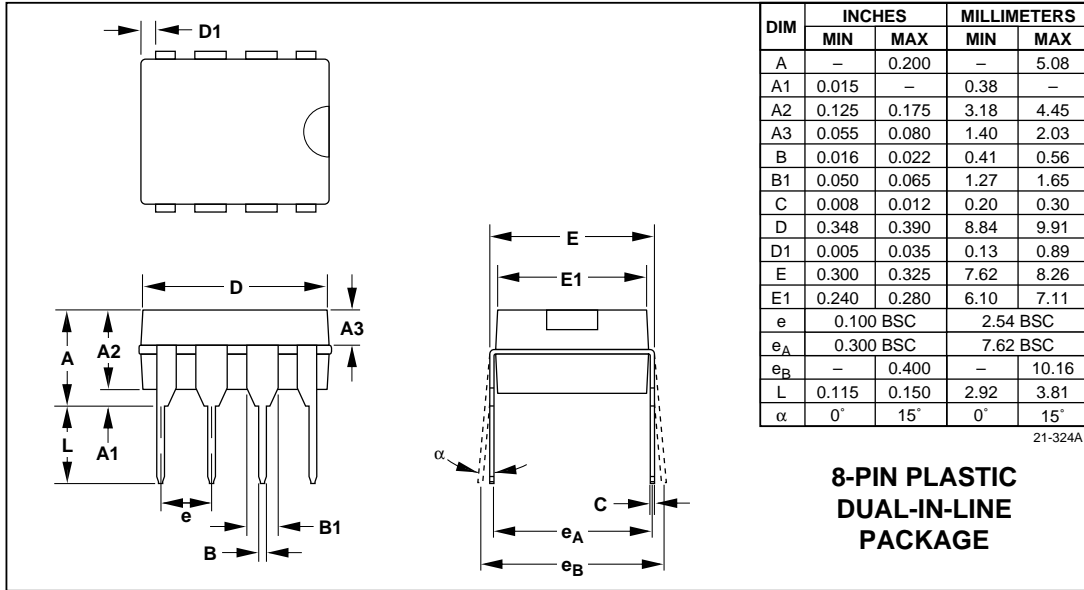

Adjustable, Step-Down, Current-Mode PWM Regulators

Package Information (continued)

MAX750A/MAX758A

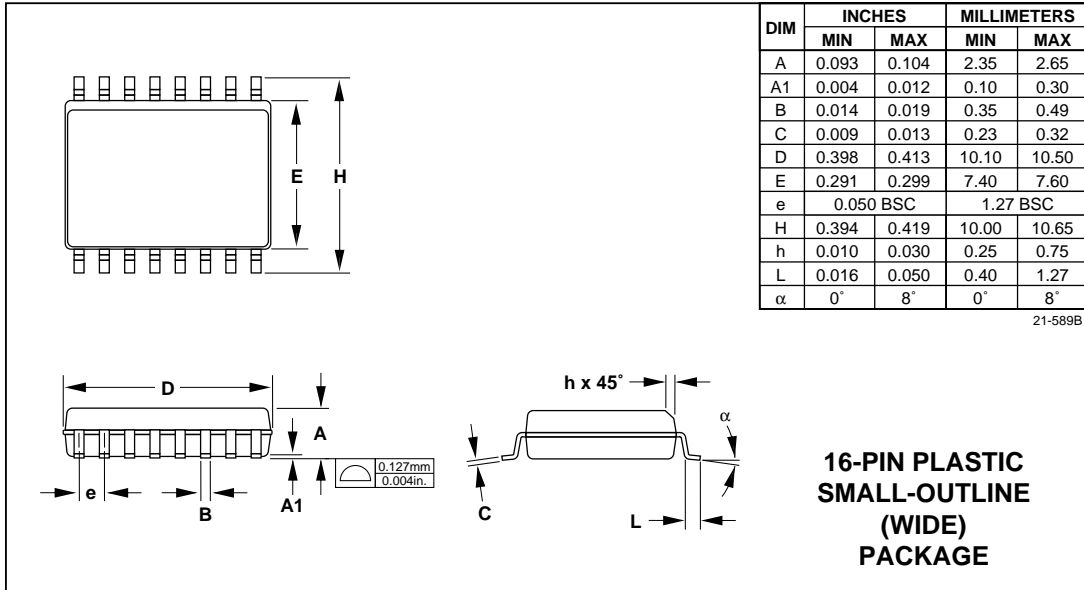

Maxim cannot assume responsibility for use of any circuitry other than circuitry entirely embodied in a Maxim product. No circuit patent licenses are implied. Maxim reserves the right to change the circuitry and specifications without notice at any time.

16 Maxim Integrated Products, 120 San Gabriel Drive, Sunnyvale, CA 94086 (408) 737-7600

© 1993 Maxim Integrated Products

Printed USA

MAXIM is a registered trademark of Maxim Integrated Products.

OUR CERTIFICATE

DiGi provide top-quality products and perfect service for customer worldwide through standardization, technological innovation and continuous improvement. DiGi through third-party certification, we strictly control the quality of products and services. Welcome your RFQ to

Email: Info@DiGi-Electronics.com



Tel: +00 852-30501935

RFQ Email: Info@DiGi-Electronics.com

DiGi is a global authorized distributor of electronic components.