

# MAX977EEE Datasheet

[www.digi-electronics.com](http://www.digi-electronics.com)

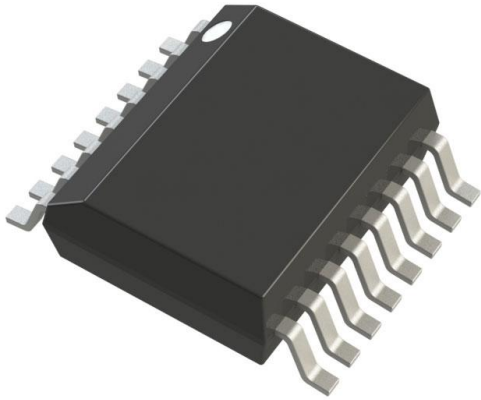

<https://www.DiGi-Electronics.com>

DiGi Electronics Part Number	MAX977EEE-DG
Manufacturer	<a href="#">Analog Devices Inc./Maxim Integrated</a>
Manufacturer Product Number	MAX977EEE
Description	IC COMPARATOR 2 GEN PUR 16QSOP
Detailed Description	Comparator General Purpose CMOS, Rail-to-Rail, T TL 16-QSOP



Tel: +00 852-30501935

RFQ Email: [Info@DiGi-Electronics.com](mailto:Info@DiGi-Electronics.com)

DiGi is a global authorized distributor of electronic components.

## Purchase and inquiry

Manufacturer Product Number:

MAX977EEE

Series:

-

Type:

General Purpose

Output Type:

CMOS, Rail-to-Rail, TTL

Voltage - Input Offset (Max):

2mV @ 5V

Current - Output (Typ):

-

CMRR, PSRR (Typ):

82dB CMRR, 90dB PSRR

Hysteresis:

4mV

Package / Case:

16-SSOP (0.154", 3.90mm Width)

Supplier Device Package:

16-QSOP

Manufacturer:

Analog Devices Inc./Maxim Integrated

Product Status:

Obsolete

Number of Elements:

2

Voltage - Supply, Single/Dual ( $\pm$ ):

2.7V ~ 5.25V

Current - Input Bias (Max):

0.1 $\mu$ A @ 5.25V

Current - Quiescent (Max):

500 $\mu$ A

Propagation Delay (Max):

820ns

Operating Temperature:

-40°C ~ 85°C

Mounting Type:

Surface Mount

Base Product Number:

MAX977

## Environmental & Export classification

RoHS Status:

RoHS non-compliant

REACH Status:

REACH Unaffected

HTSUS:

8542.39.0001

Moisture Sensitivity Level (MSL):

1 (Unlimited)

ECCN:

EAR99



# Single/Dual, +3V/+5V Dual-Speed Comparators with Auto-Standby

MAX975/MAX977

## ABSOLUTE MAXIMUM RATINGS

Supply Voltage (V <sub>CC</sub> ) .....	+6V	8-Pin $\mu$ MAX (derate 4.10mW/°C above +70°C) .....	330mW
All Other Pins .....	-0.3V to (V <sub>CC</sub> + 0.3V)	14-Pin SO (derate 8.33mW/°C above +70°C) .....	667mW
Current into Input Pins .....	$\pm 20$ mA	16-Pin QSOP (derate 8.33mW/°C above +70°C) .....	667mW
Duration of Output Short Circuit to GND <sub>-</sub> or V <sub>CC</sub> .....	Continuous	Operating Temperature Range .....	-40°C to +85°C
Continuous Power Dissipation (T <sub>A</sub> = +70°C)		Storage Temperature Range .....	-65°C to +150°C
8-Pin SO (derate 5.88mW/°C above +70°C) .....	471mW	Lead Temperature (soldering, 10sec) .....	+300°C

Stresses beyond those listed under "Absolute Maximum Ratings" may cause permanent damage to the device. These are stress ratings only, and functional operation of the device at these or any other conditions beyond those indicated in the operational sections of the specifications is not implied. Exposure to absolute maximum rating conditions for extended periods may affect device reliability.

## ELECTRICAL CHARACTERISTICS

(V<sub>CC</sub> = +2.7V to +5.25V, specifications are for high-speed mode, T<sub>A</sub> = -40°C to +85°C, unless otherwise noted. Typical values are at T<sub>A</sub> = +25°C.) (Note 1)

PARAMETER	SYMBOL	CONDITIONS		MIN	TYP	MAX	UNITS
<b>POWER SUPPLY</b>							
Supply-Voltage Operating Range	V <sub>CC</sub>			2.7		5.25	V
Supply Current Per Comparator	I <sub>CC</sub>	High-speed mode			250	500	$\mu$ A
		Auto-standby/low-power modes	SO		3	5	
				$\mu$ MAX/QSOP		3	6
Power-Supply Rejection Ratio	PSRR	V <sub>CM</sub> = 1V, 2.7V $\leq$ V <sub>CC</sub> $\leq$ 5.25V	High-speed mode	63	90		dB
			Low-power mode		77		
<b>COMPARATOR INPUTS</b>							
Common-Mode Voltage Range	V <sub>CMR</sub>	(Note 2)		-0.2		V <sub>CC</sub> - 1.2	V
Input Offset Voltage (Note 3)	V <sub>OS</sub>	V <sub>CM</sub> = 1V, V <sub>CC</sub> = 5V	High-speed mode, T <sub>A</sub> = +25°C		+0.2	$\pm 2$	mV
			High-speed mode, T <sub>A</sub> = T <sub>MIN</sub> to T <sub>MAX</sub>			$\pm 3$	
			Auto-standby/ low-power modes, T <sub>A</sub> = T <sub>MIN</sub> to T <sub>MAX</sub>	SO		$\pm 1$	
$\mu$ MAX/QSOP		$\pm 1$		$\pm 7$			
Input-Referred Hysteresis	V <sub>HYS</sub>	V <sub>CM</sub> = 1V, V <sub>CC</sub> = 5V (Note 4)	SO	0.5	2	4	mV
			$\mu$ MAX/QSOP	0.3	2	4	
Input Bias Current	I <sub>B</sub>	High-speed mode	SO	-100	-300		nA
			$\mu$ MAX/QSOP	-100	-400		
		Auto-standby/low-power modes		-5			
Input Offset Current	I <sub>OS</sub>				$\pm 20$	$\pm 100$	nA
Input Capacitance	C <sub>IN</sub>				3		pF
Common-Mode Rejection Ratio	CMRR	-0.2V $\leq$ V <sub>CM</sub> $\leq$ V <sub>CC</sub> - 1.2V	High-speed mode	SO	66	90	dB
				$\mu$ MAX/QSOP	54		
			Low-power mode		82		

# Single/Dual, +3V/+5V Dual-Speed Comparators with Auto-Standby

MAX975/MAX977

## ELECTRICAL CHARACTERISTICS (continued)

( $V_{CC} = +2.7V$  to  $+5.25V$ , specifications are for high-speed mode,  $T_A = -40^{\circ}C$  to  $+85^{\circ}C$ , unless otherwise noted. Typical values are at  $T_A = +25^{\circ}C$ .) (Note 1)

PARAMETER	SYMBOL	CONDITIONS		MIN	TYP	MAX	UNITS
<b>DIGITAL INPUTS</b>							
LP Input Voltage High	$V_{LPIH}$			$0.7 \times V_{CC}$	$V_{CC} / 2$		V
LP Input Voltage Low	$V_{LPIL}$				$V_{CC} / 2$	$0.3 \times V_{CC}$	V
LP Fall Time	$t_{LP}$	(Note 5)				10	$\mu s$
LP Input Current	$I_{LPB}$				0.01	$\pm 1$	$\mu A$
STO_ Input Voltage Low	$V_{CIL}$				$V_{CC} / 2$	$0.3 \times V_{CC}$	V
STO_ Source Current	$I_{STO}$	$V_{CC} = 3V$			0.15		$\mu A$
<b>DIGITAL OUTPUTS</b>							
OUT_ Output Voltage High	$V_{OH}$	$I_{SOURCE} = 2mA$ , all modes		$V_{CC} - 0.4$	$V_{CC} - 0.1$		V
OUT_ Output Voltage Low	$V_{OL}$	$I_{SINK} = 2mA$ , all modes			0.1	0.4	V
Propagation Delay, Low to High (Note 6)	$t_{PD+}$	$C_{LOAD} = 10pF$ , $V_{CC} = 5V$	High-speed mode, overdrive = 5mV		28	50	ns
			Low-power mode, overdrive = 10mV		0.82	1.6	$\mu s$
Propagation Delay, High to Low (Note 6)	$t_{PD-}$	$C_{LOAD} = 10pF$ , $V_{CC} = 5V$	High-speed mode, overdrive = 5mV		28	50	ns
			Low-power mode, overdrive = 10mV		0.48	1.6	$\mu s$
Propagation-Delay Skew (Note 6)	$t_{SKEW}$	$C_{LOAD} = 10pF$			2		ns
Propagation-Delay Matching	$\Delta t_{PD}$	MAX977 only, $C_{LOAD} = 10pF$			1		ns
Rise/Fall Time		$C_{LOAD} = 10pF$ , $V_{CC} = 5.0V$	High-speed mode		1.6		ns
			Low-power mode		1.6		
STAT_ Output Voltage High	$V_{SH}$	$I_{SOURCE} = 3mA$ , all modes		$V_{CC} - 0.4$			V
STAT_ Output Voltage Low	$V_{SL}$	$I_{SINK} = 400\mu A$ , all modes				0.4	V

**Note 1:** The MAX975EUA is 100% production tested at  $T_A = +25^{\circ}C$ ; all temperature specifications are guaranteed by design.

**Note 2:** Inferred by CMRR. Either input can be driven to the absolute maximum limit without false output inversion, as long as the other input is within the specified common-mode input voltage range.

**Note 3:**  $V_{OS}$  is defined as the mean of trip points. The trip points are the extremities of the differential input voltage required to make the comparator output change state (Figure 1).

**Note 4:** The difference between the upper and lower trip points is equal to the width of the input-referred hysteresis zone (Figure 1).

**Note 5:** Guaranteed by design. The LP pin is sensitive to noise. If fall times larger than  $10\mu s$  are expected, bypass LP to ground using a  $0.1\mu F$  capacitor.

**Note 6:** Propagation delay is guaranteed by design. For low-overdrive conditions,  $V_{OS}$  is added to the overdrive. The following equation defines propagation-delay skew:  $t_{SKEW} = t_{PD+} - t_{PD-}$ .

# Single/Dual, +3V/+5V Dual-Speed Comparators with Auto-Standby

MAX975/MAX977

## ELECTRICAL CHARACTERISTICS (continued)

( $V_{CC} = +2.7V$  to  $+5.25V$ , specifications are for high-speed mode,  $T_A = -40^{\circ}C$  to  $+85^{\circ}C$ , unless otherwise noted. Typical values are at  $T_A = +25^{\circ}C$ .) (Note 1)

PARAMETER	SYMBOL	CONDITIONS	MIN	TYP	MAX	UNITS
<b>AUTO-STANDBY/LOW-POWER TIMING</b> (Note 7; Figure 2)						
Auto-Standby Timeout	$t_{ASB}$	(Note 8)	5	10	16	ms
Auto-Standby Enable Time	$t_{ASBE}$	(Note 9)		3		$\mu s$
Auto-Standby Wake-Up Time	$t_{ASD}$	10mV overdrive (Note 10)		2	4	$\mu s$
Auto-Standby Wake-Up Input or LP Pulse Width	$t_{PWD}$	10mV overdrive (Note 11)	1.6			$\mu s$
Auto-Standby Comparator Disable	$t_{ASCD}$	(Note 12)		0.8		$\mu s$
Low-Power Enable Time	$t_{LPE}$	(Note 13)		3		$\mu s$
High-Speed Enable Time	$t_{HSE}$	(Note 14)		1.1	4	$\mu s$
Low-Power Comparator Disable	$t_{LPCD}$	(Note 15)		0.7		$\mu s$
Low-Power STAT_High	$t_{LPSH}$	(Note 16)		20		ns

**Note 7:** Timing specifications are guaranteed by design.

**Note 8:** Set by 1000pF external capacitor at the STO\_ pin.  $t_{ASB}$  is defined as the time from last input transition to STAT\_ = high. Does not include time to go into standby condition ( $t_{ASBE}$ ).

**Note 9:**  $t_{ASBE}$  is defined as the time from when STAT\_ goes high to when the supply current drops to 5 $\mu A$ .

**Note 10:**  $t_{ASD}$  is defined as the time from the last input transition to when STAT\_ goes low. The comparator is in high-speed mode before STAT\_ is low.

**Note 11:**  $t_{PWD}$  is defined as the minimum input or LP pulse width to trigger fast-mode operation from auto-standby.

**Note 12:**  $t_{ASCD}$  is defined as the time from the last input transition to when the supply current increases to 300 $\mu A$ .

**Note 13:**  $t_{LPE}$  is defined as the time from when LP is driven high to when the supply current drops to 5 $\mu A$ .

**Note 14:**  $t_{HSE}$  is defined as the time from when LP goes low to when STAT goes low. The comparator is in high-speed mode before STAT\_ is low.

**Note 15:**  $t_{LPCD}$  is defined as the time from when LP goes low to when the supply current increases to 300 $\mu A$ .

**Note 16:**  $t_{LPSH}$  is defined as the time from when LP goes high to when STAT\_ goes high.

# Single/Dual, +3V/+5V Dual-Speed Comparators with Auto-Standby

## Typical Operating Characteristics

( $V_{CC} = 3.0V$ ,  $T_A = +25^\circ C$ , unless otherwise noted.)

MAX975/MAX977

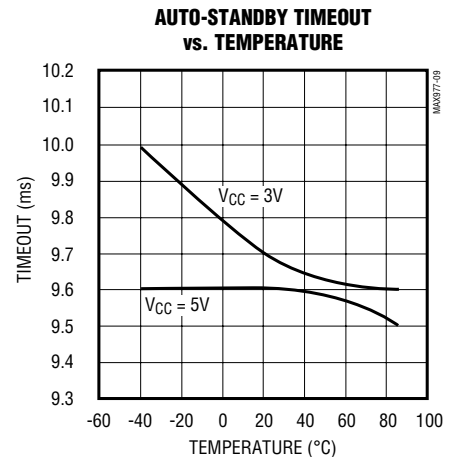
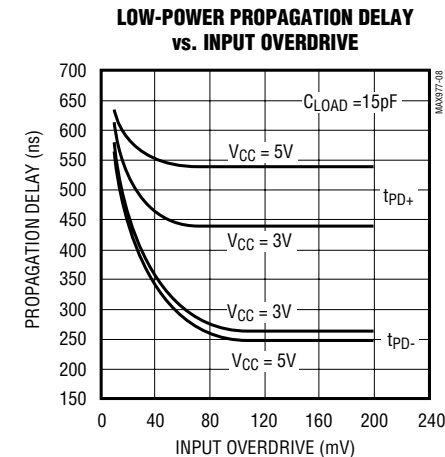
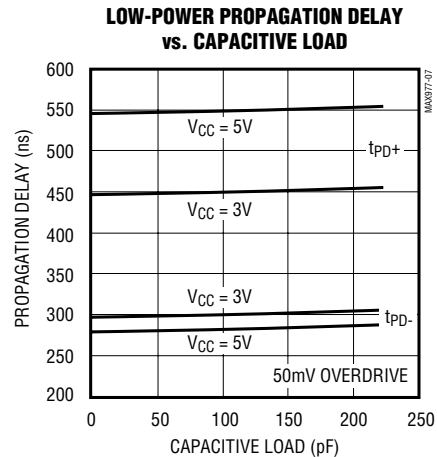
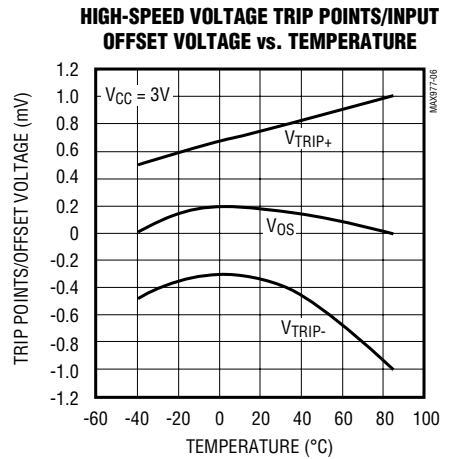
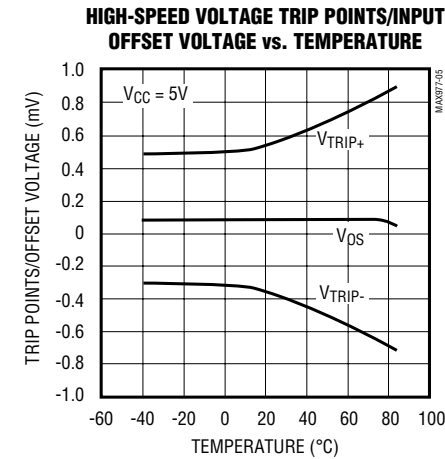
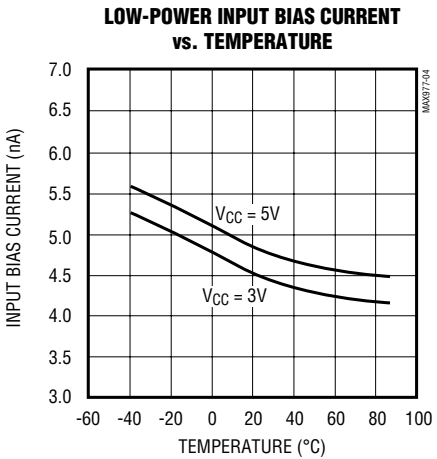
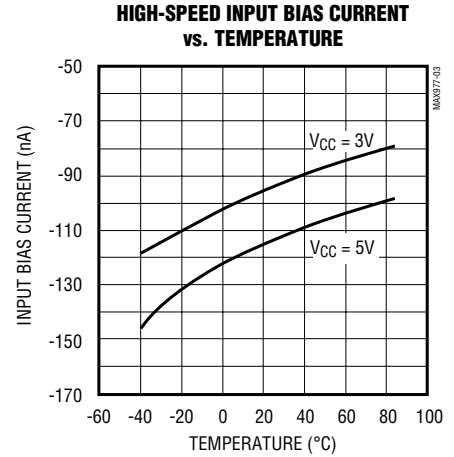
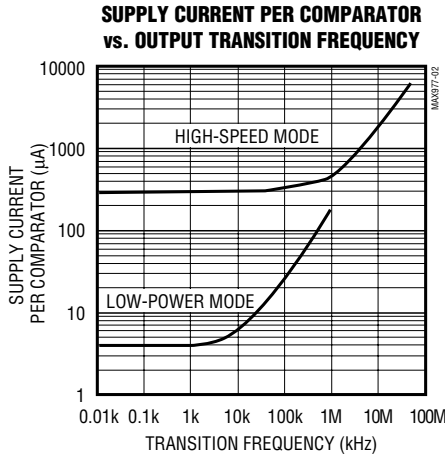
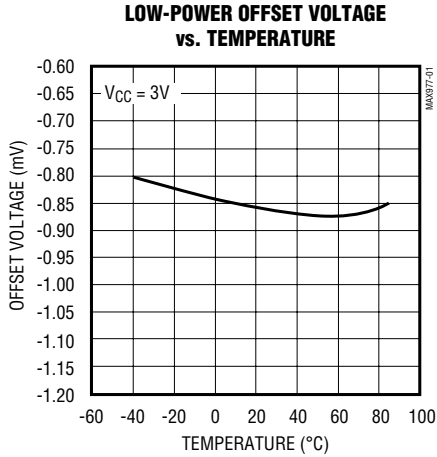

# Single/Dual, +3V/+5V Dual-Speed Comparators with Auto-Standby

## Typical Operating Characteristics (continued)

( $V_{CC} = 3.0V$ ,  $T_A = +25^\circ C$ , unless otherwise noted.)

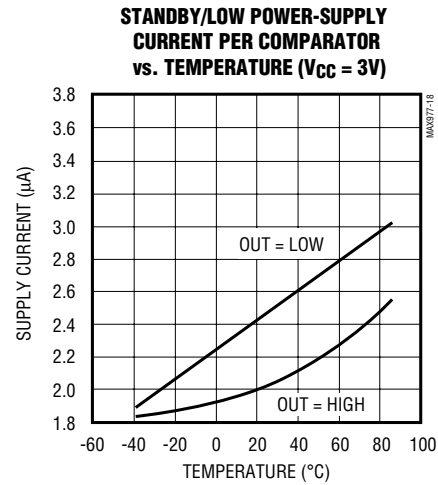
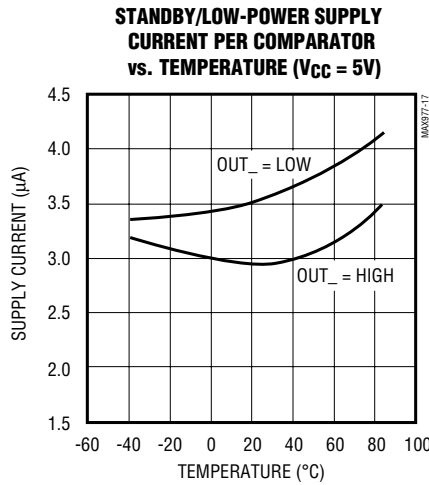
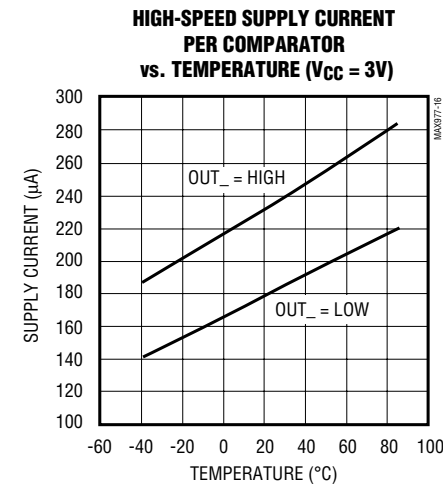
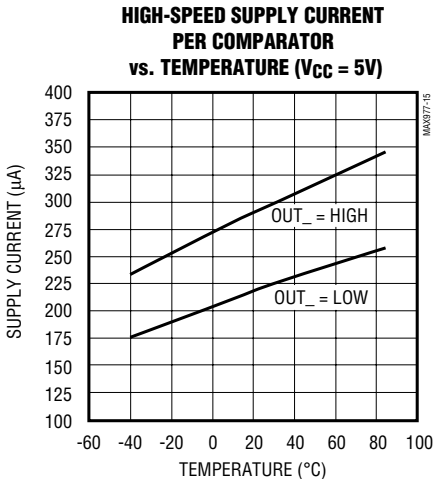
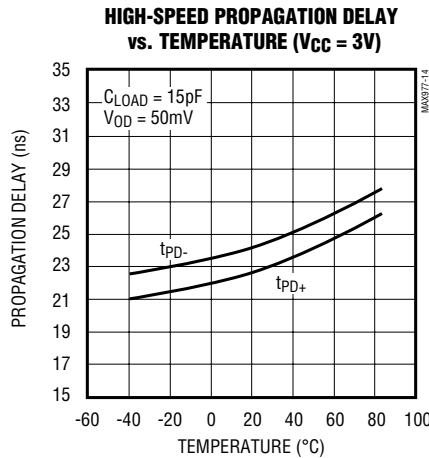
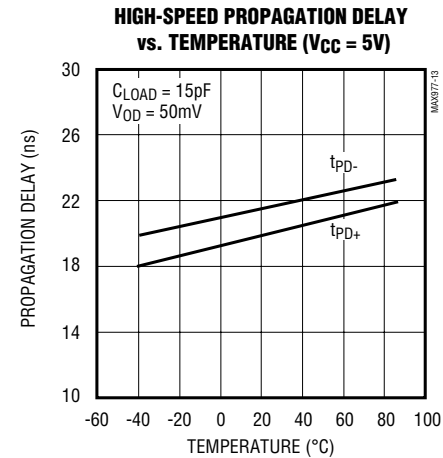
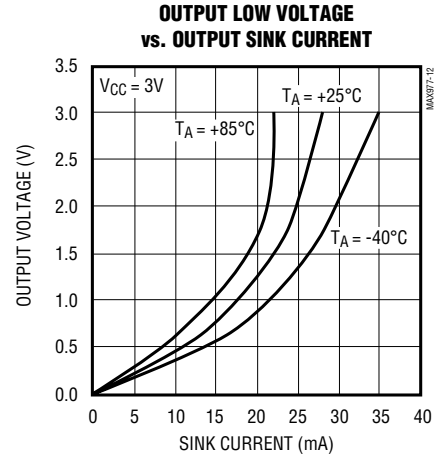
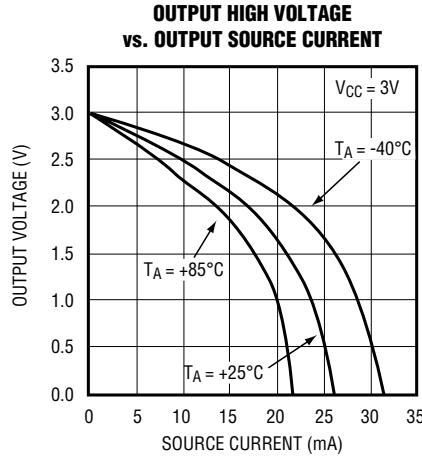
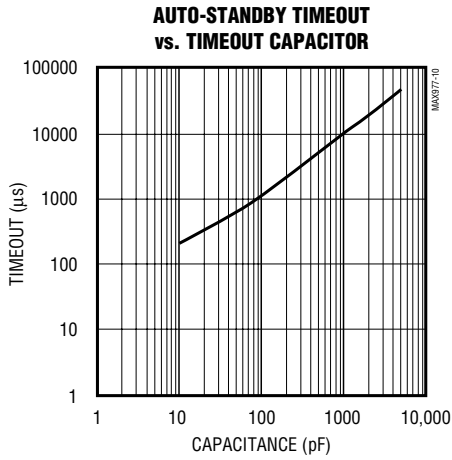



# Single/Dual, +3V/+5V Dual-Speed Comparators with Auto-Standby

## Typical Operating Characteristics (continued)

( $V_{CC} = 3.0V$ ,  $T_A = +25^\circ C$ , unless otherwise noted.)

MAX975/MAX977

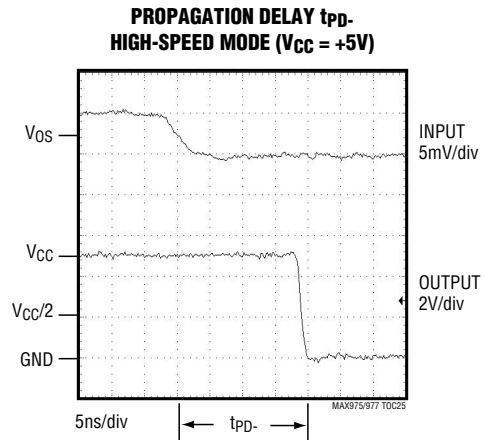
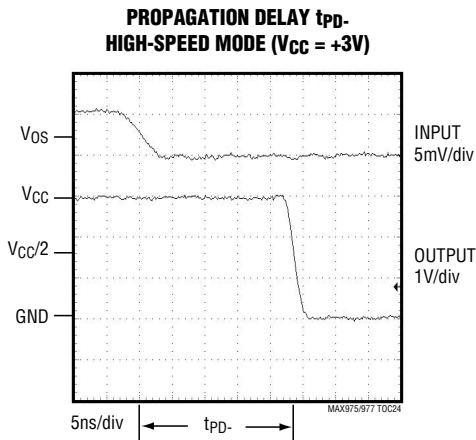
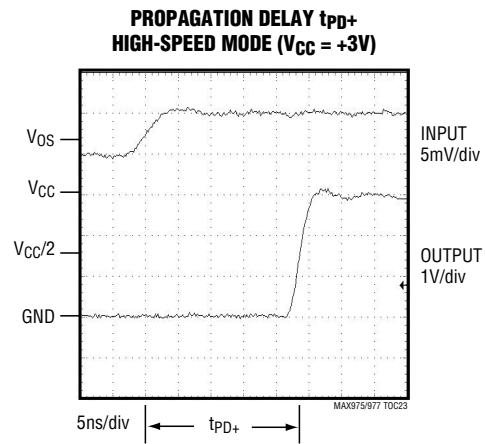
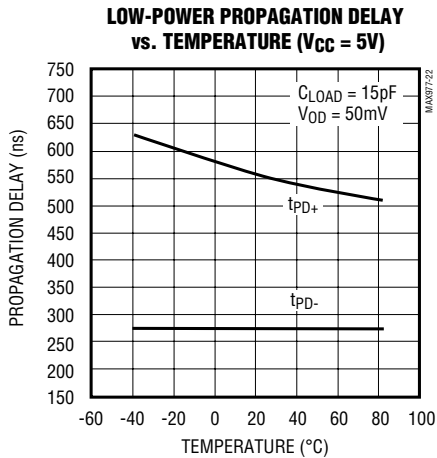
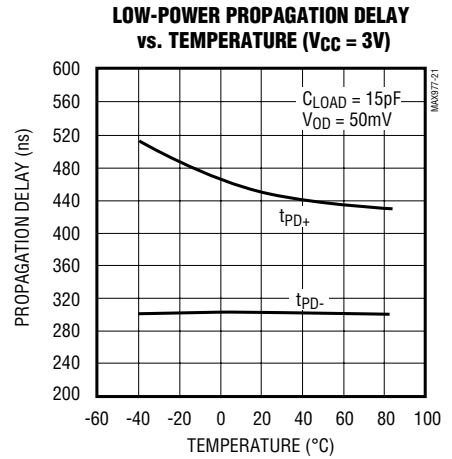
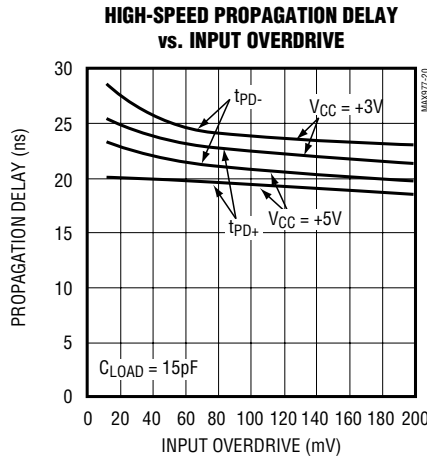
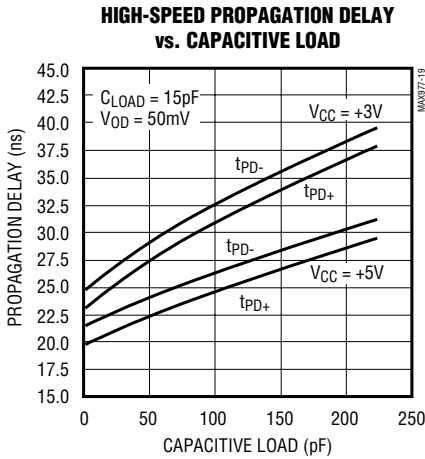

# Single/Dual, +3V/+5V Dual-Speed Comparators with Auto-Standby

## Typical Operating Characteristics (continued)

( $V_{CC} = 3.0V$ ,  $T_A = +25^\circ C$ , unless otherwise noted.)

MAX975/MAX977

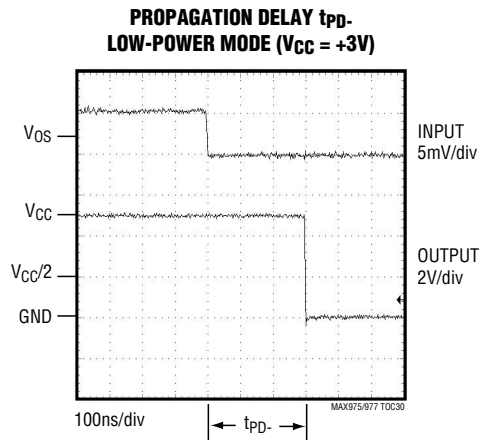
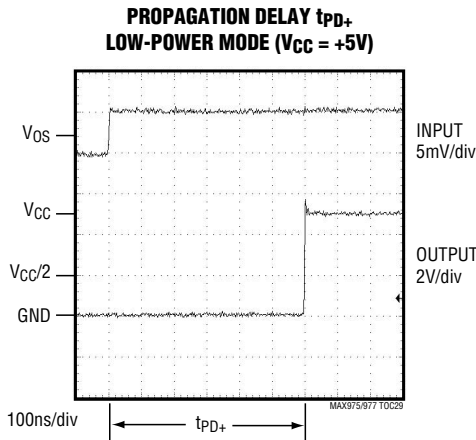
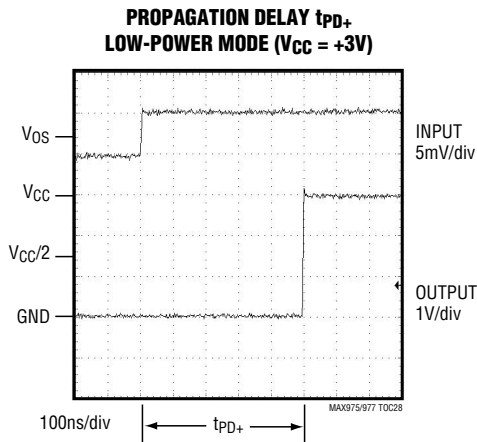
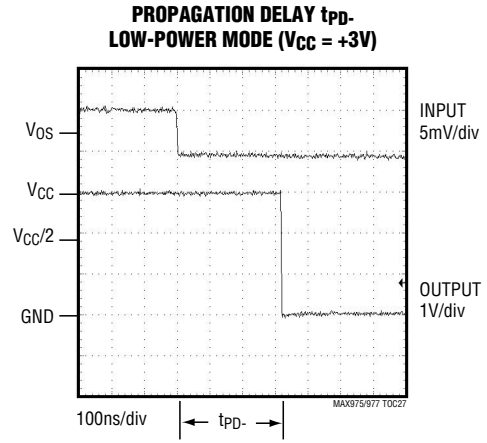
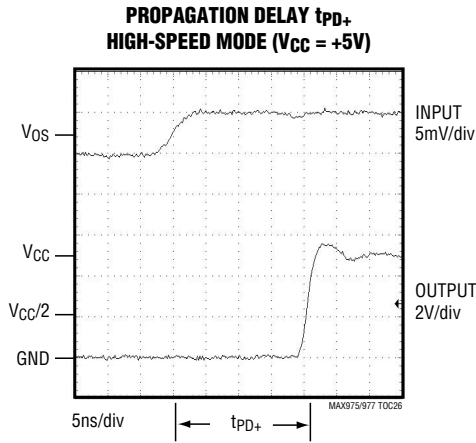

# Single/Dual, +3V/+5V Dual-Speed Comparators with Auto-Standby

MAX975/MAX977

## Typical Operating Characteristics (continued)

( $V_{CC} = 3.0V$ ,  $T_A = +25^{\circ}C$ , unless otherwise noted.)

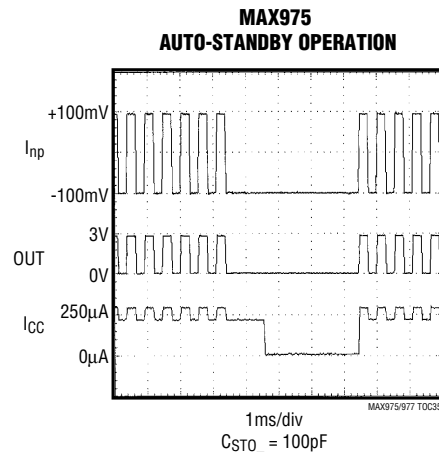
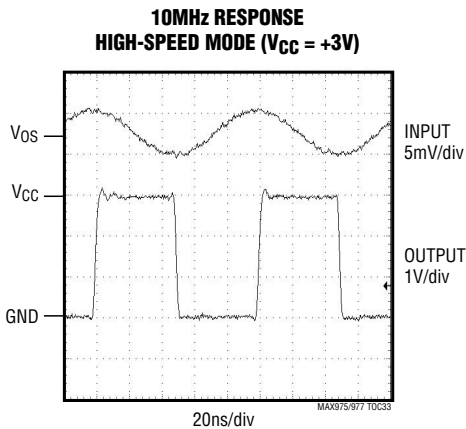
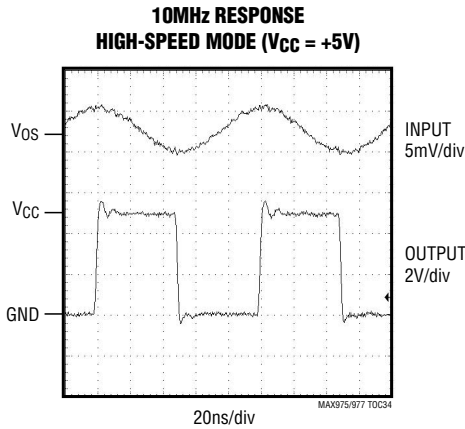
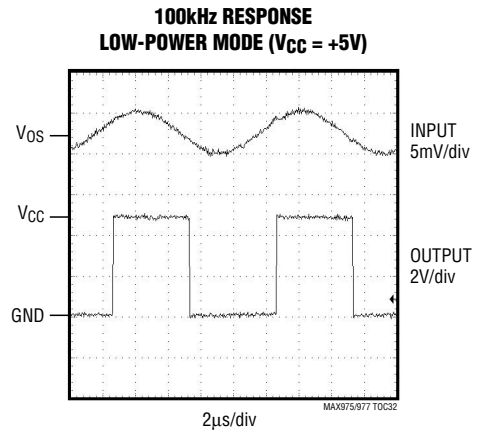
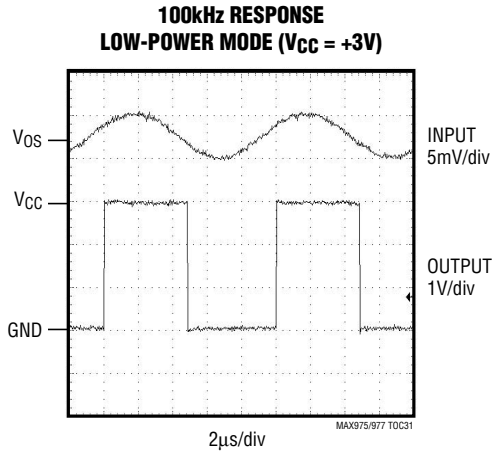

# Single/Dual, +3V/+5V Dual-Speed Comparators with Auto-Standby

## Pin Descriptions

MAX975/MAX977

### MAX975

PIN	NAME	FUNCTION
1	V <sub>CC</sub>	Positive Supply Voltage, +2.7V to +5.25V
2	IN+	Noninverting Comparator Input
3	IN-	Inverting Comparator Input
4	STAT	Mode Status Pin. Indicates the operating mode. STAT is high for auto-standby mode or low-power mode, and during the transition to high-speed mode. STAT = low indicates that the comparator is in high-speed mode. STAT can source 3mA to power additional circuitry.
5	STO	Set Timeout Input. Connect a capacitor from STO to GND to program the time the comparator may remain idle before entering standby mode. Connect STO to GND to disable the auto-standby feature. Calculate timeout with the following relationship: $t_{ASB} = 10 \times C \mu s$ , where C is in pF.
6	GND	Ground
7	OUT	Comparator Output
8	LP	Low Power Mode Input. Drive LP high for low-power mode. Drive LP low for high-speed mode (STO = GND) or for high-speed mode with auto-standby. Connect to GND if low-power mode will not be used. Connect to V <sub>CC</sub> if high-speed mode will not be used.

### MAX977

SO	QSOP	NAME	FUNCTION
1, 8	1, 9	STOA, STOB	Set Idle Timeout Input A/B. Connect a capacitor from STOA/STOB to GND to program the time in which comparator A/B may remain idle before entering standby mode. Connect STOA/STOB to GND to disable the auto-standby feature for comparator A/B. Calculate timeout with the following relationship: $t_{ASB} = 10 \times C \mu s$ , where C is in pF.
2, 9	2, 10	GNDA, GNDB	Ground for Comparator A/B
3, 10	3, 11	OUTA, OUTB	Output for Comparator A/B
4	4, 5	V <sub>CC</sub>	Positive Supply Voltage, +2.7V to +5.25V. For QSOP, connect pin 4 to pin 5.
5, 12	6, 14	INB+, INA+	Noninverting Input for Comparator B/A
6, 13	7, 15	INB-, INA-	Inverting Input for Comparator B/A
7, 14	8, 16	STATB, STATA	Mode Status Pin B/A. Indicates the operating mode of comparator B/A. STATB/STATA is high for auto-standby mode or for low-power mode, and during the transition to high-speed mode. STATB/STATA = low indicates that comparator B/A is in high-speed mode. STATB/STATA can source 3mA to power additional circuitry.
—	12	N.C.	No Connection. Not internally connected.
11	13	LP	Low Power Mode Input for both comparators. Drive LP high for low-power mode. Drive LP low for high-speed mode (STO_ = GND) or for high-speed mode with auto-standby. Connect to GND if low-power mode will not be used. Connect to V <sub>CC</sub> if high-speed mode will not be used.

# Single/Dual, +3V/+5V Dual-Speed Comparators with Auto-Standby

**Table 1. Programming**

INPUTS			MODE	STAT OUTPUT
LP	STO_	IDLE TIME		
L	$t_{ASB} = C_{STO} \times 10\mu s/pF$	$<t_{ASB}$	High speed (Auto-standby enabled)	L
L	$t_{ASB} = C_{STO} \times 10\mu s/pF$	$\geq t_{ASB}$	Auto-standby	H
↓ (falling edge)	L	X	High speed (Auto-standby mode disabled)	L
H	X	X	Low power	H

## Detailed Description

The MAX975/MAX977 single/dual comparators have three operating modes, and use a +2.7V to +5.25V single supply. The operating modes are as follows: high speed, high speed with auto-standby, and low power. Propagation delay is typically 28ns in high-speed mode, while typical supply current is 250 $\mu$ A. In low-power mode, propagation delay is typically 480ns and power consumption is only 3 $\mu$ A. The auto-standby feature switches into low-power standby for each comparator with unchanging outputs in high-speed mode. The timeout period, or the time that OUT\_ must be idle (unchanged state) for the MAX975/MAX977 to enter auto-standby, is adjustable by means of an external capacitor. All inputs and outputs can tolerate a continuous short-circuit fault condition to either rail. Internal hysteresis in high-speed mode ensures clean output switching, even with slow-moving input signals.

The MAX975 functional diagram shows two paralleled comparators, a timing circuit, a transition detector, and logic gates. The upper comparator is high speed, while the lower comparator is a slower low-power comparator. The dual MAX977 features independent timeout adjustment. The following sections discuss the details of operation.

### Hysteresis (High-Speed Mode Only)

Most high-speed comparators can oscillate in the linear operating region because of noise or undesired parasitic feedback. This tends to occur when the voltage on one input is equal to or very close to the voltage on the other input. The MAX975/MAX977 have internal hysteresis to counter parasitic effects and noise.

The hysteresis in a comparator creates two trip points: one for the rising input voltage and one for the falling

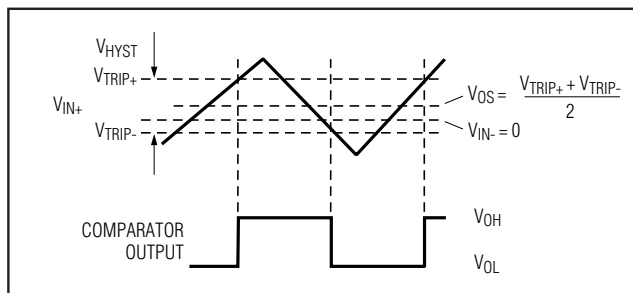

Figure 1. Input and Output Waveforms, Noninverting Input Varied

input voltage (Figure 1). The difference between the trip points is the hysteresis. When the comparators' input voltages are equal, the hysteresis effectively causes one comparator input voltage to move quickly past the other, taking the input out of the region where oscillation occurs.

Figure 1 illustrates the case where IN- has a fixed voltage applied and IN+ is varied. If the inputs were reversed, the figure would be the same, except with an inverted output.

### Auto-Standby Mode

The MAX975/MAX977's auto-standby function operates only in high-speed mode. The device enters auto-standby when OUT\_ remains unchanged for a preprogrammed timeout period. In auto-standby mode, the low-power comparator is enabled while the high-speed comparator is disabled and STAT\_ goes high. The logic state and sink/source capabilities of OUT\_ remain unchanged, but propagation delay increases to 480ns. In this mode, the timing circuitry is powered down, and the transition detector monitors the low-power comparator for a transition. When an output transition occurs (OUT\_ changes state), the timing circuitry is

# Single/Dual, +3V/+5V Dual-Speed Comparators with Auto-Standby

MAX975/MAX977

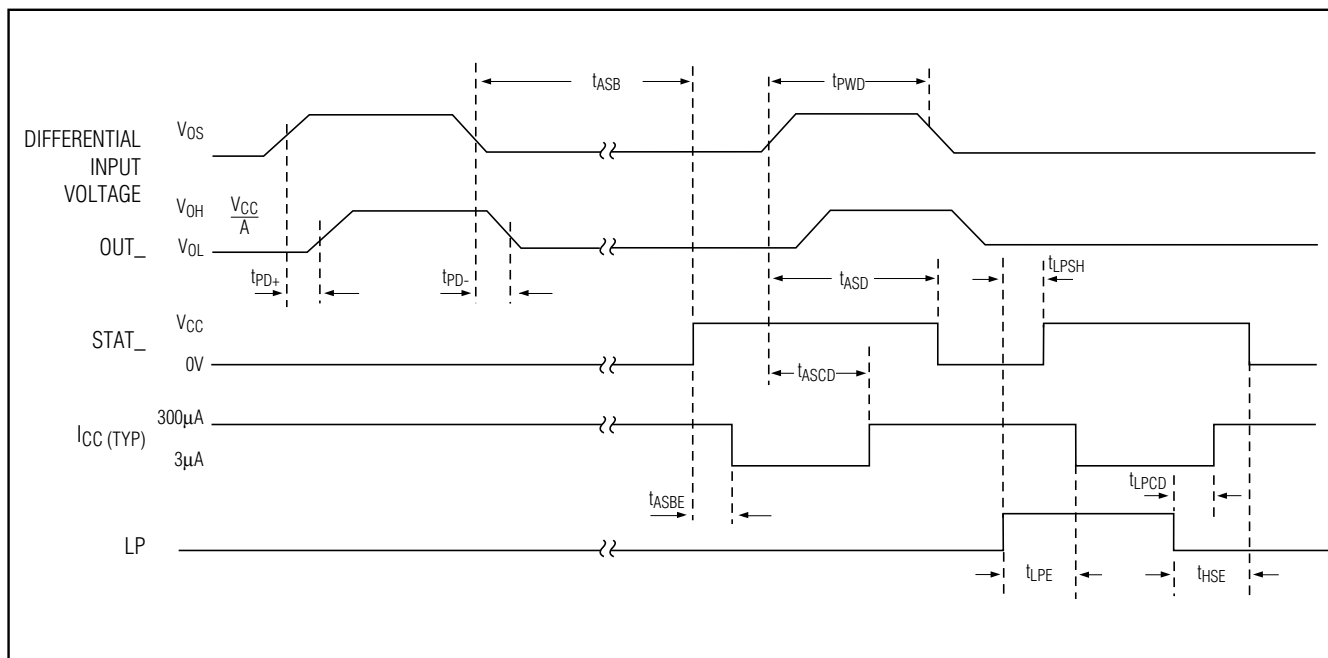

Figure 2. Timing Diagram

powered up, the high-speed comparator is enabled, the low-power comparator is disabled, and STAT goes high, placing the MAX975 back into high-speed mode (Figure 2).

Use an external capacitor,  $C_{STO}$ , to program the timeout period required for the comparator to enter auto-standby mode. Determine the capacitor required for a particular timeout period by the relationship  $t_{ASB} = 10 \times C_{\mu s}$ , where  $C$  is in pF. For example, connecting a  $0.1\mu F$  capacitor to  $STO_+$  results in a timeout period of 1sec. The propagation delay of  $OUT_+$  when exiting auto-standby mode is equivalent to the low-power-mode propagation delay. When  $STAT_+$  goes low, the low-power comparator is disabled and the high-speed comparator is ready for operation. To bring the comparator out of auto-standby mode without a transition occurring on  $OUT_+$ , toggle  $LP$  low-high-low. The  $LP$  pin is sensitive to noise. If fall times larger than  $10\mu s$  are expected, bypass  $LP$  with a  $0.1\mu F$  capacitor to GND. To disable auto-standby mode, drive  $STO_+$  low or connect it to ground. Note that driving  $STO_+$  low while in auto-standby mode will not bring the comparator out of auto-standby mode. Also, if driving  $STO_+$  with an open drain, leakage must be less than  $1nA$ . On power-up, the device is in high-speed mode unless  $LP$  is high. The MAX977 operates in the same manner as the MAX975.

### Low-Power Mode

Driving  $LP$  high switches the MAX975/MAX977 to low-power mode. In this mode, the supply current drops to a maximum of  $5\mu A$ , and propagation delay increases typically to  $480ns$ . The high-speed comparator is disabled and the low-power comparator is enabled for continuous operation. Return to high-speed mode by driving  $LP$  low. The  $LP$  pin is sensitive to noise. If fall times larger than  $10\mu s$  are expected, bypass  $LP$  with a  $0.1\mu F$  capacitor to GND. The logic state and sink/source capabilities of  $OUT_+$  remain unchanged in low-power mode.

### Input-Stage Circuitry

The MAX975/MAX977 input common-mode range is from  $-0.2V$  to  $(V_{CC} - 1.2V)$ . But the voltage range for each comparator input extends to both  $V_{CC}$  and GND rails. The output remains in the correct logic state while one or both of the inputs are within the common-mode range. If both input levels are out of the common-mode range, input-stage current saturation occurs and the output becomes unpredictable.

# Single/Dual, +3V/+5V Dual-Speed Comparators with Auto-Standby

## Applications Information

### Powering Circuitry with STAT

STAT's function is to indicate the comparator's operating mode. When STAT is low, the comparator is in high-speed mode and will meet the guaranteed propagation delay. When STAT is high, the comparator is in auto-standby mode, in low-power mode, or in transition to high-speed mode. An additional feature of this pin is that it can source 3mA of current. When STAT is high, additional circuitry can be powered. This circuitry can be automatically powered up or powered down, depending on the input signal or lack of input signal received by the MAX975/MAX977.

### STO\_ Considerations

The charge currents for the capacitor connected to STO\_ are on the order of 100nA. This necessitates caution in capacitor type selection and board layout. Capacitor leakage currents must be less than 1nA to prevent timing errors. Ceramic capacitors are available in values up to 1 $\mu$ F, and are an excellent choice for this application. If a larger capacitance value is needed, use parallel ceramic capacitors to get the required capacitance. Aluminum and tantalum electrolytic capacitors are not recommended due to their higher leakage currents.

Board layout can create timing errors due to parasitic effects. Make the STO\_ traces as short as possible to reduce capacitance and coupling effects. When driving STO\_ to disable auto-standby mode, use standard CMOS logic isolated with a low-leakage (<1nA) diode, such as National's FJT1100 (Figure 3). 15nA leakage typically results in 10% error.

The MAX977 has separate timing inputs (STOA and STOB). These pins must have separate capacitors. The timing circuits will not operate correctly if a single capacitor is used with STOA and STOB connected together.

The relationship between the timeout period and the STO\_ capacitor is  $t_{ASB} = 10 \times C_{STO\_} \mu s$ , where  $C_{STO\_}$  is in pF. This equation is for larger capacitance values, and does not take into account variations due to board capacitance and board leakage. If less than 1ms is desired, subtract the ~3pF STO\_ parasitic capacitance from the calculated value.

### Circuit Layout and Bypassing

The MAX975/MAX977's high gain bandwidth requires design precautions to realize the comparator's full high-speed capability. The following precautions are recommended:

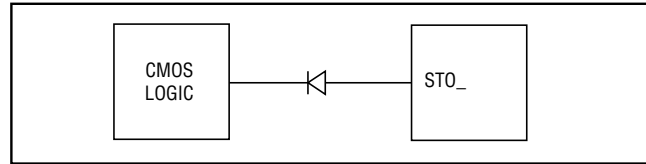

Figure 3. Driving STO\_ with CMOS Logic

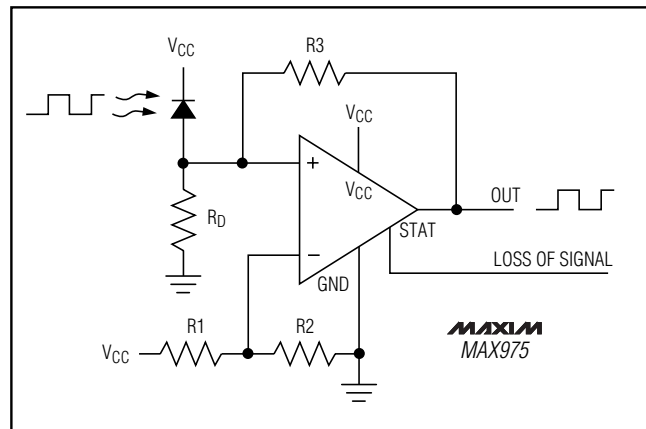

Figure 4. IR Receiver

- 1) Use a printed circuit board with an unbroken, low-inductance ground plane.
- 2) Place a decoupling capacitor (a 0.1 $\mu$ F ceramic capacitor is a good choice) as close to VCC as possible.
- 3) Keep lead lengths short on the inputs and outputs, to avoid unwanted parasitic feedback around the comparators.
- 4) Solder the devices directly to the printed circuit board instead of using a socket.
- 5) Minimize input impedance.
- 6) For slowly varying inputs, use a small capacitor (~1000pF) across the inputs to improve stability.

### IR Receiver

Figure 4 shows an application using the MAX975 as an infrared receiver. The infrared photodiode creates a current relative to the amount of infrared light present. This current creates a voltage across  $R_D$ . When this voltage level crosses the voltage applied by the voltage divider to the inverting input, the output transitions. If the photodiode is not receiving enough signal to cause transitions on the MAX975's output, STAT is used as a loss-of-signal indicator.  $R_3$  adds additional hysteresis for noise immunity.

MAX975/MAX977

# Single/Dual, +3V/+5V Dual-Speed Comparators with Auto-Standby

MAX975/MAX977

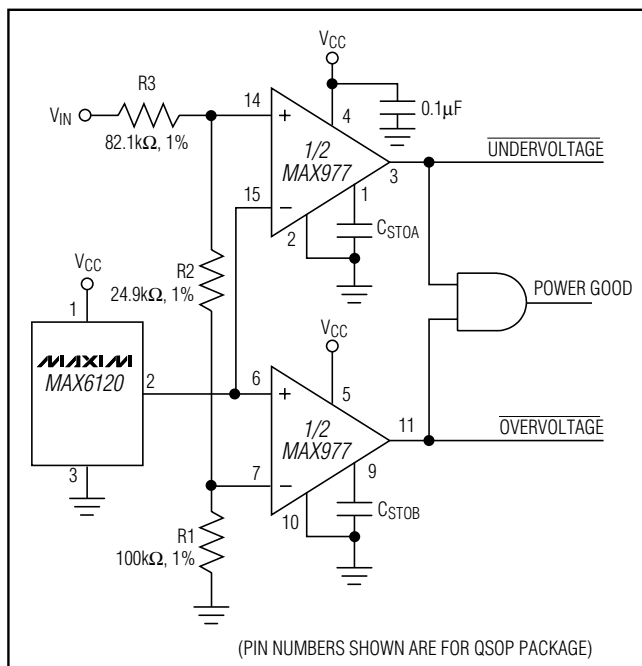

Figure 5. Window Comparator

## Window Comparator

The MAX977 is ideal for making a window detector (undervoltage/overvoltage detector). The schematic shown in Figure 5 uses a MAX6120 reference and component values selected for a 2.0V undervoltage threshold and a 2.5V overvoltage threshold. Choose different thresholds by changing the values of R1, R2, and R3. OUTA provides an active-low undervoltage indication, and OUTB gives an active-low overvoltage indication. ANDing the two outputs provides an active-high, power-good signal. The design procedure is as follows:

- 1) Select R1. The leakage current into INB- is normally 100nA, so the current through R1 should exceed 10μA for the thresholds to be accurate. R1 values in the 50kΩ to 100kΩ range are typical.
- 2) Choose the overvoltage threshold ( $V_{OTH}$ ) when  $V_{IN}$  is rising, and calculate R2 and R3 with the following formula:  

$$R2 + R3 = R1 \times [V_{OTH} / (V_{REF} + V_H) - 1]$$
 where  $V_H = 1/2V_{HYST}$ .
- 3) Choose the undervoltage threshold ( $V_{UTH}$ ) when  $V_{IN}$  is falling, and calculate R2 with the following formula:  

$$R2 = (R1 + R2 + R3) \times [(V_{REF} - V_H) / V_{UTH}] - R1$$
 where  $V_H = 1/2V_{HYST}$ .

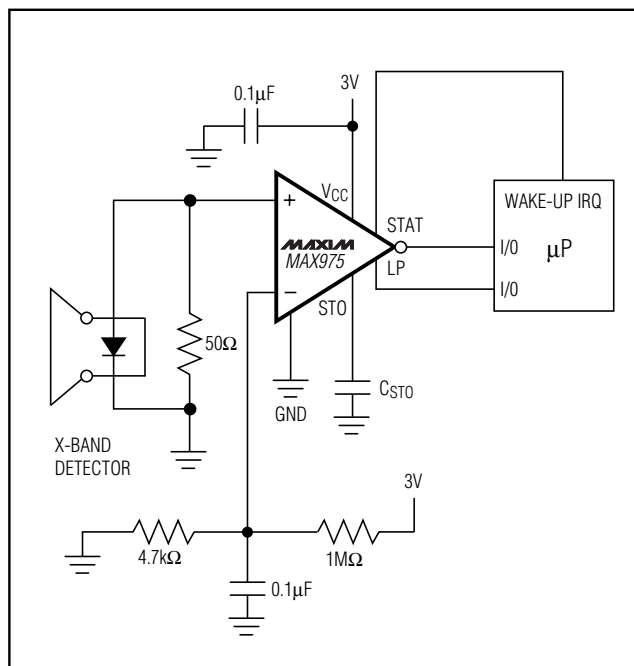

Figure 6. Toll-Tag Reader

- 4) Calculate R3 with the following formula:

$$R3 = (R2 + R3) - R2$$

- 5) Verify the resistor values. The equations are as follows:

$$V_{OTH} = (V_{REF} + V_H) \times (R1 + R2 + R3) / R1$$

$$V_{UTH} = (V_{REF} - V_H) \times (R1 + R2 + R3) / (R1 + R2)$$

## Toll-Tag Circuit

The circuit shown in Figure 6 uses a MAX975 in a very low standby-power AM demodulator circuit that wakes up a toll tag (part of an automated roadway toll-collection system). This application requires very long standby times with brief and infrequent interrogations. In the awake state, it is capable of demodulating the typical 600kHz AM carrier riding on the 2.4GHz RF signal. In this state, the comparator draws its 250μA high-speed current. After communications have ceased, or when instructed by the microcontroller, the comparator returns to its low-power state. The comparator draws only 3μA in this state, while monitoring for RF activity. Typically, this application requires two comparators and a discrete power-management and signal-switchover circuit. The MAX975 circuit is smaller, simpler, less costly, and saves design time.



# Single/Dual, +3V/+5V Dual-Speed Comparators with Auto-Standby

## Pin Configurations

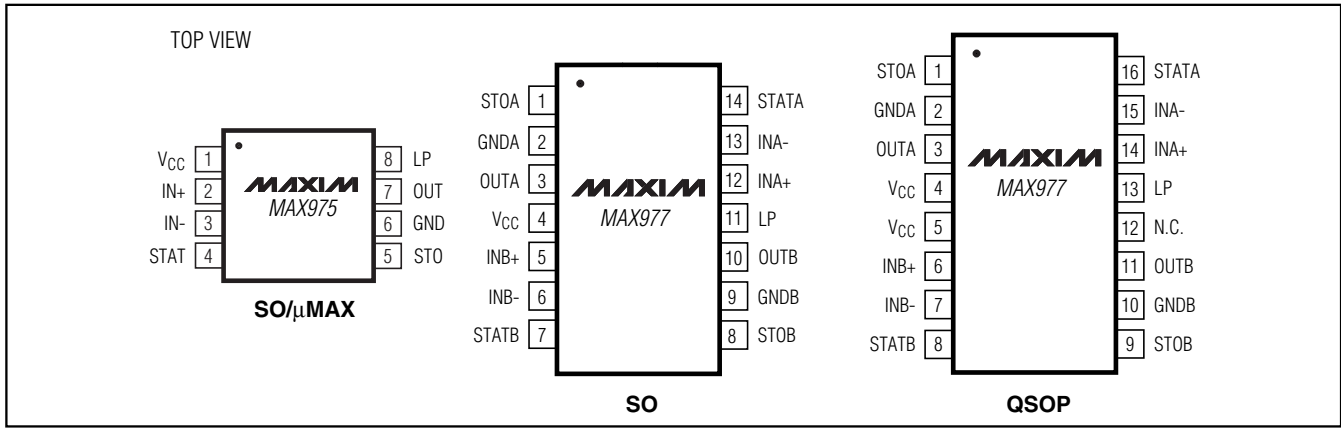

MAX975/MAX977

## Chip Information

TRANSISTOR COUNT: 522 (MAX975)  
1044 (MAX977)

# Single/Dual, +3V/+5V Dual-Speed Comparators with Auto-Standby

MAX975/MAX977

## Package Information

(The package drawing(s) in this data sheet may not reflect the most current specifications. For the latest package outline information go to [www.maxim-ic.com/packages](http://www.maxim-ic.com/packages).)

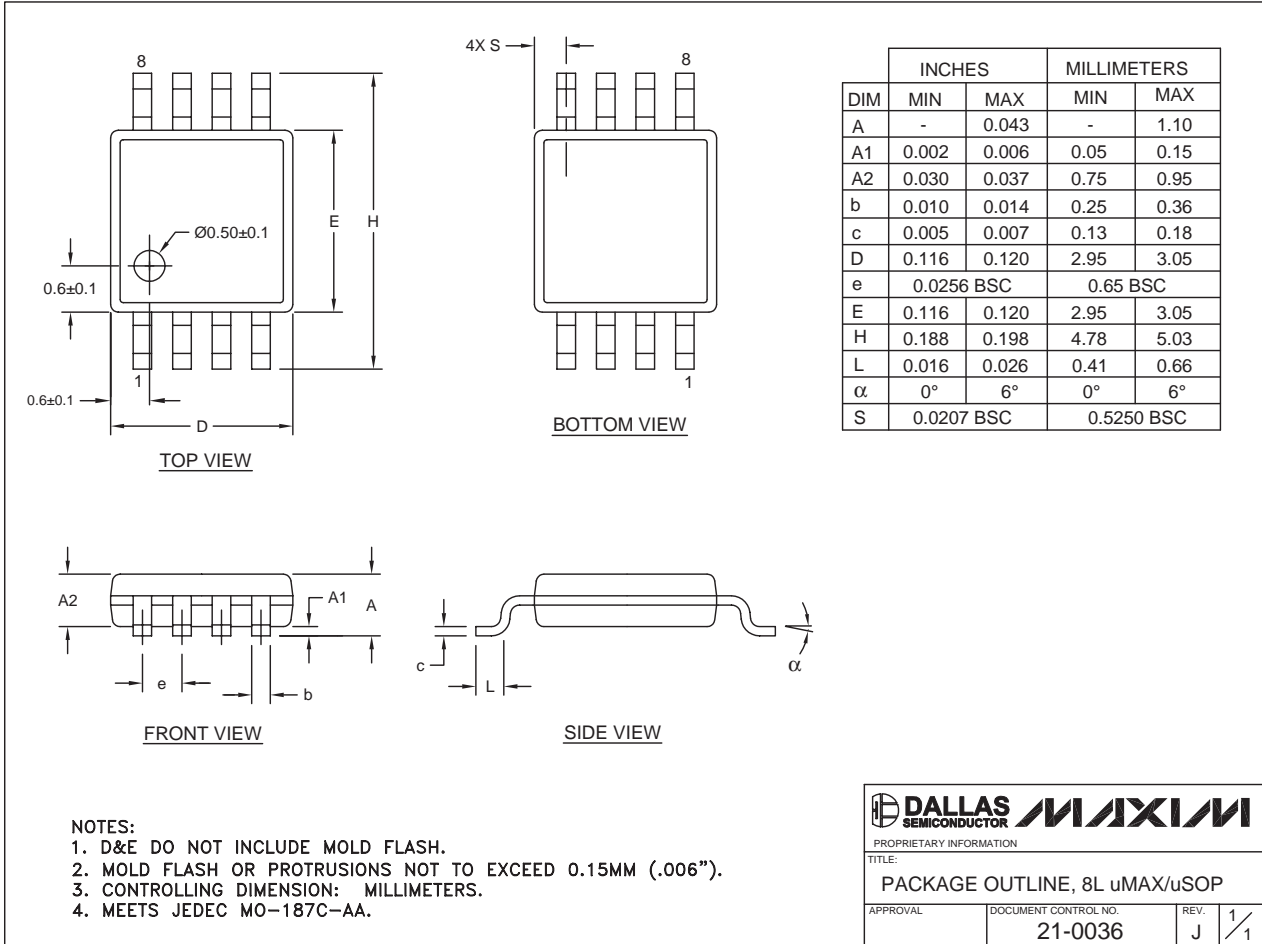

8L uMAX uSOP

# Single/Dual, +3V/+5V Dual-Speed Comparators with Auto-Standby

## Package Information (continued)

(The package drawing(s) in this data sheet may not reflect the most current specifications. For the latest package outline information go to [www.maxim-ic.com/packages](http://www.maxim-ic.com/packages).)

MAX975/MAX977

DIM	INCHES		MILLIMETERS	
	MIN	MAX	MIN	MAX
A	.053	.069	1.35	1.75
A1	.004	.010	.102	.254
A2	.049	.065	1.245	1.651
B	.008	.012	0.20	0.30
C	.0075	.0098	0.191	0.249
D	SEE VARIATIONS			
E	.150	.157	3.81	3.99
e	.025 BSC		0.635 BSC	
H	.230	.244	5.84	6.20
h	.010	.016	0.25	0.41
L	.016	.035	0.41	0.89
N	SEE VARIATIONS			
α	0°	8°	0°	8°

VARIATIONS:					
DIM	INCHES		MILLIMETERS		N
	MIN.	MAX.	MIN.	MAX.	
D	.189	.196	4.80	4.98	16 AB
S	.0020	.0070	0.05	0.18	
D	.337	.344	8.56	8.74	20 AD
S	.0500	.0550	1.270	1.397	
D	.337	.344	8.56	8.74	24 AE
S	.0250	.0300	0.635	0.762	
D	.386	.393	9.80	9.98	28 AF
S	.0250	.0300	0.635	0.762	

NOTES:

- 1). D & E DO NOT INCLUDE MOLD FLASH OR PROTRUSIONS.
- 2). MOLD FLASH OR PROTRUSIONS NOT TO EXCEED .006" PER SIDE.
- 3). CONTROLLING DIMENSIONS: INCHES.
- 4). MEETS JEDEC MQ137.

**DALLAS SEMICONDUCTOR** **MAXIM**

PROPRIETARY INFORMATION

TITLE: PACKAGE OUTLINE, QSOP .150", .025" LEAD PITCH

APPROVAL	DOCUMENT CONTROL NO. 21-0055	REV. F	1/1
----------	---------------------------------	-----------	-----

## Revision History

Pages changed at Rev 2: 1, 2, 6, 7, 10, 14-16

Maxim cannot assume responsibility for use of any circuitry other than circuitry entirely embodied in a Maxim product. No circuit patent licenses are implied. Maxim reserves the right to change the circuitry and specifications without notice at any time.

Maxim Integrated Products, 120 San Gabriel Drive, Sunnyvale, CA 94086 408-737-7600 17

## OUR CERTIFICATE

DiGi provide top-quality products and perfect service for customer worldwide through standardization, technological innovation and continuous improvement. DiGi through third-party certification, we stricly control the quality of products and services. Welcome your RFQ to

Email: [Info@DiGi-Electronics.com](mailto:Info@DiGi-Electronics.com)



Tel: +00 852-30501935

RFQ Email: [Info@DiGi-Electronics.com](mailto:Info@DiGi-Electronics.com)

DiGi is a global authorized distributor of electronic components.