

REF02HPZ Datasheet

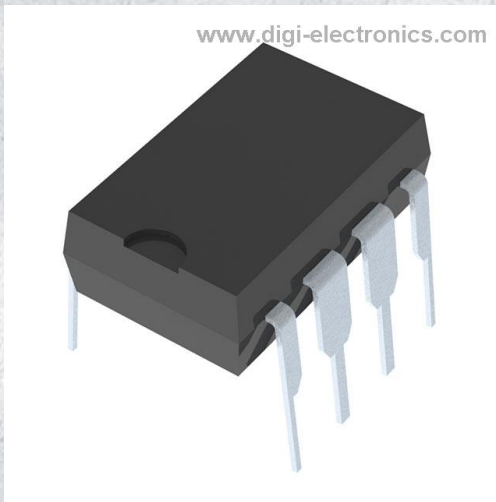

<https://www.DiGi-Electronics.com>

DiGi Electronics Part Number	REF02HPZ-DG
Manufacturer	Analog Devices Inc.
Manufacturer Product Number	REF02HPZ
Description	IC VREF SERIES 0.5% 8DIP
Detailed Description	Series Voltage Reference IC Fixed 5V V \pm 0.5% 10 mA 8-PDIP

This model REF02HPZ is available at DiGi Electronics.

DiGi Electronics offers a global database of semiconductor and electronic component datasheets.

We welcome your inquiries regarding pricing, lead time, or other product-related questions.

 [Request a Quote](#)

 [Datasheet Search](#)



Tel: +00 852-30501935

RFQ Email: Info@DiGi-Electronics.com

DiGi is a global authorized distributor of electronic components.

Purchase and inquiry

Manufacturer Product Number:

REF02HPZ

Series:

REF02

Reference Type:

Series

Voltage - Output (Min/Fixed):

5V

Tolerance:

±0.5%

Noise - 0.1Hz to 10Hz:

15µVp-p

Voltage - Input:

8V ~ 36V

Operating Temperature:

-40°C ~ 85°C (TA)

Package / Case:

8-DIP (0.300", 7.62mm)

Base Product Number:

REF02

Manufacturer:

Analog Devices Inc.

Product Status:

Active

Output Type:

Fixed

Current - Output:

10 mA

Temperature Coefficient:

25ppm/°C

Noise - 10Hz to 10kHz:

-

Current - Supply:

1.4mA

Mounting Type:

Through Hole

Supplier Device Package:

8-PDIP

Environmental & Export classification

RoHS Status:

ROHS3 Compliant

REACH Status:

REACH Unaffected

HTSUS:

8542.39.0001

Moisture Sensitivity Level (MSL):

1 (Unlimited)

ECCN:

EAR99



Precision 2.5 V, 5.0 V, and 10.0 V Voltage References

Data Sheet

REF01/REF02/REF03

FEATURES

High output accuracy

REF01: 10.0 V, $\pm 0.3\%$ maximum

REF02: 5.0 V, $\pm 0.3\%$ maximum

REF03: 2.5 V, $\pm 0.6\%$ maximum

Adjustable output: $\pm 3\%$ minimum

Excellent temperature stability

REF01: 8.5 ppm/ $^{\circ}\text{C}$ maximum

REF02: 8.5 ppm/ $^{\circ}\text{C}$ maximum

REF03: 50 ppm/ $^{\circ}\text{C}$ maximum

Low noise

REF01: 30 μV p-p typical

REF02: 15 μV p-p typical

REF03: 6 μV p-p typical

High supply voltage range: up to 36 V maximum

Low supply current: 1.4 mA maximum

High load-driving capability: 10 mA maximum

Temperature output function

APPLICATIONS

Precision data systems

High resolution converters

Industrial process control systems

Precision instruments

Military and aerospace applications

GENERAL DESCRIPTION

The REF01/REF02/REF03 series of precision voltage references provide a stable 10.0 V, 5.0 V, or 2.5 V output with minimal change in response to variations in supply voltage, ambient temperature or load conditions. The devices are available in 8-lead SOIC, PDIP, CERDIP, and TO-99 packages, as well as 20-terminal LCC packages (883 only), furthering the usability of the devices in both standard and high stress applications.

With an external buffer and a simple resistor network, the TEMP terminal can be used for temperature sensing and approximation. A TRIM terminal is also provided on the device for fine adjustment of the output voltage.

The small footprint, wide supply range, and application versatility make the REF01/REF02/REF03 series of references ideal for general-purpose and space-constrained applications.

Newer designs should use the ADR01/ADR02/ADR03/ADR06 series of references, which offer higher accuracy and temperature

PIN CONFIGURATIONS

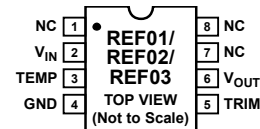

NC = NO CONNECT. DO NOT CONNECT ANYTHING ON THESE PINS. SOME OF THEM ARE RESERVED FOR FACTORY TESTING PURPOSES.

Figure 1. 8-Lead PDIP (P-Suffix),
8-Lead CERDIP (Z-Suffix),
8-Lead SOIC (S-Suffix)

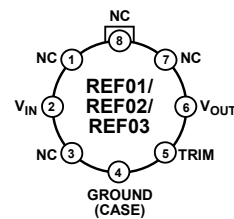

NC = NO CONNECT. DO NOT CONNECT ANYTHING ON THESE PINS. SOME OF THEM ARE RESERVED FOR FACTORY TESTING PURPOSES.

Figure 2. 8-Lead TO-99 (J-Suffix)

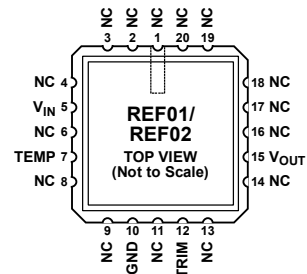

NC = NO CONNECT. DO NOT CONNECT ANYTHING ON THESE PINS. SOME OF THEM ARE RESERVED FOR FACTORY TESTING PURPOSES.

Figure 3. 20-Terminal LCC (RC-Suffix;
883 Devices Only)

stability over a wider operating temperature range, while maintaining full pin-for-pin compatibility with the REF01/REF02/REF03 series. This data sheet applies to commercial-grade products only. Contact sales or visit analog.com for military-grade (883) data sheets.

Table 1. Selection Guide

Device Number	Output Voltage	Input Voltage Range
REF01	10.0 V	12 V to 36 V
REF02	5.0 V	7.0 V to 36 V
REF03	2.5 V	4.5 V to 36 V

Rev. M

[Document Feedback](#)

Information furnished by Analog Devices is believed to be accurate and reliable. However, no responsibility is assumed by Analog Devices for its use, nor for any infringements of patents or other rights of third parties that may result from its use. Specifications subject to change without notice. No license is granted by implication or otherwise under any patent or patent rights of Analog Devices. Trademarks and registered trademarks are the property of their respective owners.

One Technology Way, P.O. Box 9106, Norwood, MA 02062-9106, U.S.A.
Tel: 781.329.4700 ©2009–2016 Analog Devices, Inc. All rights reserved.
Technical Support www.analog.com

TABLE OF CONTENTS

Features	1	Output Adjustment	14
Applications.....	1	Temperature Monitoring.....	15
General Description	1	Long-Term Stability	15
Pin Configurations	1	Burn-In	15
Revision History	2	Power Dissipation.....	15
Specifications.....	3	Applications Information	16
REF01 Specifications.....	3	Basic Reference Application.....	16
REF02 Specifications.....	4	Low Cost Current Source.....	16
REF03 Specifications.....	5	Precision Current Source with Adjustable Output	16
Absolute Maximum Ratings.....	6	Precision Boosted Output Regulator	16
Thermal Resistance	6	Bipolar Voltage Reference	17
ESD Caution.....	6	Adjustable Reference With Positive and Negative Swing	17
Pin Configurations and Function Descriptions	7	Outline Dimensions	18
Typical Performance Characteristics	8	REF01 Ordering Guide.....	20
Terminology	13	REF02 Ordering Guide.....	20
Theory of Operation	14	REF03 Ordering Guide.....	20
Input and Output Capacitors.....	14		

REVISION HISTORY

9/2016—Rev. L to Rev. M

Changes to Figure 43	17
Changes to Ordering Guide	20

10/2015—Rev. K to Rev. L

Changed REF0x to REF01/REF02/REF03.....	Throughout
Changes to Layout	1
Changes to General Description Section	1
Updated Outline Dimensions	18
Changes to Ordering Guide	20

10/2010—Rev. J to Rev. K

Deleted Negative References Section and Figure 39; Renumbered Sequentially	16
---	----

10/2009—Rev. J: Initial Version

Updated Format.....	Universal
Combined REF01, REF02, and REF03 Data Sheets.....	Universal
Changes to Absolute Maximum Input Voltage	6

SPECIFICATIONS

REF01 SPECIFICATIONS

$V_{IN} = 15\text{ V}$, $T_A = 25^\circ\text{C}$, $I_{LOAD} = 0\text{ mA}$, all grades, unless otherwise noted.

Parameter	Symbol	Conditions	Min	Typ	Max	Unit
OUTPUT VOLTAGE	V_O	A and E grades	9.97	10.00	10.03	V
		H grade	9.95	10.00	10.05	V
		C grade	9.90	10.00	10.10	V
OUTPUT ADJUSTMENT RANGE ¹	ΔV_{TRIM}	A, E and H grades, POT = 10 k Ω	± 3.0	± 3.3		%
		C grade, POT = 10 k Ω	± 2.7	± 3.0		%
INITIAL ACCURACY	V_{OERR}	A and E grades			± 30	mV
					± 0.3	%
		H grade			± 50	mV
					± 0.5	%
		C grade			± 100	mV
				± 1.0	%	
TEMPERATURE COEFFICIENT	TCV_O	A and E grades, $-55^\circ\text{C} \leq T_A \leq +125^\circ\text{C}$		3.0	8.5	ppm/ $^\circ\text{C}$
		H grade, $0^\circ\text{C} \leq T_A \leq +70^\circ\text{C}$		10	25	ppm/ $^\circ\text{C}$
		C grade, $0^\circ\text{C} \leq T_A \leq +70^\circ\text{C}$ (-J and -Z packages)		20	65	ppm/ $^\circ\text{C}$
		C grade, $-40 \leq T_A \leq +85^\circ\text{C}$ (-P and -S packages)		20	65	ppm/ $^\circ\text{C}$
LINE REGULATION ²	$\Delta V_O/\Delta V_{IN}$	A, E and H grades, $V_{IN} = 13\text{ V to }33\text{ V}$		60	100	ppm/V
		A, E and H grades, $V_{IN} = 13\text{ V to }33\text{ V}$, $0^\circ\text{C} \leq T_A \leq +70^\circ\text{C}$		70	120	ppm/V
		A, E and H grades, $V_{IN} = 13\text{ V to }33\text{ V}$, $-55^\circ\text{C} \leq T_A \leq +125^\circ\text{C}$		90	150	ppm/V
		C grade, $V_{IN} = 13\text{ V to }33\text{ V}$		90	150	ppm/V
		C grade, $V_{IN} = 13\text{ V to }30\text{ V}$, $0^\circ\text{C} \leq T_A \leq +70^\circ\text{C}$ (-J and -Z packages)		110	180	ppm/V
		C grade, $V_{IN} = 13\text{ V to }30\text{ V}$, $-40^\circ\text{C} \leq T_A \leq +85^\circ\text{C}$ (-P and -S packages)		110	180	ppm/V
LOAD REGULATION ²	$\Delta V_O/\Delta I_{LOAD}$	A and E grades, $I_{LOAD} = 0\text{ mA to }10\text{ mA}$		50	80	ppm/mA
		A and E grades, $I_{LOAD} = 0\text{ mA to }8\text{ mA}$, $0^\circ\text{C} \leq T_A \leq +70^\circ\text{C}$		60	100	ppm/mA
		A and E grades, $I_{LOAD} = 0\text{ mA to }8\text{ mA}$, $-55^\circ\text{C} \leq T_A \leq +125^\circ\text{C}$		90	150	ppm/mA
		H grade, $I_{LOAD} = 0\text{ mA to }10\text{ mA}$		60	100	ppm/mA
		H grade, $I_{LOAD} = 0\text{ mA to }8\text{ mA}$, $0^\circ\text{C} \leq T_A \leq +70^\circ\text{C}$		70	120	ppm/mA
		H grade, $I_{LOAD} = 0\text{ mA to }8\text{ mA}$, $-50^\circ\text{C} \leq T_A \leq +125^\circ\text{C}$		90	150	ppm/mA
		C grade, $I_{LOAD} = 0\text{ mA to }8\text{ mA}$		60	150	ppm/mA
		C grade, $I_{LOAD} = 0\text{ mA to }5\text{ mA}$, $0^\circ\text{C} \leq T_A \leq +70^\circ\text{C}$ (-J and -Z packages)		80	180	ppm/mA
		C grade, $I_{LOAD} = 0\text{ mA to }5\text{ mA}$, $-40^\circ\text{C} \leq T_A \leq +85^\circ\text{C}$ (-P and -S packages)		80	180	ppm/mA
		DROPOUT VOLTAGE	V_{DO}			2
QUIESCENT CURRENT	I_{IN}	A, E, and H grades		1.0	1.4	mA
		C grade		1.0	1.6	mA
LOAD CURRENT	I_{LOAD}	A, E, and H grades C grade			10	mA
					8	mA
					-0.3	mA
SHORT CIRCUIT TO GND	I_{SC}	$V_O = 0\text{ V}$		30		mA
VOLTAGE NOISE	$e_{N\text{ p-p}}$	0.1 Hz to 10.0 Hz (-S, -Z and -P packages)		30		$\mu\text{V p-p}$
		0.1 Hz to 10.0 Hz (-J package)		35		$\mu\text{V p-p}$
LONG-TERM STABILITY ³	ΔV_O	After 1000 hours of operation		50		ppm
TURN-ON SETTLING TIME	t_R	Output settling to within $\pm 0.1\%$ of final value		5		μs
TEMPERATURE SENSOR ⁴	V_{TEMP} TCV_{TEMP}	Voltage Output at TEMP Pin Temperature Sensitivity		580		mV
				1.96		mV/ $^\circ\text{C}$

¹ Refer to the Output Adjustment section.

² Specification includes the effects of self-heating.

³ Long-term stability is noncumulative; the drift in subsequent 1000-hour periods is significantly lower than in the first 1000-hour periods. Refer to the [Application Note AN-713](#).

⁴ Refer to the Temperature Monitoring section.

REF01/REF02/REF03

Data Sheet

REF02 SPECIFICATIONS

$V_{IN} = 15\text{ V}$, $T_A = 25^\circ\text{C}$, $I_{LOAD} = 0\text{ mA}$, all grades, unless otherwise noted. Nongraded refers to REF02Z.

Parameter	Symbol	Conditions	Min	Typ	Max	Unit
OUTPUT VOLTAGE	V_O	A and E grades	4.985	5.000	5.015	V
		H grade and nongraded	4.975	5.000	5.025	V
		C grade	4.950	5.000	5.050	V
OUTPUT ADJUSTMENT RANGE ¹	ΔV_{TRIM}	A, E, H grades and nongraded, POT = 10 k Ω	± 3.0	± 6.0		%
		C grade, POT = 10 k Ω	± 2.7	± 6.0		%
INITIAL ACCURACY	V_{OERR}	A and E grades			± 15	mV
					± 0.3	%
		H grade and nongraded			± 25	mV
					± 0.5	%
		C grade			± 50	mV
					± 1	%
TEMPERATURE COEFFICIENT	TCV_O	A grade and non-graded, $-55^\circ\text{C} \leq T_A \leq +125^\circ\text{C}$		3	8.5	ppm/ $^\circ\text{C}$
		E and H grades, $0^\circ\text{C} \leq T_A \leq +70^\circ\text{C}$		10	25	ppm/ $^\circ\text{C}$
		C grade, $0^\circ\text{C} \leq T_A \leq +70^\circ\text{C}$ (-J and -Z packages)		20	65	ppm/ $^\circ\text{C}$
		C grade, $-40 \leq T_A \leq +85^\circ\text{C}$ (-P and -S packages)		20	65	ppm/ $^\circ\text{C}$
LINE REGULATION ²	$\Delta V_O/\Delta V_{IN}$	A, E, H grades and nongraded, $V_{IN} = 8\text{ V to }36\text{ V}$		60	100	ppm/V
		A, E, H grades and nongraded, $V_{IN} = 8\text{ V to }36\text{ V}$, $0^\circ\text{C} \leq T_A \leq +70^\circ\text{C}$		70	120	ppm/V
		A, E, H grades and nongraded, $V_{IN} = 8\text{ V to }36\text{ V}$, $-55^\circ\text{C} \leq T_A \leq +125^\circ\text{C}$		90	150	ppm/V
		C grade, $V_{IN} = 8\text{ V to }36\text{ V}$		90	150	ppm/V
		C grade, $V_{IN} = 8\text{ V to }36\text{ V}$, $0^\circ\text{C} \leq T_A \leq +70^\circ\text{C}$ (-J and -Z packages)		110	180	ppm/V
		C grade, $V_{IN} = 8\text{ V to }36\text{ V}$, $-40^\circ\text{C} \leq T_A \leq +85^\circ\text{C}$ (-P and -S packages)		110	180	ppm/V
LOAD REGULATION ²	$\Delta V_O/\Delta I_{LOAD}$	A and E grades, $I_{LOAD} = 0\text{ mA to }10\text{ mA}$		60	100	ppm/mA
		A and E grades, $I_{LOAD} = 0\text{ mA to }8\text{ mA}$, $0^\circ\text{C} \leq T_A \leq +70^\circ\text{C}$		60	100	ppm/mA
		A and E grades, $I_{LOAD} = 0\text{ mA to }8\text{ mA}$, $-55^\circ\text{C} \leq T_A \leq +125^\circ\text{C}$		70	120	ppm/mA
		H grade and nongraded, $I_{LOAD} = 0\text{ mA to }10\text{ mA}$		60	100	ppm/mA
		H grade and nongraded, $I_{LOAD} = 0\text{ mA to }8\text{ mA}$, $0^\circ\text{C} \leq T_A \leq +70^\circ\text{C}$		70	120	ppm/mA
		H grade and nongraded, $I_{LOAD} = 0\text{ mA to }8\text{ mA}$, $-50^\circ\text{C} \leq T_A \leq +125^\circ\text{C}$		90	150	ppm/mA
		C grade, $I_{LOAD} = 0\text{ mA to }8\text{ mA}$		60	150	ppm/mA
		C grade, $I_{LOAD} = 0\text{ mA to }5\text{ mA}$, $0^\circ\text{C} \leq T_A \leq +70^\circ\text{C}$ (-J and -Z packages)		80	180	ppm/mA
		C grade, $I_{LOAD} = 0\text{ mA to }5\text{ mA}$, $-40^\circ\text{C} \leq T_A \leq +85^\circ\text{C}$ (-P and -S packages)		80	180	ppm/mA
DROPOUT VOLTAGE	V_{DO}			2	V	
QUIESCENT CURRENT	I_{IN}	A, E, H grades and nongraded		1.0	1.4	mA
		C grade		1.0	1.6	mA
LOAD CURRENT	I_{LOAD}	Sourcing			10	mA
		Sinking			8	mA
					-0.3	mA
SHORT CIRCUIT TO GND	I_{SC}	$V_O = 0\text{ V}$		30		mA
VOLTAGE NOISE	$e_{N\text{-P-P}}$	0.1 Hz to 10.0 Hz (-S, -Z and -P packages)		15		$\mu\text{V p-p}$
		0.1 Hz to 10.0 Hz (-J package)		20		$\mu\text{V p-p}$
LONG-TERM STABILITY ³	ΔV_O	After 1000 hours of operation		50		ppm
TURN-ON SETTLING TIME	t_R	Output settling to within $\pm 0.1\%$ of final value		5		μs
TEMPERATURE SENSOR ⁴	V_{TEMP} TCV_{TEMP}	Voltage Output at TEMP Pin		580		mV
		Temperature Sensitivity		1.96		mV/ $^\circ\text{C}$

¹ Refer to the Output Adjustment section.

² Specification includes the effects of self-heating.

³ Long-term stability is noncumulative; the drift in subsequent 1000-hour periods is significantly lower than in the first 1000-hour periods. Refer to the [Application Note AN-713](#).

⁴ Refer to the Temperature Monitoring section.

Data Sheet

REF01/REF02/REF03

REF03 SPECIFICATIONS

$V_{IN} = 15\text{ V}$, $-40^{\circ}\text{C} \leq T_A \leq +85^{\circ}\text{C}$, $I_{LOAD} = 0\text{ mA}$, unless otherwise noted.

Parameter	Symbol	Conditions	Min	Typ	Max	Unit
OUTPUT VOLTAGE	V_O		2.495	2.500	2.515	V
OUTPUT ADJUSTMENT RANGE ¹	ΔV_{TRIM}	POT = 10 k Ω	± 6	± 11		%
INITIAL ACCURACY	V_{OERR}				± 15 ± 0.6	mV %
TEMPERATURE COEFFICIENT	TCV_O			10	50	ppm/ $^{\circ}\text{C}$
LINE REGULATION ²	$\Delta V_O/\Delta V_{IN}$	$V_{IN} = 4.5\text{ V to }33\text{ V}$		20	50	ppm/V
LOAD REGULATION ²	$\Delta V_O/\Delta I_{LOAD}$	$I_{LOAD} = 0\text{ mA to }10\text{ mA}$		60	100	ppm/mA
DROPOUT VOLTAGE	V_{DO}				2	V
QUIESCENT CURRENT	I_{IN}			1.0	1.4	mA
LOAD CURRENT	I_{LOAD}					
Sourcing					10	mA
Sinking					-0.3	mA
SHORT CIRCUIT TO GND	I_{SC}	$V_O = 0\text{ V}$		24		mA
VOLTAGE NOISE	$e_{N\text{ p-p}}$	0.1 Hz to 10.0 Hz		6		$\mu\text{V p-p}$
LONG-TERM STABILITY ³	ΔV_O	After 1000 hours of operation		50		ppm
TURN-ON SETTLING TIME	t_R	Output settling to within $\pm 0.1\%$ of final value		5		μs
TEMPERATURE SENSOR ⁴						
Voltage Output at TEMP Pin	V_{TEMP}			580		mV
Temperature Sensitivity	TCV_{TEMP}			1.96		mV/ $^{\circ}\text{C}$

¹ Refer to the Output Adjustment section.

² Specification includes the effects of self-heating.

³ Long-term stability is noncumulative; the drift in subsequent 1000-hour periods is significantly lower than in the first 1000-hour periods. Refer to the [AN-713 Application Note](#).

⁴ Refer to the Temperature Monitoring section.

REF01/REF02/REF03

Data Sheet

ABSOLUTE MAXIMUM RATINGS

Table 2.

Parameter	Rating
Input Voltage	36.0 V
Output Short Circuit Duration	Indefinite
Operating Temperature Range	
REF01A, REF02A	–55°C to +125°C
REF01CP, REF01CS, REF01E, REF01H, REF02CP, REF02CS, REF02E, REF02H, REF03G	–40°C to +85°C
REF01CJ	0°C to +70°C
Storage Temperature Range	
–J, –S, –Z and –RC Packages	–65°C to +150°C
–P Package	–65°C to +125°C
Junction Temperature Range (T _J)	–65°C to +150°C
Lead Temperature (Soldering, 10 sec.)	300°C

Stresses at or above those listed under Absolute Maximum Ratings may cause permanent damage to the product. This is a stress rating only; functional operation of the product at these or any other conditions above those indicated in the operational section of this specification is not implied. Operation beyond the maximum operating conditions for extended periods may affect product reliability.

THERMAL RESISTANCE

θ_{JA} is specified for the worst-case conditions, that is, a device soldered in a circuit board for surface-mount packages.

Table 3. Thermal Resistance

Package Type	θ_{JA}	θ_{JC}	Unit
8-lead SOIC (S)	130	43	°C/W
8-lead PDIP (P)	110	50	°C/W
8-lead CERDIP (Z)	162	26	°C/W
TO-99 (J)	170	24	°C/W

ESD CAUTION



ESD (electrostatic discharge) sensitive device. Charged devices and circuit boards can discharge without detection. Although this product features patented or proprietary protection circuitry, damage may occur on devices subjected to high energy ESD. Therefore, proper ESD precautions should be taken to avoid performance degradation or loss of functionality.

PIN CONFIGURATIONS AND FUNCTION DESCRIPTIONS

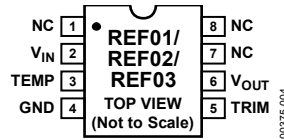

Figure 4. 8-Lead PDIP (P-Suffix), 8-Lead CERDIP (Z-Suffix), 8-Lead SOIC (S-Suffix) Pin Configuration

Table 4. Pin Function Descriptions—PDIP, CERDIP, and SOIC Packages

Pin No.	Mnemonic	Description
1, 7, 8	NC	No Internal Connection. Leave floating or tied to ground in actual application.
2	V _{IN}	Supply Voltage Input.
3	TEMP	Temperature (Band Gap) Output. Refer to the Temperature Monitoring section.
4	GND	Ground Connection.
5	TRIM	Output Voltage Trim. Refer to the Output Adjustment section.
6	V _{OUT}	Reference Voltage Output.

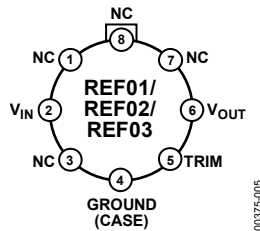

Figure 5. 8-Lead TO-99 (J-Suffix) Pin Configuration

Table 5. Pin Function Descriptions—8-Lead TO-99 Package

Pin No.	Mnemonic	Description
1, 3, 7, 8	NC	No Internal Connection. Leave floating or tied to ground in actual application.
2	V _{IN}	Supply Voltage Input.
4	GND	Ground Connection.
5	TRIM	Output Voltage Trim. Refer to the Output Adjustment section.
6	V _{OUT}	Reference Voltage Output.

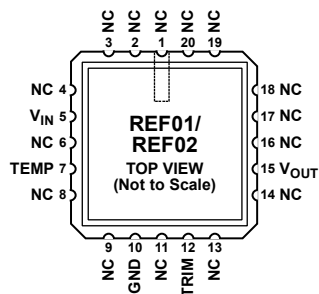

Figure 6. 20-Terminal LCC (RC-Suffix) Pin Configuration

Table 6. Pin Function Descriptions—20-Terminal LCC Package

Terminal No.	Mnemonic	Description
1 to 4, 6, 8, 9, 11, 13, 14, 16 to 20	NC	No Internal Connection. Leave floating or tied to ground in actual application.
5	V _{IN}	Supply Voltage Input.
7	TEMP	Temperature (Band Gap) Output. Refer to the Temperature Monitoring section.
10	GND	Ground Connection.
12	TRIM	Output Voltage Trim. Refer to the Output Adjustment section.
15	V _{OUT}	Reference Voltage Output.

REF01/REF02/REF03

Data Sheet

TYPICAL PERFORMANCE CHARACTERISTICS

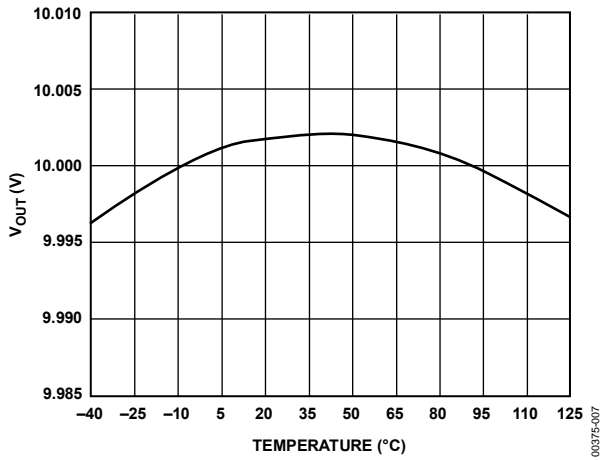

Figure 7. REF01 Typical Output Voltage vs. Temperature

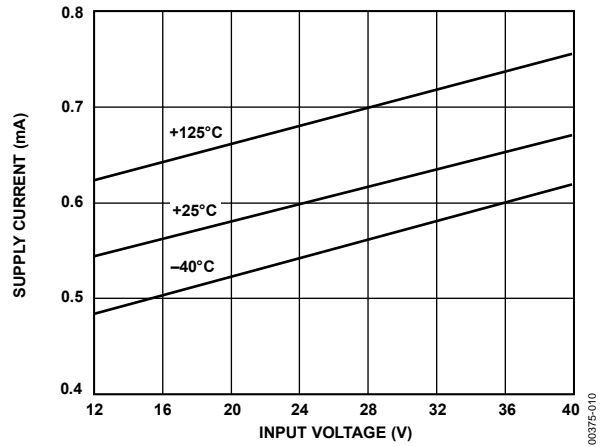

Figure 10. REF01 Supply Current vs. Input Voltage

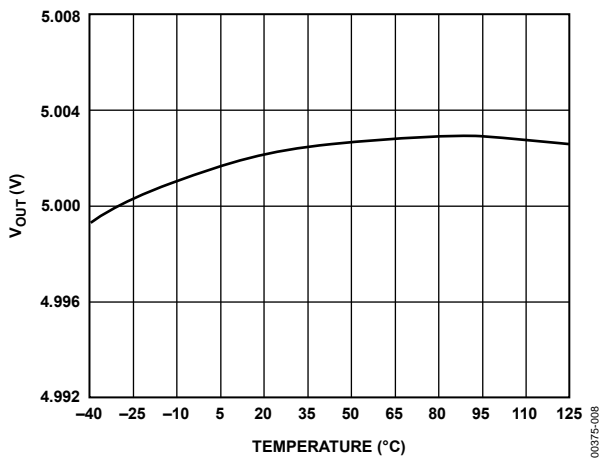

Figure 8. REF02 Typical Output Voltage vs. Temperature

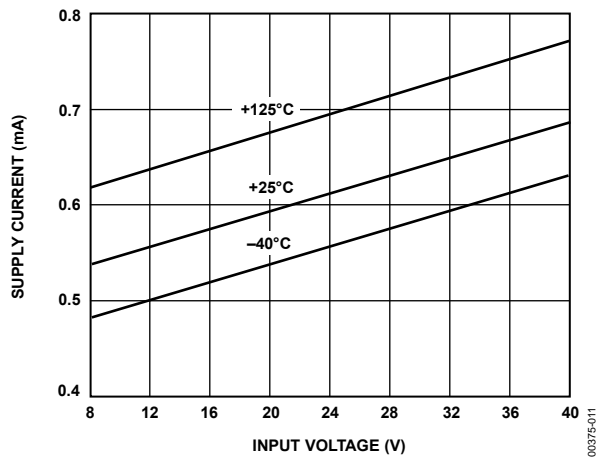

Figure 11. REF02 Supply Current vs. Input Voltage

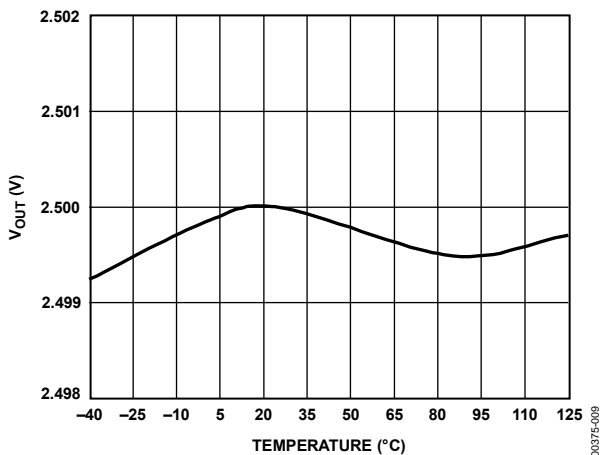

Figure 9. REF03 Typical Output Voltage vs. Temperature

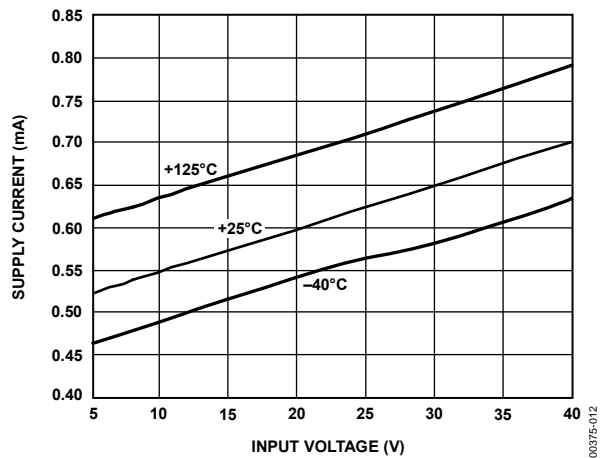

Figure 12. REF03 Supply Current vs. Input Voltage

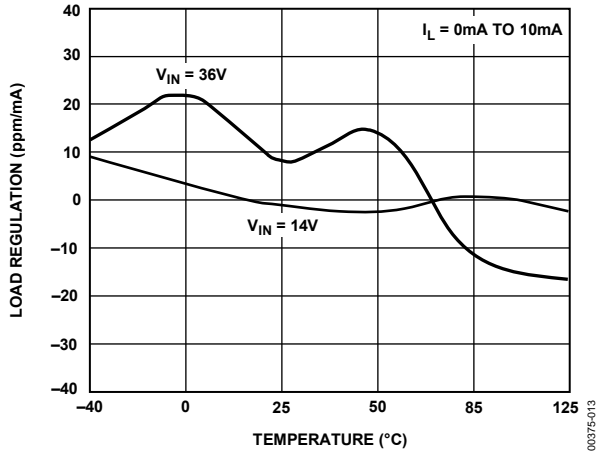

Figure 13. REF01 Load Regulation vs. Temperature

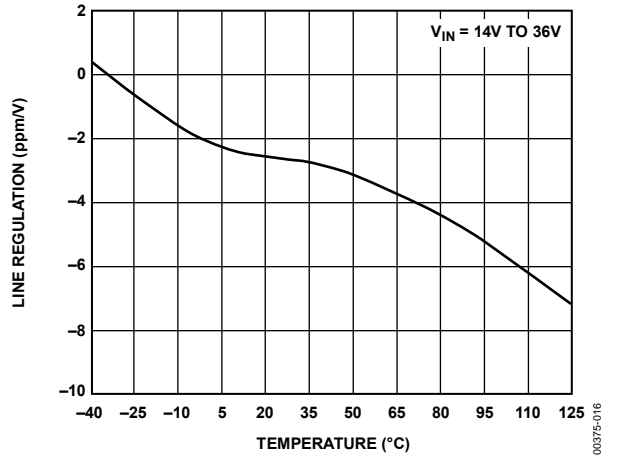

Figure 16. REF01 Line Regulation vs. Temperature

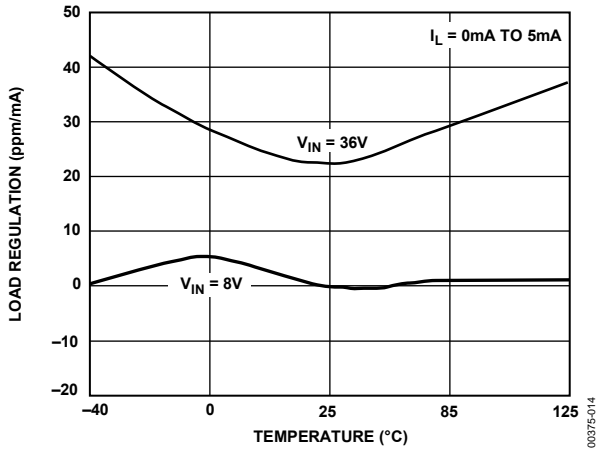

Figure 14. REF02 Load Regulation vs. Temperature

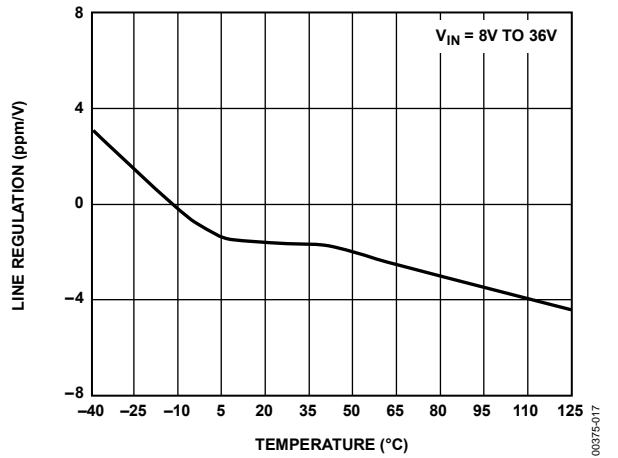

Figure 17. REF02 Line Regulation vs. Temperature

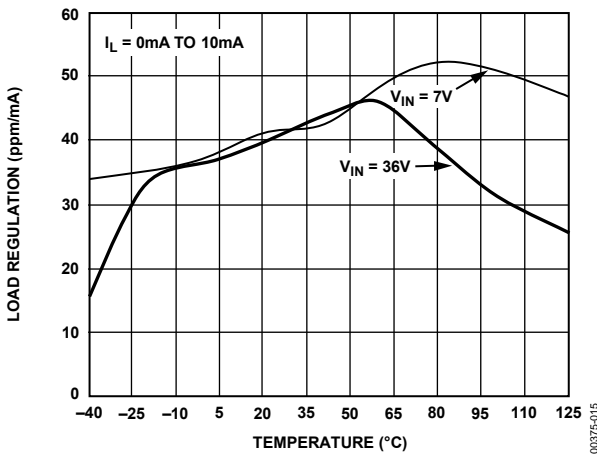

Figure 15. REF03 Load Regulation vs. Temperature

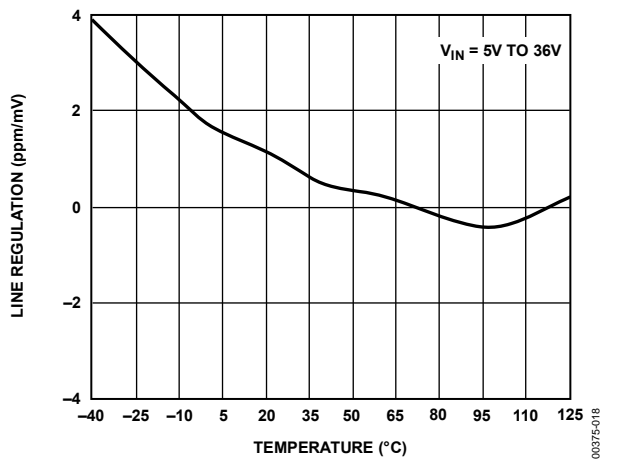

Figure 18. REF03 Line Regulation vs. Temperature

REF01/REF02/REF03

Data Sheet

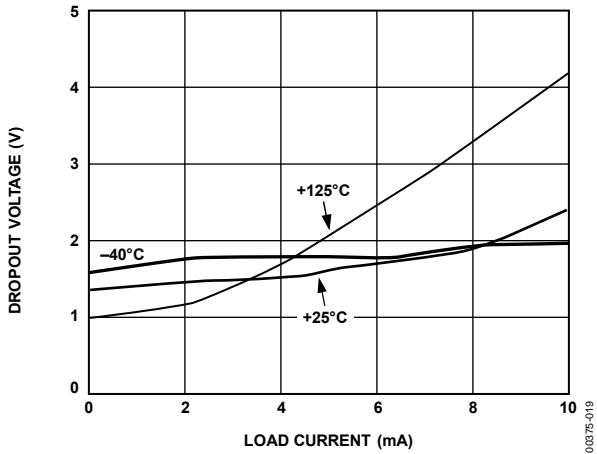

Figure 19. REF01 Dropout Voltage vs. Load Current

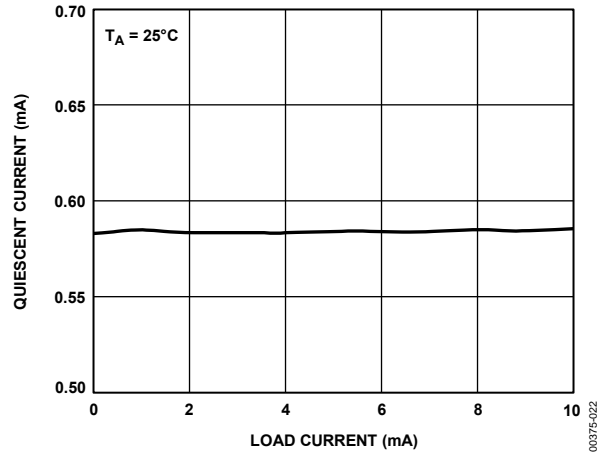

Figure 22. REF01 Quiescent Current vs. Load Current

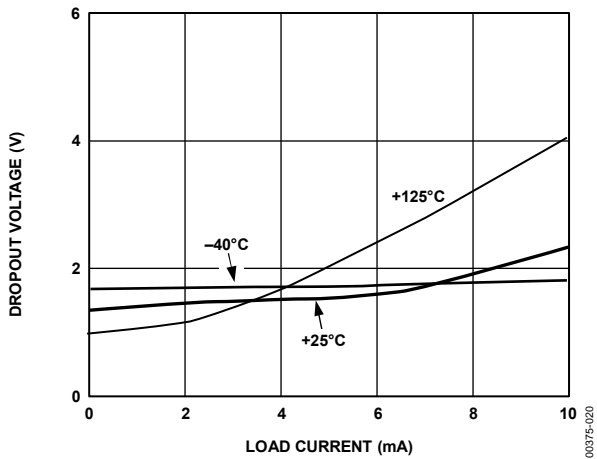

Figure 20. REF02 Dropout Voltage vs. Load Current

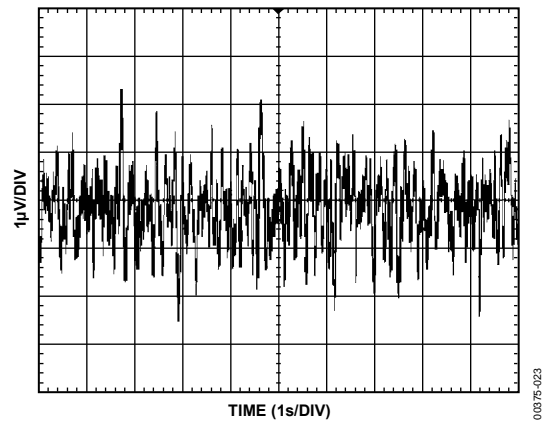

Figure 23. REF02 Typical Low-Frequency Voltage Noise (0.1 Hz to 10.0 Hz)

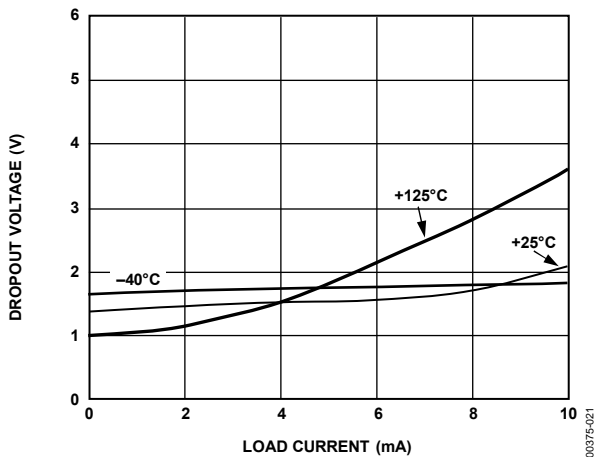

Figure 21. REF03 Dropout Voltage vs. Load Current

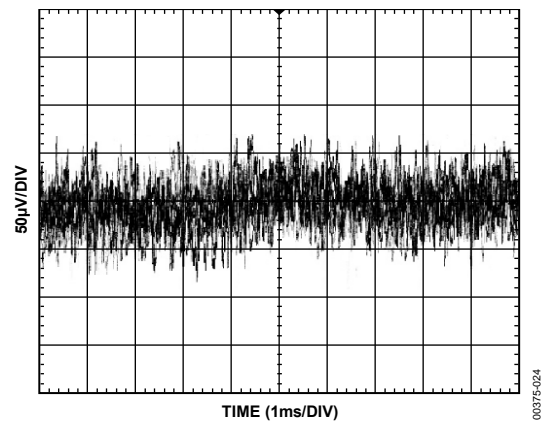

Figure 24. REF02 Typical Wideband Voltage Noise (10 Hz to 10 kHz)

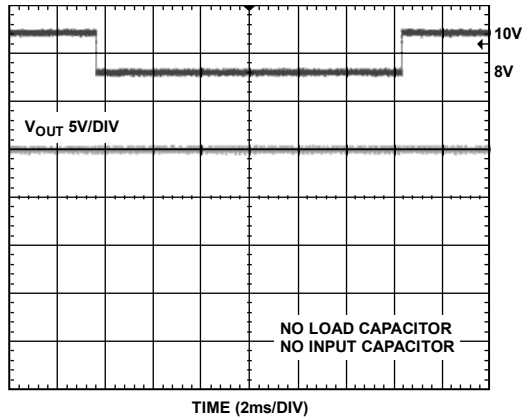

Figure 25. REF02 Line Transient Response

00375-025

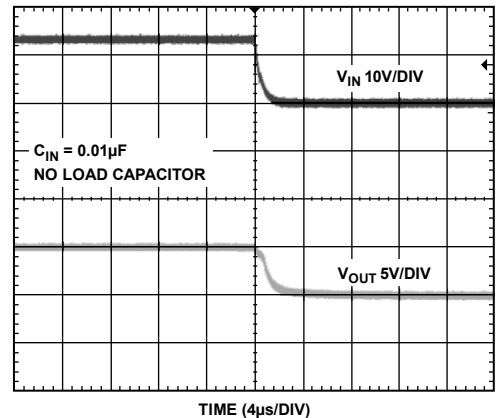

Figure 28. REF02 Turn-Off Response

00375-028

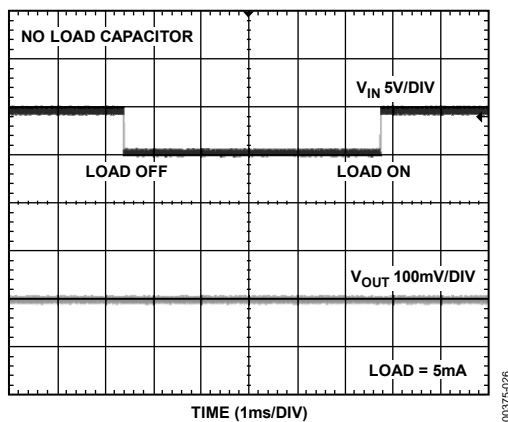

Figure 26. REF02 Load Transient Response

00375-026

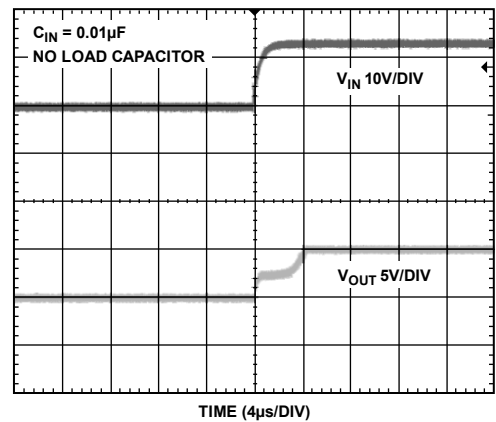

Figure 29. REF02 Turn-On Response

00375-029

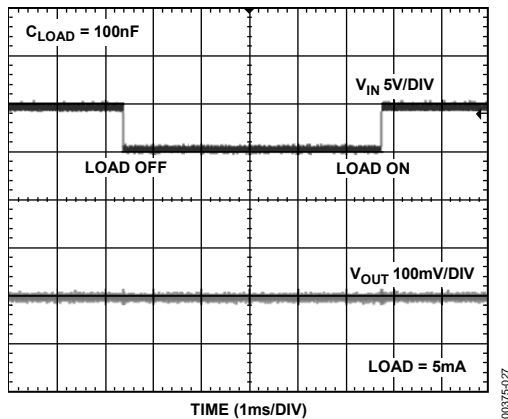

Figure 27. REF02 Load Transient Response

00375-027

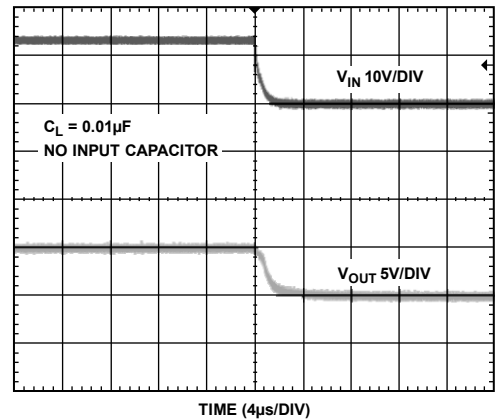
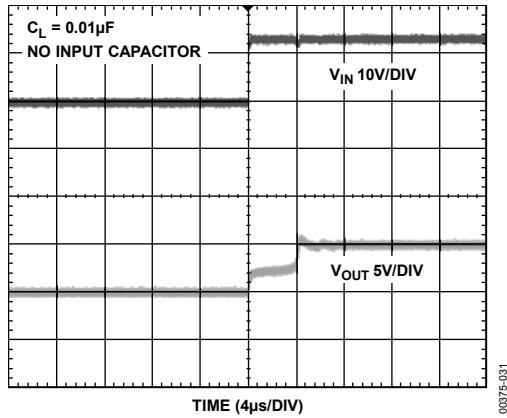

Figure 30. REF02 Turn-Off Response (No Input Capacitor)

00375-030

REF01/REF02/REF03

Data Sheet



00375-031

Figure 31. REF02 Turn-Off Response (No Input Capacitor)

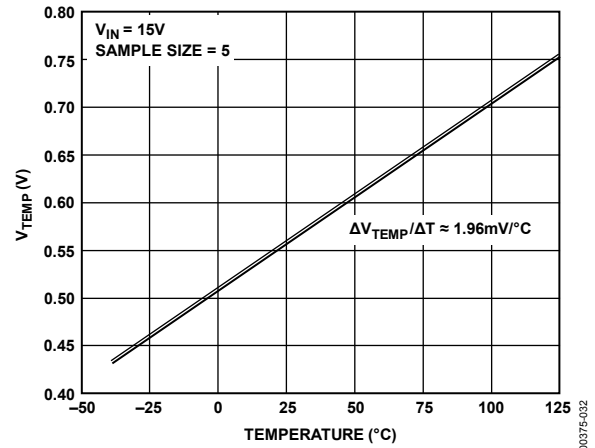

00375-032

Figure 32. Output Voltage at TEMP Pin vs. Temperature

TERMINOLOGY

Dropout Voltage (V_{DO})

Dropout voltage, sometimes referred to as supply voltage headroom or supply-output voltage differential, is defined as the minimum voltage differential between the input and output necessary for the device to operate.

$$V_{DO} = (V_{IN} - V_{OUT})_{\min} \Big|_{I_L = \text{constant}}$$

Since the dropout voltage depends upon the current passing through the device, it is always specified for a given load current.

Temperature Coefficient (TCV_O)

The temperature coefficient relates the change in output voltage to the change in ambient temperature of the device, as normalized by the output voltage at 25°C. This parameter is expressed in ppm/°C and can be determined by the following equation:

$$TCV_{OUT} = \frac{V_{OUT}(T_2) - V_{OUT}(T_1)}{V_{OUT}(25^\circ\text{C}) \times (T_2 - T_1)} \times 10^6 \text{ [ppm/}^\circ\text{C]}$$

where:

$V_{OUT}(25^\circ\text{C})$ is output voltage at 25°C.

$V_{OUT}(T_1)$ is output voltage at temperature 1.

$V_{OUT}(T_2)$ is output voltage at temperature 2.

Thermally Induced Output Voltage Hysteresis (ΔV_{OUT_HYS})

Thermally induced output voltage hysteresis represents the change in output voltage after the device is exposed to a specified temperature cycle. This may be expressed as either a shift in voltage or a difference in ppm from the nominal output.

$$V_{OUT_HYS} = V_{OUT}(25^\circ\text{C}) - V_{OUT_TC} \text{ [V]}$$

$$V_{OUT_HYS} = \frac{V_{OUT}(25^\circ\text{C}) - V_{OUT_TC}}{V_{OUT}(25^\circ\text{C})} \times 10^6 \text{ [ppm]}$$

where:

$V_{OUT}(25^\circ\text{C})$ is output voltage at 25°C.

V_{OUT_TC} is output voltage after temperature cycling.

Thermal hysteresis occurs mainly as a result of forces exhibited upon the internal die by its packaging. The effect is more pronounced in devices with smaller packages.

Long-Term Stability (ΔV_{OUT_LTD})

Long-term stability refers to the shift in output voltage at 25°C after 1000 hours of operation in a 25°C environment. This may also be expressed as either a shift in voltage or a difference in ppm from the nominal output.

$$\Delta V_{OUT_LTD} = |V_{OUT}(t_1) - V_{OUT}(t_0)| \text{ [V]}$$

$$\Delta V_{OUT_LTD} = \left| \frac{V_{OUT}(t_1) - V_{OUT}(t_0)}{V_{OUT}(t_0)} \right| \times 10^6 \text{ [ppm]}$$

where:

$V_{OUT}(t_0)$ is V_{OUT} at 25°C at time 0.

$V_{OUT}(t_1)$ is V_{OUT} at 25°C after 1000 hours of operation at 25°C.

Line Regulation

Line regulation refers to the change in output voltage in response to a given change in input voltage. It is expressed in either percent per volt, ppm per volt, or microvolt per volt change in input voltage. This parameter accounts for the effects of self-heating.

Load Regulation

Load regulation refers to the change in output voltage in response to a given change in load current, and is expressed in either microvolts per milliamp, ppm per milliamp, or ohms of dc output resistance. This parameter accounts for the effects of self-heating.

REF01/REF02/REF03

Data Sheet

THEORY OF OPERATION

REF01, **REF02**, and **REF03** are high precision, low drift 10.0 V, 5.0 V, and 2.5 V voltage references available in a variety of packages. These devices are standard band gap references (see Figure 33). The band gap cell contains two NPN transistors (Q18 and Q19) that differ in emitter area by a factor of 2. The difference in the V_{BE} values of these transistors produces a proportional-to-absolute temperature current (PTAT) through R14, and, when combined with the V_{BE} of Q19, produces a band gap voltage, V_{BG} , that is almost constant over temperature.

With an internal op amp and the feedback network created by R5 and R6, V_O is set precisely at 10.0 V, 5.0 V, or 2.5 V. Precision laser trimming of various resistors and other proprietary circuit techniques are used to further enhance the initial accuracy, temperature curvature, and drift performance of the device.

The PTAT voltage is brought out directly from the band gap, unbuffered, at the TEMP pin. Since this voltage output has a stable 1.96 mV/°C temperature coefficient, users can estimate the temperature change of the device by simply monitoring the change in voltage at this pin.

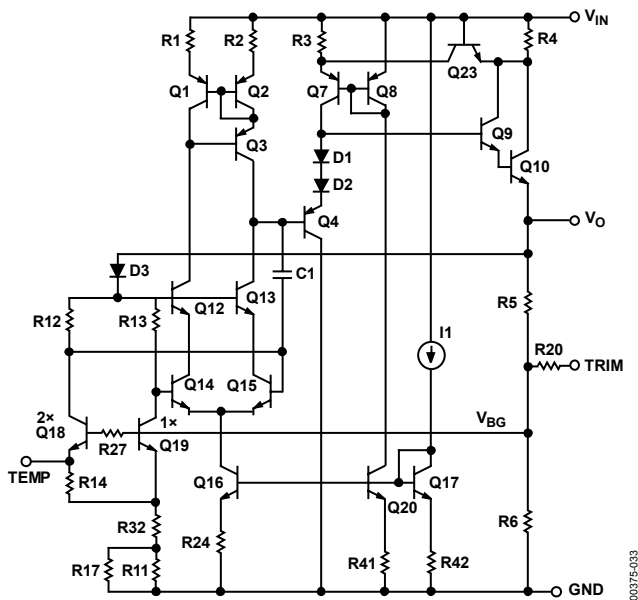

Figure 33. REF01/REF02/REF03 Simplified Schematic

INPUT AND OUTPUT CAPACITORS

Figure 34 shows the basic input/output capacitor configuration for the **REF01/REF02/REF03** series of references.

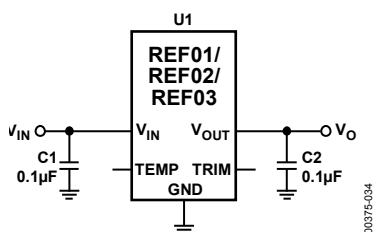

Figure 34. Basic REF01/REF02/REF03 Capacitor Configuration

While the **REF01/REF02/REF03** series of references are designed to function stably without any external components, connecting a 0.1 µF ceramic capacitor to the output is highly recommended to improve stability and filter out low level voltage noise. An additional 1 µF to 10 µF electrolytic, tantalum, or ceramic capacitor can be added in parallel to improve transient performance in response to sudden changes in load current; however, the designer should keep in mind that doing so increases the turn-on time of the device.

A 1 µF to 10 µF electrolytic, tantalum, or ceramic capacitor can also be connected to the input to improve transient response in applications where the supply voltage may fluctuate. An additional 0.1 µF ceramic capacitor should be connected in parallel to reduce supply noise.

Both input and output capacitors should be mounted as close to the device pins as possible.

OUTPUT ADJUSTMENT

The **REF01/REF02/REF03** trim terminal can be used to adjust the output up or down from the internally trimmed, nominal output voltage. This feature allows the system designer to trim out system errors due to changes in line and load conditions, thermal hysteresis, output offset due to solder reflow, or other error sources. The basic trim circuit configuration is shown in Figure 35.

Table 7 also lists the range of output voltages obtainable from each model in this configuration.

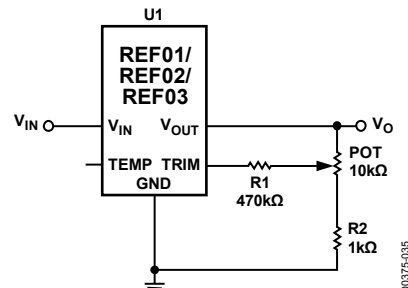

Figure 35. Optional Trim Adjustment Circuit

Table 7. Adjustment Range Using Trim Circuit

Model	V_{OUT} , Low Limit	V_{OUT} , High Limit
REF01	9.70 V	10.05 V
REF02	4.95 V	5.02 V
REF03	2.3 V	2.8 V

Adjustment of the output does not significantly affect the temperature performance of the reference itself, provided the temperature coefficients of the resistors used are low.

TEMPERATURE MONITORING

In addition to the optional TRIM function, the REF01/REF02/REF03 series of references provides the ability to monitor changes in temperature by way of tracking the voltage present at the TEMP pin. The output voltage of this pin is taken directly from the band gap core and, as a result, varies linearly with temperature. The nominal voltage at the TEMP pin (V_{TEMP}) is approximately 550 mV at 25°C, with a temperature coefficient (TCV_{TEMP}) of approximately 1.96 mV/°C. Refer to Figure 32 for a graph of output voltage vs. temperature.

As an example, given these ideal values, a voltage change of 39.2 mV at the TEMP pin corresponds to a 20°C change in temperature.

The TEMP function is provided as a convenience, rather than a precise feature, of the reference. In addition, because the voltage at the TEMP pin is taken directly from the band gap core, any current injected into or pulled from this pin has a significant effect on V_{OUT} . As such, even tens of microamps drawn from the TEMP pin can cause the output to fall out of regulation. Should the designer wish to take advantage of this feature, it is necessary to buffer the output of the TEMP pin with a low bias current op amp, such as the AD8601 or AD8641. Any of these op amps, if used as shown in Figure 36, causes less than a 100 μ V change in V_{OUT} .

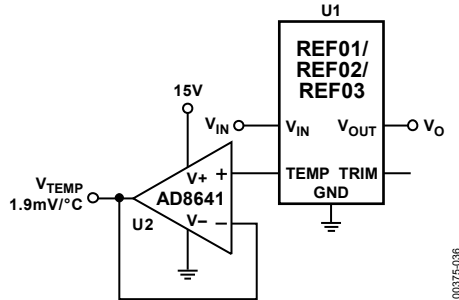

Figure 36. Temperature Monitoring

LONG-TERM STABILITY

One of the key parameters of the REF01/REF02/REF03 series of references is long-term stability. Regardless of output voltage, internal testing during development showed a typical drift of approximately 50 ppm after 1,000 hours of continuous, nonloaded operation in a +25°C environment.

It is important to understand that long-term stability is not guaranteed by design, and that the output from the device may shift beyond the typical 50 ppm specification at any time, especially during the first 200 hours of operation. For systems that require highly stable output over long periods of time, the designer should consider burning-in the devices prior to use to minimize the amount of output drift exhibited by the reference over time. Refer

to the AN-713 Application Note for more information regarding the effects of long-term drift and how it can be minimized.

BURN-IN

Burn-in, wherein the device is powered and allowed to operate normally for an extended period of time, can be useful for minimizing the effects of long-term drift. A sample burn-in circuit is shown below in Figure 37.

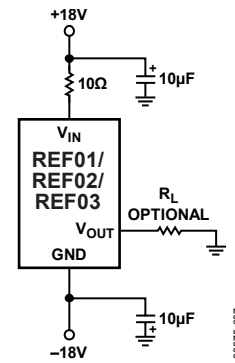

Figure 37. Burn-In Circuit

The device may be burned in with or without a constant resistive load. The load current should not exceed 10 mA.

POWER DISSIPATION

The REF01/REF02/REF03 series of voltage references are capable of sourcing up to 10 mA of load current at room temperature across the rated input voltage range. However, when used in applications subject to high ambient temperatures, the input voltage and load current should be carefully monitored to ensure that the device does not exceed its maximum power dissipation rating. The maximum power dissipation of the device can be calculated via the following equation:

$$P_D = \frac{T_j - T_A}{\theta_{JA}} \text{ [W]}$$

where:

P_D is device power dissipation.

T_j is device junction temperature.

T_A is ambient temperature.

θ_{JA} is package (junction-to-air) thermal resistance.

Because of this relationship, acceptable load current in high-temperature conditions may be less than the maximum current-sourcing capability of the device. In no case should the device be operated outside of its maximum power rating as doing so may result in premature failure or permanent damage to the device.

REF01/REF02/REF03

Data Sheet

APPLICATIONS INFORMATION

BASIC REFERENCE APPLICATION

Figure 38 shows the basic configuration for any REF01/REF02/REF03 device. Input and output capacitance values can be tailored for performance, provided they follow the guidelines described in the Input and Output Capacitors section.

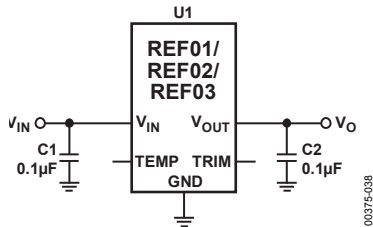

Figure 38. Basic Reference Application

LOW COST CURRENT SOURCE

Unlike most references, the quiescent current of the REF01/REF02/REF03 series remains constant with respect to the load current (refer to Figure 22). As a result, a simple, low cost current source can be constructed by configuring the reference as shown in Figure 39.

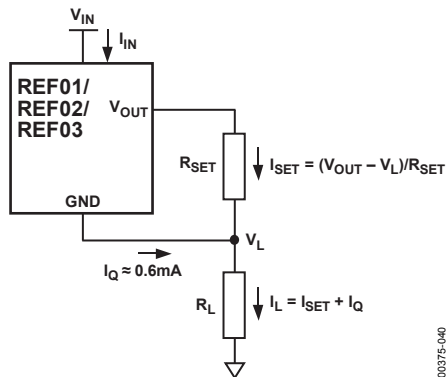

Figure 39. Simple Current Source

In this configuration, the current through the resistor R_{SET} (I_{SET}) is equal to $(V_{OUT} - V_L)/R_{SET}$. I_L is simply the sum of I_{SET} and I_Q . However, since I_Q typically varies from 0.55 mA to 0.65 mA, this circuit should be limited to low precision, general-purpose applications.

PRECISION CURRENT SOURCE WITH ADJUSTABLE OUTPUT

A higher-precision current source can be implemented with the circuit shown in Figure 40.

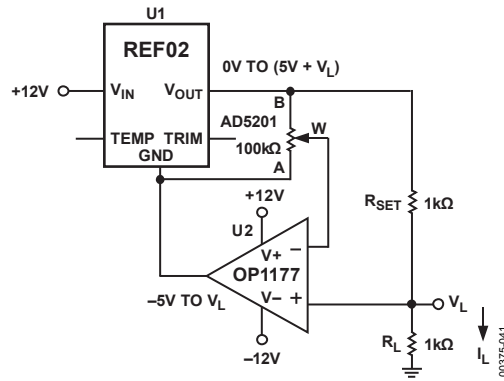

Figure 40. Programmable 0 mA to 5 mA Current Source

By adding a mechanical or digital potentiometer, this circuit becomes an adjustable current source. If a digital potentiometer is used, the load current is simply the voltage across terminal B to terminal W of the digital potentiometer divided by the value of the resistor R_{SET} .

$$I_L = \frac{V_{REF} \times D}{R_{SET}} [A]$$

where D is the decimal equivalent of the digital potentiometer input code.

A dual-supply op amp should be used since the ground potential of REF02 can swing from -5.0 V to V_L while the potentiometer is swung from zero-scale to full-scale.

PRECISION BOOSTED OUTPUT REGULATOR

The output current sourcing capability of the REF01/REF02/REF03 series can be boosted by using an external op amp and MOSFET, as shown in Figure 41.

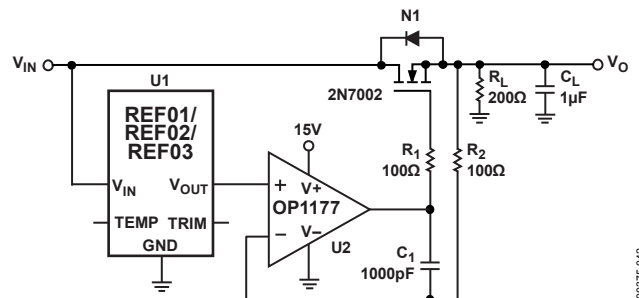

Figure 41. Precision Boosted Output Regulator

In this circuit, U_2 forces V_O to V_{REF} by regulating the current through N_1 , thereby sourcing the load current directly from the input voltage source connected at V_{IN} . Using the components shown, this circuit can source up to 50 mA with an input voltage of 15.0 V. The circuit's current sourcing capability can be further increased by replacing N_1 with a higher-power MOSFET.

BIPOLAR VOLTAGE REFERENCE

Many applications require both a positive and reference voltage of the same magnitude. A simple method of generating such a bipolar reference is shown in Figure 42.

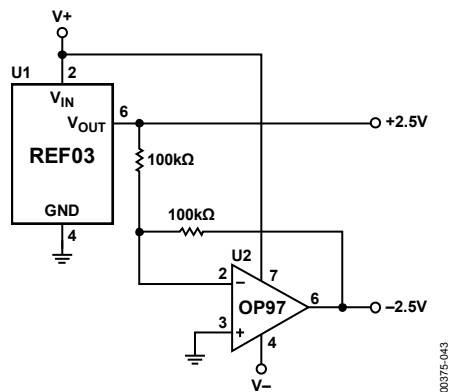

Figure 42. Bipolar Voltage Reference

In this configuration, the negative rail is generated simply with an inverting amplifier with a gain of -1 . A low offset op amp should be used to minimize the voltage error at the negative output.

ADJUSTABLE REFERENCE WITH POSITIVE AND NEGATIVE SWING

The output voltage of the REF01/REF02/REF03 references can be readily adjusted via a simple trim circuit (explained in the Output Adjustment section). The circuit shown in Figure 43 extends the negative range of adjustment beyond that obtainable with the simple trim circuit by employing a precision op amp with a potentiometer feeding the op amp's noninverting input.

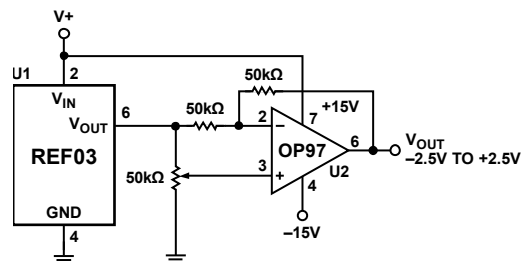
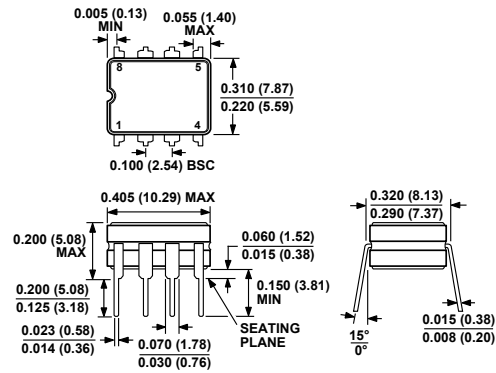

Figure 43. Negatively Adjustable Reference

The voltage output from the op amp can be adjusted by changing the value of the potentiometer: as shown, the op amp outputs $+2.5$ V when the pot is pulled completely high, and -2.5 V when pulled completely low. In this configuration, the load current is sourced by the op amp; therefore, a low offset op amp with a current rating that meets or exceeds the current requirements of the load should be used.

OUTLINE DIMENSIONS



CONTROLLING DIMENSIONS ARE IN INCHES; MILLIMETER DIMENSIONS (IN PARENTHESES) ARE ROUNDED-OFF INCH EQUIVALENTS FOR REFERENCE ONLY AND ARE NOT APPROPRIATE FOR USE IN DESIGN.

Figure 44. 8-Lead Ceramic Dual In-Line Package [CERDIP] Z-Suffix (Q-8)
Dimensions shown in inches and (millimeters)

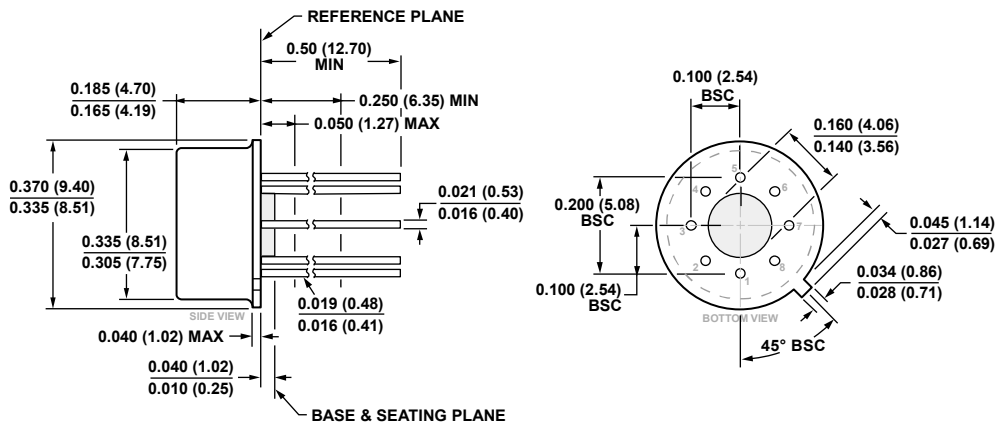

COMPLIANT TO JEDEC STANDARDS MO-002-AK
CONTROLLING DIMENSIONS ARE IN INCHES; MILLIMETER DIMENSIONS (IN PARENTHESES) ARE ROUNDED-OFF INCH EQUIVALENTS FOR REFERENCE ONLY AND ARE NOT APPROPRIATE FOR USE IN DESIGN.

Figure 45. 8-Pin Metal Header Package [TO-99] J-Suffix (H-08)
Dimensions shown in inches and (millimeters)

01-16-2016-B

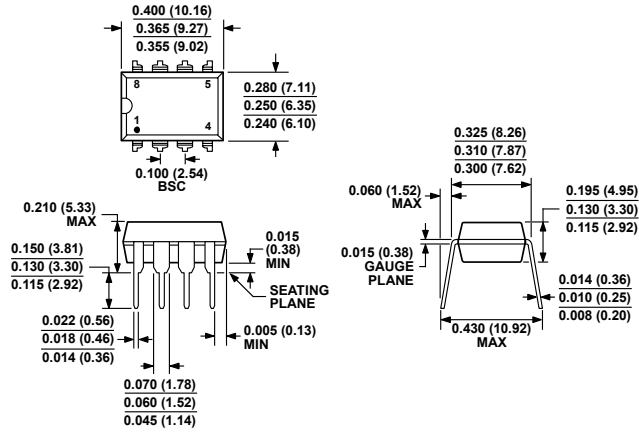

COMPLIANT TO JEDEC STANDARDS MS-001
 CONTROLLING DIMENSIONS ARE IN INCHES; MILLIMETER DIMENSIONS (IN PARENTHESES) ARE ROUNDED-OFF INCH EQUIVALENTS FOR REFERENCE ONLY AND ARE NOT APPROPRIATE FOR USE IN DESIGN. CORNER LEADS MAY BE CONFIGURED AS WHOLE OR HALF LEADS.

Figure 46. 8-Lead Plastic Dual In-Line Package [PDIP] Narrow Body, P-Suffix (N-8)
 Dimensions shown in inches and (millimeters)

070069-A

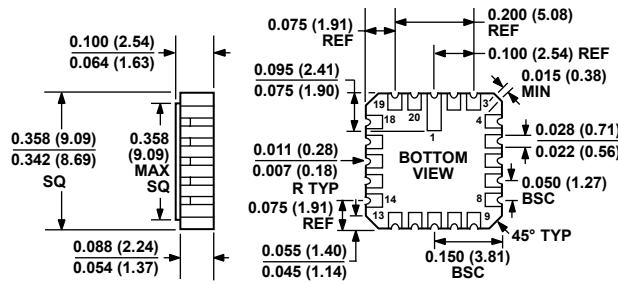

CONTROLLING DIMENSIONS ARE IN INCHES; MILLIMETER DIMENSIONS (IN PARENTHESES) ARE ROUNDED-OFF INCH EQUIVALENTS FOR REFERENCE ONLY AND ARE NOT APPROPRIATE FOR USE IN DESIGN.

Figure 47. 20-Terminal Ceramic Leadless Chip Carrier [LCC] RC-Suffix (E-20-1)
 Dimensions shown in inches and (millimeters)

022106-A

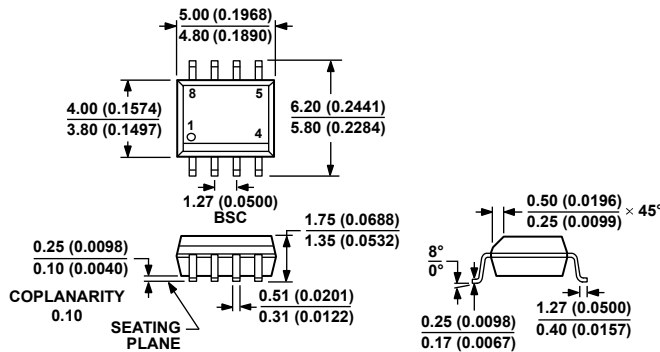

COMPLIANT TO JEDEC STANDARDS MS-012-AA
 CONTROLLING DIMENSIONS ARE IN MILLIMETERS; INCH DIMENSIONS (IN PARENTHESES) ARE ROUNDED-OFF MILLIMETER EQUIVALENTS FOR REFERENCE ONLY AND ARE NOT APPROPRIATE FOR USE IN DESIGN.

Figure 48. 8-Lead Standard Small Outline Package [SOIC_N] Narrow Body, S-Suffix (R-8)
 Dimensions shown in millimeters and (inches)

012407-A

REF01/REF02/REF03

Data Sheet

REF01 ORDERING GUIDE

Model ^{1, 2}	Initial Accuracy (mV)	Temperature Range	Package Description	Package Option
REF01AJ/883C	±30	–55°C to +125°C	8-Pin TO-99	J-Suffix (H-08)
REF01CJ	±100	0°C to 70°C	8-Pin TO-99	J-Suffix (H-08)
REF01EZ	±30	–40°C to +85°C	8-Lead CERDIP	Z-Suffix (Q-8)
REF01HZ	±50	–40°C to +85°C	8-Lead CERDIP	Z-Suffix (Q-8)
REF01CPZ	±100	–40°C to +85°C	8-Lead PDIP	P-Suffix (N-8)
REF01HPZ	±50	–40°C to +85°C	8-Lead PDIP	P-Suffix (N-8)
REF01CSZ	±100	–40°C to +85°C	8-Lead SOIC_N	S-Suffix (R-8)
REF01CSZ-REEL	±100	–40°C to +85°C	8-Lead SOIC_N	S-Suffix (R-8)
REF01CSZ-REEL7	±100	–40°C to +85°C	8-Lead SOIC_N	S-Suffix (R-8)

¹ Contact sales for 883 data sheet.

² The REF01CPZ, REF01HPZ, REF01CSZ, REF01CSZ-REEL, and REF01CSZ-REEL7 are RoHS Compliant Parts.

REF02 ORDERING GUIDE

Model ^{1, 2}	Initial Accuracy (mV)	Temperature Range	Package Description	Package Option
REF02AJ/883C	±15	–55°C to +125°C	8-Pin TO-99	J-Suffix (H-08)
REF02AZ	±15	–55°C to +125°C	8-Lead CERDIP	Z-Suffix (Q-8)
REF02AZ/883C	±15	–55°C to +125°C	8-Lead CERDIP	Z-Suffix (Q-8)
REF02CPZ	±50	–40°C to +85°C	8-Lead PDIP	P-Suffix (N-8)
REF02CSZ	±50	–40°C to +85°C	8-Lead SOIC_N	S-Suffix (R-8)
REF02CSZ-REEL	±50	–40°C to +85°C	8-Lead SOIC_N	S-Suffix (R-8)
REF02CSZ-REEL7	±50	–40°C to +85°C	8-Lead SOIC_N	S-Suffix (R-8)
REF02EZ	±15	–40°C to +85°C	8-Lead CERDIP	Z-Suffix (Q-8)
REF02HZ	±25	–40°C to +85°C	8-Lead CERDIP	Z-Suffix (Q-8)
REF02HPZ	±25	–40°C to +85°C	8-Lead PDIP	P-Suffix (N-8)
REF02HSZ	±25	–40°C to +85°C	8-Lead SOIC_N	S-Suffix (R-8)
REF02RC/883C	±25	–55°C to +125°C	20-Terminal LCC	RC-Suffix (E-20-1)
REF02Z	±25	–55°C to +125°C	8-Lead CERDIP	Z-Suffix (Q-8)

¹ Contact sales for 883 data sheet.

² The REF02CPZ, REF02CSZ, REF02CSZ-REEL, REF02CSZ-REEL7, REF02HPZ, and REF02HSZ are RoHS Compliant Parts.

REF03 ORDERING GUIDE

Model ¹	Initial Accuracy (mV)	Temperature Range	Package Description	Package Option
REF03GPZ	±15	–40°C to +85°C	8-Lead PDIP	P-Suffix (N-8)
REF03GSZ	±15	–40°C to +85°C	8-Lead SOIC_N	S-Suffix (R-8)
REF03GSZ-REEL7	±15	–40°C to +85°C	8-Lead SOIC_N	S-Suffix (R-8)

¹ Z = RoHS Compliant Part.

OUR CERTIFICATE

DiGi provide top-quality products and perfect service for customer worldwide through standardization, technological innovation and continuous improvement. DiGi through third-party certification, we stricly control the quality of products and services. Welcome your RFQ to

Email: Info@DiGi-Electronics.com



Tel: +00 852-30501935

RFQ Email: Info@DiGi-Electronics.com

DiGi is a global authorized distributor of electronic components.