

LSHD-5503 Datasheet

www.digi-electronics.com

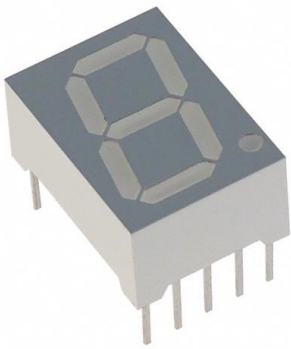

<https://www.DiGi-Electronics.com>

DiGi Electronics Part Number	LSHD-5503-DG
Manufacturer	Lite-On Inc.
Manufacturer Product Number	LSHD-5503
Description	DISPLAY 7SEG 0.56" SGL RED 10DIP
Detailed Description	Display Modules - LED Character and Numeric Red 7-Segment 1 Character Common Cathode 2.1V 20mA 0.673" H x 0.488" W x 0.315" D (17.10mm x 12.40mm x 8.00mm) 10-DIP (0.600", 15.24mm)

This model LSHD-5503 is available at DiGi Electronics.

DiGi Electronics offers a global database of semiconductor and electronic component datasheets.

We welcome your inquiries regarding pricing, lead time, or other product-related questions.

 [Request a Quote](#)

 [Datasheet Search](#)



Tel: +00 852-30501935

RFQ Email: Info@DiGi-Electronics.com

DiGi is a global authorized distributor of electronic components.

Purchase and inquiry

Manufacturer Product Number:

LSHD-5503

Series:

-

Number of Characters:

1

Digit/Alpha Size:

0.56" (14.22mm)

Common Pin:

Common Cathode

Voltage - Forward (Vf) (Typ):

2.1V

Millicandela Rating:

17mcd

Power Dissipation (Max):

70mW

Base Product Number:

LSHD-55

Manufacturer:

Lite-On Inc.

Product Status:

Active

Size / Dimension:

0.673" H x 0.488" W x 0.315" D (17.10mm x 12.40mm x 8.00mm)

Display Type:

7-Segment

Color:

Red

Current - Test:

20mA

Wavelength - Peak:

632nm

Package / Case:

10-DIP (0.600", 15.24mm)

Environmental & Export classification

RoHS Status:

ROHS3 Compliant

REACH Status:

REACH Affected

HTSUS:

8541.41.0000

Moisture Sensitivity Level (MSL):

1 (Unlimited)

ECCN:

EAR99

LITEON LITE-ON TECHNOLOGY CORPORATION

Property of Lite-On Only

FEATURES

- * 0.56 inch (14.22 mm) DIGIT HEIGHT
- * EXCELLENT SEGMENT UNIFORMITY
- * LOW POWER REQUIREMENT
- * HIGH BRIGHTNESS AND HIGH CONTRAST
- * WIDE VIEWING ANGLE
- * SOLID STATE RELIABILITY
- * BINNED FOR LUMINOUS INTENSITY

DESCRIPTION

The LSHD-5503 is a 0.56 inch (14.22 mm) digit height single-digit display. This device uses AS-AlInGaP RED LED chips (AlInGaP epi on GaAs substrate). The display has light gray face and white segments.

DEVICE

PART NO.	DESCRIPTION
AlInGaP RED	Common Cathode
LSHD-5503	Rt. Hand Decimal

LITEON LITE-ON TECHNOLOGY CORPORATION

Property of Lite-On Only

PACKAGE DIMENSIONS

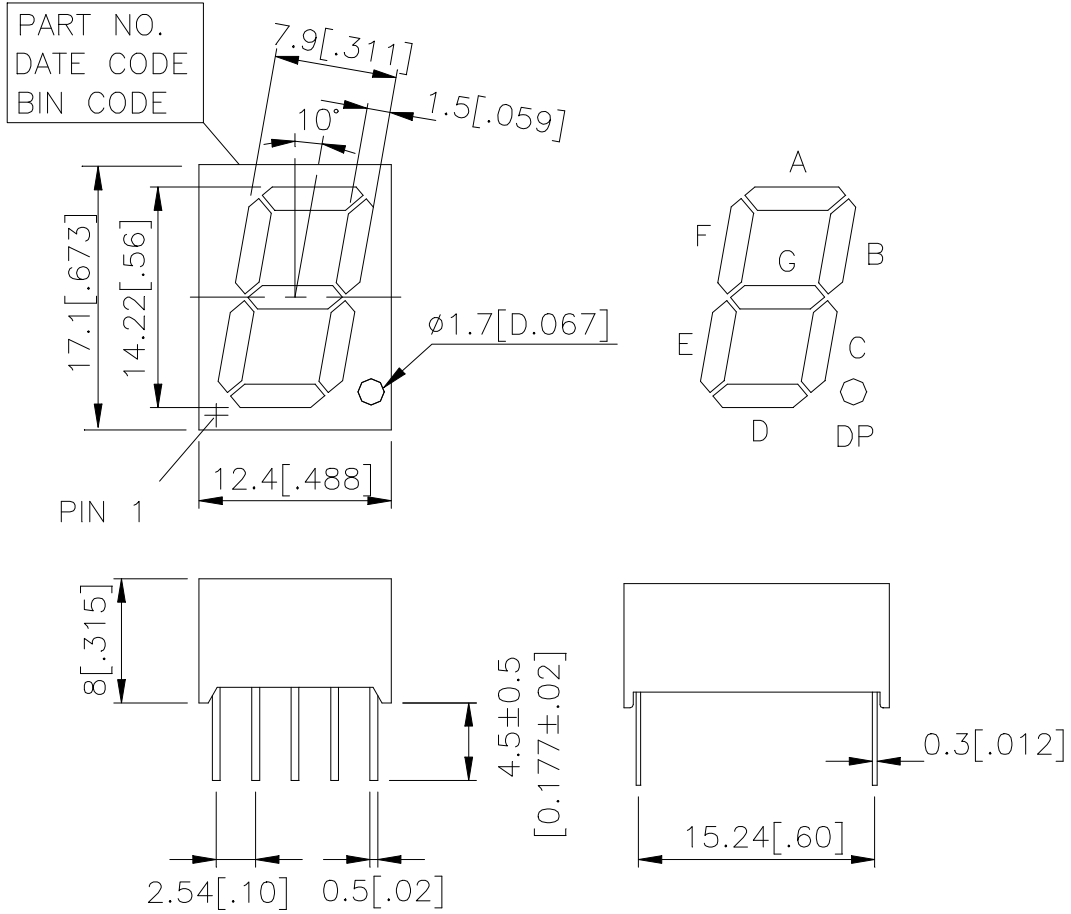

NOTES: All dimensions are in millimeters. Tolerances are $\pm 0.25\text{mm}$ (0.01") unless otherwise noted.

INTERNAL CIRCUIT DIAGRAM

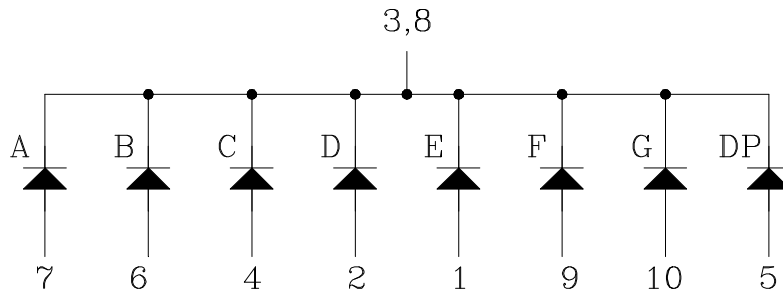

**LITE-ON TECHNOLOGY CORPORATION****Property of Lite-On Only****PIN CONNECTION**

No.	CONNECTION
1	Anode E
2	Anode D
3	Common Cathode
4	Anode C
5	Anode DP
6	Anode B
7	Anode A
8	Common Cathode
9	Anode F
10	Anode G

LITEON LITE-ON TECHNOLOGY CORPORATION

Property of Lite-On Only

ABSOLUTE MAXIMUM RATING AT Ta = 25°C

PARAMETER	MAXIMUM RATING	UNIT
Power Dissipation Per Segment	70	mW
Peak Forward Current Per Segment (Frequency 1Khz, 15% duty cycle)	90	mA
Continuous Forward Current Per Segment	25	mA
Forward Current Derating from 25°C	0.28	mA/°C
Operating Temperature Range	-35°C to +105°C	
Storage Temperature Range	-35°C to +105°C	
Soldering Conditions : 1/16 inch below seating plane for 5 seconds at 260°C		

ELECTRICAL / OPTICAL CHARACTERISTICS AT Ta = 25°C

PARAMETER	SYMBOL	MIN	TYP	MAX	UNIT	TEST CONDITION
Average Luminous Intensity Per Segment	I _v	320 5400	1300 17000		μcd	I _F = 1mA I _F = 10mA
Peak Emission Wavelength	λ _p		632		nm	I _F = 20mA
Spectral Line Half-Width	Δλ		20		nm	I _F = 20mA
Dominant Wavelength	λ _d		624		nm	I _F = 20mA
Forward Voltage Per Segment	V _F		2.1	2.6	V	I _F = 20mA
Reverse Current Per Segment	I _R			100	μA	V _R = 5V
Luminous Intensity Matching Ratio	I _v -m			2 : 1		I _F = 1mA

Note: 1.Luminous Intensity is measured with a light sensor and filter combination that approximates the CIE (Commision Internationale De L'Eclairage) eye-response curve.

2. Reverse voltage is only for IR test. It can not continue to operate at this situation.

LITEON LITE-ON TECHNOLOGY CORPORATION

Property of Lite-On Only

TYPICAL ELECTRICAL / OPTICAL CHARACTERISTIC CURVES

(25°C Ambient Temperature Unless Otherwise Noted)

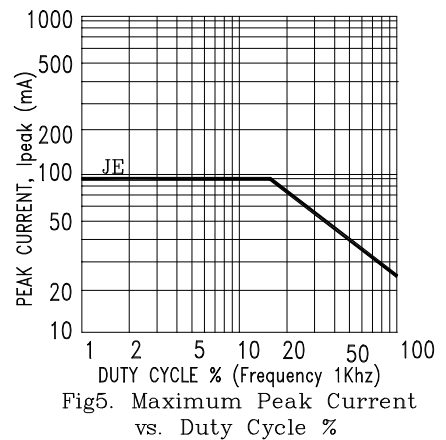
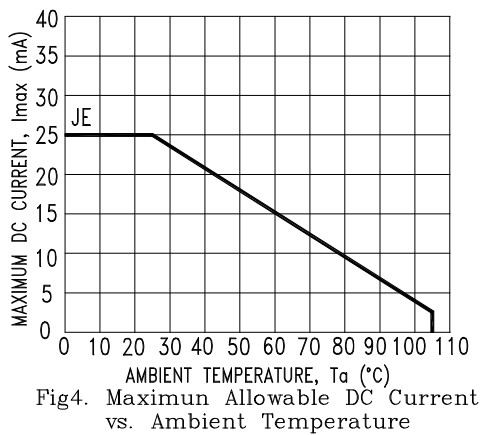
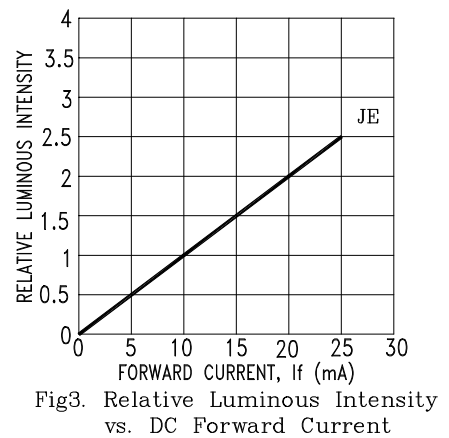
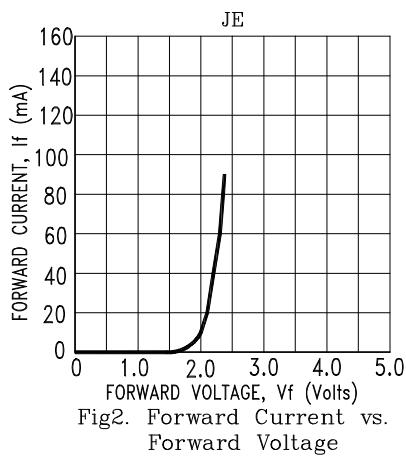
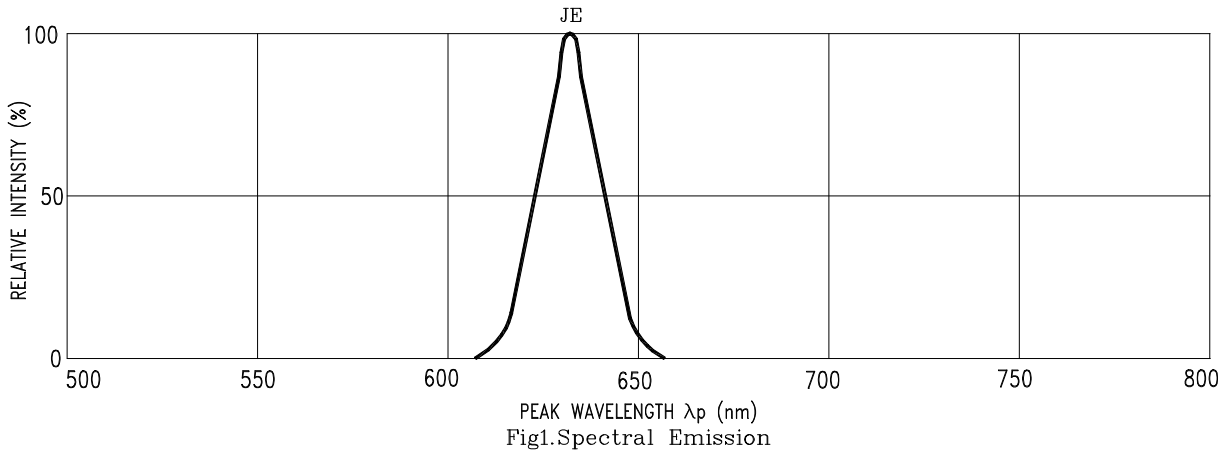

NOTE : JE=AlInGaP RED

OUR CERTIFICATE

DiGi provide top-quality products and perfect service for customer worldwide through standardization, technological innovation and continuous improvement. DiGi through third-party certification, we stricly control the quality of products and services. Welcome your RFQ to

Email: Info@DiGi-Electronics.com



Tel: +00 852-30501935

RFQ Email: Info@DiGi-Electronics.com

DiGi is a global authorized distributor of electronic components.