

KSC151GLFS Datasheet

www.digi-electronics.com

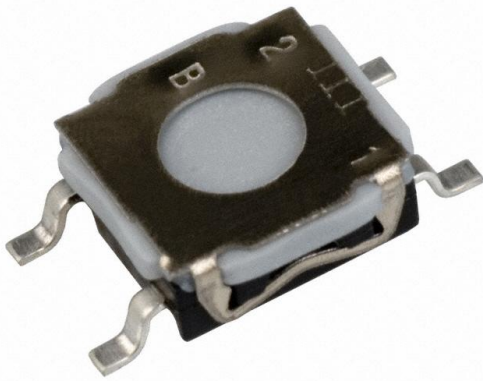

<https://www.DiGi-Electronics.com>

DiGi Electronics Part Number	KSC151GLFS-DG
Manufacturer	C&K
Manufacturer Product Number	KSC151GLFS
Description	SWITCH TACTILE SPST-NO 0.05A 32V
Detailed Description	Tactile Switch SPST-NO Top Actuated Surface Mount

This model KSC151GLFS is available at DiGi Electronics.

DiGi Electronics offers a global database of semiconductor and electronic component datasheets.

We welcome your inquiries regarding pricing, lead time, or other product-related questions.

 [Request a Quote](#)

 [Datasheet Search](#)



Tel: +00 852-30501935

RFQ Email: Info@DiGi-Electronics.com

DiGi is a global authorized distributor of electronic components.

Purchase and inquiry

Manufacturer Product Number:

KSC151GLFS

Series:

KSC

Circuit:

SPST-NO

Contact Rating @ Voltage:

0.05A @ 32VDC

Mounting Type:

Surface Mount

Actuator Length, Right Angle:

-

Termination Style:

Gull Wing

Illumination:

Non-Illuminated

Illumination Voltage (Nominal):

-

Ingress Protection:

IP67 - Dust Tight, Waterproof

Operating Temperature:

-40°C ~ 85°C

Switch Travel:

0.35mm

Base Product Number:

KSC151

Manufacturer:

C&K

Product Status:

Active

Switch Function:

Off-Mom

Actuator Type:

Without

Actuator Height off PCB, Vertical:

2.50mm

Actuator Orientation:

Top Actuated

Outline:

6.20mm x 6.20mm

Illumination Type, Color:

-

Operating Force:

550gf

Features:

-

Actuator Material:

-

Mechanical Life:

100,000 Cycles

Environmental & Export classification

RoHS Status:

ROHS3 Compliant

REACH Status:

REACH Unaffected

HTSUS:

8536.50.9031

Moisture Sensitivity Level (MSL):

1 (Unlimited)

ECCN:

EAR99

KSC1 Series

Sealed Tactile Switch for SMT 6.2 x 6.2 mm, without Actuator



Description

The KSC1 Series Sealed Tact Switch for SMT is a 2.5mm high switch, designed to give users a positive tactile feeling when used. Perfect for industrial electronics, consumer products, instrumentation or automotive applications, the KSC1 Series is IP67 rated and built to be highly responsive and long-lasting, even when used in the harshest of environments.

Features & Benefits

- Without actuator, product height 2.5 mm
- Positive tactile feeling
- IP67

Applications

- Industrial electronics
- Consumer products
- Instrumentation
- Transportation

Specifications

Packaging

Switches delivered on continuous tape & reels of 2,000 pieces
Dimensions according to EIA RS-481/ IEC 60286-3 standard
External diameter 330 ± 2 mm

Note: Specifications listed above are for switches with standard options. For information on specific and custom switches, consult Customer Service Center.

Electrical Characteristics

Dielectric Strength (50 Hz, 1 min.)	≥ 250 Vrms	
Contact Resistance	≤ 100 m Ω	
Insulation Resistance (100 V)	≥ 1000 M Ω	
Bounce Time	≤ 1 ms	
	Silver	Gold
Maximum Power	1 VA	0.2 VA
Maximum Voltage	32 VDC	32 VDC
Minimum Voltage	20 mV	20 mV
Maximum Current	50 mA	10 mA
Minimum Current	1 mA ¹	0.1 mA

Note:

1. Ultra low current with 10 μ A - 1 VDC version is available upon request

Environmental Characteristics

	Silver	Gold
Operating Temperature	-40°C to 85°C	-40°C to 125°C
Storage Temperature	-55°C to 85°C	-55°C to 125°C

Dimensions (mm)

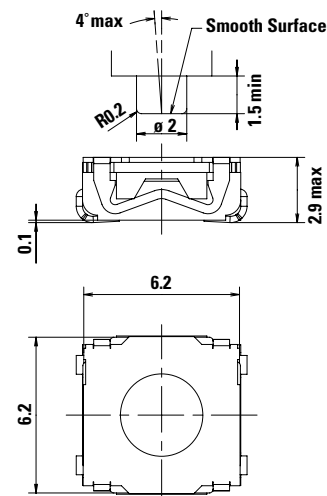

KSC1 Series

Sealed Tactile Switch for SMT 6.2 x 6.2 mm,
without Actuator



Mechanical Characteristics

Part #	Operating Force FA (Newtons)	Operating Life (operations)	Travel (mm)
KSC121	1.8 ± 0.65	200,000	0.3 ± 0.15
KSC141	3 ± 0.75		
KSC151	5.5 ± 1.4	100,000	0.35 ± 0.15

Soldering Profile

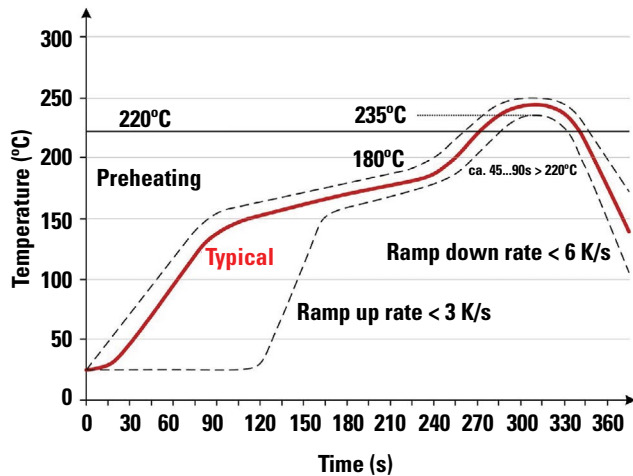

Note: Up to 2 reflow cycles in accordance with the above temperature profile

Soldering process: Depending on the application, this component is suited to the following methods:

- Terminals being silver or gold plated over a nickel barrier, the use of slightly activated flux is suitable.
- Lead free soldering process in accordance with the definition on the left.

J Terminations (mm)

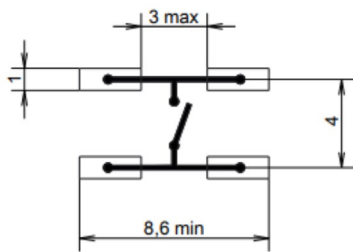

G Terminations (mm)

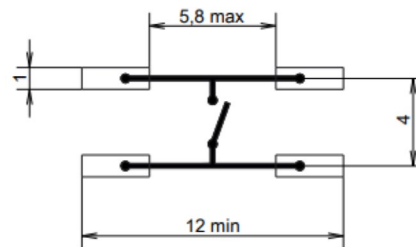

KSC1 Series

Sealed Tactile Switch for SMT 6.2 x 6.2 mm, without Actuator



Tape & Reel

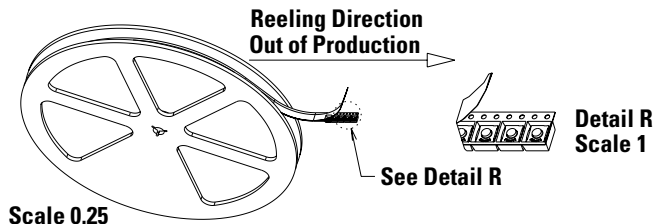

Packaging Details

Type	Tape & reel
Number of Parts in Packaging	2,000
Other Information	Tape and reel per EIA 481
Transport Conditions	According to specification NF H00-060

Ordering Number

Our easy build-a-switch concept allows you to mix and match options to create the switch you need. To order, select desired option from each category and place it in the appropriate box. However, please note that all the combinations of these options are not feasible. For any part number different from those listed above, please consult your local representative.

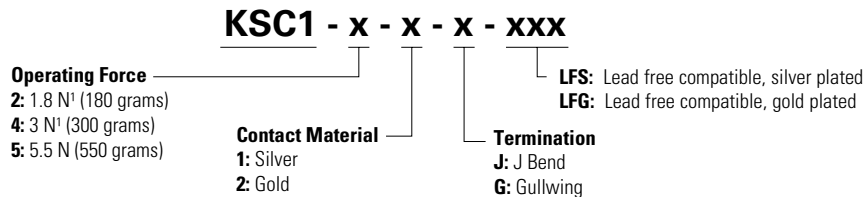

Note: See mechanical chart above to confirm specifications

Liability Limitation

This datasheet does not provide enough information for applications that require a certain level of quality or safety such as automotive, medical systems, or safety equipment. Please contact customer service for the contractual specification package.

Disclaimer Notice - Information furnished is believed to be accurate and reliable. However, users should independently evaluate the suitability of and test each product selected for their own applications. Littelfuse products are not designed for, and may not be used in, all applications. Read complete Disclaimer Notice at <http://www.littelfuse.com/disclaimer-electronics>.

OUR CERTIFICATE

DiGi provide top-quality products and perfect service for customer worldwide through standardization, technological innovation and continuous improvement. DiGi through third-party certification, we stricly control the quality of products and services. Welcome your RFQ to

Email: Info@DiGi-Electronics.com



Tel: +00 852-30501935

RFQ Email: Info@DiGi-Electronics.com

DiGi is a global authorized distributor of electronic components.