

# MP3115DT-LF-Z Datasheet

[www.digi-electronics.com](http://www.digi-electronics.com)

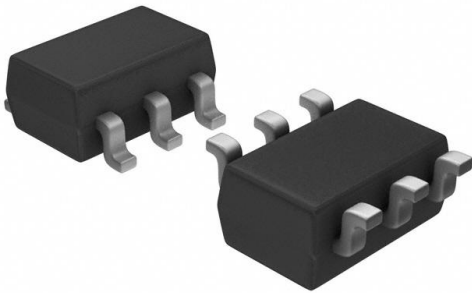

<https://www.DiGi-Electronics.com>

DiGi Electronics Part Number	MP3115DT-LF-Z-DG
Manufacturer	<a href="#">Monolithic Power Systems Inc.</a>
Manufacturer Product Number	MP3115DT-LF-Z
Description	IC REG BOOST ADJ 200MA SOT23-6
Detailed Description	Boost Switching Regulator IC Positive Adjustable 2.5V 1 Output 200mA SOT-23-6

This model MP3115DT-LF-Z is available at DiGi Electronics.

DiGi Electronics offers a global database of semiconductor and electronic component datasheets.

We welcome your inquiries regarding pricing, lead time, or other product-related questions.

 [Request a Quote](#)

 [Datasheet Search](#)



Tel: +00 852-30501935

RFQ Email: [Info@DiGi-Electronics.com](mailto:Info@DiGi-Electronics.com)

DiGi is a global authorized distributor of electronic components.

## Purchase and inquiry

Manufacturer Product Number:

MP3115DT-LF-Z

Series:

-

Function:

Step-Up

Topology:

Boost

Number of Outputs:

1

Voltage - Input (Max):

2.5V

Voltage - Output (Max):

4V

Frequency - Switching:

1.3MHz

Operating Temperature:

-40°C ~ 85°C (TA)

Package / Case:

SOT-23-6

Base Product Number:

MP3115

Manufacturer:

Monolithic Power Systems Inc.

Product Status:

Not For New Designs

Output Configuration:

Positive

Output Type:

Adjustable

Voltage - Input (Min):

0.5V

Voltage - Output (Min/Fixed):

2.5V

Current - Output:

200mA

Synchronous Rectifier:

Yes

Mounting Type:

Surface Mount

Supplier Device Package:

SOT-23-6

## Environmental & Export classification

RoHS Status:

ROHS3 Compliant

REACH Status:

REACH Unaffected

HTSUS:

8542.39.0001

Moisture Sensitivity Level (MSL):

1 (Unlimited)

ECCN:

EAR99



The Future of Analog IC Technology®

# MP3115

## High-Efficiency, Single-Cell Alkaline, 1.3MHz Synchronous Step-up Converter with Output Disconnect

**END OF LIFE, REFER TO MP3414**

### DESCRIPTION

The MP3115 is a synchronous, fixed frequency, current mode step-up converter with output-to-input disconnect optimized to boost a single AA Alkaline battery to 2.5V or 3.3V.

It can startup from an input voltage as low as 0.950V and provide in-rush current limiting as well as output short circuit protection. The integrated P-Channel synchronous rectified switch provides improved efficiency and eliminates an external schottky diode. The output disconnect feature allows the output to be completely discharged, thus allowing the part to draw less than 1 $\mu$ A of current in shutdown mode.

The 1.3MHz switching frequency allows for the use of smaller external components and the internal compensation and soft-start minimize the external component count, all helping to produce a compact solution for a wide range of load current.

The MP3115 regulates the output voltage up to 4.0V or 3.3V at 200mA from a single cell AA battery, without the use of an external Schottky diode.

The MP3115 is offered in a SOT23-6 package.

### EVALUATION BOARD REFERENCE

Board Number	Dimensions
EV3115DT-00A	L x W x H (5cm x 5cm x 1.2cm)

### FEATURES

- Over 90% Efficiency
- Output-to-Input Disconnect in Shutdown Mode
- Internal Synchronous Rectifier
- Output Voltage up to 4.0V without an External Schottky Diode
- Inrush Current Limiting and Internal Soft-Start
- Internal Compensation
- 1A Minimum Peak Current Limit
- 1.3MHz Fixed Switching Frequency
- Zero Current Shutdown Mode
- Thermal Shutdown
- 6-Pin SOT-23 Package

### APPLICATIONS

- Single-cell Alkaline Consumer Products
- MP3 Players
- Wireless Mouse
- RFTags
- Audio Recorders

"MPS" and "The Future of Analog IC Technology" are Registered Trademarks of Monolithic Power Systems, Inc.

### TYPICAL APPLICATION

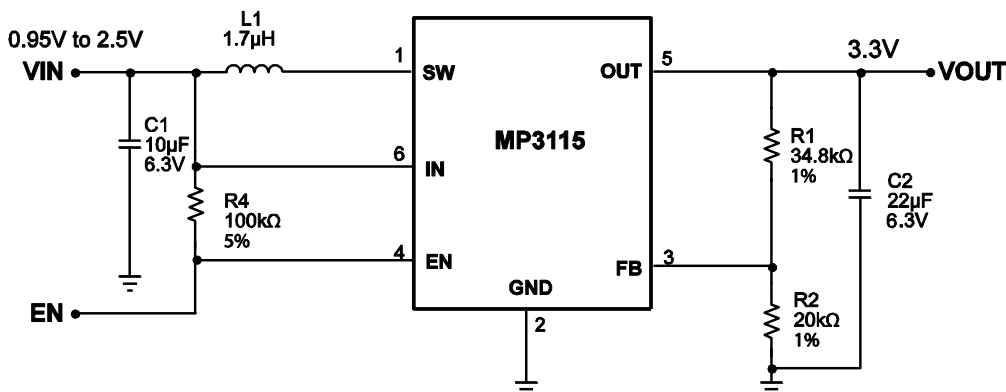

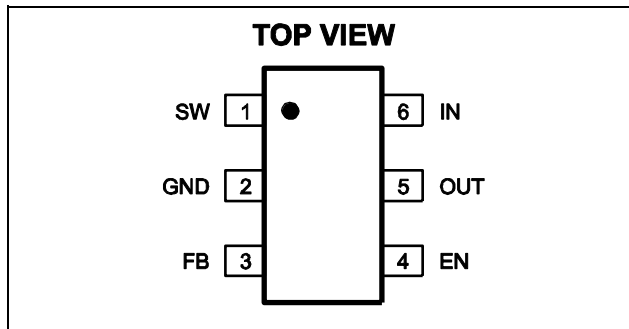
**MP3115 – HIGH-EFFICIENCY 1.3MHz SYNCHRONOUS STEP-UP CONVERTER****END OF LIFE, REFER TO MP3414****PACKAGE REFERENCE**

Part Number*	Package	Temperature
MP3115DT	SOT23-6	-40°C to +85°C

\* For Tape & Reel, add suffix -Z (eg. MP3115DT-Z)  
For RoHS Compliant Packaging, add suffix -LF  
(eg. MP3115DT-LF-Z)

**ABSOLUTE MAXIMUM RATINGS <sup>(1)</sup>**

Supply Voltage  $V_{IN}$  ..... 2.5V  
 $V_{SW}$  ..... -0.3V to 6.5V  
 All Other Pins ..... -0.3V to 6.5V  
 Storage Temperature ..... -65°C to +150°C

**Thermal Resistance <sup>(3)</sup>**     $\theta_{JA}$      $\theta_{JC}$   
 SOT23-6 ..... 195 .... 110 .. °C/W

**Notes:**

- 1) Exceeding these ratings may damage the device.
- 2) The device is not guaranteed to function outside of its operating conditions.
- 3) Measured on approximately 1" square of 1 oz copper.

**ELECTRICAL CHARACTERISTICS**

$V_{IN} = 1.5V$ ,  $V_{EN} = V_{OUT} = 3.3V$ ,  $T_A = +25^\circ C$ , unless otherwise noted.

Parameter	Symbol	Condition	Min	Typ	Max	Units
Minimum Startup Voltage	$V_{ST}$	$R_L = 3k\Omega$ , Rising Edge		0.95	1.1	V
Minimum Operating Voltage <sup>(4)</sup>	$V_{IN}$	$V_{EN} = V_{IN}$			0.5	V
Output Voltage Range	$V_{OUT}$		2.5		4.0	V
Supply Current (Shutdown)		$V_{EN} = V_{OUT} = 0V$		0	1	$\mu A$
Supply Current (Quiescent)		$V_{FB} = 1.3V$		200		$\mu A$
Feedback Voltage	$V_{FB}$			1.225		V
Feedback Input Current		$V_{FB} = 1.2V$		10		nA
Switching Frequency	$f_{SW}$	$V_{FB} = 1.1V$		1.3		MHz
Maximum Duty Cycle	$D_{MAX}$	$V_{FB} = 1.1V$	85	90		%
EN Input Low Voltage					0.4	V
EN Input High Voltage			0.9			V
EN Input Current		$V_{EN} = 3V$		0	1	$\mu A$
NMOS On Resistance	$R_{NMOS}$			300		m $\Omega$
NMOS Leakage Current		$V_{SW} = 5.5V$		1		$\mu A$
NMOS Current Limit	$I_{LIM}$		1	1.3		A
PMOS On Resistance	$R_{PMOS}$			600		m $\Omega$
PMOS Leakage Current		$V_{EN} = V_{OUT} = 0V$ , $V_{SW} = 3V$		1		$\mu A$
Thermal Shutdown <sup>(5)</sup>				160		°C
Thermal Shutdown Hysteresis <sup>(5)</sup>				30		°C
Minimum On Time <sup>(5)</sup>				100	150	ns

**Notes:**

- 4) The MP3115 is not dependent on  $V_{IN}$  when  $V_{OUT}$  is greater than 2.4V.
- 5) Guaranteed by design, not tested.

**END OF LIFE, REFER TO MP3414****PIN FUNCTIONS**

Pin #	Name	Description
1	SW	Output Switch Node. SW is the drain of the internal N-Channel and P-Channel MOSFETs. Connect the inductor to SW to complete the step-up converter.
2	GND	Ground.
3	FB	Regulation Feedback Input. Connect an external resistive voltage divider from the output to FB to set the output voltage.
4	EN	Regulator On/Off Control Input. A logic high input ( $V_{EN} > 0.9V$ ) turns on the regulator. A logic low input ( $V_{EN} < 0.4V$ ) puts the MP3115 into low current shutdown mode.
5	OUT	Supply Input for the MP3115 and Output Voltage Sense Input. Connect to the output of the converter.
6	IN	Input Voltage.



**MP3115 – HIGH-EFFICIENCY 1.3MHz SYNCHRONOUS STEP-UP CONVERTER**

**END OF LIFE, REFER TO MP3414**

**TYPICAL PERFORMANCE CHARACTERISTICS**

C1 = 10µF, C2=22µF, L=1.7µH,R2=20K, T<sub>A</sub> = +25°C, unless otherwise noted.

**Efficiency vs. Load Current**

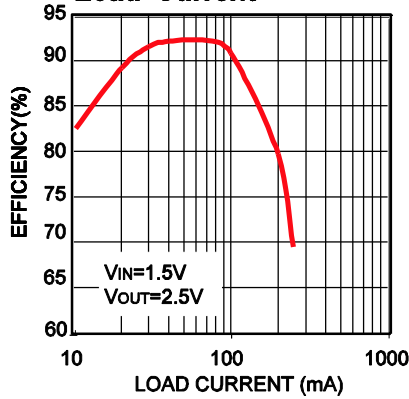

**Efficiency vs. Load Current**

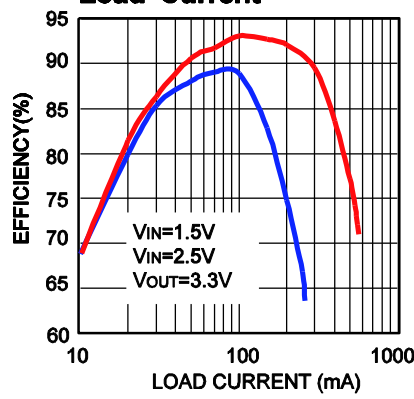

**Load Regulation**

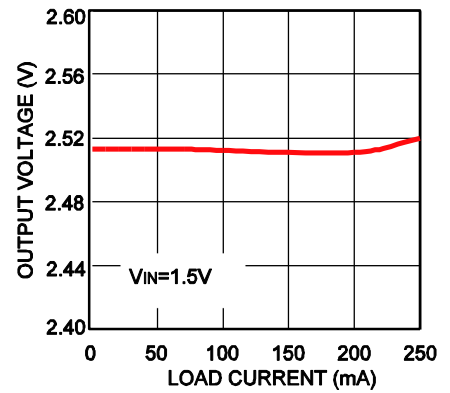

**Line Regulation**

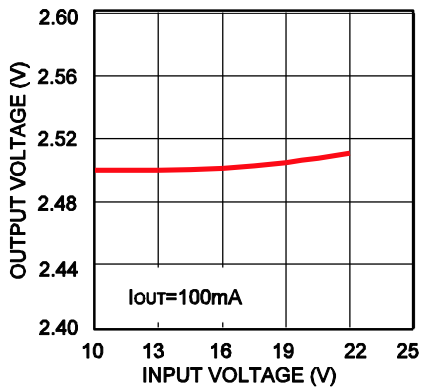

**Minimum Start VIN vs. IOUT**

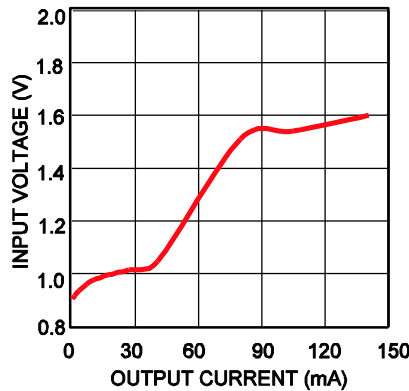

**IPEAK vs. Duty Cycle**

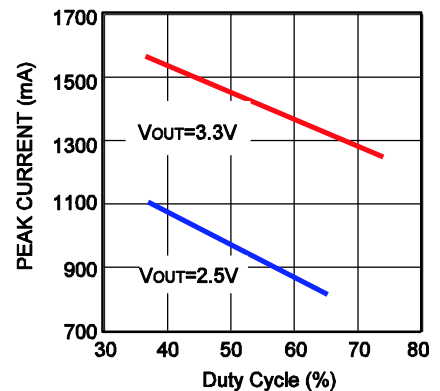

**Line Transient**

V<sub>IN</sub>=1.2V to 2V, V<sub>OUT</sub>=2.5V, I<sub>OUT</sub>=48mA  
V<sub>EN</sub>=V<sub>IN</sub>, Resistor Load

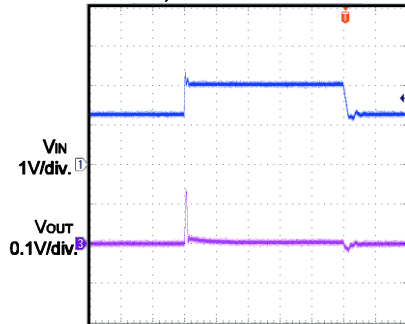

200µs/div.

**Load Transient**

V<sub>IN</sub>=1.2V, V<sub>OUT</sub>=2.5V, I<sub>OUT</sub>=0mA to 50mA  
V<sub>EN</sub>=V<sub>IN</sub>, Resistor Load

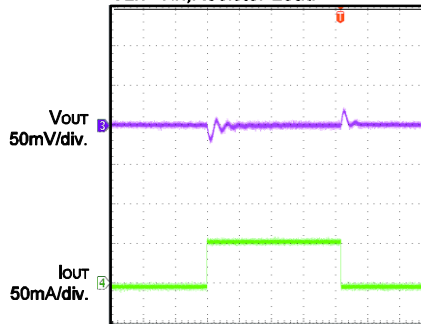

40µs/div.

**Inrush Current**

V<sub>EN</sub>=2V, V<sub>IN</sub>=1.5V, V<sub>OUT</sub>=3.3V  
I<sub>OUT</sub>=41mA, C<sub>FF</sub>=10nF

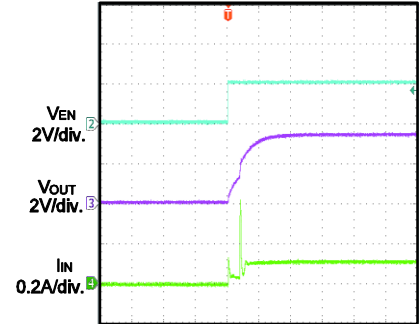

1ms/div.



END OF LIFE, REFER TO MP3414

## TYPICAL PERFORMANCE CHARACTERISTICS (continued)

C1 = 10 $\mu$ F, C2=22 $\mu$ F, L=1.7 $\mu$ H, R2=20K, T<sub>A</sub> = +25°C, unless otherwise noted.

## Enable Turn On vs. Outputs

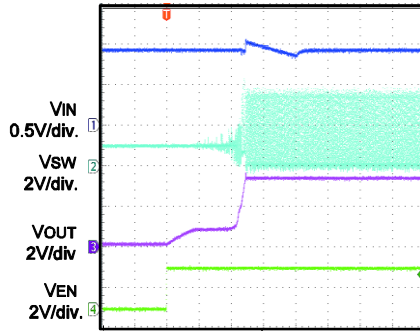
VIN=0.93V, VOUT=3.3V  
VEN=2V, Load with 3k $\Omega$  Resistor

1ms/div

## Enable Turn Off vs. Outputs

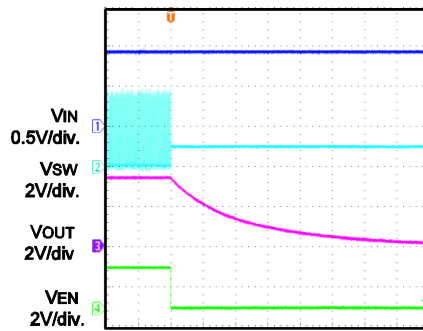
VIN=0.93V, VOUT=3.3V  
VEN=2V, Load with 3k $\Omega$  Resistor

10ms/div

## VIN Rump Up

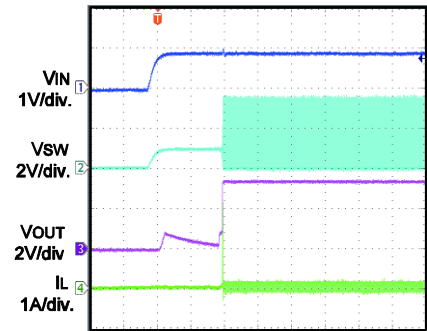
VIN=VEN=0.93V, VOUT=3.3V  
Load with 3k $\Omega$  Resistor

20ms/div.

## Short Circuit

VIN=VEN=2V, VOUT=3.3V

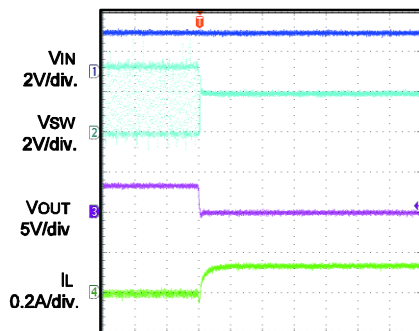
20 $\mu$ s/div

## Short Circuit Recovery

VIN=VEN=2V, VOUT=3.3V

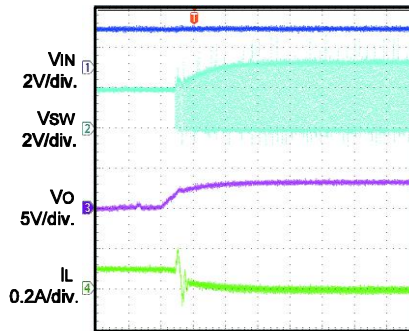
200 $\mu$ s/div

## VIN Rump Down

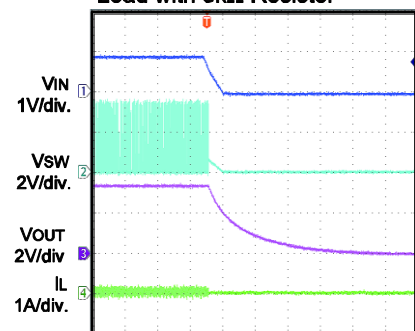
VIN=VEN=0.93V, VOUT=3.3V  
Load with 3k $\Omega$  Resistor

20ms/div.

## No Load Ripple

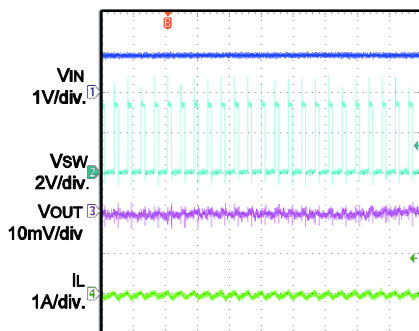
VIN=VEN=0.92V, VOUT=3.3V  
I<sub>OUT</sub>=0mA2 $\mu$ s/div

## Full Load Ripple

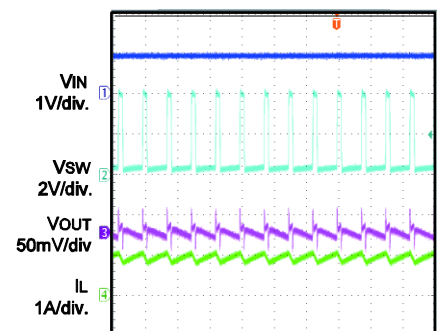
VIN=VEN=0.95V, VOUT=3.3V  
I<sub>OUT</sub>=150mA1 $\mu$ s/div



## OPERATION

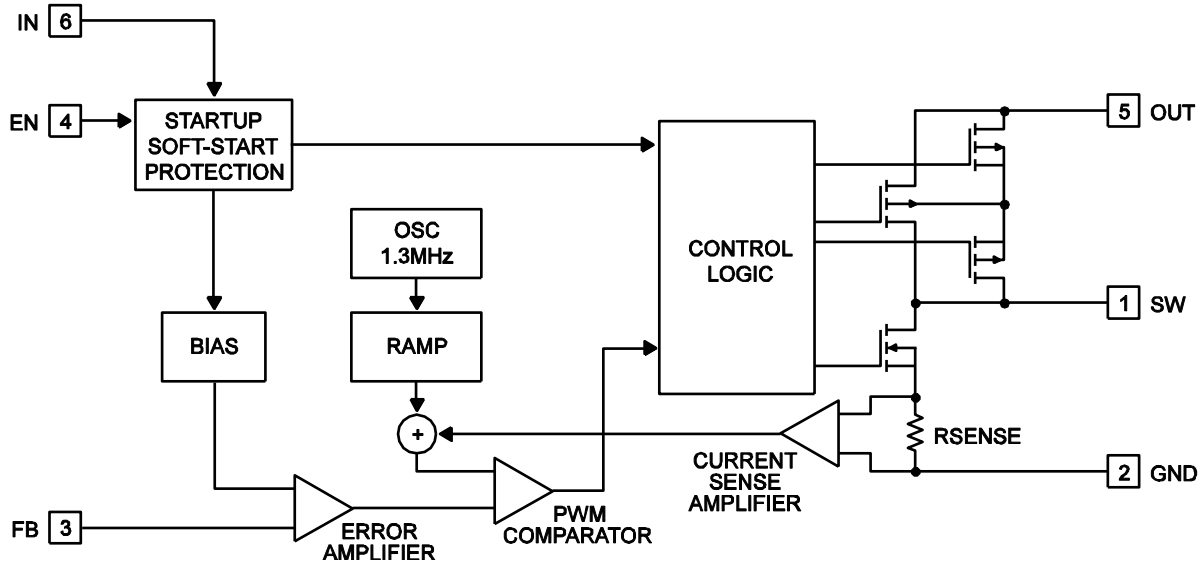

Figure 1—Functional Block Diagram

The MP3115 uses a 1.3MHz fixed-frequency, current-mode regulation architecture to regulate the output voltage. The MP3115 measures the output voltage through an external resistive voltage divider and compares that to the internal 1.2V reference to generate the error voltage. The current-mode regulator compares the error voltage to the inductor current to regulate the output voltage. The use of current-mode regulation improves transient response and control loop stability.

When the MP3115 is disabled ( $EN < 0.4V$ ), both power switches are off. The body of the P-Channel MOSFET connects to SW thus there is no current path from SW to OUT. When the MP3115 is enabled ( $EN > 0.8V$ ), the P-Channel MOSFET turns on to charge the output capacitor to a voltage close to the input voltage. During this time, the gate of the P-Channel is controlled to limit the chip power dissipation. The MP3115 starts switching when the output voltage is close to the input voltage. If the input voltage is less than 1.6V, the MP3115 will start with CCM (constant current mode) until the output voltage crosses 1.6V. After that, the soft-start circuit will take over to bring the output voltage to the regulated value.

At the beginning of each cycle, the N-channel MOSFET switch is turned on, forcing the inductor current to rise. The current at the source of the switch is internally measured and converted to a voltage by the current sense amplifier. That voltage is compared to the error voltage. When the inductor current rises sufficiently, the PWM comparator turns off the switch, forcing the inductor current to the output capacitor through the internal P-Channel MOSFET rectifier, which forces the inductor current to decrease. The peak inductor current is controlled by the error voltage, which in turn is controlled by the output voltage. Thus the output voltage controls the inductor current to satisfy the load.

The MP3115 has a temperature sensing circuit to protect the part. The MP3115 turns off both switches when the chip temperature reaches 150°C.



## APPLICATION INFORMATION

### COMPONENT SELECTION

#### Setting the Output Voltage

Set the output voltage by selecting the resistive voltage divider ratio. The voltage divider drops the output voltage to the 1.2V feedback voltage. Use 20kΩ for the low-side resistor (R2) of the voltage divider. Determine the high-side resistor (R1) by the equation:

$$R1 = \frac{V_{OUT} - V_{FB}}{\left(\frac{V_{FB}}{R2}\right)}$$

Where  $V_{OUT}$  is the output voltage,  $V_{FB}$  is the 1.2V feedback voltage and  $R2=20k\Omega$ .

#### Selecting the Input Capacitor

An input capacitor is required to supply the AC ripple current to the inductor while limiting noise at the input source. Multi-layer ceramic capacitors are recommended as they have extremely low ESR and are available in small footprints. Use an input capacitor of 4.7μF or greater, and place it physically close to the device.

#### Selecting the Output Capacitor

A single 4.7μF to 10μF ceramic capacitor normally provides sufficient output capacitance for most applications. Larger values (up to 22μF) may be used to obtain extremely low output voltage ripple and improve transient response. The impedance of the ceramic capacitor at the switching frequency is dominated by its capacitance, so the output voltage ripple is mostly independent of ESR. The output voltage ripple  $V_{RIPPLE}$  is calculated as:

$$V_{RIPPLE} = \frac{I_{LOAD}(V_{OUT} - V_{IN})}{V_{OUT} \times C2 \times f_{SW}}$$

Where  $V_{IN}$  is the input voltage,  $I_{LOAD}$  is the load current,  $C2$  is the capacitance of the output capacitor and  $f_{SW}$  is the 1.3MHz switching frequency.

#### Selecting the Inductor

The inductor is required to force the output voltage higher while being driven by the lower input voltage. A good rule for determining the inductance is to allow the peak-to-peak ripple current to be approximately 30%-50% of the maximum input current. Make sure that the peak inductor current is below the minimum current limit at the duty cycle used to prevent loss of regulation due to current limit variation.

Calculate the required inductance value L using the equations:

$$L = \frac{V_{IN}(V_{OUT} - V_{IN})}{V_{OUT} \times f_{SW} \times \Delta I}$$

$$I_{IN(MAX)} = \frac{V_{OUT} \times I_{LOAD(MAX)}}{V_{IN} \times \eta}$$

$$\Delta I = (30\% - 50\%)I_{IN(MAX)}$$

Where  $I_{LOAD(MAX)}$  is the maximum load current,  $\Delta I$  is the peak-to-peak inductor ripple current and  $\eta$  is the efficiency. For the MP3115, 4.7μH is recommended for most applications. Choose an inductor that does not saturate at the peak switch current as calculated above with additional margin to cover for heavy load transients and extreme startup conditions.

#### Selecting the Feed-Forward Capacitor

A feed-forward capacitor in parallel with the high-side resistor R1 can be added to improve the output ripple at both discontinuous conduction modes and the load transient response. A 47pF capacitor is recommended for most applications.

### LAYOUT CONSIDERATIONS

High frequency switching regulators require very careful layout for stable operation and low noise. All components must be placed as close to the IC as possible. All feedback components must be kept close to the FB pin to prevent noise injection on the FB pin trace. The ground return of C1 and C2 should be tied close to the GND pin. See the MP3115 demo board layout for reference.



END OF LIFE, REFER TO MP3414

## PACKAGE INFORMATION

## SOT23-6

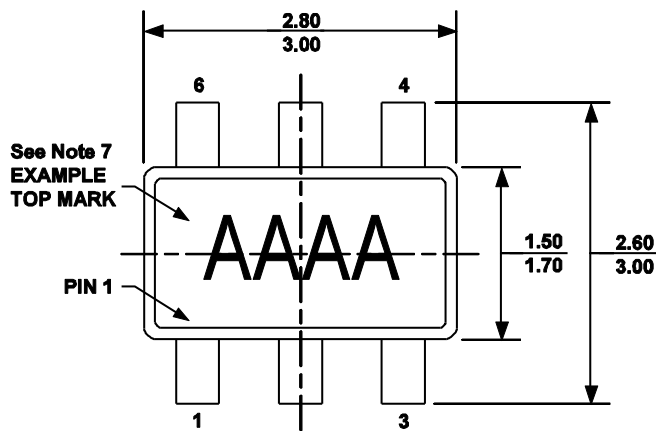
**PACKAGE OUTLINE DRAWING FOR 6-SOT23**  
**MF-PO-D-0032 revision 2.1**

TOP VIEW

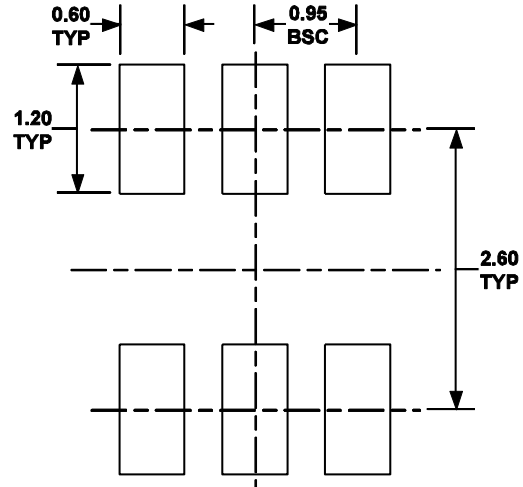

RECOMMENDED LAND PATTERN

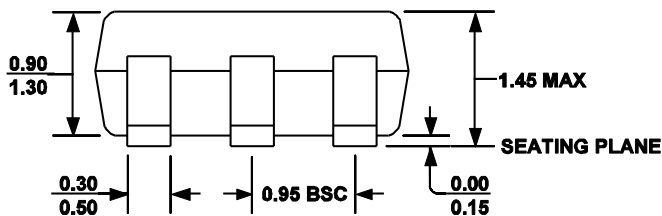

FRONT VIEW

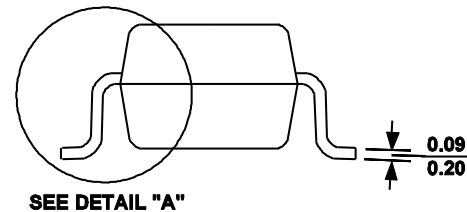

SIDE VIEW

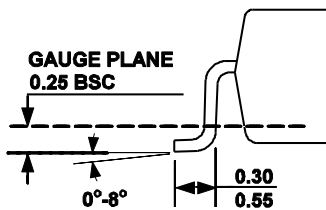

DETAIL "A"

**NOTE:**

- 1) ALL DIMENSIONS ARE IN MILLIMETERS.
- 2) PACKAGE LENGTH DOES NOT INCLUDE MOLD FLASH, PROTRUSION OR GATE BURR.
- 3) PACKAGE WIDTH DOES NOT INCLUDE INTERLEAD FLASH OR PROTRUSION.
- 4) LEAD COPLANARITY (BOTTOM OF LEADS AFTER FORMING) SHALL BE 0.10 MILLIMETERS MAX.
- 5) DRAWING CONFORMS TO JEDEC MO-178, VARIATION AB.
- 6) DRAWING IS NOT TO SCALE.
- 7) PIN 1 IS LOWER LEFT PIN WHEN READING TOP MARK FROM LEFT TO RIGHT, (SEE EXAMPLE TOP MARK)

**NOTICE:** The information in this document is subject to change without notice. Users should warrant and guarantee that third party Intellectual Property rights are not infringed upon when integrating MPS products into any application. MPS will not assume any legal responsibility for any said applications.

## OUR CERTIFICATE

DiGi provide top-quality products and perfect service for customer worldwide through standardization, technological innovation and continuous improvement. DiGi through third-party certification, we stricly control the quality of products and services. Welcome your RFQ to

Email: [Info@DiGi-Electronics.com](mailto:Info@DiGi-Electronics.com)



Tel: +00 852-30501935

RFQ Email: [Info@DiGi-Electronics.com](mailto:Info@DiGi-Electronics.com)

DiGi is a global authorized distributor of electronic components.