

MP5418GQG-P Datasheet



<https://www.DiGi-Electronics.com>

DiGi Electronics Part Number	MP5418GQG-P-DG
Manufacturer	Monolithic Power Systems Inc.
Manufacturer Product Number	MP5418GQG-P
Description	200MA, 2.3-5V, NEGATIVE CHARGE P
Detailed Description	PMIC - Voltage Regulators - Linear Switching 2 Output Charge Pump (1), Linear (LDO) (1) 30kHz ~ 550kHz 10-UTQFN (1.4x1.8)



Tel: +00 852-30501935

RFQ Email: Info@DiGi-Electronics.com

DiGi is a global authorized distributor of electronic components.

Purchase and inquiry

Manufacturer Product Number:

MP5418GQG-P

Series:

MP

Topology:

Charge Pump (1), Linear (LDO) (1)

Frequency - Switching:

30kHz ~ 550kHz

Voltage/Current - Output 2:

0V ~ -5V, 200mA

w/Supervisor:

No

Voltage - Supply:

2.3V ~ 5V

Mounting Type:

Surface Mount

Supplier Device Package:

10-UTQFN (1.4x1.8)

Manufacturer:

Monolithic Power Systems Inc.

Product Status:

Active

Number of Outputs:

2

Voltage/Current - Output 1:

-2.3V ~ -5V, 200mA

w/LED Driver:

No

w/Sequencer:

No

Operating Temperature:

-40°C ~ 125°C (TJ)

Package / Case:

10-UFQFN

Environmental & Export classification

RoHS Status:

ROHS3 Compliant

REACH Status:

REACH Unaffected

HTSUS:

8542.39.0001

Moisture Sensitivity Level (MSL):

1 (Unlimited)

ECCN:

EAR99



MP5418

Negative Charge Pump and Adjustable Regulator

DESCRIPTION

The MP5418 is a monolithic negative charge pump with a built-in adjustable negative regulator. It has an input range from 2.3V to 5V and provides an unregulated output equal to the negative input voltage. The MP5418 also provides a regulated output between 0V and the negative input voltage.

No external inductor is required, which reduces space and simplifies design. An internal soft-start circuit effectively reduces the in-rush current during start-up.

The MP5418 is available in an ultra-low profile QFN-10 1.4mmx1.8mm package. It requires only 4 ceramic capacitors for a compact solution size. It is ideal for a wide range of applications, including optical modules, RF amplifiers, and sensor supplies.

FEATURES

- Low I_Q : 220 μ A
- V_{IN} Range from 2.3V to 5V
- Up to 200mA Output Current
- Only 4 x 4.7 μ F Capacitors Needed for 60mA
- Auto Power-Save Mode
- EN Control
- No Inrush Current during Start-Up
- Short-Current Protection
- Dual Output:
 1. -1x Charge Pump
 2. Regulated output between 0V and $-V_{IN}$
- Small Space Saving QFN-10 1.4mmx1.8mm Package

APPLICATIONS

- Optical Module
- Bias for RF amplifier
- Sensor Supply in Portable Instruments

All MPS parts are lead-free, halogen free, and adhere to the RoHS directive. For MPS green status, please visit MPS website under Quality Assurance. "MPS" and "The Future of Analog IC Technology" are Registered Trademarks of Monolithic Power Systems, Inc.

TYPICAL APPLICATION

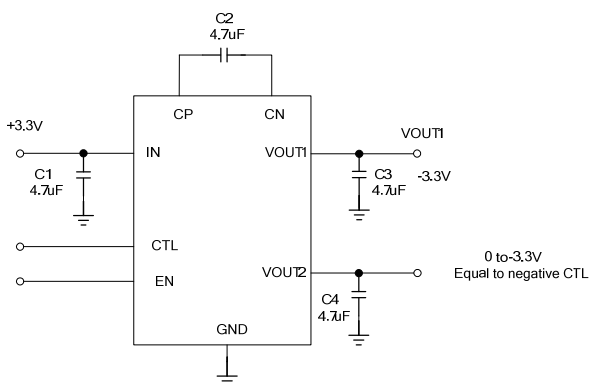

Steady State

$V_{IN}=3.3V$, $CTL=1V$, $I_{OUT1}=0A$, $I_{OUT2}=20mA$

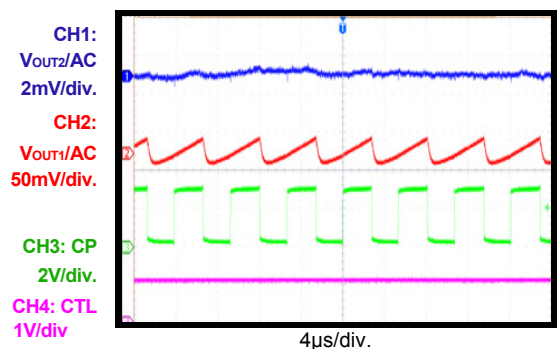



MP5418 – NEGATIVE CHARGE PUMP AND ADJUSTABLE REGULATOR

ORDERING INFORMATION

Part Number*	Package	Top Marking
MP5418GQG	QFN-10(1.4mmx1.8mm)	See Below

* For Tape & Reel, add suffix -Z (e.g. MP5418GQG-Z).

TOP MARKING

—
HC

LL

HC: Product code of MP5418GQG
LL: Lot number

PACKAGE REFERENCE

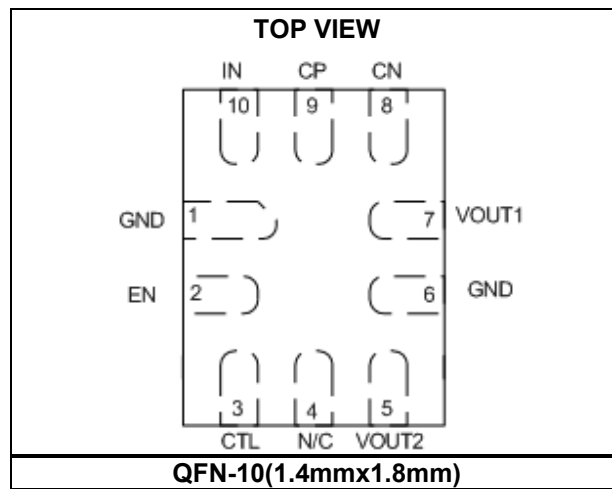



MP5418 – NEGATIVE CHARGE PUMP AND ADJUSTABLE REGULATOR

PIN FUNCTIONS

Pin #	Name	Description
1	GND	Power ground.
2	EN	On/off control.
3	CTL	Analog input voltage. The V_{OUT2} voltage will be -1x the CTL pin voltage.
4	N/C	Recommend connecting to ground.
5	VOUT2	Negative linear regulator output. A decoupling capacitor is needed.
6	GND	Power ground.
7	VOUT1	Negative charge pump output. A decouple capacitor is needed.
8	CN	Negative terminal of fly capacitor.
9	CP	Positive terminal of fly capacitor.
10	IN	Supply voltage. The MP5418 operates from a +2.3V to +5V unregulated input. A decoupling capacitor is needed to prevent large voltage spikes from appearing at the input.

ABSOLUTE MAXIMUM RATINGS ⁽¹⁾

Supply Voltage (V_{IN}).....	-0.3V to 6V
V_{CP}	-0.3V to $V_{IN}+0.3V$
V_{CN}	$V_{OUT}-0.3V$ to 0.3V
V_{OUT1}	-6V to 0.3V
V_{OUT2}	V_{OUT1} to 0.3V
All Other Pins	-0.3V to 6V
Junction Temperature.....	150°C
Lead Temperature	260°C
Continuous Power Dissipation ($T_A = +25^\circ C$) (2)(4)	1.47W
Storage Temperature.....	-65°C to +150°C

Recommended Operating Conditions ⁽³⁾

Supply Voltage (V_{IN}).....	2.3V to 5V
Operating Junction Temp. (T_J).....	-40°C to +125°C

Thermal Resistance	θ_{JA}	θ_{JC}
QFN-10(1.4mmx1.8mm)		
EV5418-G-00B ⁽⁴⁾	85	45 °C/W
JESD51-7 ⁽⁵⁾	140	30 °C/W

Notes:

- Exceeding these ratings may damage the device.
- The maximum allowable power dissipation is a function of the maximum junction temperature T_J (MAX), the junction-to-ambient thermal resistance θ_{JA} , and the ambient temperature T_A . The maximum allowable continuous power dissipation at any ambient temperature is calculated by P_D (MAX) = $(T_J$ (MAX)- T_A)/ θ_{JA} . Exceeding the maximum allowable power dissipation will cause excessive die temperature, and the regulator will go into thermal shutdown. Internal thermal shutdown circuitry protects the device from permanent damage.
- The device is not guaranteed to function outside of its operating conditions.
- Measured on EV5418-G-00B, 2-layer 63mmx63mm PCB.
- The value of θ_{JA} given in this table is only valid for comparison with other packages and cannot be used for design purposes. These values were calculated in accordance with JESD51-7, and simulated on a specified JEDEC board. They do not represent the performance obtained in an actual application.

MP5418 – NEGATIVE CHARGE PUMP AND ADJUSTABLE REGULATOR
ELECTRICAL CHARACTERISTICS
 $V_{IN} = 3.3V$, $T_J = -40^{\circ}C$ to $+125^{\circ}C$ ⁽⁶⁾, Typical value is tested at $T_J = +25^{\circ}C$, unless otherwise noted.

Parameter	Symbol	Condition	Min	Typ	Max	Units
V_{IN} range			2.3		5	V
Under-voltage lockout threshold rising				2.2	2.3	V
Under-voltage lockout threshold hysteresis			100	180	260	mV
Supply current (shutdown)		$V_{EN}=0V$		1.5	3	μA
Supply current (quiescent)		$V_{EN}=2V$, no load, $T_J = +25^{\circ}C$		220	260	μA
		$V_{EN}=2V$, no load, $T_J > -40^{\circ}C$ & $T_J < +125^{\circ}C$			360	μA
Charge pump frequency		Detect V_{IN} & V_{OUT1} , $T_J = +25^{\circ}C$	30		550	kHz
Charge pump MOS RON	R_{ON}			0.24		Ω
Charge pump current limit			0.6	1		A
Negative Linear Regulator						
Load current limit ⁽⁷⁾		$V_{IN}=3.3V$, $V_{OUT2}=-2.5V$		200	250	mA
Output accuracy		Compared with CTL voltage, room temp, $I_{OUT2}=10mA$	-1		1	%
		Over temp, $I_{OUT2}=10mA$	-2		2	%
Output offset		$I_{OUT2}=10mA$	-20		20	mV
Dropout voltage	V_{DROP}	$V_{IN}=2.5V$, $I_{OUT2}=60mA$	30		90	mV
		$V_{IN}=3.3V$, $I_{OUT2}=60mA$	20		80	mV
Load regulation ⁽⁷⁾		$V_{OUT1}=-3.3V$, CTL=1V		0.005	0.01	%/mA
PSRR ⁽⁷⁾		100Hz, $C_{OUT1}=100pF$, $C_{OUT2}=1\mu F$, $I_{OUT2}=10mA$		60		dB
		50kHz, $C_{OUT1}=100pF$, $C_{OUT2}=1\mu F$, $I_{OUT2}=10mA$		50		
		300kHz, $C_{OUT1}=100pF$, $C_{OUT2}=1\mu F$, $I_{OUT2}=10mA$		40		
Soft-start slew-rate				5		V/ms
EN turn-on delay			135		285	μs
EN input logic low voltage					0.4	V
EN input logic high voltage			1.2			V
Output discharge resistor	R_{DIS1}	$V_{EN}=0V$, V_{OUT1} rail	170		310	Ω
	R_{DIS2}	$V_{EN}=0V$, V_{OUT2} rail	80		146	Ω
EN input current		$V_{EN}=2V$	1.4	1.8	2.2	μA
		$V_{EN}=0V$		0		μA
Thermal shutdown ⁽⁷⁾				160		$^{\circ}C$
Thermal hysteresis ⁽⁷⁾				30		$^{\circ}C$



MP5418 – NEGATIVE CHARGE PUMP AND ADJUSTABLE REGULATOR

ELECTRICAL CHARACTERISTICS *(continued)*

$V_{IN} = 3.3V$, $T_J = -40^{\circ}C$ to $+125^{\circ}C$ ⁽⁶⁾, Typical value is tested at $T_J = +25^{\circ}C$, unless otherwise noted.

Parameter	Symbol	Condition	Min	Typ	Max	Units
System Level⁽⁷⁾						
Recommended input capacitance	C_{IN}	$V_{IN}=3.3V$		4.7		μF
Recommended fly capacitor	C_{Fly}			4.7		μF
Recommended V_{OUT1} capacitor				4.7		μF
Recommended V_{OUT2} capacitor				4.7		μF
V_{OUT1} voltage				-1x		V_{IN}
Output ripple	V_{Ripple_OUT1}	$V_{IN}=3.3V$, $V_{OUT1}=-3.3V$, $C_{FLY}=C_{OUT1}=4.7\mu F$, $I_{OUT1}=60mA$		50		mV
	V_{Ripple_OUT2}	$V_{IN}=3.3V$, $V_{OUT2}=2.5V$, $C_{OUT2}=1\mu F$, $I_{OUT2}=60mA$		1		mV

Notes:

- 6) Guaranteed by over-temperature correlation, not tested in production.
7) Guaranteed by engineer sample characterization.



MP5418 – NEGATIVE CHARGE PUMP AND ADJUSTABLE REGULATOR

TYPICAL PERFORMANCE CHARACTERISTICS

$V_{IN} = 3.3V$, $V_{OUT1} = -3.3V$, $V_{OUT2} = -1V$, $C_{IN} = C_{FLY} = C_{OUT1} = C_{OUT2} = 4.7\mu F$, $T_A = +25^\circ C$, unless otherwise noted.

Load Capability
CTL=2.5V

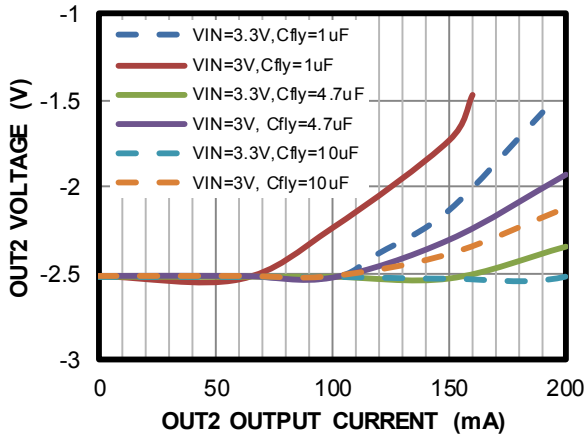

Negative Linear Regulator Load Regulation
VIN=3.3V, CTL=1V

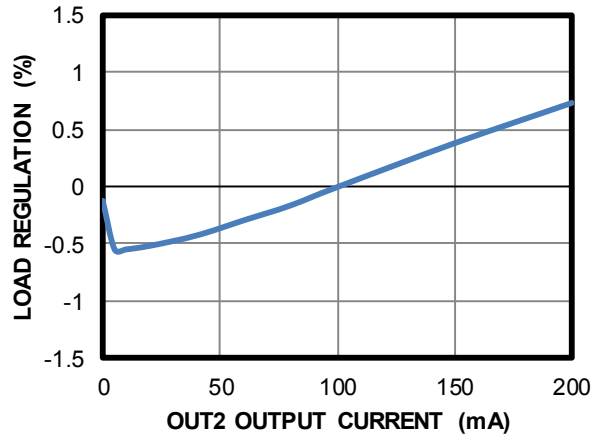

Quiescent Current vs. VIN

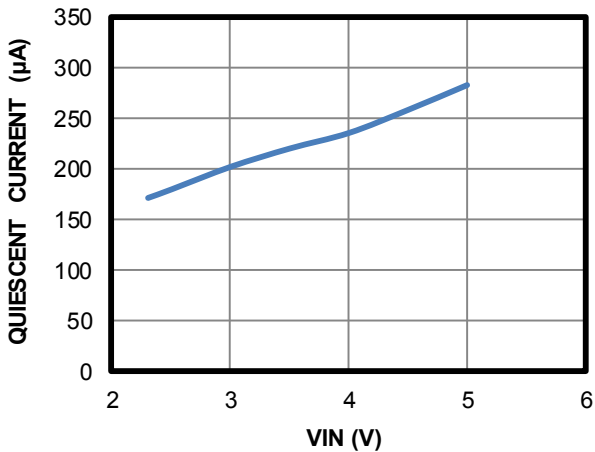

Frequency vs. Output Current

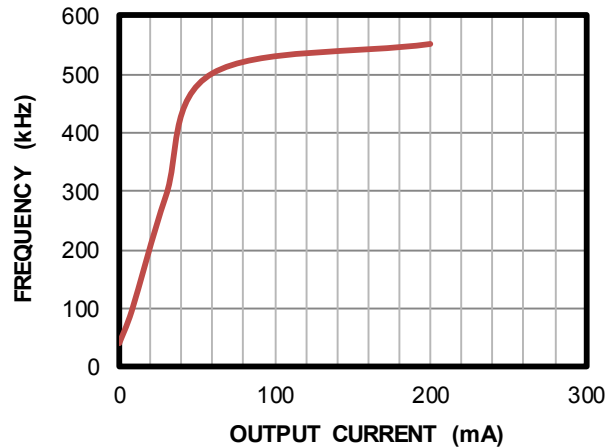

VIN Rising Threshold vs. Temperature

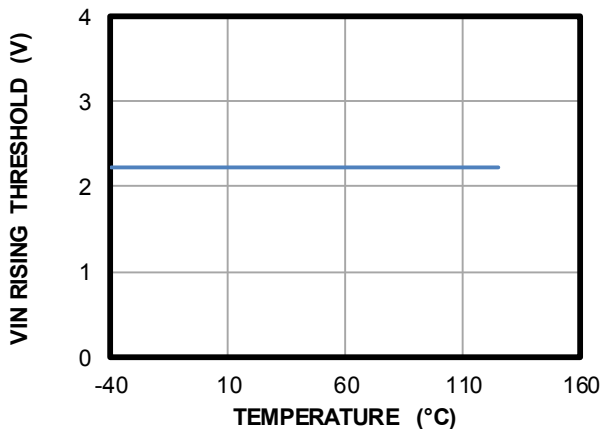

UVLO Hysteresis vs. Temperature

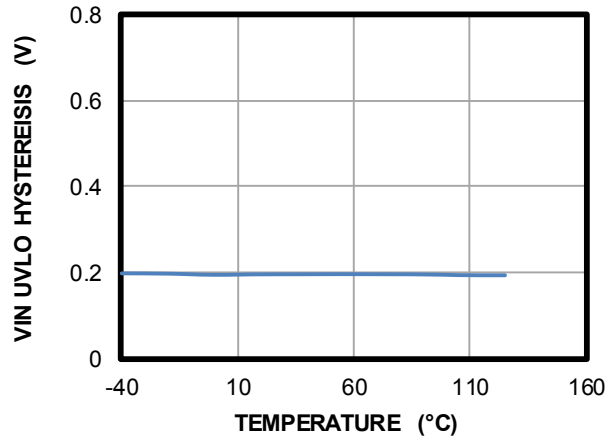



MP5418 – NEGATIVE CHARGE PUMP AND ADJUSTABLE REGULATOR

TYPICAL PERFORMANCE CHARACTERISTICS (continued)

$V_{IN} = 3.3V$, $V_{OUT1} = -3.3V$, $V_{OUT2} = -1V$, $C_{IN} = C_{FLY} = C_{OUT1} = C_{OUT2} = 4.7\mu F$, $T_A = +25^\circ C$, unless otherwise noted.

EN Rising Threshold vs. Temperature

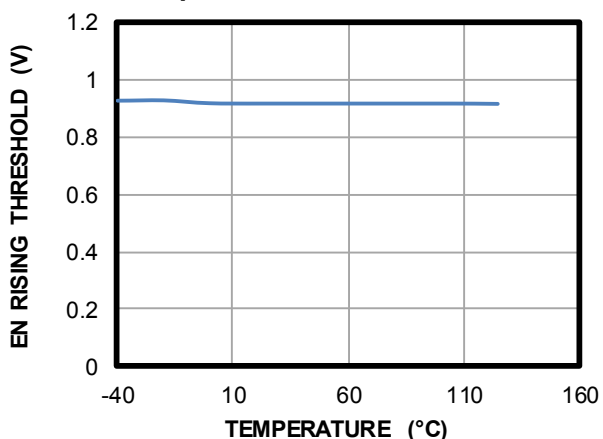

EN UVLO Falling Threshold vs. Temperature

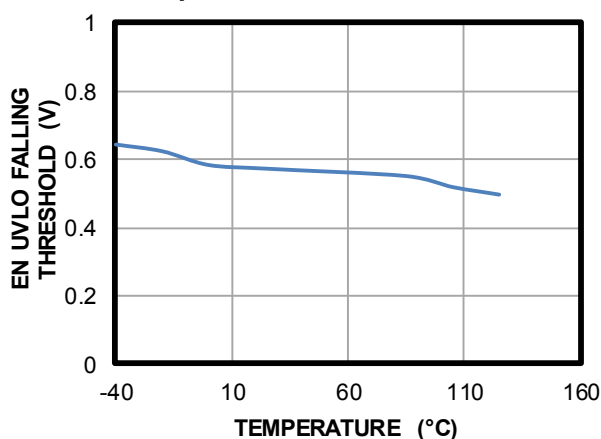

Quiescent Current vs. Temperature

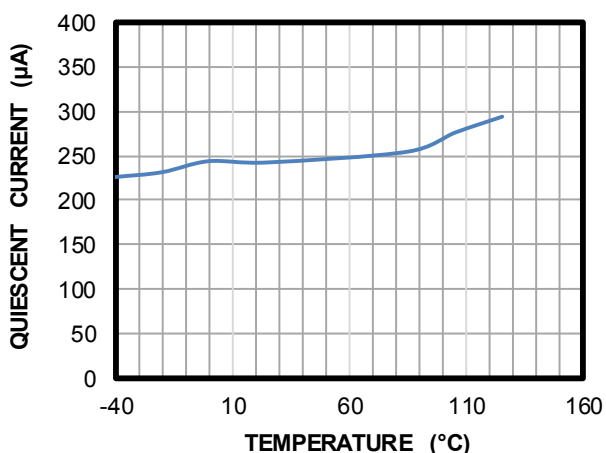

Charge Pump Current Limit vs. Temperature

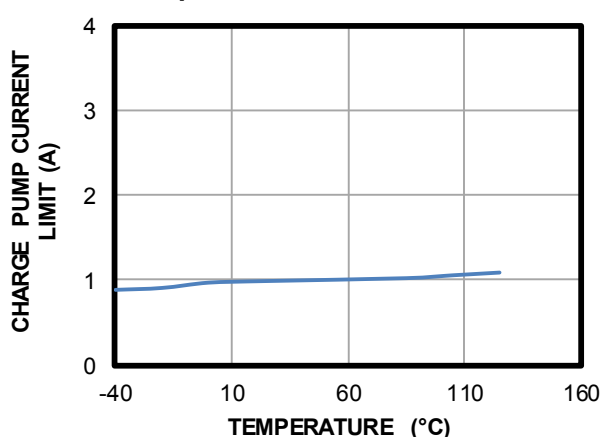

Output1 Discharge Resistor vs. Temperature

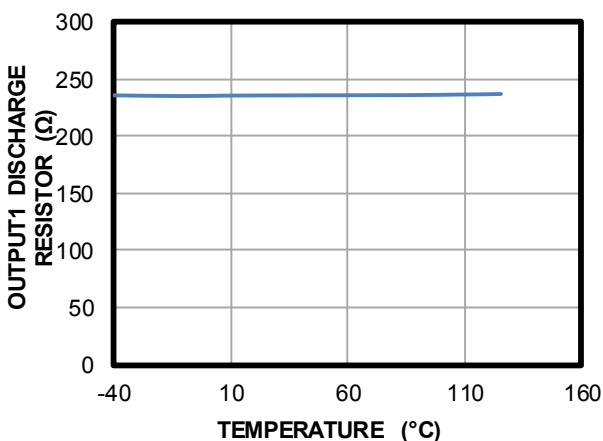

Output2 Discharge Resistor vs. Temperature

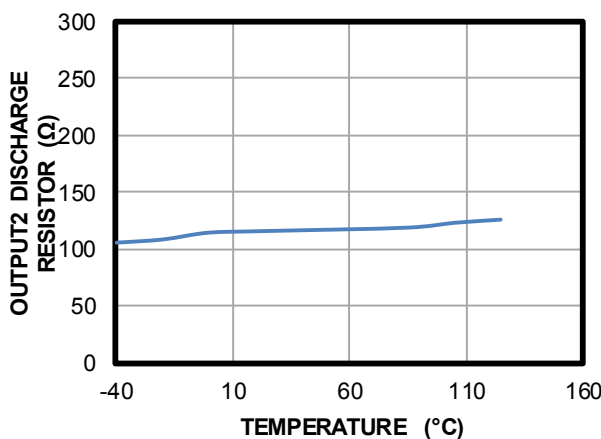



MP5418 – NEGATIVE CHARGE PUMP AND ADJUSTABLE REGULATOR

TYPICAL PERFORMANCE CHARACTERISTICS *(continued)*

$V_{IN} = 3.3V$, $V_{OUT1} = -3.3V$, $V_{OUT2} = -1V$, $C_{IN} = C_{FLY} = C_{OUT1} = C_{OUT2} = 4.7\mu F$, $T_A = +25^\circ C$, unless otherwise noted.

V_{OUT2} Dropout Voltage vs. Temperature

$V_{OUT1} = 3.3V$, $CTL = 3.3V$, $I_{OUT2} = 60mA$

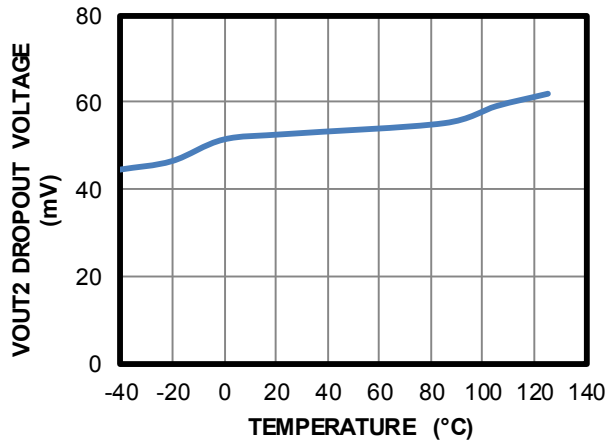

V_{OUT2} Accuracy vs. Temperature

$V_{OUT1} = 3.3V$, $CTL = 3.3V$, $I_{OUT2} = 10mA$

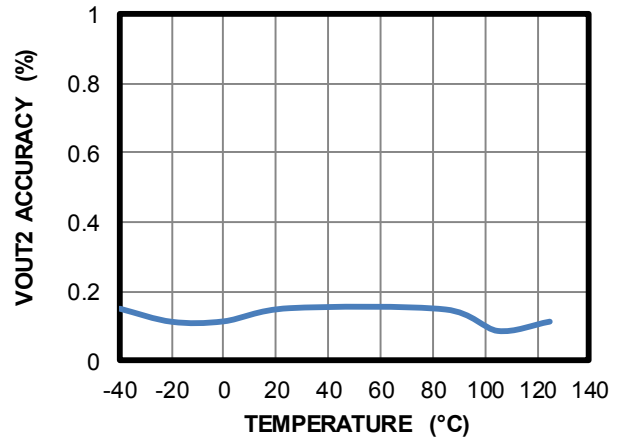



MP5418 – NEGATIVE CHARGE PUMP AND ADJUSTABLE REGULATOR

TYPICAL PERFORMANCE CHARACTERISTICS (continued)

$V_{IN} = 3.3V$, $V_{OUT1} = -3.3V$, $V_{OUT2} = -1V$, $C_{IN} = C_{FLY} = C_{OUT1} = C_{OUT2} = 4.7\mu F$, $T_A = +25^\circ C$, unless otherwise noted.

EN ON/OFF

$V_{IN} = 3.3V$, $CTL = 1V$, $I_{OUT2} = 20mA$

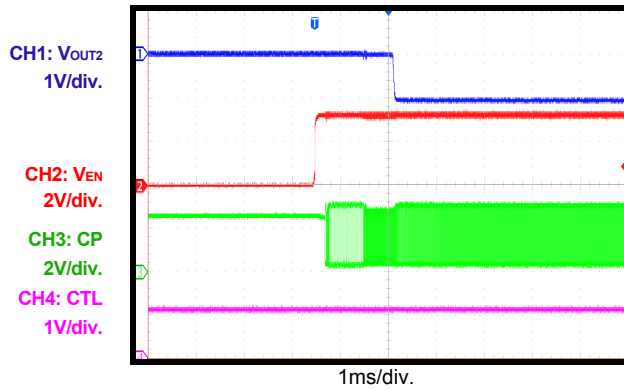

EN ON/OFF

$V_{IN} = 3.3V$, $CTL = 1V$, $I_{OUT2} = 20mA$

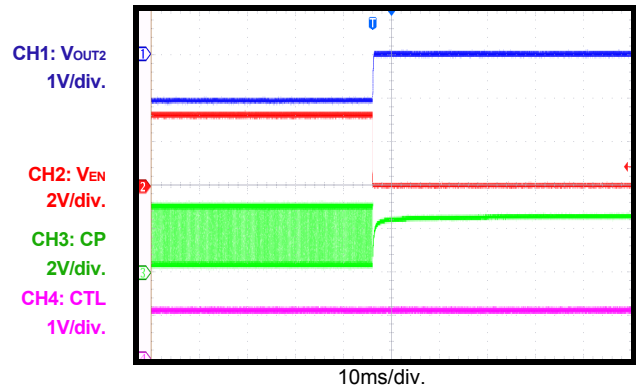

VIN ON/OFF

$V_{IN} = 3.3V$, $CTL = 1V$, $I_{OUT2} = 20mA$

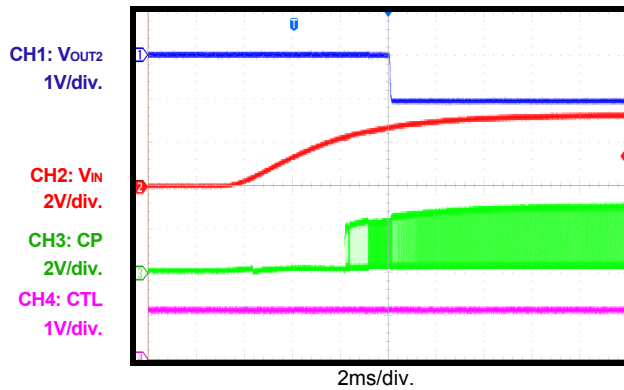

VIN ON/OFF

$V_{IN} = 3.3V$, $CTL = 1V$, $I_{OUT2} = 20mA$

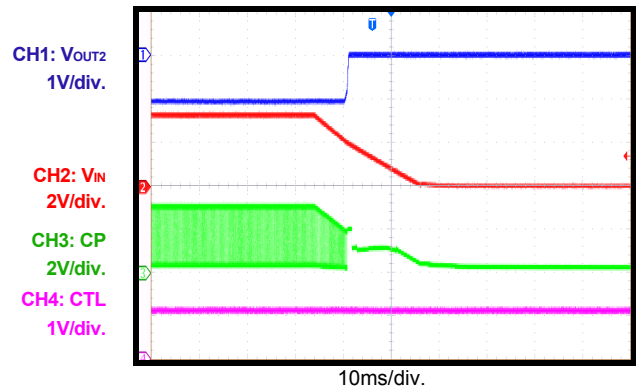

Steady State

$V_{IN} = 3.3V$, $CTL = 1V$, $I_{OUT1} = 0A$, $I_{OUT2} = 0A$

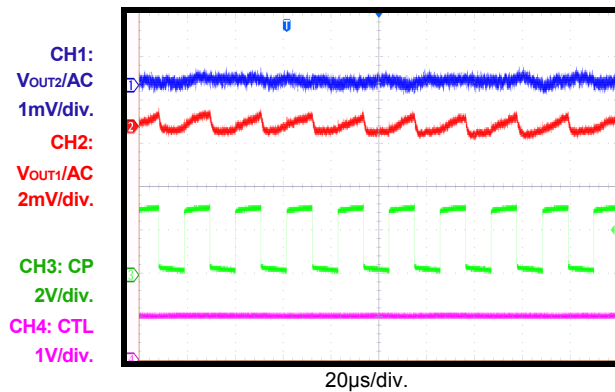

Steady State

$V_{IN} = 3.3V$, $CTL = 1V$, $I_{OUT1} = 0A$, $I_{OUT2} = 20mA$

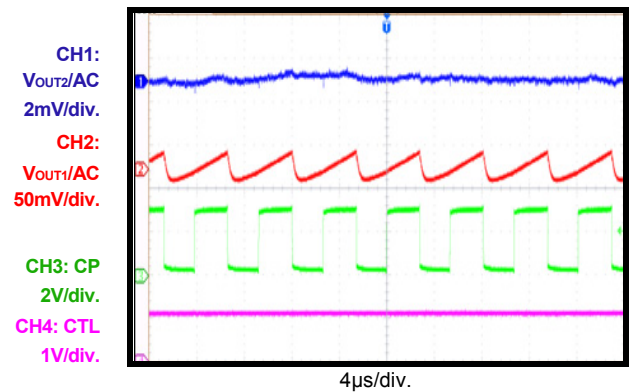



MP5418 – NEGATIVE CHARGE PUMP AND ADJUSTABLE REGULATOR

TYPICAL PERFORMANCE CHARACTERISTICS *(continued)*

$V_{IN} = 3.3V$, $V_{OUT1} = -3.3V$, $V_{OUT2} = -1V$, $C_{IN} = C_{FLY} = C_{OUT1} = C_{OUT2} = 4.7\mu F$, $T_A = +25^\circ C$, unless otherwise noted.

Steady State

$V_{IN} = 3.3V$, $CTL = 1V$, $I_{OUT1} = 0A$, $I_{OUT2} = 60mA$

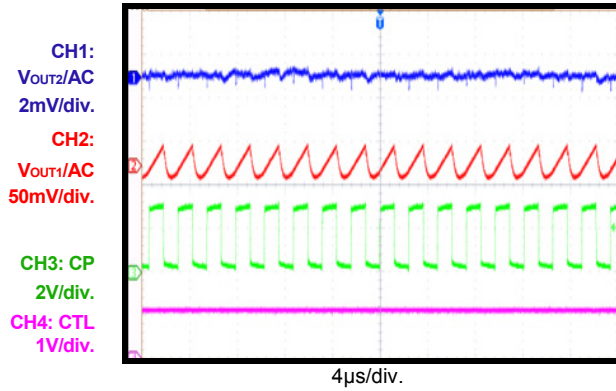



MP5418 – NEGATIVE CHARGE PUMP AND ADJUSTABLE REGULATOR

BLOCK DIAGRAM

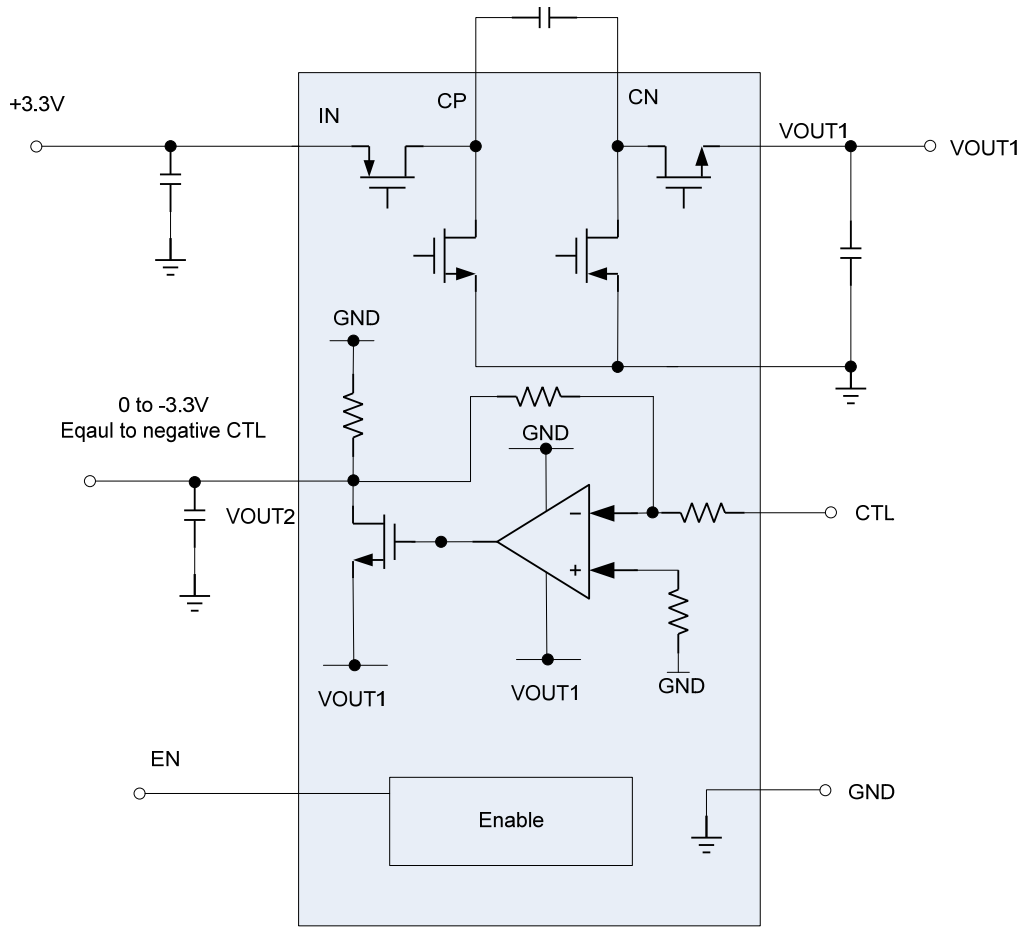

Figure 1: Functional Block Diagram



OPERATION

The MP5418 is a monolithic, negative charge pump with a built-in adjustable negative regulator. It has an input range from 2.3V to 5V and provides an unregulated output equal to the negative input voltage. The MP5418 also provides a regulated output between 0V and the negative input voltage.

No external inductor is required, which reduces space and simplifies design. An internal soft-start circuit effectively reduces the in-rush current during start-up.

Negative Charge Pump

The MP5418 uses a switched capacitor charge pump to get an unregulated negative voltage; the absolute value is V_{IN} . The switching signal, which drives the charge pump, is created by an integrated oscillator within the control circuit block. The oscillator charge pump switching frequency ranges from 30k to 550kHz. The MP5418 will auto adjust the frequency according to the V_{IN} and V_{OUT1} voltage gap. In theory, the oscillator frequency will increase as the load increases. The higher frequency will compensate the output ripple when in a heavy-load condition.

When the absolute value of V_{OUT1} is less than 1V, the charge pump treats it as an over-current condition. The MP5418 will force the oscillator frequency to 45kHz for fold-back.

There is a diode between V_{OUT1} and GND. When the V_{OUT1} voltage is higher than 0.3V, the diode will discharge V_{OUT1} .

Negative Linear Regulator

The MP5418 integrates a negative linear regulator, which is powered from the negative charge pump output. It provides a low dropout voltage and low quiescent supply, low output noise linear regulator. Its output range is from 0 to the V_{OUT1} voltage.

The regulator uses an internal feedback loop to control the output voltage, which equals -1x the CTL pin voltage. This is an easy interface for DAC. Using efficient DAC, its output voltage can be set by an external signal.

The PSRR of the linear regulator is specially designed for its charge pump. The negative linear regulator will have a low output ripple.

Load Capability

The MP5418 load capability is 200mA; the sum of I_{OUT1} and I_{OUT2} is less than 200mA. This load capability is related to the fly and output capacitor. The smaller the capacitor, the smaller the load capability.

Over-Current Protection (OCP)

The charge pump current is limited internally. The device is protected against over-load and over-temperature conditions.

The peak charge pump input current is limited to 1A.

Over-Temperature Protection (OTP)

When the junction temperature is too high, the thermal sensor sends a signal to the control logic that will shut down the IC. The IC will restart when the temperature has sufficiently cooled.

The maximum power output current is a function of the package's maximum power dissipation for a given temperature.

Enable (EN)

When the input voltage is greater than the under-voltage lockout threshold (UVLO), typically 2.2V, the MP5418 can be enabled by pulling EN higher than 0.8V. Floating EN or pulling it down to ground will disable the device. There is an internal 1M Ω resistor from EN to ground.

When the device is disabled, the part goes into output discharge mode automatically, and its internal discharge MOSFET provides a resistive discharge path for the output capacitor.

Equivalent Output Resistance

The equivalent output resistance of the MP5418 is related to the charge pump frequency and fly capacitor. See Equation (1):

$$R_O = \frac{1}{f \cdot C_{Fly}} + 8 \cdot R_{ON} \quad (1)$$

R_{ON} is the on-resistance of each switch MOSFET in the charge pump.

The charge pump output V_{OUT1} voltage is related to I_O and R_O . See Equation (2):

$$V_{OUT1} = -(V_{IN} - I_O \cdot R_O) \quad (2)$$



MP5418 – NEGATIVE CHARGE PUMP AND ADJUSTABLE REGULATOR

Soft Start

The MP5418 linear regulator has an internal soft-start pin that ramps up the output voltage at a controlled slew rate to avoid overshoot at start-up. The soft start slew-rate is set internally to 5V/ms, typical.



APPLICATION INFORMATION

COMPONENT SELECTION

Selecting the Output Capacitor

The output capacitors (C_{OUT1} and C_{OUT2}) stabilize the DC output voltage. For stable operation, use a X5R or X7R ceramic capacitor. Using a $1\mu\text{F}$ capacitor for C_{OUT1} and a $1\mu\text{F}$ - $10\mu\text{F}$ capacitor for C_{OUT2} is recommended. Larger C_{OUT2} values improve load transient response and reduce noise. Output capacitors of other dielectric types may be used but are not recommended, as their capacitance can deviate greatly from their rated value over temperature.

The characteristics of the output capacitor also affect the stability of the regulation system.

Selecting the Input Capacitor

Place a ceramic, dielectric X5R/X7R capacitor (C_{IN}) between $1\mu\text{F}$ - $10\mu\text{F}$ between the input pin and ground. Larger values in this range will improve line transient response.

Selecting the Fly Capacitor

The fly capacitor will affect the output resistance and V_{OUT1} voltage. If the output current is high, a larger fly capacitor is recommended. Placing the fly capacitor close to C_{IN} and C_{OUT1} is recommended. Using the same capacitor for C_{IN} , C_{OUT1} and C_{FLY} is ideal.

Setting the Output Voltage

The linear regulator will follow the CTL voltage. The output value is regulated to $-1\times$ the CTL voltage. CTL is an analog input and can be directly connected to the DAC output. Figure 2 shows the application circuit.

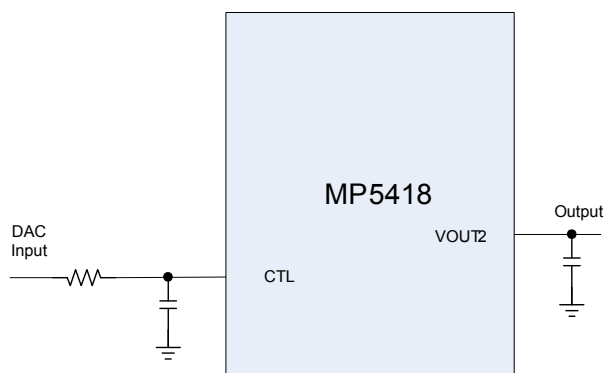

Figure 2: Output Voltage Setting

PCB Layout

Efficient PCB layout is critical to achieve good regulation, ripple rejection, transient response, and thermal performance. Duplicating the EVB layout is recommended for optimum performance. For best results, refer to Figure 3 and follow the guidelines below.

1. Place the high-current paths (GND, IN, CP and CN) very close to the device with short, direct, and wide traces.
2. Place the input capacitor as close as possible to IN and GND.
3. Place the GND output capacitor as close as possible to the GND pins.

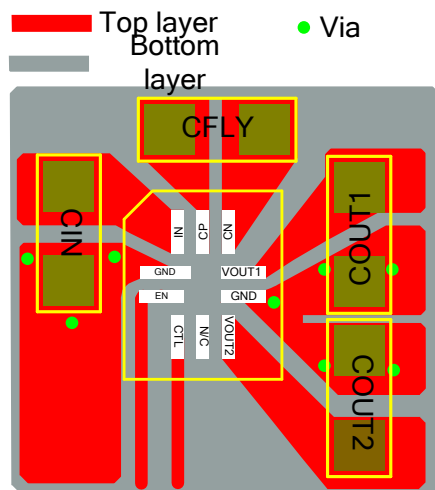

Figure 3: Recommended PCB Layout.

Design Example

Table 1 is a design example following the application guidelines for the specifications below:

Table 1: Design Example

V_{IN}	3.3V
V_{OUT1}	-3.3V
V_{CTL}	1V
V_{OUT2}	-1V

The detailed application schematic is shown in Figure 4. The typical performance and circuit waveforms are shown in the Typical Performance Characteristics section. For more device applications, please refer to the related evaluation board datasheets.



MP5418 – NEGATIVE CHARGE PUMP AND ADJUSTABLE REGULATOR

TYPICAL APPLICATION CIRCUITS

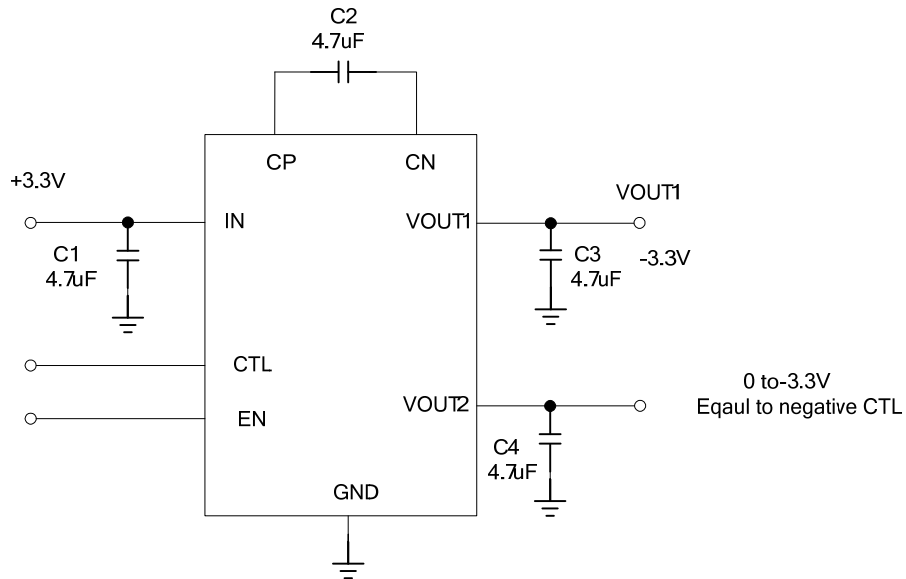

Figure 4: Typical Application Circuit



MP5418 – NEGATIVE CHARGE PUMP AND ADJUSTABLE REGULATOR

PACKAGE INFORMATION

QFN-10 (1.4mmx1.8mm)

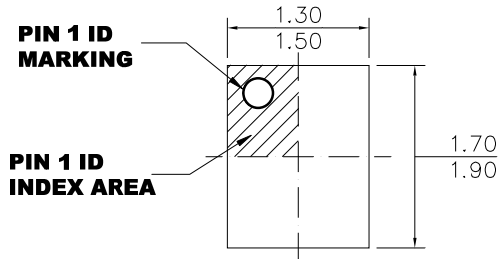

TOP VIEW

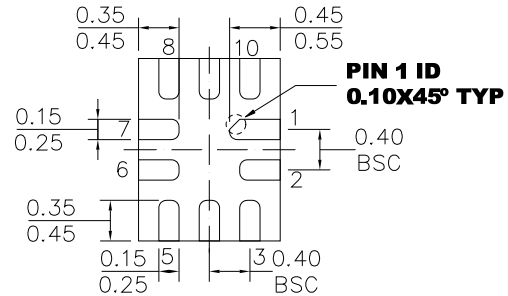

BOTTOM VIEW

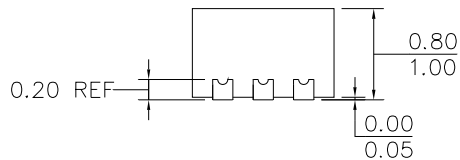

SIDE VIEW

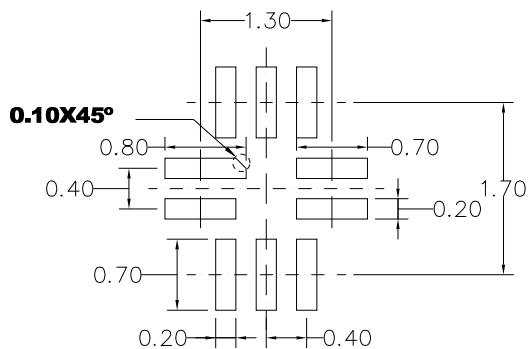

RECOMMENDED LAND PATTERN

NOTE:

- 1) ALL DIMENSIONS ARE IN MILLIMETERS.
- 2) LEAD COPLANARITY SHALL BE 0.08 MILLIMETERS MAX.
- 3) JEDEC REFERENCE IS MO-220.
- 4) DRAWING IS NOT TO SCALE.

NOTICE: The information in this document is subject to change without notice. Users should warrant and guarantee that third party Intellectual Property rights are not infringed upon when integrating MPS products into any application. MPS will not assume any legal responsibility for any said applications.

OUR CERTIFICATE

DiGi provide top-quality products and perfect service for customer worldwide through standardization, technological innovation and continuous improvement. DiGi through third-party certification, we stricly control the quality of products and services. Welcome your RFQ to

Email: Info@DiGi-Electronics.com



Tel: +00 852-30501935

RFQ Email: Info@DiGi-Electronics.com

DiGi is a global authorized distributor of electronic components.