

MP8110DS-LF-Z Datasheet

www.digi-electronics.com

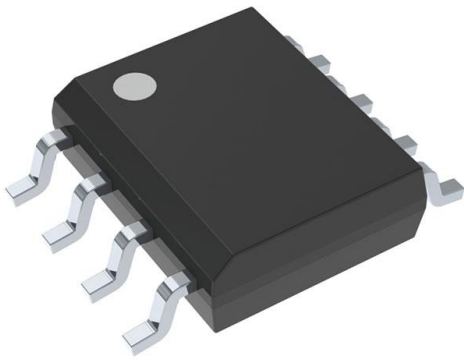

<https://www.DiGi-Electronics.com>

DiGi Electronics Part Number	MP8110DS-LF-Z-DG
Manufacturer	Monolithic Power Systems Inc.
Manufacturer Product Number	MP8110DS-LF-Z
Description	IC CURRENT SENSE 1 CIRCUIT 8SOIC
Detailed Description	Current Sense Amplifier 1 Circuit 8-SOIC



Tel: +00 852-30501935

RFQ Email: Info@DiGi-Electronics.com

DiGi is a global authorized distributor of electronic components.

Purchase and inquiry

Manufacturer Product Number:

MP8110DS-LF-Z

Series:

-

Amplifier Type:

Current Sense

Output Type:

-

Current - Input Bias:

4 nA

Current - Supply:

12 μ A

Voltage - Supply Span (Max):

40 V

Mounting Type:

Surface Mount

Supplier Device Package:

8-SOIC

Manufacturer:

Monolithic Power Systems Inc.

Product Status:

Active

Number of Circuits:

1

Slew Rate:

-

Voltage - Input Offset:

1 mV

Voltage - Supply Span (Min):

2.5 V

Operating Temperature:

-40°C ~ 85°C

Package / Case:

8-SOIC (0.154", 3.90mm Width)

Base Product Number:

MP8110

Environmental & Export classification

RoHS Status:

ROHS3 Compliant

REACH Status:

REACH Unaffected

HTSUS:

8542.33.0001

Moisture Sensitivity Level (MSL):

2 (1 Year)

ECCN:

EAR99



The Future of Analog IC Technology®

MP8110

Precision High-Side Current-Sense Amplifier

DESCRIPTION

The MP8110 is a low-cost, precision, high-side current-sense amplifier. This device operates from a single 2.5V to 40V supply and typically consumes 12 μ A. It is ideal for today's notebook computers, cell phones and other systems where battery/DC current monitoring is critical.

High-side current monitoring is especially useful in battery-powered systems since it does not interfere with the ground path of the battery charger. The input common-mode range of 1.4V to 40V is independent of the supply voltage and ensures that the current-sense feedback remains viable even when connected to a 2-cell battery pack in deep discharge.

This device is available in 8-pin SOIC and MSOP packages.

FEATURES

- Low-Cost, Compact Current-Sense Solution
- 12 μ A Typical Supply Current
- 2.5V to 40V Operating Supply Voltage
- 1.4V to 40V Input Common Mode Range
- 3 μ A Typical Shutdown Current
- 400 μ V Input Offset Voltage
- High Current Sensing Capability
- Integrated Buffer Amplifier
- Available in 8-Pin SOIC and MSOP packages,

APPLICATIONS

- Portable PCs
- PDA's
- Smart Battery Packs
- Cell Phones
- Portable Test/Measurement Systems
- Battery-Operated Systems
- Energy Management Systems

"MPS" and "The Future of Analog IC Technology" are Registered Trademarks of Monolithic Power Systems, Inc.

TYPICAL APPLICATION

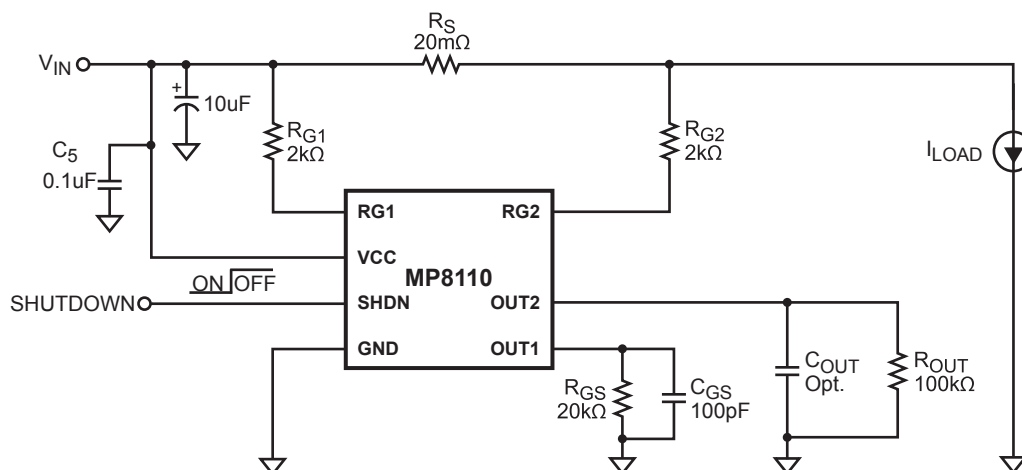



PACKAGE REFERENCE

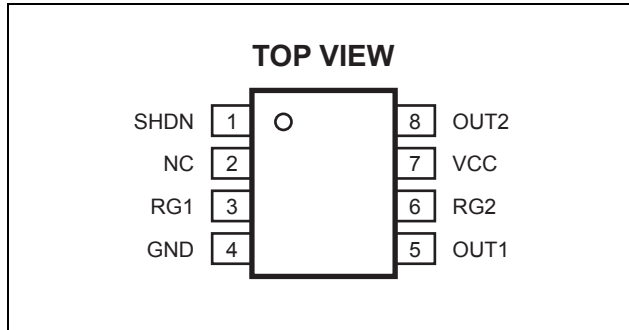

Part Number*	Package	Temperature
MP8110DS	SOIC8	-40°C to +85°C

* For Tape & Reel, add suffix -Z (eg. MP8110DS-Z)
For RoHS Compliant Packaging, add suffix -LF
(eg. MP8110DS-LF-Z)

ABSOLUTE MAXIMUM RATINGS ⁽¹⁾

V_{CC}, RG1, RG2 to GND.....-0.3V to +42V
Max Differential Input Voltage, RG1 to RG2..... 5V
Max Junction Temperature (T_j) 150°C
Storage Temperature -65°C to +150°C

Recommended Operating Conditions ⁽²⁾

V_{CC}, RG1, RG2 to GND2.5V to 40V
Operating Ambient Temperature-40°C to +85°C

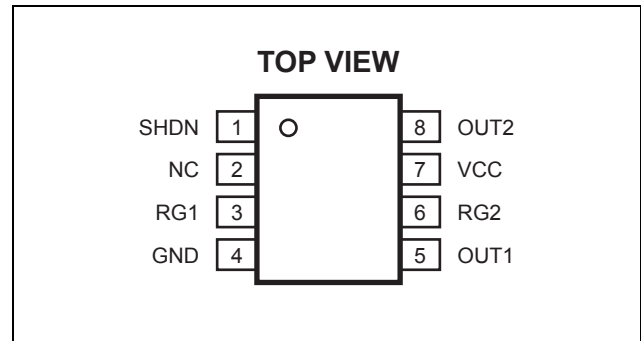

Part Number*	Package	Temperature
MP8110DK	MSOP8	-40°C to +85°C

* For Tape & Reel, add suffix -Z (eg. MP8110DK-Z)
For RoHS Compliant Packaging, add suffix -LF
(eg. MP8110DK-LF-Z)

Thermal Resistance ⁽³⁾	θ_{JA}	θ_{JC}
SOIC8	90	42... °C/W
MSOP8	150	65... °C/W
Continuous Power Dissipation (T _A =70°C)	800mW	

Notes:

- 1) Exceeding these ratings may damage the device.
- 2) The device is not guaranteed to function outside of its operating conditions.
- 3) Measured on approximately 1" square of 1 oz copper.

ELECTRICAL CHARACTERISTICS

V_{CC} = 24V, V_{SHDN} = 0V, T_A = +25°C, unless otherwise noted.

Parameter	Symbol	Conditions	Min	Typ	Max	Units
Supply Voltage	V _{CC}		2.5		40	V
Supply Current	I _{CC}	I _{LOAD} = 0A, V _{CC} = 40V		12	30	μA
Common Mode Input Voltage	V _{IN,CM}	V _{CC} > V _{IN} Low		1.4		V
		V _{CC} > V _{IN} High		40		
OUT1 Input Offset Voltage	V _{OS1}			0.4	2	mV
OUT2 Input Offset Voltage	V _{OS2}			1	5	mV
Input Bias Current ⁽⁴⁾	I _{RG1} , I _{RG2}			4	20	nA
OUT1 Current Accuracy	I _{RG1} /I _{GS}	V _{SENSE} = 100mV		±2	±5	%
No-Load OUT1 Error		V _{SENSE} = 0V		0.1	1	μA
Low-Level OUT1 Error		V _{SENSE} = 5mV		0.3	2	μA
No-Load OUT2 Error		V _{SENSE} = 0V		0.01	1	μA
Low-Level OUT2 Error		V _{SENSE} = 5mV		0.05	2	μA
Power Supply Rejection Ratio	PSRR	2.5V < V _{CC} < 40V, V _{SENSE} = 100mV	70	97		dB
Shutdown Supply Current	I _{CC(SHDN)}	V _{SHDN} = 3V		3	6	μA

**ELECTRICAL CHARACTERISTICS** *(continued)* $V_{CC} = 24V$, $V_{SHDN} = 0V$, $T_A = +25^{\circ}C$, unless otherwise noted.

Parameter	Symbol	Conditions	Min	Typ	Max	Units
SHDN Threshold Voltage	$V_{TH_SHUTDOWN}$	(Low - High)	0.7	0.9	1.2	V
SHDN Hysteresis				30		mV
OUT1 Rise, Fall Time ⁽⁴⁾	t_R	$V_{SENSE} = 40mV$, $R_{GS} = 20k\Omega$, $R_{OUT} = 100k\Omega$,		17		μs
	t_F	$R_{G1} = R_{G2} = 2k\Omega$, $C_{GS} = 100pF$, $C_{OUT} = 100pF$, 10% to 90%		29		
OUT2 Rise, Fall Time ⁽⁴⁾	t_R	$V_{SENSE} = 40mV$, $R_{GS} = 20k\Omega$, $R_{OUT} = 100k\Omega$,		18		μs
	t_F	$R_{G1} = R_{G2} = 2k\Omega$, $C_{GS} = 100pF$, $C_{OUT} = 100pF$, 10% to 90%		26		
OUT1 Output Voltage Range	V_{GS}			$V_{CC} - 0.15$	24	V
OUT2 Output Voltage Range	V_{OUT}			$V_{CC} - 1$	24	V
Maximum OUT1 Current ⁽⁴⁾	I_{GS}			500		μA
Maximum OUT2 Current ⁽⁴⁾	I_{OUT2}			5		mA

Notes:

4) Guaranteed by design.

5) Input common mode range cannot exceed the supply voltage.

PIN FUNCTIONS

SOIC8	Name	Description
1	SHDN	Shutdown. Connect to ground for normal operation. When high, supply current is less than 3 μA .
2	NC	Not Connected.
3	RG1	Gain Resistor. Connect to battery side of current-sense resistor through the gain resistor.
4	GND	Ground or Battery Negative Terminal.
5	OUT1	Output for Driving Resistor Load.
6	RG2	Gain Resistor. Connect to load side of current-sense resistor through the gain resistor.
7	VCC	Power Input. Connect to Battery Input.
8	OUT2	Output For Driving Capacitive Loads.



OPERATION

The MP8110 is a current-sense amplifier with a wide operating input voltage range of 2.5V to 40V. It has 1.4V to 40V Common-Mode range.

This feature allows the monitoring of current flow out of a battery in deep discharge, and also enables high-side current sensing up to the supply voltage, V_{CC} . Current flows through the sense resistor, R_S , which generates a sense voltage V_{RS} . The high precision sense amplifier built into the MP8110 monitors the differential voltage across R_S and dynamically adjusts the gate voltage of the internal P-channel MOSFET to maintain an equal passing current as I_{RG1} . The current amplifier gain is therefore set as: R_{GS} / R_{G1} .

Choosing Sensing Resistor

Given the gain and maximum load current, select R_S such that V_{RS} does not exceed +0.25V and V_{OUT1} does not exceed 5V. To measure lower currents more accurately, use a high value for R_S . A higher value develops a higher sense voltage, which overcomes offset voltage errors of the internal current amplifier.

In applications of monitoring very high current, ensure R_S is able to dissipate its own I^2R losses. If the resistor rating power is exceeded, its value may drift or it may fail altogether, causing a differential voltage across the terminals in excess of the absolute maximum range (0.25V).

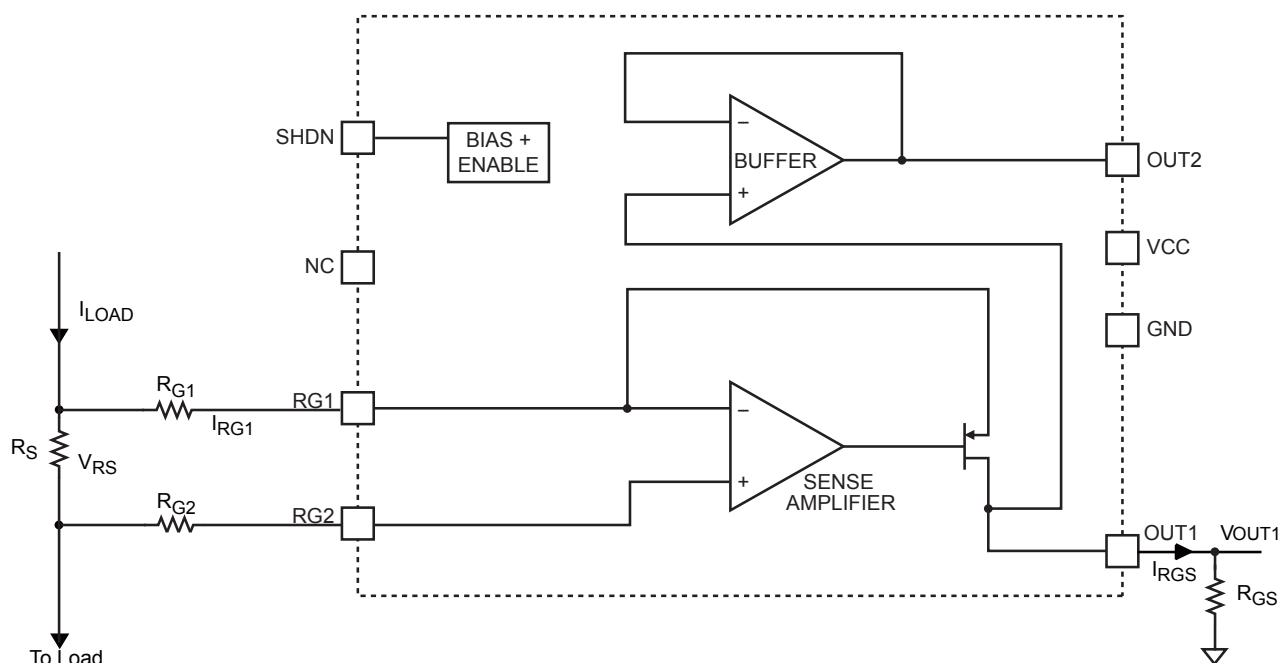

Figure 1—Functional Block Diagram

APPLICATION INFORMATION

COMPONENT SELECTION

Table 1—Suggested Component Values (refer to Typical Circuit on page 1)

Full-Scale Load Current, I_{SENSE} (A)	Current Sense Resistor (m Ω)	Gain Setting Resistor (k Ω) ($R_{G1} = R_{G2}$)	R_{GS} (k Ω)	Gain
0.1	500	2	20	10
1	50	2	20	10
5	10	2	20	10
10	5	2	20	10

The value of V_{OUT1} can be obtained with the equation:

$$V_{OUT1} = \frac{I_{LOAD} \times R_S \times R_{GS}}{R_{G1}} = I_{LOAD} \times R_S \times \text{Gain}$$

Where R_{G1} is the sense resistor and I_{LOAD} is the load current.



TYPICAL PERFORMANCE CHARACTERISTICS

$V_{IN}=24V$, $R_{G1}=R_{G2}=2K\Omega$, $R_{G3}=20K\Omega$, $R_S=20m\Omega$, $C_{GS}=100pF$, $C_5=0.1\mu F$, $T_A=+25^\circ C$, unless otherwise noted.

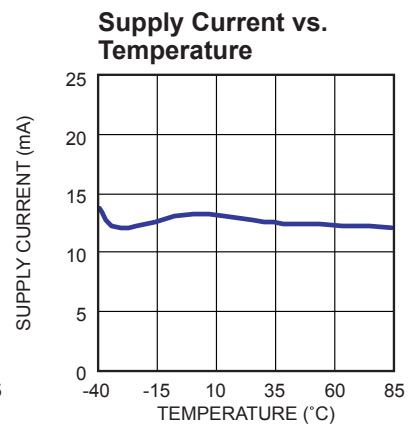
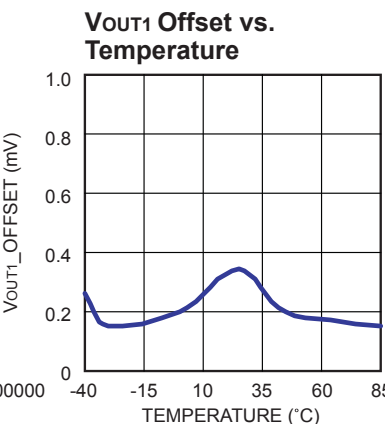
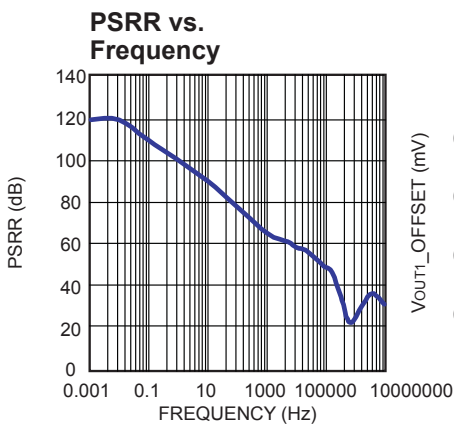
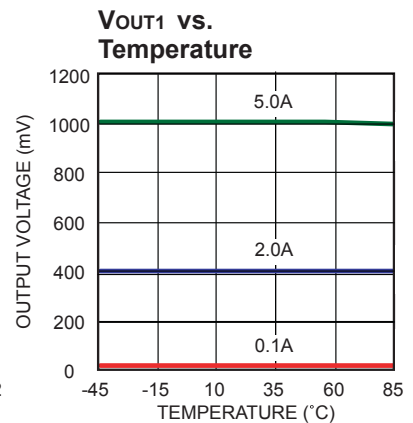
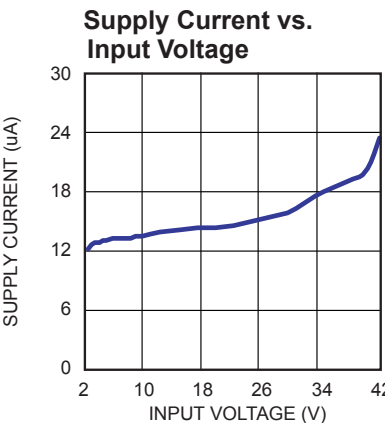
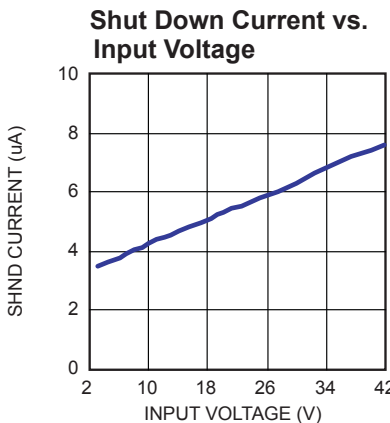
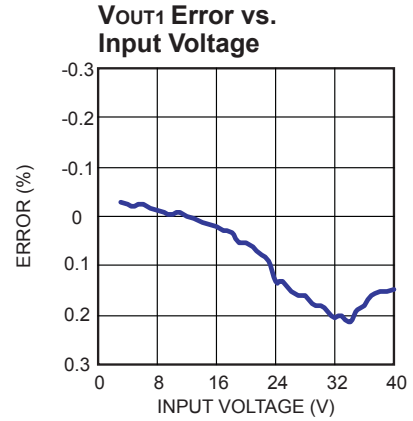
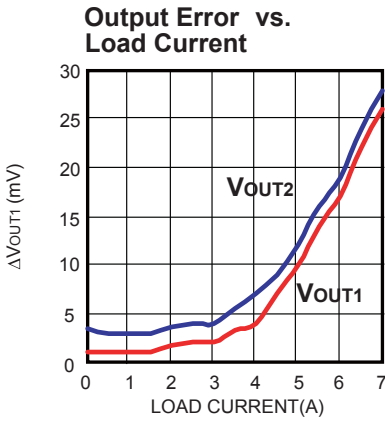
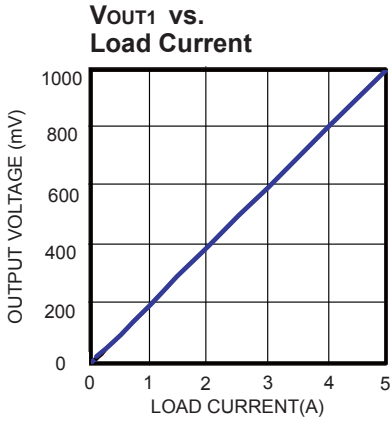



TYPICAL PERFORMANCE CHARACTERISTICS *(continued)*

$V_{IN}=24V$, $R_{G1}=R_{G2}=2K\Omega$, $R_{G3}=20K\Omega$, $R_S=20m\Omega$, $C_{GS}=100pF$, $C_5=0.1\mu F$, $T_A=+25^\circ C$, unless otherwise noted.

SHND High to Low

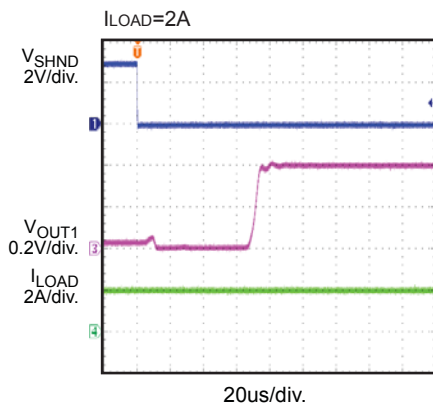

SHDN Low to High

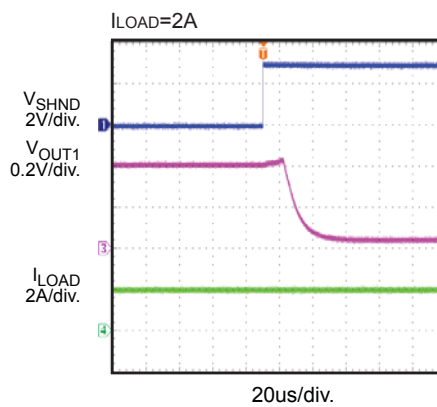

Transient Response

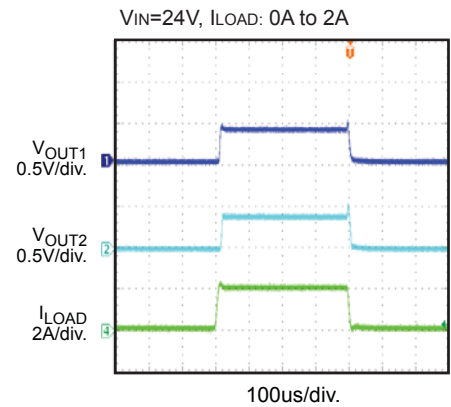

Transient Response

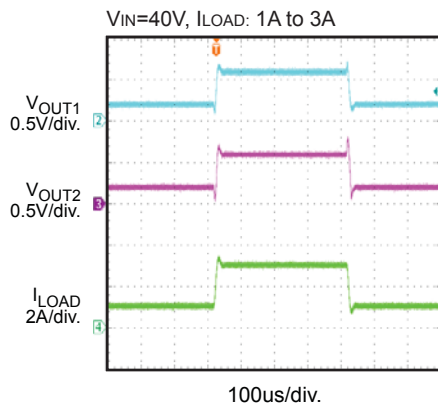



PACKAGE INFORMATION

SOIC8

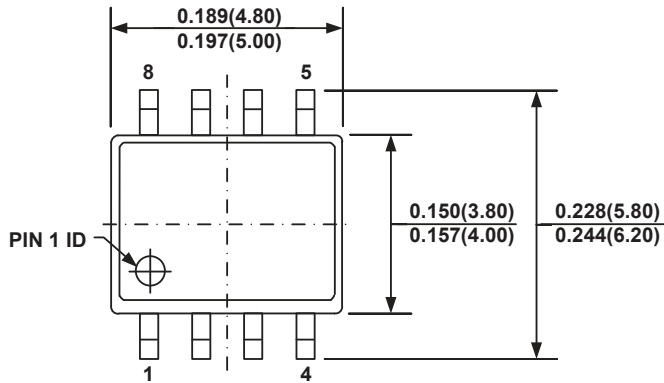

TOP VIEW

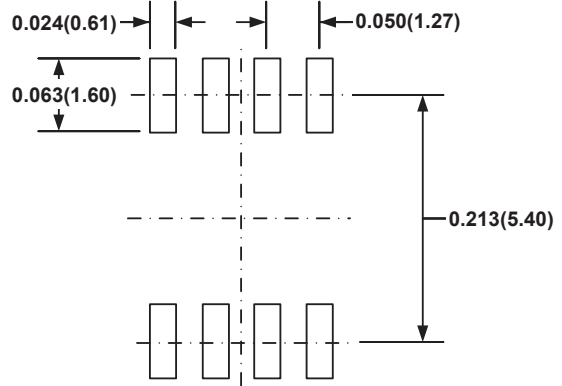

RECOMMENDED LAND PATTERN

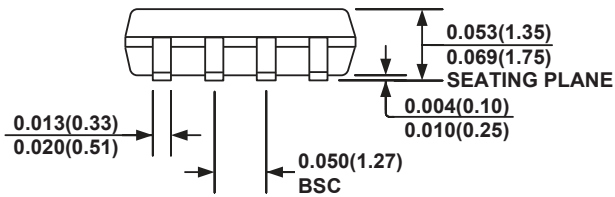

FRONT VIEW

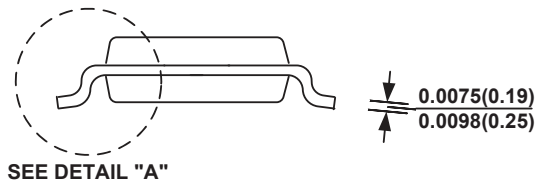

SIDE VIEW

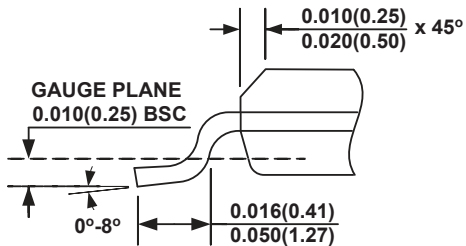

DETAIL "A"

NOTE:

- 1) CONTROL DIMENSION IS IN INCHES. DIMENSION IN BRACKET IS IN MILLIMETERS.
- 2) PACKAGE LENGTH DOES NOT INCLUDE MOLD FLASH, PROTRUSIONS OR GATE BURRS.
- 3) PACKAGE WIDTH DOES NOT INCLUDE INTERLEAD FLASH OR PROTRUSIONS.
- 4) LEAD COPLANARITY (BOTTOM OF LEADS AFTER FORMING) SHALL BE 0.004" INCHES MAX.
- 5) DRAWING CONFORMS TO JEDEC MS-012, VARIATION AA.
- 6) DRAWING IS NOT TO SCALE.



MP8110 – PRECISION HIGH-SIDE CURRENT-SENSE AMPLIFIER

MSOP8

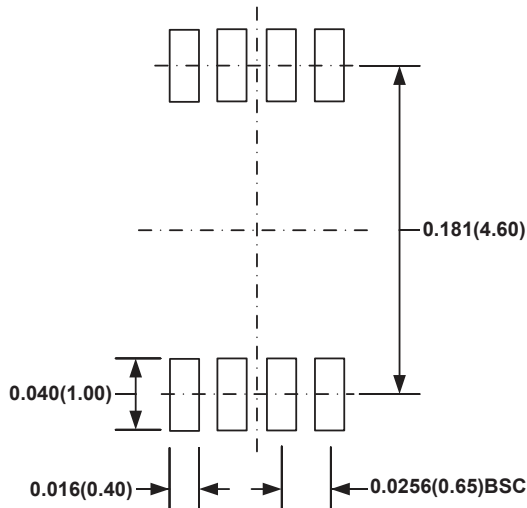
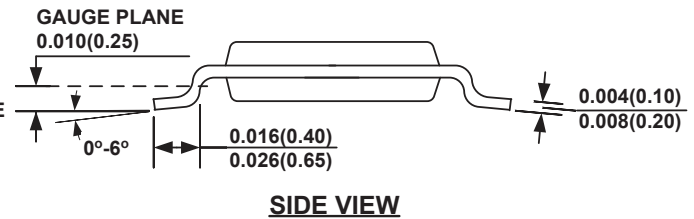
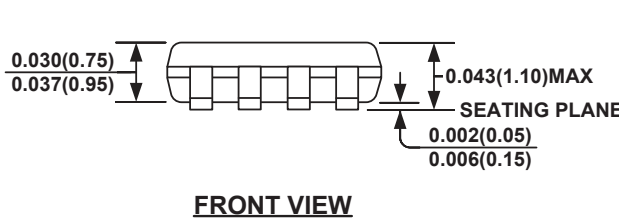
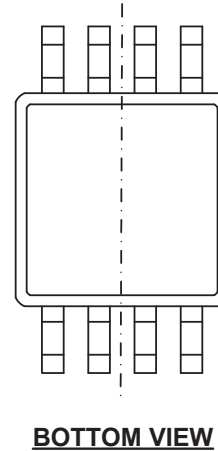
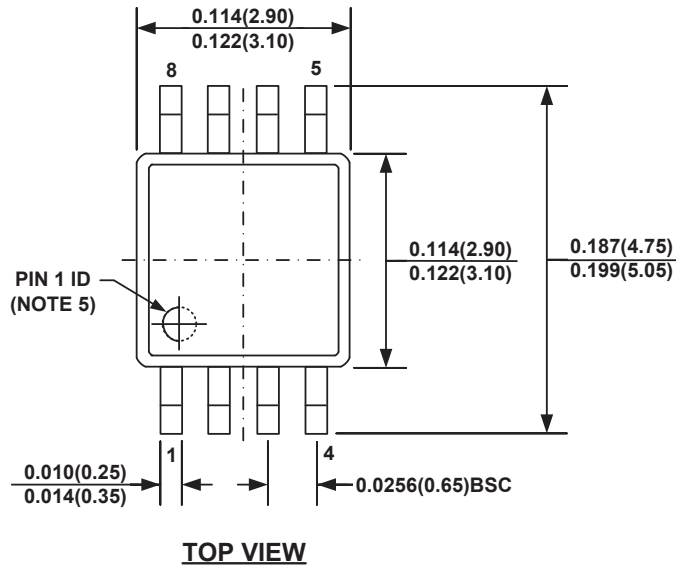

NOTE:

- 1) CONTROL DIMENSION IS IN INCHES. DIMENSION IN BRACKET IS IN MILLIMETERS.
- 2) PACKAGE LENGTH DOES NOT INCLUDE MOLD FLASH, PROTRUSION OR GATE BURR.
- 3) PACKAGE WIDTH DOES NOT INCLUDE INTERLEAD FLASH OR PROTRUSION.
- 4) LEAD COPLANARITY (BOTTOM OF LEADS AFTER FORMING) SHALL BE 0.004" INCHES MAX.
- 5) PIN 1 IDENTIFICATION HAS HALF OR FULL CIRCLE OPTION.
- 6) DRAWING MEETS JEDEC MO-187, VARIATION AA.
- 7) DRAWING IS NOT TO SCALE.

NOTICE: The information in this document is subject to change without notice. Users should warrant and guarantee that third party Intellectual Property rights are not infringed upon when integrating MPS products into any application. MPS will not assume any legal responsibility for any said applications.

OUR CERTIFICATE

DiGi provide top-quality products and perfect service for customer worldwide through standardization, technological innovation and continuous improvement. DiGi through third-party certification, we stricly control the quality of products and services. Welcome your RFQ to

Email: Info@DiGi-Electronics.com



Tel: +00 852-30501935

RFQ Email: Info@DiGi-Electronics.com

DiGi is a global authorized distributor of electronic components.