

# PESD5V0S1BSF,315 Datasheet



[www.digi-electronics.com](http://www.digi-electronics.com)

<https://www.DiGi-Electronics.com>

DiGi Electronics Part Number	PESD5V0S1BSF,315-DG
Manufacturer	<a href="#">Nexperia USA Inc.</a>
Manufacturer Product Number	PESD5V0S1BSF,315
Description	TVS DIODE 5VWM 15.5VC DSN0603-2
Detailed Description	15.5V Clamp 8A (8/20μs) Ipp Tvs Diode Surface Mount DSN0603-2

This model PESD5V0S1BSF,315 is available at DiGi Electronics.

DiGi Electronics offers a global database of semiconductor and electronic component datasheets.

We welcome your inquiries regarding pricing, lead time, or other product-related questions.

 [Request a Quote](#)

 [Datasheet Search](#)



Tel: +00 852-30501935

RFQ Email: [Info@DiGi-Electronics.com](mailto:Info@DiGi-Electronics.com)

DiGi is a global authorized distributor of electronic components.



## Purchase and inquiry

Manufacturer Product Number:

PESD5V0S1BSF,315

Series:

-

Type:

Zener

Voltage - Reverse Standoff (Typ):

5V (Max)

Voltage - Clamping (Max) @ Ipp:

15.5V

Power - Peak Pulse:

100W

Applications:

General Purpose

Operating Temperature:

-55°C ~ 150°C (TA)

Package / Case:

0201 (0603 Metric)

Base Product Number:

PESD5

Manufacturer:

Nexperia USA Inc.

Product Status:

Active

Bidirectional Channels:

1

Voltage - Breakdown (Min):

6V

Current - Peak Pulse (10/1000µs):

8A (8/20µs)

Power Line Protection:

No

Capacitance @ Frequency:

35pF @ 1MHz

Mounting Type:

Surface Mount

Supplier Device Package:

DSN0603-2

## Environmental & Export classification

RoHS Status:

ROHS3 Compliant

REACH Status:

REACH Unaffected

HTSUS:

8541.10.0080

Moisture Sensitivity Level (MSL):

1 (Unlimited)

ECCN:

EAR99



# PESD5V0S1BSF

Ultra low profile bidirectional low capacitance  
ESD protection diode

Rev. 2 — 18 February 2011

Product data sheet

## 1. Product profile

### 1.1 General description

Low capacitance bidirectional ElectroStatic Discharge (ESD) protection diode in a SOD962 leadless ultra small Surface-Mounted Device (SMD) package designed to protect one signal line from the damage caused by ESD and other transients.

### 1.2 Features and benefits

- Pb-free, Restriction of Hazardous Substances (RoHS) compliant and free of halogen and antimony (Dark Green compliant)
- Bidirectional ESD protection of one line
- Low diode capacitance  $C_d = 35$  pF
- ESD protection up to  $\pm 30$  kV according IEC 61000-4-2
- Ultra small SMD package
- Symmetrical breakdown voltage

### 1.3 Applications

- Cellular handsets and accessories
- Portable electronics
- Communication systems
- Computers and peripherals

### 1.4 Quick reference data

**Table 1. Quick reference data**

$T_{amb} = 25$  °C unless otherwise specified.

Symbol	Parameter	Conditions	Min	Typ	Max	Unit
$V_{RWM}$	reverse standoff voltage		-5	-	5	V
$C_d$	diode capacitance	$f = 1$ MHz; $V_R = 0$ V	[1] 25	35	45	pF

[1] This parameter is guaranteed by design.

## 2. Pinning information

**Table 2. Pinning**

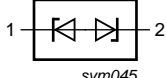
Pin	Description	Simplified outline	Graphic symbol
1	cathode (diode 1)	 <p>Transparent top view</p>	 <p>sym045</p>
2	cathode (diode 2)		

## 3. Ordering information

**Table 3. Ordering information**

Type number	Package		
	Name	Description	Version
PESD5V0S1BSF -		leadless ultra small package; 2 terminals; body 0.6 × 0.3 × 0.3 mm	SOD962

## 4. Marking

**Table 4. Marking codes**

Type number	Marking code
PESD5V0S1BSF	S

## 5. Limiting values

**Table 5. Limiting values**

*In accordance with the Absolute Maximum Rating System (IEC 60134).*

Symbol	Parameter	Conditions	Min	Max	Unit
$P_{PP}$	peak pulse power	$t_p = 8/20 \mu s$	[1][2] -	100	W
$I_{PP}$	peak pulse current	$t_p = 8/20 \mu s$	[1][2] -	8	A
$T_j$	junction temperature		-	150	°C
$T_{amb}$	ambient temperature		-55	+150	°C
$T_{stg}$	storage temperature		-65	+150	°C

[1] Non-repetitive current pulse 8/20  $\mu s$  exponentially decaying waveform according to IEC 61000-4-5; see [Figure 1](#).

[2] Measured from pin 1 to pin 2.

**Table 6. ESD maximum ratings**

Symbol	Parameter	Conditions	Min	Max	Unit
$V_{ESD}$	electrostatic discharge voltage	IEC 61000-4-2 (contact discharge)	[1][2] -	30	kV
		IEC 61000-4-2 (air discharge)	-	30	kV
		MIL-STD-883 (human body model)	-	30	kV

[1] Measured from pin 1 to pin 2.

[2] Device stressed with ten non-repetitive ESD pulses; see [Figure 2](#).

**Table 7. ESD standards compliance**

Standard	Conditions
IEC 61000-4-2, level 4 (ESD)	> 15 kV (air); > 8 kV (contact)
MIL-STD-883; class 3 (human body model)	> 4 kV

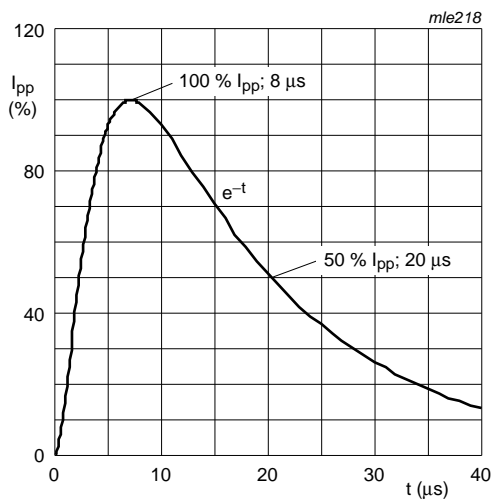

**Fig 1. 8/20  $\mu$ s pulse waveform according to IEC 61000-4-5**

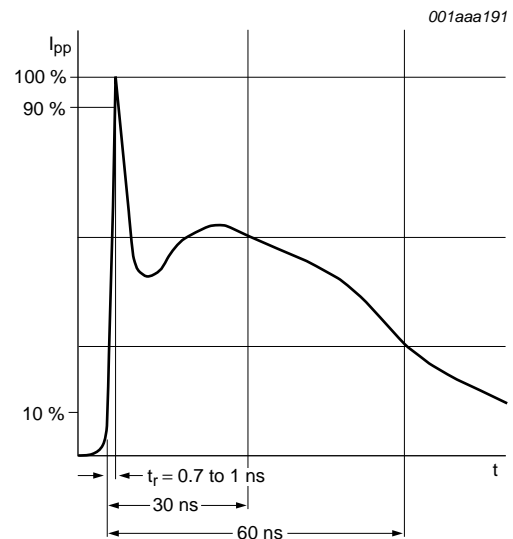

**Fig 2. ESD pulse waveform according to IEC 61000-4-2**

## 6. Characteristics

**Table 8. Characteristics**

$T_{amb} = 25\text{ }^{\circ}\text{C}$  unless otherwise specified.

Symbol	Parameter	Conditions	Min	Typ	Max	Unit	
<b>Per diode</b>							
$V_{RWM}$	reverse standoff voltage		-5	-	5	V	
$I_{RM}$	reverse leakage current	$V_{RWM} = 5\text{ V}$	-	1	100	nA	
$V_{CL}$	clamping voltage	$I_{PP} = 1\text{ A}$	[1][2]	-	-	12	V
		$I_{PP} = 8\text{ A}$	[1][2]	-	-	15.5	V
$V_{BR}$	breakdown voltage	$I_R = 1\text{ mA}$	[3]	6	-	10	V
		$I_R = -1\text{ mA}$	[3]	-10	-	-6	V
$C_d$	diode capacitance	$f = 1\text{ MHz}$	[4]				
		$V_R = 0\text{ V}$		25	35	45	pF
		$V_R = 2.5\text{ V}$		-	26.5	35	pF
		$V_R = 5\text{ V}$		-	23.7	31	pF
$L_S$	series inductance		[5]	-	0.05	-	nH
$R_{dyn}$	dynamic resistance		[6]	-	0.28	-	$\Omega$

- [1] Non-repetitive current pulse 8/20  $\mu\text{s}$  exponentially decaying waveform according to IEC 61000-4-5; see [Figure 1](#).
- [2] Measured from pin 1 to pin 2.
- [3] Breakdown voltage is always symmetrical within the characterized range, which means no difference in breakdown voltage from pin 1 to pin 2 and vice versa.
- [4] This parameter is guaranteed by design.
- [5] Calculated from S-parameter values.
- [6] Non-repetitive current pulse, Transmission Line Pulse (TLP)  $t_p = 100\text{ ns}$ ; square pulse; ANS/IESD STM5.1-2008.

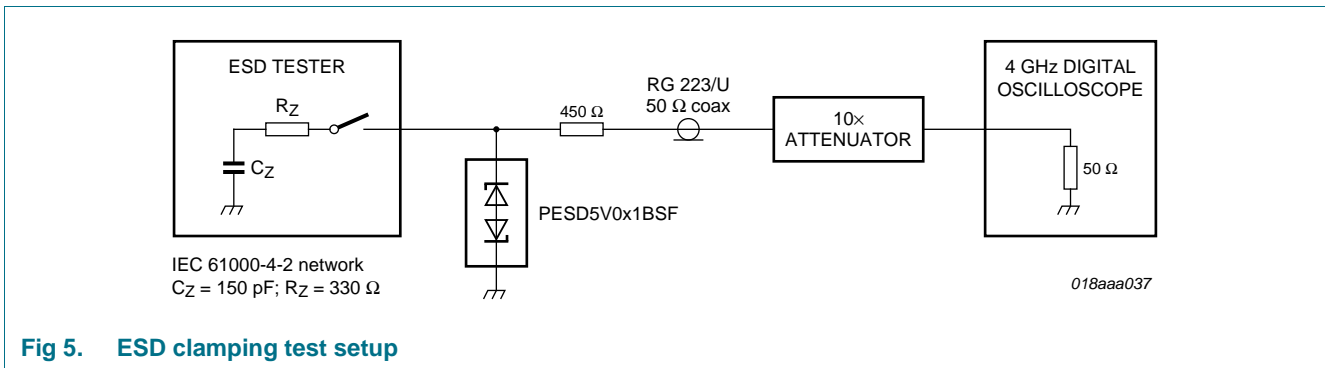
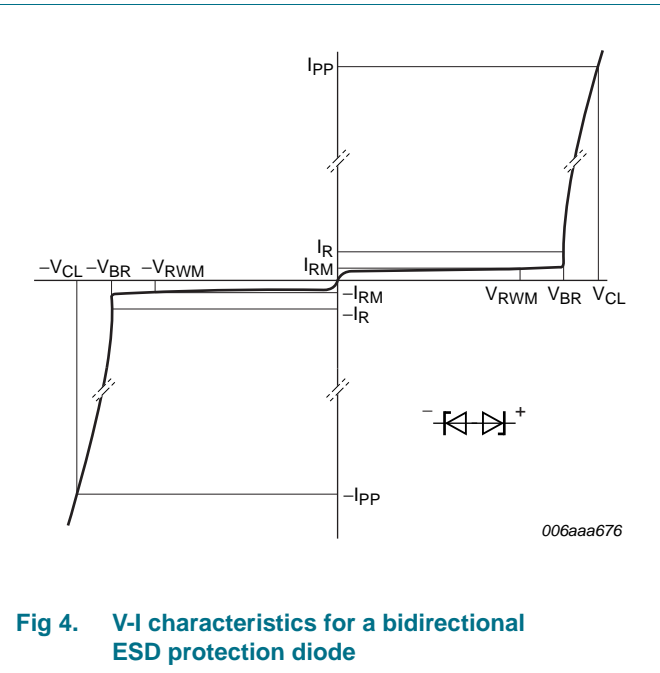
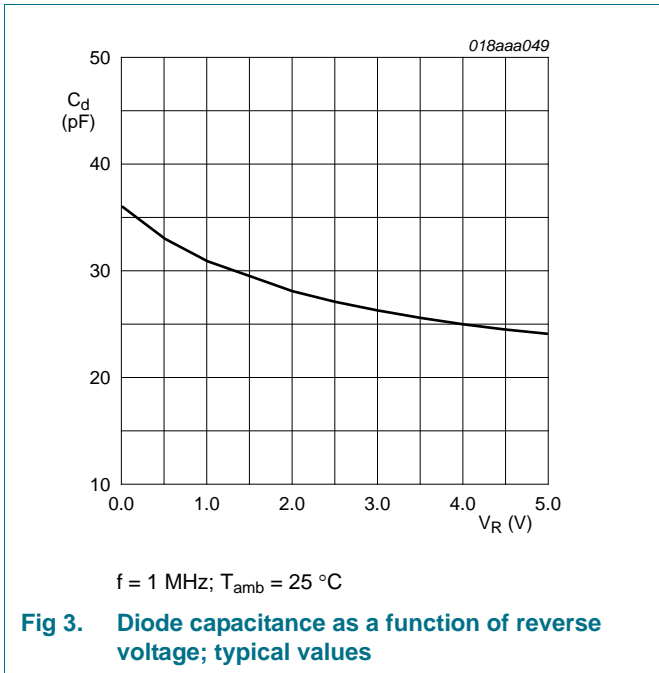

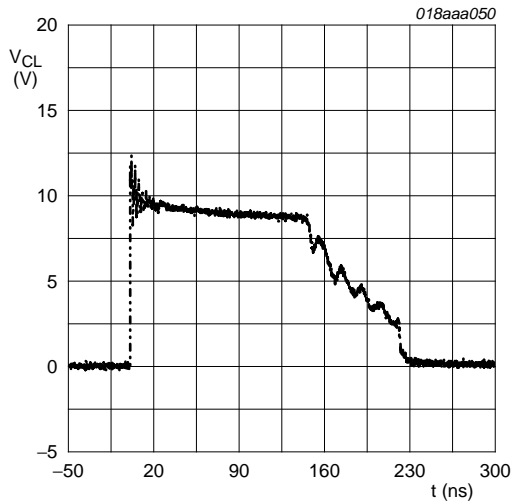

$f = 1 \text{ MHz}; T_{amb} = 25 \text{ }^\circ\text{C}$

**Fig 6. Clamped +1 kV ESD pulse waveform (IEC 61000-4-2 network)**

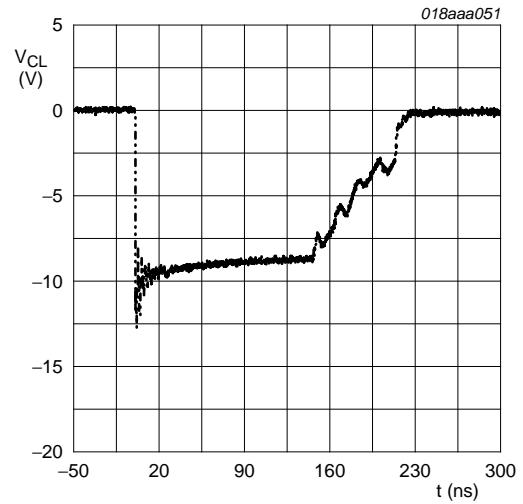

$f = 1 \text{ MHz}; T_{amb} = 25 \text{ }^\circ\text{C}$

**Fig 7. Clamped -1 kV ESD pulse waveform (IEC 61000-4-2 network)**

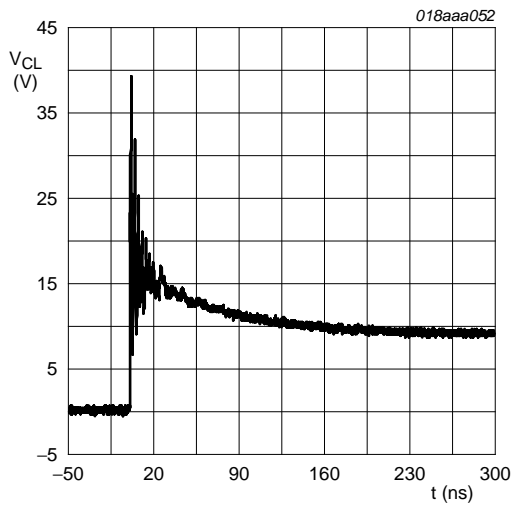

$f = 1 \text{ MHz}; T_{amb} = 25 \text{ }^\circ\text{C}$

**Fig 8. Clamped +8 kV ESD pulse waveform (IEC 61000-4-2 network)**

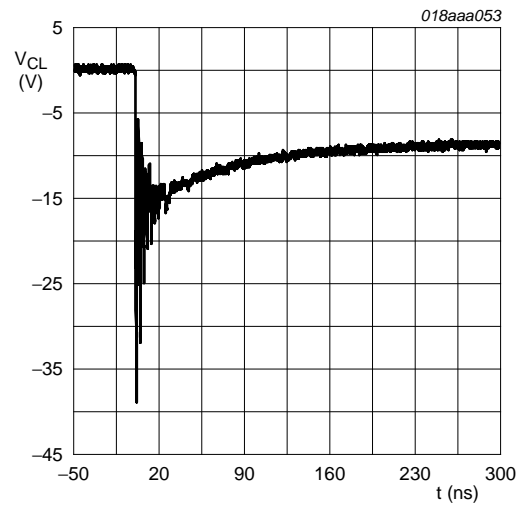

$f = 1 \text{ MHz}; T_{amb} = 25 \text{ }^\circ\text{C}$

**Fig 9. Clamped -8 kV ESD pulse waveform (IEC 61000-4-2 network)**



## 7. Application information

The PESD5V0S1BSF is designed for the protection of one data or signal line from the damage caused by ESD and/or other surge pulses. The device may be used on lines where the signal polarities are both, positive and negative with respect to ground. It provides protection against surges with up to 100 W per line.

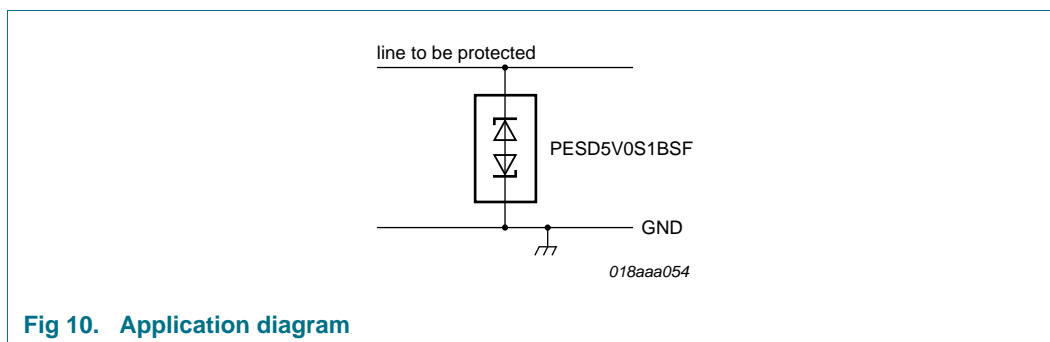

**Fig 10. Application diagram**

### Circuit board layout and protection device placement

Circuit board layout is critical for the suppression of ESD and Electrical Fast Transient (EFT). The following guidelines are recommended:

1. Place the device as close to the input terminal or connector as possible
2. The path length between the device and the protected line should be minimized
3. Avoid running protected conductors in parallel with unprotected conductors
4. Minimize all Printed-Circuit Board (PCB) conductive loops including power and ground loops
5. Minimize the length of the transient return path to ground
6. Avoid using shared transient return paths to a common ground point
7. Ground planes should be used whenever possible. For multilayer PCBs, use ground vias.

## 8. Package outline

Leadless ultra small package; 2 terminals; body 0.6 x 0.3 x 0.3 mm

SOD962

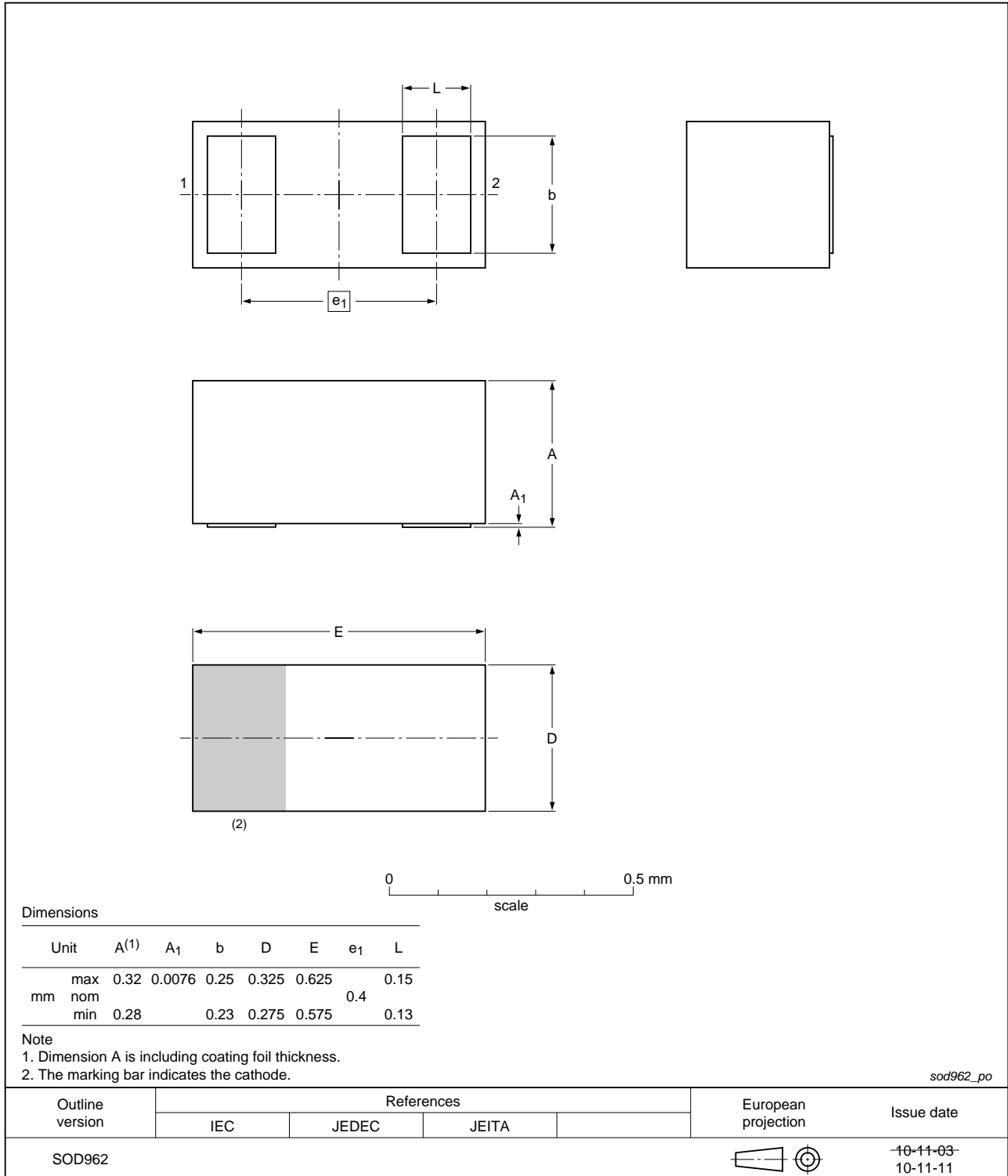

Fig 11. Package outline PESD5V0S1BSF (SOD962)

## 9. Packing information

**Table 9. Packing methods**

The indicated -xxx are the last three digits of the 12NC ordering code.<sup>[1]</sup>

Type number	Package	Description	Packing quantity
			<b>9000</b>
PESD5V0S1BSF	SOD962	2 mm pitch, 8 mm tape and reel	-315

[1] For further information and the availability of packing methods, see [Section 13](#).

## 10. Soldering

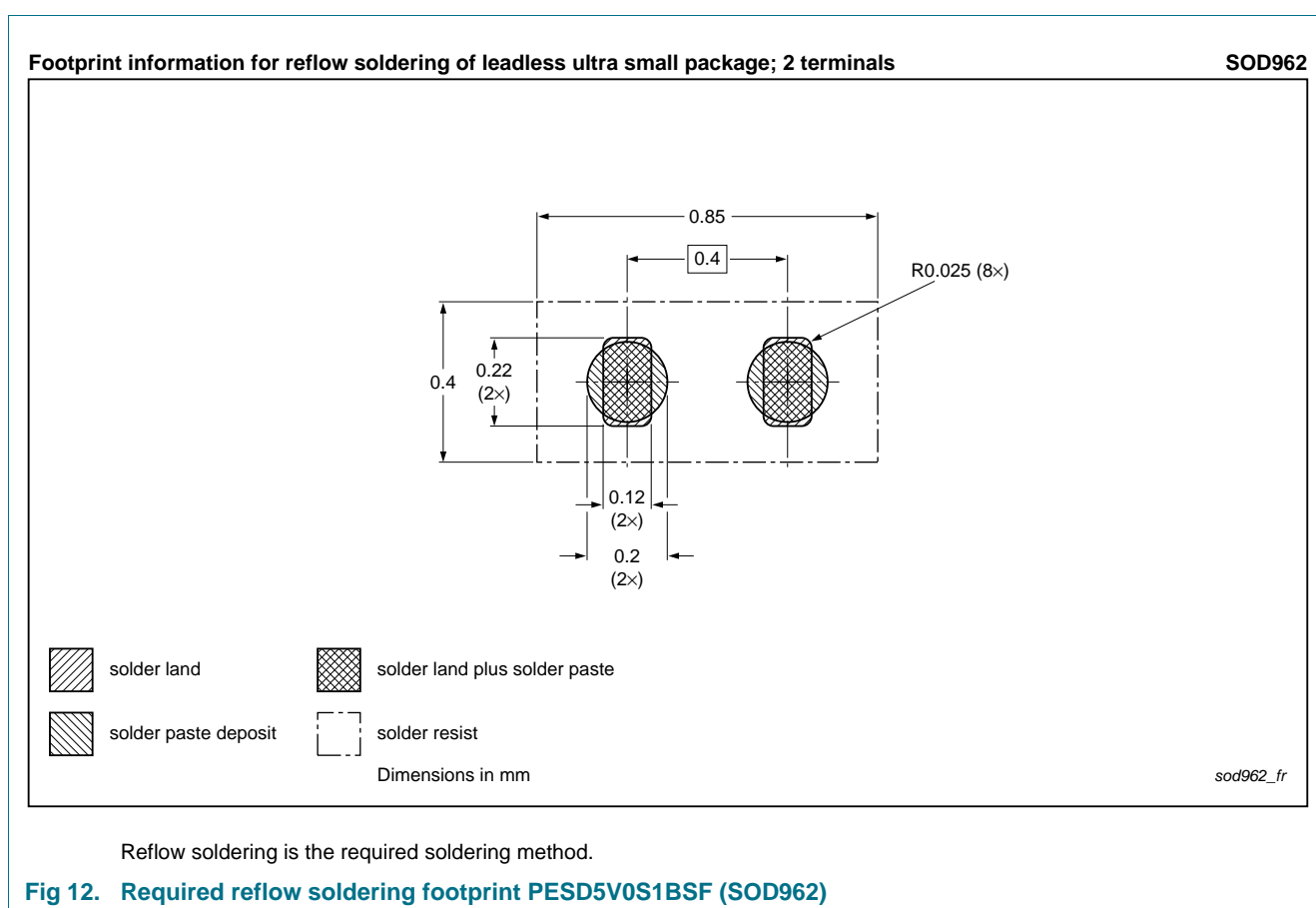

Based on results of board mount testing, Nexperia requires the following soldering guidelines:

1. Soldering footprint as indicated in [Figure 12](#): solder paste has to cover the whole solder land area.
2. Non-solder mask defined (copper-defined) solder lands.
3. Minimum stencil thickness of 100  $\mu\text{m}$ .
4. Paste type 4 or smaller sphere size.
5. Pick and placement accuracy of  $\pm 50 \mu\text{m}$ .

## 11. Revision history

**Table 10. Revision history**

Document ID	Release date	Data sheet status	Change notice	Supersedes
PESD5V0S1BSF v.2	20110218	Product data sheet	-	PESD5V0S1BSF v.1
Modifications:	<ul style="list-style-type: none"> <li>• <a href="#">Section 1.2 “Features and benefits”</a>: updated</li> <li>• <a href="#">Table 1</a> and <a href="#">Table 8</a>: <math>V_{RWM}</math> and <math>C_d</math> values updated.</li> <li>• <a href="#">Table 6 “ESD maximum ratings”</a>: updated.</li> <li>• <a href="#">Table 8</a>: <math>V_{BR}</math> updated.</li> <li>• <a href="#">Figure 12</a>: title amended.</li> </ul>			
PESD5V0S1BSF v.1	20101112	Preliminary data sheet	-	-

## 12. Legal information

### 12.1 Data sheet status

Document status <sup>[1][2]</sup>	Product status <sup>[3]</sup>	Definition
Objective [short] data sheet	Development	This document contains data from the objective specification for product development.
Preliminary [short] data sheet	Qualification	This document contains data from the preliminary specification.
Product [short] data sheet	Production	This document contains the product specification.

[1] Please consult the most recently issued document before initiating or completing a design.

[2] The term 'short data sheet' is explained in section "Definitions".

[3] The product status of device(s) described in this document may have changed since this document was published and may differ in case of multiple devices. The latest product status information is available on the Internet at URL <http://www.nexperia.com>.

### 12.2 Definitions

**Draft** — The document is a draft version only. The content is still under internal review and subject to formal approval, which may result in modifications or additions. Nexperia does not give any representations or warranties as to the accuracy or completeness of information included herein and shall have no liability for the consequences of use of such information.

**Short data sheet** — A short data sheet is an extract from a full data sheet with the same product type number(s) and title. A short data sheet is intended for quick reference only and should not be relied upon to contain detailed and full information. For detailed and full information see the relevant full data sheet, which is available on request via the local Nexperia sales office. In case of any inconsistency or conflict with the short data sheet, the full data sheet shall prevail.

**Product specification** — The information and data provided in a Product data sheet shall define the specification of the product as agreed between Nexperia and its customer, unless Nexperia and customer have explicitly agreed otherwise in writing. In no event however, shall an agreement be valid in which the Nexperia product is deemed to offer functions and qualities beyond those described in the Product data sheet.

malfunction of a Nexperia product can reasonably be expected to result in personal injury, death or severe property or environmental damage. Nexperia accepts no liability for inclusion and/or use of Nexperia products in such equipment or applications and therefore such inclusion and/or use is at the customer's own risk.

**Applications** — Applications that are described herein for any of these products are for illustrative purposes only. Nexperia makes no representation or warranty that such applications will be suitable for the specified use without further testing or modification.

Customers are responsible for the design and operation of their applications and products using Nexperia products, and Nexperia accepts no liability for any assistance with applications or customer product design. It is customer's sole responsibility to determine whether the Nexperia product is suitable and fit for the customer's applications and products planned, as well as for the planned application and use of customer's third party customer(s). Customers should provide appropriate design and operating safeguards to minimize the risks associated with their applications and products.

Nexperia does not accept any liability related to any default, damage, costs or problem which is based on any weakness or default in the customer's applications or products, or the application or use by customer's third party customer(s). Customer is responsible for doing all necessary testing for the customer's applications and products using Nexperia products in order to avoid a default of the applications and the products or of the application or use by customer's third party customer(s). Nexperia does not accept any liability in this respect.

**Limiting values** — Stress above one or more limiting values (as defined in the Absolute Maximum Ratings System of IEC 60134) will cause permanent damage to the device. Limiting values are stress ratings only and (proper) operation of the device at these or any other conditions above those given in the Recommended operating conditions section (if present) or the Characteristics sections of this document is not warranted. Constant or repeated exposure to limiting values will permanently and irreversibly affect the quality and reliability of the device.

**Terms and conditions of commercial sale** — Nexperia products are sold subject to the general terms and conditions of commercial sale, as published at <http://www.nexperia.com/profile/terms>, unless otherwise agreed in a valid written individual agreement. In case an individual agreement is concluded only the terms and conditions of the respective agreement shall apply. Nexperia hereby expressly objects to applying the customer's general terms and conditions with regard to the purchase of Nexperia products by customer.

**No offer to sell or license** — Nothing in this document may be interpreted or construed as an offer to sell products that is open for acceptance or the grant, conveyance or implication of any license under any copyrights, patents or other industrial or intellectual property rights.

**Export control** — This document as well as the item(s) described herein may be subject to export control regulations. Export might require a prior authorization from national authorities.

### 12.3 Disclaimers

**Limited warranty and liability** — Information in this document is believed to be accurate and reliable. However, Nexperia does not give any representations or warranties, expressed or implied, as to the accuracy or completeness of such information and shall have no liability for the consequences of use of such information.

In no event shall Nexperia be liable for any indirect, incidental, punitive, special or consequential damages (including - without limitation - lost profits, lost savings, business interruption, costs related to the removal or replacement of any products or rework charges) whether or not such damages are based on tort (including negligence), warranty, breach of contract or any other legal theory.

Notwithstanding any damages that customer might incur for any reason whatsoever, Nexperia's aggregate and cumulative liability towards customer for the products described herein shall be limited in accordance with the *Terms and conditions of commercial sale* of Nexperia.

**Right to make changes** — Nexperia reserves the right to make changes to information published in this document, including without limitation specifications and product descriptions, at any time and without notice. This document supersedes and replaces all information supplied prior to the publication hereof.

**Suitability for use** — Nexperia products are not designed, authorized or warranted to be suitable for use in life support, life-critical or safety-critical systems or equipment, nor in applications where failure or



**Quick reference data** — The Quick reference data is an extract of the product data given in the Limiting values and Characteristics sections of this document, and as such is not complete, exhaustive or legally binding.

**Non-automotive qualified products** — Unless this data sheet expressly states that this specific Nexperia product is automotive qualified, the product is not suitable for automotive use. It is neither qualified nor tested in accordance with automotive testing or application requirements. Nexperia accepts no liability for inclusion and/or use of non-automotive qualified products in automotive equipment or applications.

In the event that customer uses the product for design-in and use in automotive applications to automotive specifications and standards, customer (a) shall use the product without Nexperia's warranty of the

product for such automotive applications, use and specifications, and (b) whenever customer uses the product for automotive applications beyond Nexperia's specifications such use shall be solely at customer's own risk, and (c) customer fully indemnifies Nexperia for any liability, damages or failed product claims resulting from customer design and use of the product for automotive applications beyond Nexperia's standard warranty and Nexperia's product specifications.

## 12.4 Trademarks

Notice: All referenced brands, product names, service names and trademarks are the property of their respective owners.

## 13. Contact information

For more information, please visit: <http://www.nexperia.com>

For sales office addresses, please send an email to: [salesaddresses@nexperia.com](mailto:salesaddresses@nexperia.com)

## 14. Contents

---

<b>1</b>	<b>Product profile</b> . . . . .	<b>1</b>
1.1	General description . . . . .	1
1.2	Features and benefits . . . . .	1
1.3	Applications . . . . .	1
1.4	Quick reference data . . . . .	1
<b>2</b>	<b>Pinning information</b> . . . . .	<b>2</b>
<b>3</b>	<b>Ordering information</b> . . . . .	<b>2</b>
<b>4</b>	<b>Marking</b> . . . . .	<b>2</b>
<b>5</b>	<b>Limiting values</b> . . . . .	<b>2</b>
<b>6</b>	<b>Characteristics</b> . . . . .	<b>4</b>
<b>7</b>	<b>Application information</b> . . . . .	<b>7</b>
<b>8</b>	<b>Package outline</b> . . . . .	<b>8</b>
<b>9</b>	<b>Packing information</b> . . . . .	<b>9</b>
<b>10</b>	<b>Soldering</b> . . . . .	<b>9</b>
<b>11</b>	<b>Revision history</b> . . . . .	<b>10</b>
<b>12</b>	<b>Legal information</b> . . . . .	<b>11</b>
12.1	Data sheet status . . . . .	11
12.2	Definitions . . . . .	11
12.3	Disclaimers . . . . .	11
12.4	Trademarks . . . . .	12
<b>13</b>	<b>Contact information</b> . . . . .	<b>12</b>
<b>14</b>	<b>Contents</b> . . . . .	<b>13</b>

## OUR CERTIFICATE

DiGi provide top-quality products and perfect service for customer worldwide through standardization, technological innovation and continuous improvement. DiGi through third-party certification, we stricly control the quality of products and services. Welcome your RFQ to

Email: [Info@DiGi-Electronics.com](mailto:Info@DiGi-Electronics.com)



Tel: +00 852-30501935

RFQ Email: [Info@DiGi-Electronics.com](mailto:Info@DiGi-Electronics.com)

DiGi is a global authorized distributor of electronic components.