

UCD0J331MCL6GS Datasheet



<https://www.DiGi-Electronics.com>

DiGi Electronics Part Number	UCD0J331MCL6GS-DG
Manufacturer	Nichicon
Manufacturer Product Number	UCD0J331MCL6GS
Description	CAP ALUM 330UF 20% 6.3V SMD
Detailed Description	330 μ F 6.3 V Aluminum Electrolytic Capacitors Radial, Can - SMD 2000 Hrs @ 105°C

This model UCD0J331MCL6GS is available at DiGi Electronics.

DiGi Electronics offers a global database of semiconductor and electronic component datasheets.

We welcome your inquiries regarding pricing, lead time, or other product-related questions.

 [Request a Quote](#)

 [Datasheet Search](#)



Tel: +00 852-30501935

RFQ Email: Info@DiGi-Electronics.com

DiGi is a global authorized distributor of electronic components.

Purchase and inquiry

Manufacturer Product Number:

UCD0J331MCL6GS

Series:

UCD

Capacitance:

330 μ F

Voltage - Rated:

6.3 V

Lifetime @ Temp.:

2000 Hrs @ 105°C

Polarization:

Polar

Applications:

Automotive

Ripple Current @ High Frequency:

300 mA @ 100 kHz

Lead Spacing:

-

Height - Seated (Max):

0.256" (6.50mm)

Mounting Type:

Surface Mount

Manufacturer:

Nichicon

Product Status:

Active

Tolerance:

\pm 20%

ESR (Equivalent Series Resistance):

-

Operating Temperature:

-55°C ~ 105°C

Ratings:

AEC-Q200

Ripple Current @ Low Frequency:

150 mA @ 120 Hz

Impedance:

260 mOhms

Size / Dimension:

0.315" Dia (8.00mm)

Surface Mount Land Size:

0.327" L x 0.327" W (8.30mm x 8.30mm)

Package / Case:

Radial, Can - SMD

Environmental & Export classification

RoHS Status:

ROHS3 Compliant

REACH Status:

REACH Affected

HTSUS:

8532.22.0020

Moisture Sensitivity Level (MSL):

Not Applicable

ECCN:

EAR99

ALUMINUM ELECTROLYTIC CAPACITORS

UCD Chip Type, Low Impedance



- Chip type, low impedance temperature range up to +105°C.
- Designed for surface mounting on high density PC board.
- Applicable to automatic mounting machine fed with carrier tape.
- Compliant to the RoHS directive (2011/65/EU, (EU)2015/863).
- AEC-Q200 Qualified. Please contact us for details.



Specifications

Item	Performance Characteristics													
Category Temperature Range	- 55 to +105°C													
Rated Voltage Range	6.3 to 100V													
Rated Capacitance Range	1 to 3300µF													
Capacitance Tolerance	±20% at 120Hz, 20°C													
Leakage Current ※	After 2 minutes' application of rated voltage at 20°C, leakage current is not more than 0.01 CV or 3 (µA), whichever is greater.													
Tangent of loss angle (tan δ)	Rated voltage (V)	6.3	10	16	25	35	50	63	80	100	Measurement frequency: 120Hz at 20°C			
	tan δ (max.)	0.26	0.19	0.16	0.14	0.12	0.10	0.08	0.08	0.07				
For capacitance of more than 1000µF, add 0.02 for every increase of 1000µF. (φ12.5 to φ18)														
Stability at Low Temperature	Rated voltage (V)	6.3	10	16	25	35	50	63	80	100	Measurement frequency: 120Hz			
	Impedance ratio (max.)	Z(-25°C) / Z(+20°C)	2	2	2	2	2	2	2	2				
		Z(-40°C) / Z(+20°C)	3	3	3	3	3	3	3	3				
Z(-55°C) / Z(+20°C)	4	4	4	3	3	3	3	3	3					
Endurance	The specifications listed below shall be met when the capacitors are restored to 20°C after the rated voltage is applied at 105°C for the conditions listed at right.		Rated Voltage		Size (mm)		~7.7L		10L		φ10x13.5L		13.5L~	
			6.3~50V				2000hrs.		5000hrs.		5000hrs.		5000hrs.	
			63~100V				2000hrs.		2000hrs.		—		5000hrs.	
	Capacitance Change		Within ± 30% of the initial capacitance value											
tan δ		200% or less than the initial specified value												
Leakage current		300% or less than the initial specified value for 63V or more												
		Less than or equal to the initial specified value												
Shelf Life	After storing the capacitors under no load at 105°C for 1000 hours and then performing voltage treatment based on JIS C 5101-4 clause 4.1 at 20°C, they shall meet the specified values for the endurance characteristics listed above.													
Resistance to soldering heat	The capacitors are kept on a hot plate for 30 seconds, which is maintained at 250°C. The capacitors shall meet the characteristic requirements listed at right when they are removed from the plate and restored to 20°C.		Capacitance Change		Within ± 10% of the initial capacitance value									
			tan δ		Less than or equal to the initial specified value									
			Leakage current		Less than or equal to the initial specified value									
Marking	Black print on the case top.													

Chip Type ※ φ6.3×5.8L or less, φ8×6.2L, φ10×7.7L, φ10×13.5L :
The vibration structure-resistant product can't support.

※ I : Leakage Current (µA), C : Rated Capacitance (µF), V : Rated Voltage (V)

(φ4 to φ8 × 6.2)

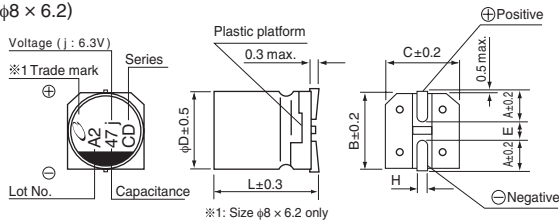

(φ8 × 10, φ10)

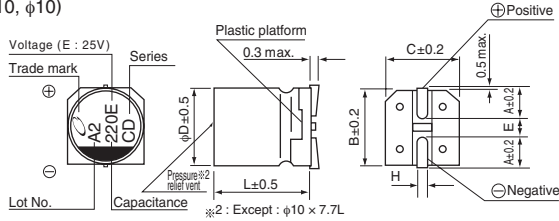

(φ12.5 to φ18)

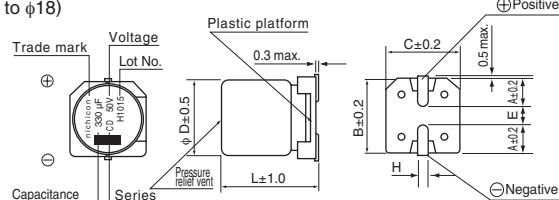

(φ6.3) 【Vibration Resistance】

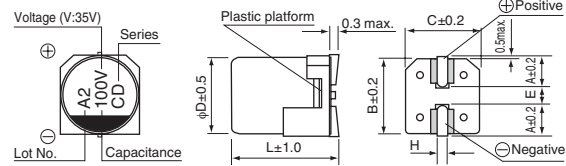

(φ8, φ10) 【Vibration Resistance】

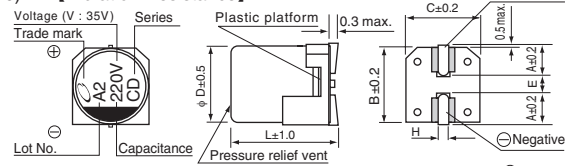

(φ12.5 to φ18) 【Vibration Resistance】

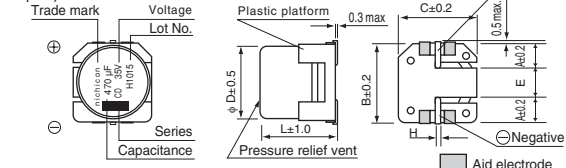

Type numbering system (Example : 16V 100µF)

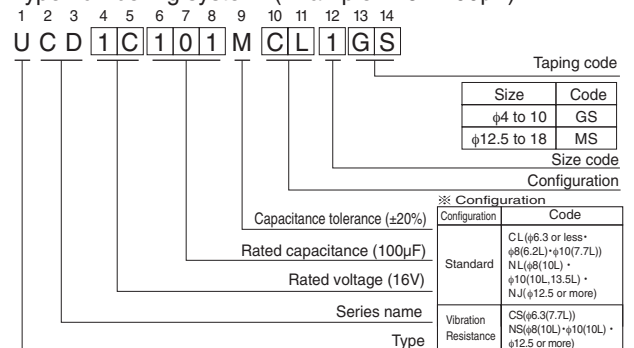

Standard	(mm)																Vibration Resistance				(mm)			
φD×L	4×5.8	5×5.8	6.3×5.8	6.3×7.7	8×6.2	8×10	10×7.7	10×10	10×13.5	10×13.5	12.5×13.5	16×16.5	16×16.5	φ4	φ6.3	φ7.7	φ10	φ12.5	φ16	φ18				
A	1.8	2.1	2.4	2.4	3.3	2.9	3.2	3.2	3.2	5.15	5.65	6.65		A	2.4	2.9	3.2	4.8	5.4	6.4				
B	4.3	5.3	6.6	6.6	8.3	8.3	10.3	10.3	10.3	13.6	17.1	19.1		B	6.6	8.3	10.3	13.6	17.1	19.1				
C	4.3	5.3	6.6	6.6	8.3	8.3	10.3	10.3	10.3	13.6	17.1	19.1		C	6.6	8.3	10.3	13.6	17.1	19.1				
E	10	1.3	2.2	2.2	3.1	4.5	4.5	4.5	4.5	(3.3)	(5.8)	(5.8)		E	2.2	3.1	4.5	(4.0)	(6.3)	(6.3)				
H	5.8	5.8	5.8	7.7	6.2	10	7.7	10	13.5	13.5	16.5	16.5		L	7.7	10	10	13.5	16.5	16.5				
L	0.5 to 0.8	0.5 to 0.8	0.5 to 0.8	0.5 to 0.8	0.5 to 0.8	0.8 to 1.1	0.8 to 1.1	0.8 to 1.1	0.8 to 1.1	1.0 to 1.4	1.0 to 1.4	1.0 to 1.4		H	0.5 to 0.8	1.1 to 1.5	1.1 to 1.5	1.1 to 1.5	1.1 to 1.5	1.0 to 1.4	1.0 to 1.4			

Voltage		Frequency coefficient of rated ripple current													
V	6.3	10	16	25	35	50	63	80	100	Frequency	50Hz	120Hz	300Hz	1kHz	10kHz or more
Code	J	A	C	E	V	H	J	K	2A	Coefficient	0.35	0.50	0.64	0.83	1.00

● Dimension table in next page.

ALUMINUM ELECTROLYTIC CAPACITORS

UCD

■ Dimensions

Rated Voltage (V) (code)	Rated Capacitance (μF)	Case Size φD×L (mm)	tan δ	Leakage Current (μA) (at 20°C after 2 minutes)	Impedance (Ω) max. (20°C/100kHz)	Rated Ripple (mA rms) (105°C/100kHz)	Part Number
6.3 (0J)	22	4×5.8	0.26	3	1.35	90	UCD0J220MCL1GS
	27	4×5.8	0.26	3	1.35	90	UCD0J270MCL1GS
	33	5×5.8	0.26	3	0.70	160	UCD0J330MCL1GS
	47	4×5.8	0.26	3	1.35	90	UCD0J470MCL6GS
	47	5×5.8	0.26	3	0.70	160	UCD0J470MCL1GS
	56	5×5.8	0.26	3.528	0.70	160	UCD0J560MCL1GS
	68	6.3×5.8	0.26	4.284	0.36	240	UCD0J680MCL1GS
	100	5×5.8	0.26	6.3	0.70	160	UCD0J101MCL6GS
	100	6.3×5.8	0.26	6.3	0.36	240	UCD0J101MCL1GS
	150	6.3×5.8	0.26	9.45	0.36	240	UCD0J151MCL1GS
	220	6.3×5.8	0.26	13.86	0.36	240	UCD0J221MCL1GS
	330	6.3×7.7	0.26	20.79	0.32	290	UCD0J331M□□1GS
	330	8×6.2	0.26	20.79	0.26	300	UCD0J331MCL6GS
	470	8×10	0.26	29.61	0.16	600	UCD0J471M□□1GS
	470	10×7.7	0.26	29.61	0.18	600	UCD0J471MCL6GS
	680	8×10	0.26	42.84	0.16	600	UCD0J681M□□1GS
	680	10×7.7	0.26	42.84	0.18	600	UCD0J681MCL6GS
	1000	8×10	0.26	63	0.16	600	UCD0J102M□□1GS
	1500	10×10	0.26	94.5	0.080	850	UCD0J152M□□1GS
2200	10×13.5	0.26	138.6	0.080	950	UCD0J222MNL1GS	
3300	12.5×13.5	0.30	207.9	0.080	1100	UCD0J332M□□1MS	
10 (1A)	22	4×5.8	0.19	3	1.35	90	UCD1A220MCL1GS
	27	5×5.8	0.19	3	0.70	160	UCD1A270MCL1GS
	33	4×5.8	0.19	3.3	1.35	90	UCD1A330MCL6GS
	33	5×5.8	0.19	3.3	0.70	160	UCD1A330MCL1GS
	47	6.3×5.8	0.19	4.7	0.36	240	UCD1A470MCL1GS
	56	6.3×5.8	0.19	5.6	0.36	240	UCD1A560MCL1GS
	68	6.3×5.8	0.19	6.8	0.36	240	UCD1A680MCL1GS
	100	6.3×5.8	0.19	10	0.36	240	UCD1A101MCL1GS
	150	6.3×5.8	0.19	15	0.36	240	UCD1A151MCL1GS
	220	6.3×7.7	0.19	22	0.32	290	UCD1A221M□□1GS
	220	8×6.2	0.19	22	0.26	300	UCD1A221MCL6GS
	330	8×10	0.19	33	0.16	600	UCD1A331M□□1GS
	330	10×7.7	0.19	33	0.18	600	UCD1A331MCL6GS
	470	8×10	0.19	47	0.16	600	UCD1A471M□□1GS
	470	10×7.7	0.19	47	0.18	600	UCD1A471MCL6GS
	680	10×10	0.19	68	0.080	850	UCD1A681M□□1GS
	1000	10×10	0.19	100	0.080	850	UCD1A102M□□1GS
	1500	10×13.5	0.19	150	0.080	950	UCD1A152MNL1GS
	2200	12.5×13.5	0.21	220	0.080	1100	UCD1A222M□□1MS
16 (1C)	10	4×5.8	0.16	3	1.35	90	UCD1C100MCL1GS
	15	4×5.8	0.16	3	1.35	90	UCD1C150MCL1GS
	22	4×5.8	0.16	3.52	1.35	90	UCD1C220MCL6GS
	22	5×5.8	0.16	3.52	0.70	160	UCD1C220MCL1GS
	27	5×5.8	0.16	4.32	0.70	160	UCD1C270MCL1GS
	33	6.3×5.8	0.16	5.28	0.36	240	UCD1C330MCL1GS
	47	5×5.8	0.16	7.52	0.70	160	UCD1C470MCL6GS
	47	6.3×5.8	0.16	7.52	0.36	240	UCD1C470MCL1GS
	56	6.3×5.8	0.16	8.96	0.36	240	UCD1C560MCL1GS
	68	6.3×5.8	0.16	10.88	0.36	240	UCD1C680MCL1GS
	100	6.3×5.8	0.16	16	0.36	240	UCD1C101MCL1GS

□□ : Enter the appropriate configuration code.

ALUMINUM ELECTROLYTIC CAPACITORS

UCD

■ Dimensions

Rated Voltage (V) (code)	Rated Capacitance (μF)	Case Size φD×L (mm)	tan δ	Leakage Current (μA) (at 20°C after 2 minutes)	Impedance (Ω) max. (20°C/100kHz)	Rated Ripple (mArms) (105°C/100kHz)	Part Number
16 (1C)	150	6.3×7.7	0.16	24	0.32	290	UCD1C151M□□1GS
	220	6.3×7.7	0.16	35.2	0.32	290	UCD1C221M□□1GS
	220	8×6.2	0.16	35.2	0.26	300	UCD1C221MCL6GS
	330	8×10	0.16	52.8	0.16	600	UCD1C331M□□1GS
	330	10×7.7	0.16	52.8	0.18	600	UCD1C331MCL6GS
	470	8×10	0.16	75.2	0.16	600	UCD1C471M□□1GS
	470	10×7.7	0.16	75.2	0.18	600	UCD1C471MCL6GS
	680	10×10	0.16	108.8	0.080	850	UCD1C681M□□1GS
	1000	10×13.5	0.16	160	0.080	950	UCD1C102MNL1GS
	1500	12.5×13.5	0.16	240	0.080	1100	UCD1C152M□□1MS
25 (1E)	10	4×5.8	0.14	3	1.35	90	UCD1E100MCL1GS
	15	5×5.8	0.14	3.75	0.70	160	UCD1E150MCL1GS
	22	5×5.8	0.14	5.5	0.70	160	UCD1E220MCL1GS
	27	6.3×5.8	0.14	6.75	0.36	240	UCD1E270MCL1GS
	33	5×5.8	0.14	8.25	0.70	160	UCD1E330MCL6GS
	33	6.3×5.8	0.14	8.25	0.36	240	UCD1E330MCL1GS
	47	6.3×5.8	0.14	11.75	0.36	240	UCD1E470MCL1GS
	56	6.3×5.8	0.14	14	0.36	240	UCD1E560MCL1GS
	68	6.3×5.8	0.14	17	0.36	240	UCD1E680MCL1GS
	100	6.3×7.7	0.14	25	0.32	290	UCD1E101M□□1GS
	100	8×6.2	0.14	25	0.26	300	UCD1E101MCL6GS
	150	8×10	0.14	37.5	0.16	600	UCD1E151M□□1GS
	150	10×7.7	0.14	37.5	0.18	600	UCD1E151MCL6GS
	220	8×10	0.14	55	0.16	600	UCD1E221M□□1GS
	220	10×7.7	0.14	55	0.18	600	UCD1E221MCL6GS
	330	8×10	0.14	82.5	0.16	600	UCD1E331M□□1GS
	470	10×10	0.14	117.5	0.080	850	UCD1E471M□□1GS
	680	10×13.5	0.14	170	0.080	950	UCD1E681MNL1GS
	1000	12.5×13.5	0.14	250	0.080	1100	UCD1E102M□□1MS
	2200	16×16.5	0.16	550	0.035	1800	UCD1E222M□□1MS
35 (1V)	4.7	4×5.8	0.12	3	1.35	90	UCD1V47R7MCL1GS
	10	4×5.8	0.12	3.5	1.35	90	UCD1V100MCL6GS
	10	5×5.8	0.12	3.5	0.70	160	UCD1V100MCL1GS
	22	5×5.8	0.12	7.7	0.70	160	UCD1V220MCL1GS
	33	6.3×5.8	0.12	11.55	0.36	240	UCD1V330MCL1GS
	47	6.3×5.8	0.12	16.45	0.36	240	UCD1V470MCL1GS
	68	6.3×7.7	0.12	23.8	0.32	290	UCD1V680M□□1GS
	100	6.3×7.7	0.12	35	0.32	290	UCD1V101M□□6GS
	100	8×10	0.12	35	0.16	600	UCD1V101M□□1GS
	150	8×10	0.12	52.5	0.16	600	UCD1V151M□□1GS
	150	10×7.7	0.12	52.5	0.18	600	UCD1V151MCL6GS
	220	8×10	0.12	77	0.16	600	UCD1V221M□□1GS
	220	10×7.7	0.12	77	0.18	600	UCD1V221MCL6GS
	330	10×10	0.12	115.5	0.080	850	UCD1V331M□□1GS
	470	10×13.5	0.12	164.5	0.080	950	UCD1V471MNL6GS
	470	12.5×13.5	0.12	164.5	0.080	1100	UCD1V471M□□1MS
	680	12.5×13.5	0.12	238	0.080	1100	UCD1V681M□□1MS
	1000	16×16.5	0.12	350	0.035	1800	UCD1V102M□□1MS
50 (1H)	1	4×5.8	0.10	3	2.70	60	UCD1H010MCL1GS
	2.2	4×5.8	0.10	3	2.70	60	UCD1H2R2MCL1GS
	3.3	4×5.8	0.10	3	2.70	60	UCD1H3R3MCL1GS

□□ : Enter the appropriate configuration code.

ALUMINUM ELECTROLYTIC CAPACITORS

UCD

■ Dimensions

Rated Voltage (V) (code)	Rated Capacitance (μF)	Case Size φD×L (mm)	tan δ	Leakage Current (μA) (at 20°C after 2 minutes)	Impedance (Ω) max. (20°C/100kHz)	Rated Ripple (mArms) (105°C/100kHz)	Part Number
50 (1H)	4.7	4×5.8	0.10	3	2.70	60	UCD1H4R7MCL1GS
	10	5×5.8	0.10	5	1.50	90	UCD1H100MCL6GS
	10	6.3×5.8	0.10	5	0.86	170	UCD1H100MCL1GS
	22	6.3×5.8	0.10	11	0.86	170	UCD1H220MCL1GS
	33	6.3×7.7	0.10	16.5	0.66	195	UCD1H330M□□1GS
	33	8×6.2	0.10	16.5	0.63	200	UCD1H330MCL6GS
	47	6.3×7.7	0.10	23.5	0.66	195	UCD1H470M□□1GS
	47	8×6.2	0.10	23.5	0.63	200	UCD1H470MCL6GS
	100	8×10	0.10	50	0.32	350	UCD1H101M□□1GS
	100	10×7.7	0.10	50	0.36	330	UCD1H101MCL6GS
	150	10×10	0.10	75	0.16	700	UCD1H151M□□1GS
	220	10×10	0.10	110	0.16	700	UCD1H221M□□1GS
	330	10×13.5	0.10	165	0.14	800	UCD1H331MNL6GS
	330	12.5×13.5	0.10	165	0.12	900	UCD1H331M□□1MS
390	12.5×13.5	0.10	195	0.12	900	UCD1H391M□□1MS	
470	16×16.5	0.10	235	0.073	1610	UCD1H471M□□1MS	
680	16×16.5	0.10	340	0.073	1610	UCD1H681M□□1MS	
63 (1J)	4.7	5×5.8	0.08	3	3.00	50	UCD1J4R7MCL1GS
	10	6.3×5.8	0.08	6.3	1.50	80	UCD1J100MCL1GS
	22	6.3×7.7	0.08	13.86	1.20	120	UCD1J220M□□1GS
	22	8×6.2	0.08	13.86	1.20	120	UCD1J220MCL6GS
	33	8×10	0.08	20.79	0.65	250	UCD1J330M□□1GS
	47	8×10	0.08	29.61	0.65	250	UCD1J470M□□1GS
	68	10×10	0.08	42.84	0.35	400	UCD1J680M□□1GS
	100	10×10	0.08	63	0.35	400	UCD1J101M□□1GS
	150	12.5×13.5	0.08	94.5	0.16	800	UCD1J151M□□1MS
	220	12.5×13.5	0.08	138.6	0.16	800	UCD1J221M□□1MS
	470	16×16.5	0.08	296.1	0.082	1410	UCD1J471M□□1MS
680	18×16.5	0.08	428.4	0.080	1690	UCD1J681M□□1MS	
80 (1K)	3.3	5×5.8	0.08	3	5.00	25	UCD1K3R3MCL1GS
	4.7	6.3×5.8	0.08	3.76	3.00	40	UCD1K4R7MCL1GS
	10	6.3×7.7	0.08	8	2.40	60	UCD1K100M□□1GS
	10	8×6.2	0.08	8	2.40	60	UCD1K100MCL6GS
	22	8×10	0.08	17.6	1.30	130	UCD1K220M□□1GS
	33	8×10	0.08	26.4	1.30	130	UCD1K330M□□1GS
	47	10×10	0.08	37.6	0.70	200	UCD1K470M□□1GS
	68	12.5×13.5	0.08	54.4	0.32	500	UCD1K680M□□1MS
	100	12.5×13.5	0.08	80	0.32	500	UCD1K101M□□1MS
	150	12.5×13.5	0.08	120	0.32	500	UCD1K151M□□1MS
	330	16×16.5	0.08	264	0.17	793	UCD1K331M□□1MS
470	18×16.5	0.08	376	0.15	917	UCD1K471M□□1MS	
100 (2A)	22	8×10	0.07	22	1.30	130	UCD2A220M□□1GS
	33	10×10	0.07	33	0.70	200	UCD2A330M□□1GS
	47	12.5×13.5	0.07	47	0.32	500	UCD2A470M□□1MS
	68	12.5×13.5	0.07	68	0.32	500	UCD2A680M□□1MS
	100	16×16.5	0.07	100	0.17	793	UCD2A101M□□1MS
	150	16×16.5	0.07	150	0.17	793	UCD2A151M□□1MS
	220	18×16.5	0.07	220	0.15	917	UCD2A221M□□1MS
	330	18×16.5	0.07	330	0.15	917	UCD2A331M□□1MS

□□ : Enter the appropriate configuration code.

- For taping specifications, recommended land size/soldering by reflow and minimum order quantity, please refer to the Guidelines for Aluminum Electrolytic Capacitors.

OUR CERTIFICATE

DiGi provide top-quality products and perfect service for customer worldwide through standardization, technological innovation and continuous improvement. DiGi through third-party certification, we stricy control the quality of products and services. Welcome your RFQ to

Email: Info@DiGi-Electronics.com



Tel: +00 852-30501935

RFQ Email: Info@DiGi-Electronics.com

DiGi is a global authorized distributor of electronic components.