

UB215KKG01CF-3JB Datasheet



| | |
|------------------------------|---|
| DiGi Electronics Part Number | UB215KKG01CF-3JB-DG |
| Manufacturer | NKK Switches |
| Manufacturer Product Number | UB215KKG01CF-3JB |
| Description | SWITCH PUSH SPDT 0.4VA 28V |
| Detailed Description | Pushbutton Switch SPDT Standard, Illuminated Panel Mount, Snap-In |

<https://www.DiGi-Electronics.com>

This model UB215KKG01CF-3JB is available at DiGi Electronics.

DiGi Electronics offers a global database of semiconductor and electronic component datasheets.

We welcome your inquiries regarding pricing, lead time, or other product-related questions.

 [Request a Quote](#)

 [Datasheet Search](#)



Tel: +00 852-30501935

RFQ Email: Info@DiGi-Electronics.com

DiGi is a global authorized distributor of electronic components.

Purchase and inquiry

Manufacturer Product Number:

UB215KKG01CF-3JB

Series:

UB2

Mounting Type:

Panel Mount, Snap-In

Circuit:

SPDT

Current Rating (Amps):

0.4VA (AC/DC)

Voltage Rating - DC:

28 V

Actuator Marking:

No Marking

Illumination Type, Color:

LED, Green/Red

Termination Style:

Solder Lug

Features:

Pulse 300 ms

Operating Temperature:

-25°C ~ 50°C

Electrical Life:

200,000 Cycles

Manufacturer:

NKK Switches

Product Status:

Obsolete

Type:

Standard, Illuminated

Switch Function:

On-Mom

Voltage Rating - AC:

28 V

Actuator Type:

Square, Button

Color - Actuator/Cap:

Clear (White Filter/Diffuser)

Illumination Voltage (Nominal):

2.1, 3.5 VDC

Ingress Protection:

-

Panel Cutout Dimensions:

Square - 17.40mm x 17.40mm

Mechanical Life:

1,000,000 Cycles

Environmental & Export classification

Moisture Sensitivity Level (MSL):

1 (Unlimited)

ECCN:

EAR99

REACH Status:

REACH Unaffected

HTSUS:

8536.50.9031

General Specifications

Toggles

Rockers

Pushbuttons

Illuminated PB

Programmable

Keylocks

Rotaries

Slides

Tactiles

Tilt

Touch

Indicators

Accessories

Supplement

Electrical Capacity (Resistive Load)

- Power Level (silver):** 5A @ 125/250V AC or 5A @ 30V DC
Logic Level (gold): 0.4VA maximum @ 28V AC/DC maximum
 (Applicable Range 0.1mA ~ 0.1A @ 20mV ~ 28V)
 Note: Find additional explanation of operating range in Supplement section.

Other Ratings

- Contact Resistance:** 50 milliohms maximum for silver; 100 milliohms maximum for gold
Insulation Resistance: 200 megohms minimum @ 500V DC
Dielectric Strength: 1,000V AC minimum between contacts for 1 minute minimum;
 1,500V AC minimum between contacts & case for 1 minute minimum
Mechanical Life: 1,000,000 operations minimum for momentary;
 200,000 operations minimum for alternate action
Electrical Life: 10,000 operations minimum for silver;
 200,000 operations minimum for gold
Nominal Operating Force: Single Pole: 1.90N
 Double Pole: 2.55N
Contact Timing: Break before make
Travel: Pretravel .067" (1.7mm); Overtravel .024" (0.6mm); Total Travel .091" (2.3mm)

Materials & Finishes

- Housing/Bezel:** Glass fiber reinforced polyamide (UL94V-0)
Snap-in Frame: Stainless steel
Movable Contact: Phosphor bronze
Movable Contacts: Silver alloy or copper with gold plating
Stationary Contacts: Silver alloy or copper with gold plating
Switch Terminals: Phosphor bronze with silver or gold plating
Lamp Terminals: Brass with tin plating
Base: Glass fiber reinforced liquid crystal polymer (UL94V-0)

Environmental Data

- Operating Temperature Range:** -25°C through +50°C (-13°F through +122°F) for Illuminated
 -25°C through +70°C (-13°F through +158°F) for Nonilluminated
Humidity: 90 ~ 95% humidity for 240 hours @ 40°C (104°F)
Vibration: 10 ~ 55Hz with peak-to-peak amplitude of 1.5mm traversing the frequency range & returning in 1 minute; 3 right angled directions for 2 hours
Shock: 50G (490m/s²) acceleration (tested in 6 right angled directions, with 5 shocks in each direction)

Installation

- Cap Installation Force:** 15.0N maximum downward force on cap

Processing

- Soldering:** Wave Soldering (PC version): See Profile A in Supplement section.
 Manual Soldering: See Profile A in Supplement section.
Cleaning: These devices are not process sealed. Hand clean locally using alcohol based solution.

Standards & Certifications

- Flammability Standards:** UL94V-0 housing/bezel & base
UL: **File No. E44145 - Recognized only when ordered with marking on switch.**
 Add "/U" or "/CUL" before dash in part number to order UL recognized switch.
 UL recognized only when ordered switch body with cap assembled.
 All single & double pole models recognized at 5A @ 125/250V AC or 0.014A @ 28V DC.

Distinctive Characteristics

Wide selection of illumination effects is achieved with single and bicolor, 1- or 6-element LEDs in flat, beveled, or sculptured caps.

Alternating legends in choice of sculptured or flat caps, combined with super bright bicolor LED.

Combination of PCB mountability and short body allows use in compact applications.

Small behind panel dimension for snap-in mounting in tight spaces.

Snap-acting contact mechanism provides sensitive actuation with audible feedback; quick-make, quick-break characteristic limits arcing and prolongs electrical life.

Latchdown mechanism, independent of switching mechanism, gives outstanding stability and reliability plus visible and tactile indication of circuit status.

Terminals are epoxy sealed to lock out flux, solvents, and other contaminants.

Momentary and alternate action circuits available in the same space-saving body size.

Matching indicators available.

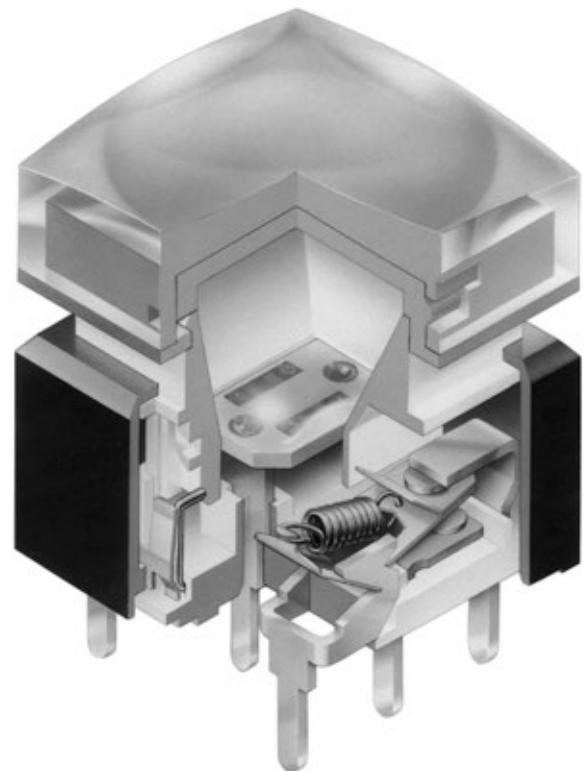

Actual Size

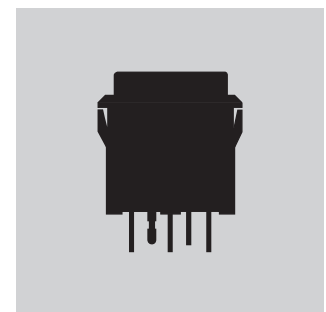

Toggles

Rockers

Pushbuttons

D
Illuminated PB

Programmable

Keylocks

Rotaries

Slides

Tactiles

Tilt

Touch

Indicators

Accessories

Supplement

Series UB2

Low Profile Pushbuttons

TYPICAL SWITCH

UB2

1

5

SK

G

03

| Poles | |
|-------|------|
| 1 | SPDT |
| 2 | DPDT |

| Circuits | | |
|---------------------------------|----|------|
| 5 | ON | (ON) |
| () = Momentary | | |
| 6 | ON | ON |
| Alternate Action with Latchdown | | |

| Mounting Types | |
|--------------------------------------|--------|
| PCB Mounting | |
| SK | Square |
| * Snap-in Mounting | |
| KK | Square |
| * Standard with Solder Lug terminals | |

| Terminals | |
|-----------|-----------------------------------|
| 01 | Solder Lug (for Snap-in Mounting) |
| 03 | Straight PC |

| Contacts & Ratings | |
|--------------------|--------------------------------------|
| W | Silver Rated 5A @ 125/250V AC |
| G | Gold Rated 0.4VA max @ 28V AC/DC max |

| Part Numbers for Alternating Legends | | |
|--------------------------------------|----------------------------|---------------------------|
| Color | 15mm Square Sculptured Cap | 15mm Square Flat Cap |
| | Part Number | Part Number |
| Red/Green | AT3069JCF11 ~ AT3069JCF14 | AT3070JCF11 ~ AT3070JCF14 |
| Amber/Blue | AT3069JDG11 ~ AT3069JDG14 | AT3070JDG11 ~ AT3070JDG14 |

Refer to Ordering Table for Alternating Legend that corresponds with last 2 digits of part number.

IMPORTANT:



Switches are supplied without UL & cULus marking unless specified. **UL & cULus recognized only when ordered with marking on switch.** Specific models, ratings, & ordering instructions are noted on the General Specifications page.

DESCRIPTION FOR TYPICAL ORDERING EXAMPLE

UB215SKG035C-1JC



Toggles
 Rockers
 Pushbuttons
Illuminated PB
 Programmable
 Keylocks
 Rotaries
 Slides
 Tactiles
 Tilt
 Touch
 Indicators
 Accessories
 Supplement

Low Profile Pushbuttons

Series UB2

ORDERING EXAMPLE

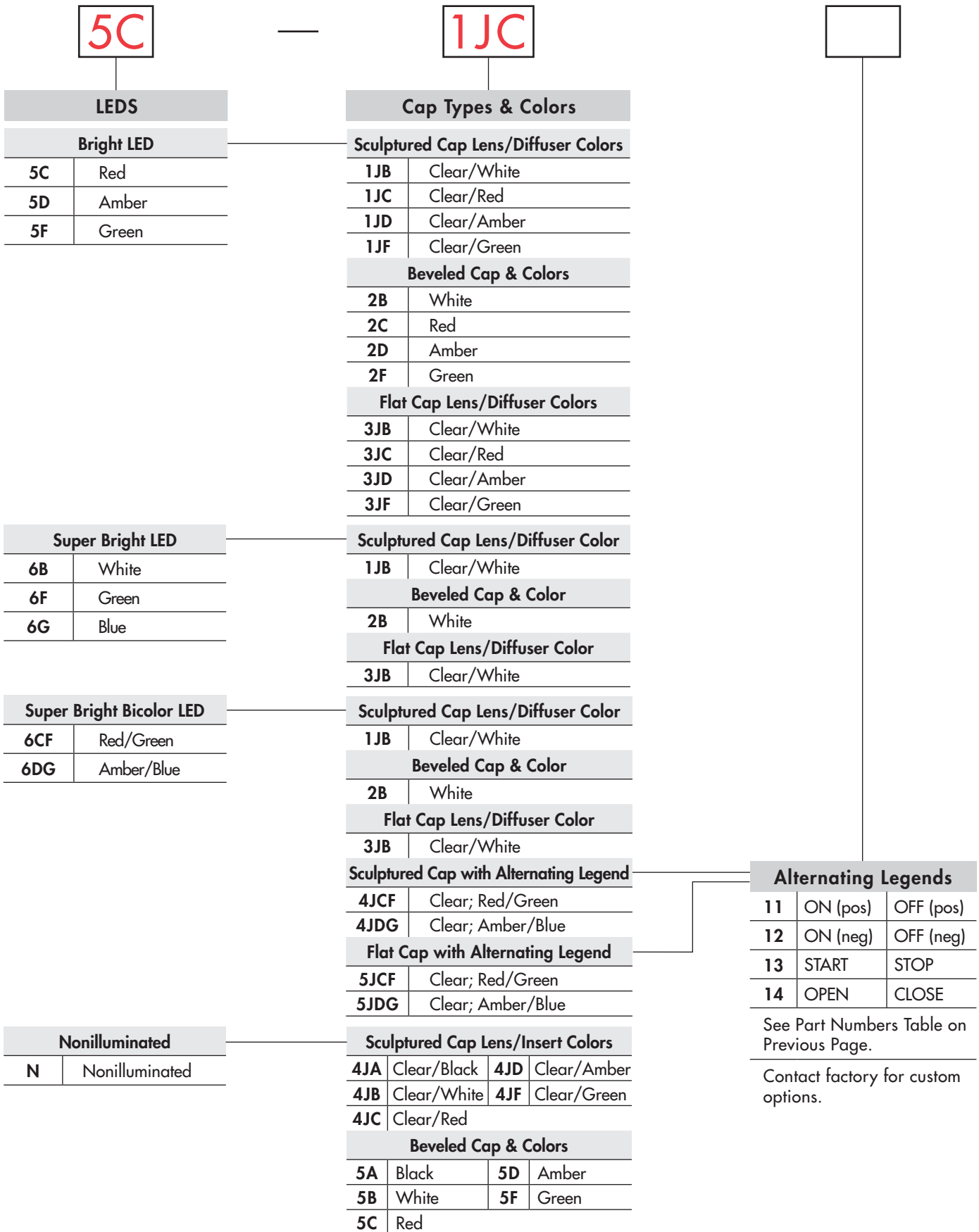

5C

| LEDS | |
|------------|-------|
| Bright LED | |
| 5C | Red |
| 5D | Amber |
| 5F | Green |

| Super Bright LED | |
|------------------|-------|
| 6B | White |
| 6F | Green |
| 6G | Blue |

| Super Bright Bicolor LED | |
|--------------------------|------------|
| 6CF | Red/Green |
| 6DG | Amber/Blue |

| Nonilluminated | |
|----------------|----------------|
| N | Nonilluminated |

1JC

| Cap Types & Colors | | | |
|--|-------------------|-----|-------------|
| Sculptured Cap Lens/Diffuser Colors | | | |
| 1JB | Clear/White | | |
| 1JC | Clear/Red | | |
| 1JD | Clear/Amber | | |
| 1JF | Clear/Green | | |
| Beveled Cap & Colors | | | |
| 2B | White | | |
| 2C | Red | | |
| 2D | Amber | | |
| 2F | Green | | |
| Flat Cap Lens/Diffuser Colors | | | |
| 3JB | Clear/White | | |
| 3JC | Clear/Red | | |
| 3JD | Clear/Amber | | |
| 3JF | Clear/Green | | |
| Sculptured Cap Lens/Diffuser Color | | | |
| 1JB | Clear/White | | |
| Beveled Cap & Color | | | |
| 2B | White | | |
| Flat Cap Lens/Diffuser Color | | | |
| 3JB | Clear/White | | |
| Sculptured Cap Lens/Diffuser Color | | | |
| 1JB | Clear/White | | |
| Beveled Cap & Color | | | |
| 2B | White | | |
| Flat Cap Lens/Diffuser Color | | | |
| 3JB | Clear/White | | |
| Sculptured Cap with Alternating Legend | | | |
| 4JCF | Clear; Red/Green | | |
| 4JDG | Clear; Amber/Blue | | |
| Flat Cap with Alternating Legend | | | |
| 5JCF | Clear; Red/Green | | |
| 5JDG | Clear; Amber/Blue | | |
| Sculptured Cap Lens/Insert Colors | | | |
| 4JA | Clear/Black | 4JD | Clear/Amber |
| 4JB | Clear/White | 4JF | Clear/Green |
| 4JC | Clear/Red | | |
| Beveled Cap & Colors | | | |
| 5A | Black | 5D | Amber |
| 5B | White | 5F | Green |
| 5C | Red | | |

| Alternating Legends | | |
|---------------------|----------|-----------|
| 11 | ON (pos) | OFF (pos) |
| 12 | ON (neg) | OFF (neg) |
| 13 | START | STOP |
| 14 | OPEN | CLOSE |

See Part Numbers Table on Previous Page.

Contact factory for custom options.

Low Profile Pushbuttons

Series UB2

BRIGHT LED & CAPS

The electrical specifications shown are determined at a basic temperature of 25°C.
 LED circuit is isolated and requires an external power source. Polarity marks are on the bottom of the switch.
 If the source voltage exceeds the rated voltage, a ballast resistor is required.
 The resistor value can be calculated by using the formula in the Supplement section.

The LED is an integral part of the switch and not available separately.

Electrical Specifications for Bright LED

| | | 5C | 5D | 5F | |
|-----------------------------------|--------------|-------------|-----------|-----------|-------|
| | Color | Red | Amber | Green | Unit |
| Maximum Forward Current | I_{FM} | 30 | 30 | 25 | mA |
| Typical Forward Current | I_F | 20 | 20 | 20 | mA |
| Forward Voltage | V_F | 1.95 | 2.0 | 2.1 | V |
| Maximum Reverse Voltage | V_{RM} | 5 | 5 | 5 | V |
| Current Reduction Rate Above 25°C | ΔI_F | 0.40 | 0.42 | 0.46 | mA/°C |
| Ambient Temperature Range | | -25° ~ +50° | | | °C |

Bright Single Color LED with 1 element

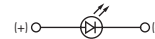

Caps for Bright LED

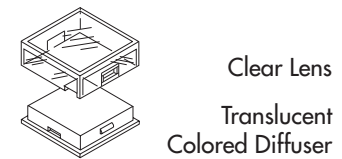
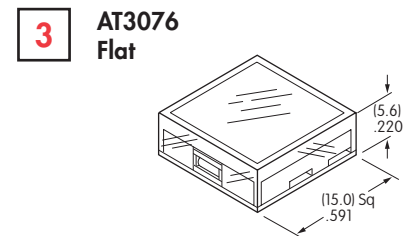
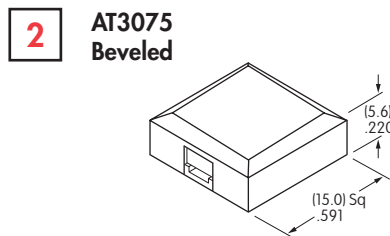
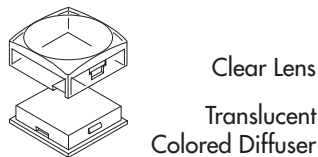
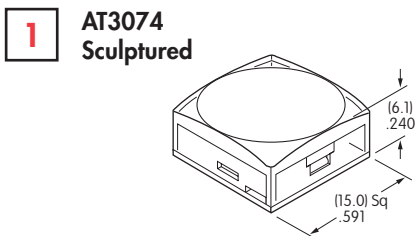

Lens/Diffuser Colors Available:

- JB** Clear/White
- JC** Clear/Red
- JD** Clear/Amber
- JF** Clear/Green

Cap Colors Available:

- B** White
- C** Red
- D** Amber
- F** Green

Lens/Diffuser Colors Available:

- JB** Clear/White
- JC** Clear/Red
- JD** Clear/Amber
- JF** Clear/Green

Material: Polycarbonate

Finish: Glossy

Series UB2

Low Profile Pushbuttons

SUPER BRIGHT LEDS & CAPS

The electrical specifications shown are determined at a basic temperature of 25°C. LED circuit is isolated and requires an external power source. Polarity marks are on the bottom of the switch. If the source voltage exceeds the rated voltage, a ballast resistor is required. The resistor value can be calculated by using the formula in the Supplement section. The LED is an integral part of the switch and not available separately.

Electrical Specifications for Super Bright LEDs

| Super Bright LEDs are Electrostatic Sensitive |  | Color | 6B White | 6F Green | 6G Blue | Unit |
|---|---|--------------|--------------------|--------------------|-------------------|-------|
| Maximum Forward Current | | I_{FM} | 20 | 30 | 30 | mA |
| Typical Forward Current | | I_F | 15 | 10 | 20 | mA |
| Forward Voltage | | V_F | 3.3 | 2.9 | 2.9 | V |
| Maximum Reverse Voltage | | V_{RM} | 5 | 5 | 5 | V |
| Current Reduction Rate Above 25°C | | ΔI_F | 0.25 | 0.33 | 0.33 | mA/°C |
| Ambient Temperature Range | | | -25° ~ +50° | | | °C |

Super Bright Single Color LED with 1 element



Caps for Super Bright LED

1JB

AT3074JB
Sculptured
Clear Lens/
White Diffuser

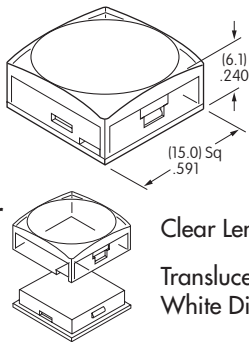

Clear Lens
Translucent
White Diffuser

2B

AT3075B
Beveled
White Cap

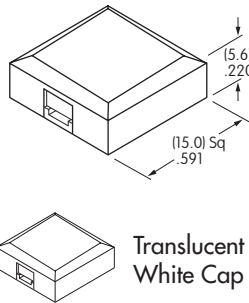

Translucent
White Cap

3JB

AT3076JB
Flat
Clear Lens/
White Diffuser

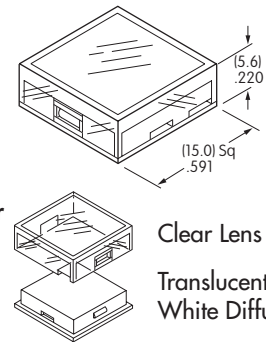

Clear Lens
Translucent
White Diffuser

Material: Polycarbonate Finish: Glossy

SUPER BRIGHT BICOLOR LEDS & CAPS

The electrical specifications shown are determined at a basic temperature of 25°C. LED circuit is isolated and requires an external power source. Polarity marks are on the bottom of the switch. If the source voltage exceeds the rated voltage, a ballast resistor is required. The resistor value can be calculated by using the formula in the Supplement section. The LED is an integral part of the switch and not available separately.

Electrical Specifications for Super Bright Bicolor LEDs

| Super Bright LEDs are Electrostatic Sensitive |  | Color | 6CF Red Green | | 6DG Amber Blue | | Unit |
|---|---|--------------|------------------------------|----------------------|-------------------------------|------|-------|
| Maximum Forward Current | | I_{FM} | 30 * 25 for Amber | 25 * 22 for Amber | 30 | 30 | mA |
| Typical Forward Current | | I_F | 20 | 20 | 15 | 15 | mA |
| Forward Voltage | | V_F | 2.1 | 3.5 | 2.0 | 2.8 | V |
| Maximum Reverse Voltage | | V_{RM} | 4 | 4 | 4 | 4 | V |
| Current Reduction Rate Above 25°C | | ΔI_F | 0.40 | 0.33 | 0.33 | 0.33 | mA/°C |
| Ambient Temperature Range | | | -20° ~ +50° | | -20° ~ +50° | | °C |

Super Bright Bicolor LED with 2 elements

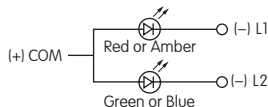

* Amber color is achieved by lighting red and green simultaneously, but is not suitable for Alternating Legends.

Toggles

Rockers

Pushbuttons

Illuminated PB

Programmable

Keylocks

Rotaries

Slides

Tactiles

Tilt

Touch

Indicators

Accessories

Supplement

Low Profile Pushbuttons

Series UB2

Caps for Super Bright Bicolor LED

1JB AT3074JB Sculptured Clear Lens/White Diffuser

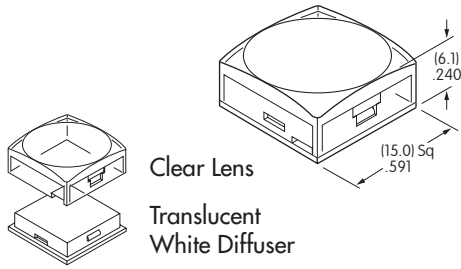

2B AT3075B Beveled White Cap

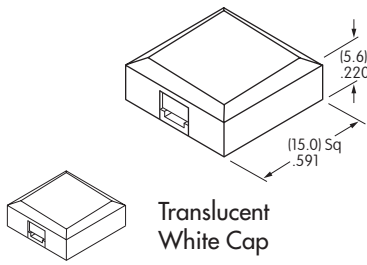

3JB AT3076JB Flat Clear Lens/White Diffuser

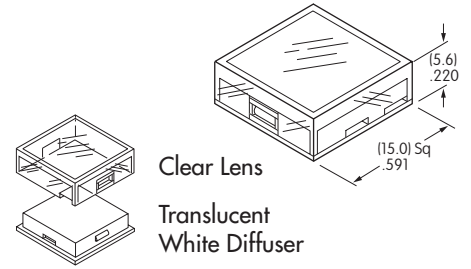

Material: Polycarbonate Finish: Glossy

Alternating Legend Caps for Super Bright Bicolor LED

AT3069J Sculptured Cap with Alternating Legend

4JCF Red/Green
4JDG Amber/Blue

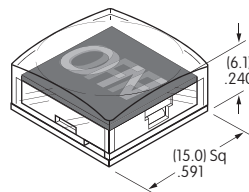

Clear Lens
Alternating Legend Filter

AT3070J Flat Cap with Alternating Legend

5JCF Red/Green
5JDG Amber/Blue

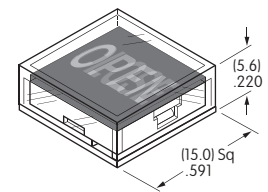

Clear Lens
Alternating Legend Filter

Material: Polycarbonate Finish: Glossy

Standard Alternating Legend Pairs



Green/Red or Blue/Amber



Green/Red or Blue/Amber



Green/Red or Blue/Amber



Green/Red or Blue/Amber

Cap illumination is alternating Green/Red or Blue/Amber; legend text is black.
Contact factory for other Alternating Legends.
Legend illustrations are approximate representations of the actual characters on the filters.

No Code No Lamp

CAP TYPES & COLOR COMBINATIONS FOR NONILLUMINATED

4 AT3073 Sculptured

Lens/Insert
Colors Available:

JA Clear/Black
JB Clear/White
JC Clear/Red
JD Clear/Amber
JF Clear/Green

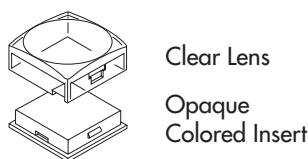
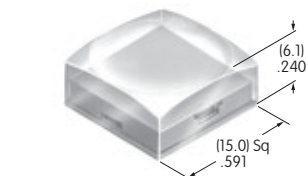

Material: Polycarbonate
Finish: Glossy

5 AT3077 Beveled

Cap
Colors Available:

A Black
B White
C Red
D Amber
F Green

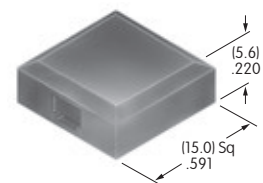

Material: Polycarbonate
Finish: Glossy

Toggles
Rockers
Pushbuttons
Illuminated PB
Programmable
Keylocks
Rotaries
Slides
Tactiles
Tilt
Touch
Indicators
Accessories
Supplement

Series UB2

Low Profile Pushbuttons

TYPICAL SWITCH DIMENSIONS

Bright & Super Bright LED Straight PC

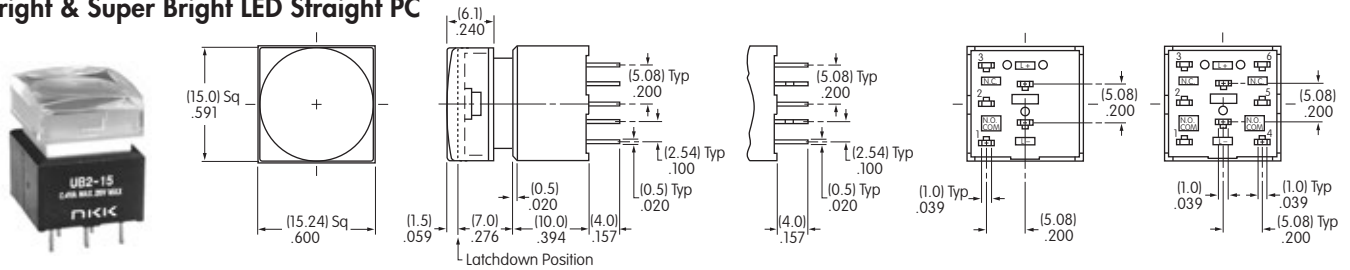

UB215SKG035C-1JC

Bright Single Color LED Super Bright Single Color LED Single Pole Double Pole

Bicolor LED Straight PC

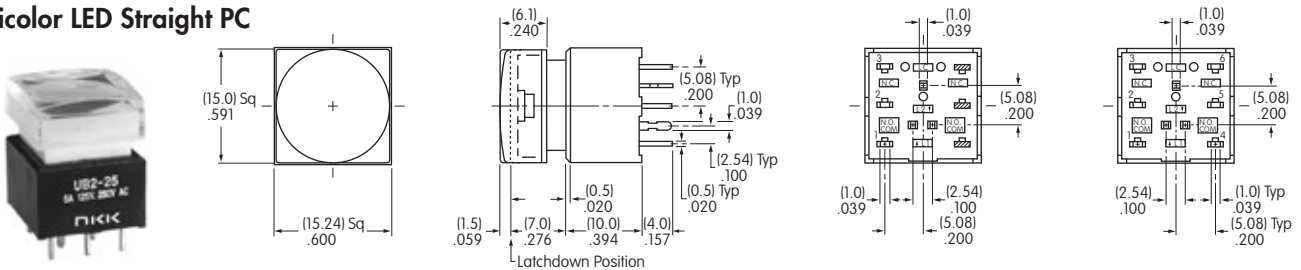

UB225SKG03CF-1JB

Bicolor LED Side View Single Pole Double Pole

Bright LED Solder Lug

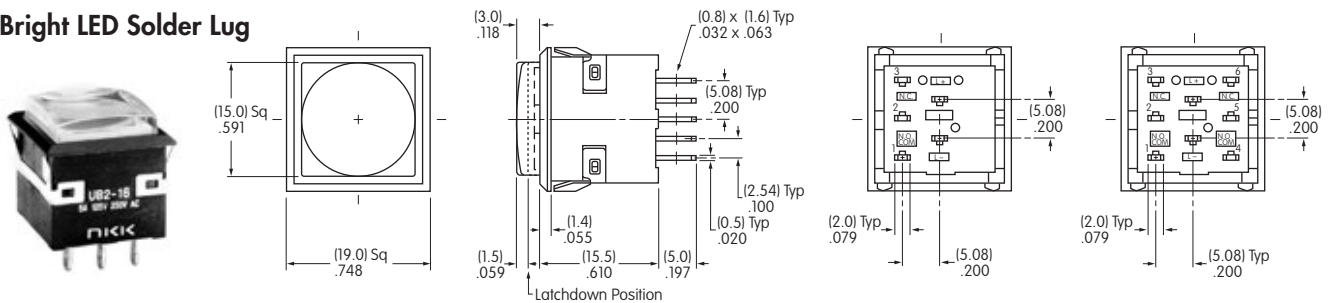

UB216KKW015F-1JF

Single Color LED Side View Single Pole Double Pole

Super Bright LED Solder Lug

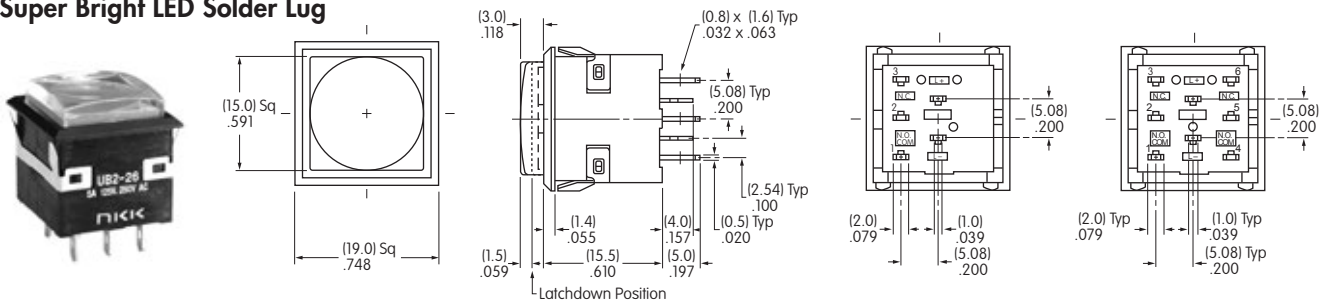

UB226KKW016F-1JF

Single Color LED Side View Single Pole Double Pole

Bicolor LED Solder Lug

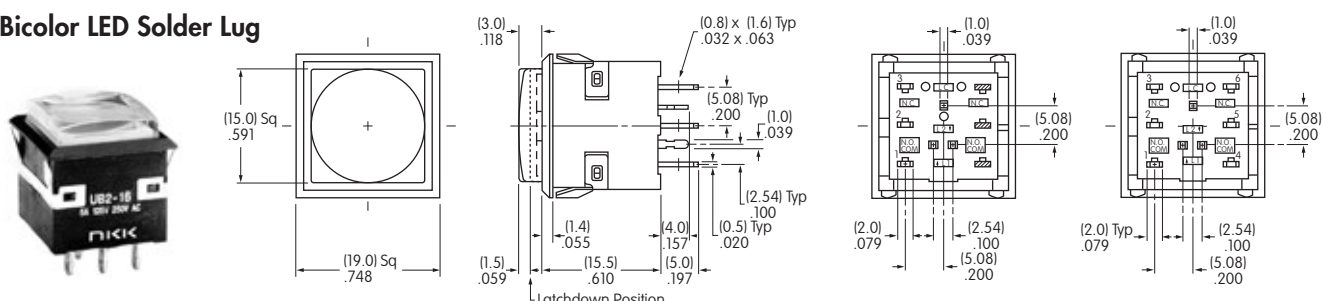

UB216KKW01CF-1JB

Bicolor LED Side View Single Pole Double Pole

Toggles

Rockers

Pushbuttons

Illuminated PB

Programmable

Keylocks

Rotaries

Slides

Tactiles

Tilt

Touch

Indicators

Accessories

Supplement

Low Profile Pushbuttons

Series UB2

OPTIONAL ACCESSORIES

Protective Guard for Snap-in Model

AT4141

Opens 90°
Closes manually



Materials:

Cover: Clear Polycarbonate
Base: Black GFR Polyamide

Recommended Panel Thickness:
.039" ~ .106" (1.0mm ~ 2.7mm)

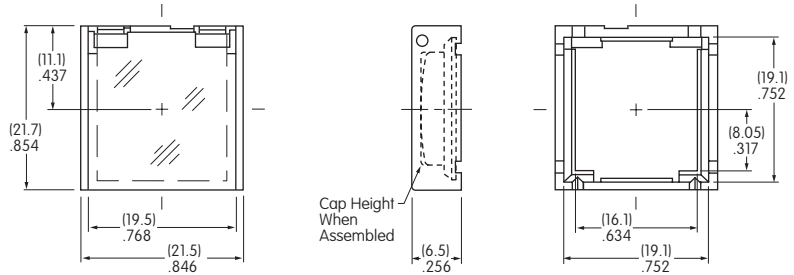

Spring Loaded Protective Guard for Snap-in Mounting of PCB Model

AT4170

Opens 180°
Closes automatically



Materials:

Cover: Clear Polycarbonate
Base: Black Polyamide
Coil Spring: Stainless Steel

Recommended Panel Thickness:
.039" ~ .126"
(1.0mm ~ 3.2mm)

Recommended Panel-to-PCB Range:
.531" (13.5mm)

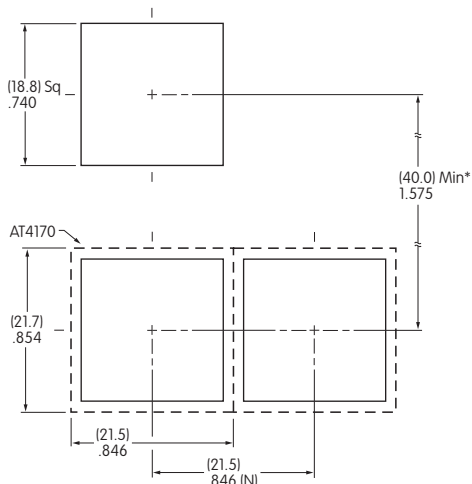
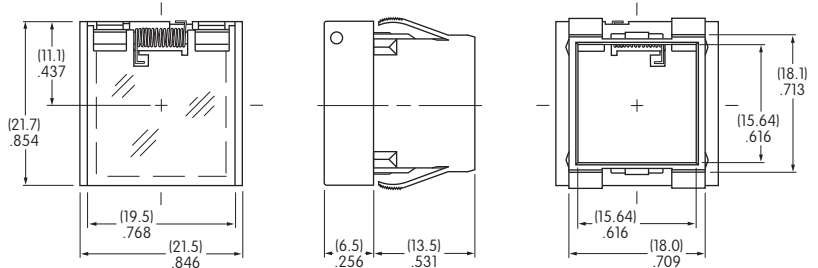

(N) = Number of switches

* Minimum dimension allows opening of cover to 180°

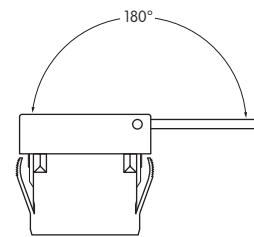
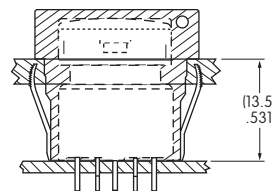

Installation

- 1 Install switch onto PC board.
- 2 Snap protective guard into panel.
- 3 Join the two assemblies.

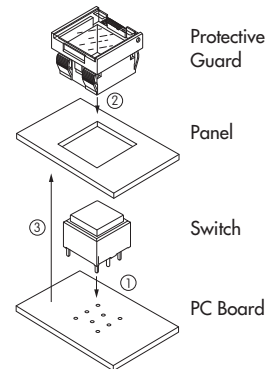

Series UB2

Low Profile Pushbuttons

OPTIONAL ACCESSORIES

Spring Loaded Protective Guard for Snap-in Model

AT4142

Opens 180°
Closes automatically



Materials:

Cover: Clear Polycarbonate
Base: Black GFR Polyamide
Coil Spring: Stainless Steel

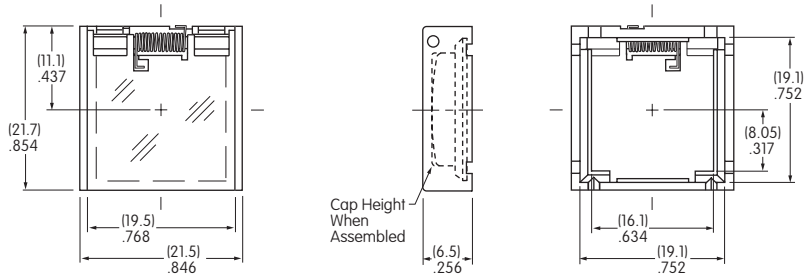

Recommended Panel Thickness:

.039" ~ .106" (1.0mm ~ 2.7mm)

Dust Cover

AT4145 Not for use with barriers.

Materials:

Lid: Clear PVC
Operating temperature range:
0°C ~ +70°C (32°F ~ 158°F).
Gasket: Polyethylene

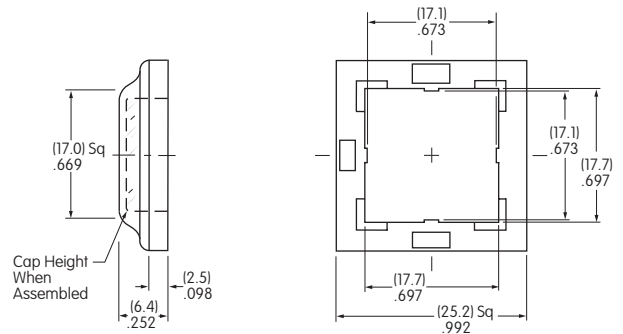
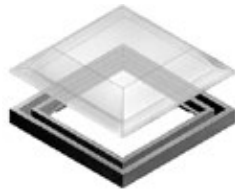

Recommended Panel Thickness

.039" ~ .098" (1.0mm ~ 2.5mm)

Barriers for Snap-in Mount

AT4143 End
AT4144 Center

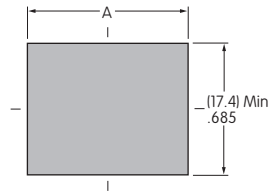
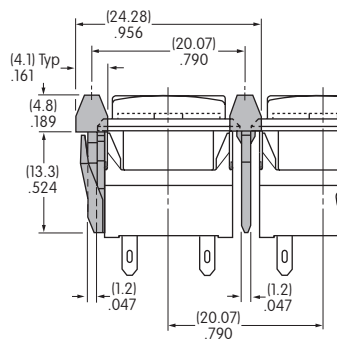
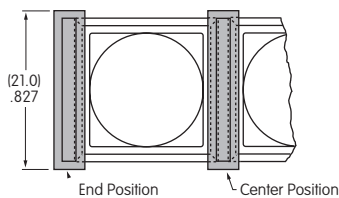

Cutouts for more than 1 Switch:

$$A = .799" (20.3\text{mm}) \times \text{Number of Switches} + .063" (1.6\text{mm})$$

Material: Polyamide

Toggles

Rockers

Pushbuttons

Programmable Illuminated PB

Keylocks

Rotaries

Slides

Tactiles

Tilt

Touch

Indicators

Accessories

Supplement

LEGENDS

NKK Switches can provide custom legends for caps. Contact factory for more information.

Suggested Printable Area for UB2 Lens, Film Insert or Diffuser

Recommended Methods: Laser Etch on clear lens, Screen Print or Pad Print on lens;
Laser Print on film insert.

Shaded areas are printable areas.

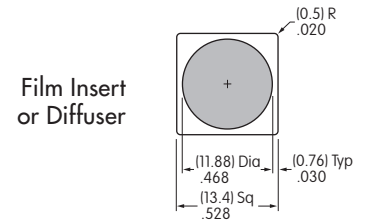
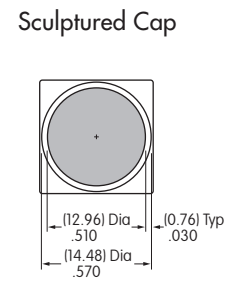
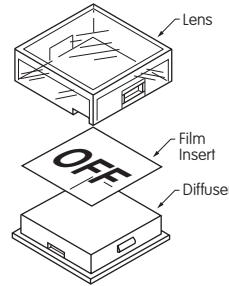
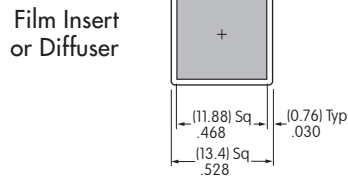
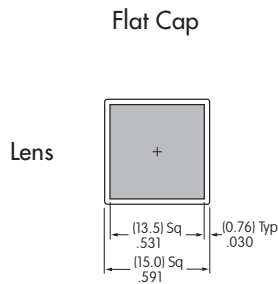
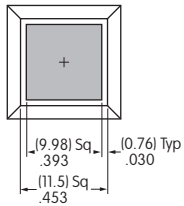
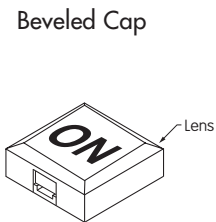

Film Insert: Clear Polyester 4 mil maximum thickness

- Toggles
- Rockers
- Pushbuttons
- Illuminated PB**
- Programmable
- Keylocks
- Rotaries
- Slides
- Tactiles
- Tilt
- Touch
- Indicators
- Accessories
- Supplement

OUR CERTIFICATE

DiGi provide top-quality products and perfect service for customer worldwide through standardization, technological innovation and continuous improvement. DiGi through third-party certification, we strictly control the quality of products and services. Welcome your RFQ to

Email: Info@DiGi-Electronics.com



Tel: +00 852-30501935

RFQ Email: Info@DiGi-Electronics.com

DiGi is a global authorized distributor of electronic components.