

YB216CWCKW01-5F24-JB Datasheet



DiGi Electronics Part Number	YB216CWCKW01-5F24-JB-DG
Manufacturer	NKK Switches
Manufacturer Product Number	YB216CWCKW01-5F24-JB
Description	STD SIZE PUSHBUTTON/ILLUMINATED/
Detailed Description	Pushbutton Switch SPDT Standard, Illuminated Panel Mount, Front

<https://www.DiGi-Electronics.com>

This model YB216CWCKW01-5F24-JB is available at DiGi Electronics.

DiGi Electronics offers a global database of semiconductor and electronic component datasheets.

We welcome your inquiries regarding pricing, lead time, or other product-related questions.

 [Request a Quote](#)

 [Datasheet Search](#)



Tel: +00 852-30501935

RFQ Email: Info@DiGi-Electronics.com

DiGi is a global authorized distributor of electronic components.

Purchase and inquiry

Manufacturer Product Number:

YB216CWCKW01-5F24-JB

Series:

YB2

Mounting Type:

Panel Mount, Front

Circuit:

SPDT

Current Rating (Amps):

3A (AC/DC)

Voltage Rating - DC:

30 V

Actuator Marking:

No Marking

Illumination Type, Color:

LED, Green

Termination Style:

Solder, Quick Connect - 0.110" (2.8mm)

Features:

Tactile Feedback

Operating Temperature:

-25°C ~ 50°C

Electrical Life:

100,000 Cycles

Manufacturer:

NKK Switches

Product Status:

Active

Type:

Standard, Illuminated

Switch Function:

On-On

Voltage Rating - AC:

125 V

Actuator Type:

Round, Button, Flush

Color - Actuator/Cap:

Clear (White Filter/Diffuser)

Illumination Voltage (Nominal):

24 VDC

Ingress Protection:

IP65 - Dust Tight, Water Resistant

Panel Cutout Dimensions:

Circular - 22.00mm Dia

Mechanical Life:

200,000 Cycles

Base Product Number:

YB216C

Environmental & Export classification

RoHS Status:

ROHS3 Compliant

ECCN:

EAR99

Moisture Sensitivity Level (MSL):

1 (Unlimited)

HTSUS:

8536.50.9033

General Specifications

Electrical Capacity (Resistive Load)

Power Level (silver):	3A @ 125V AC or 3A @ 250V AC or 3A @ 30V DC
Logic Level (gold):	0.4VA maximum @ 28V AC/DC maximum (Applicable Range 0.1mA ~ 0.1A @ 20mV ~ 28V)

Other Ratings

Contact Resistance:	50 milliohms maximum for silver; 100 milliohms maximum for gold
Insulation Resistance:	200 megohms minimum @ 500V DC
Dielectric Strength:	1,000V AC minimum between contacts for 1 minute minimum; 1,500V AC minimum between contacts & case for 1 minute minimum
Mechanical Life:	1,000,000 operations minimum for momentary circuit 200,000 operations minimum for maintained circuit
Electrical Life:	100,000 operations minimum
Nominal Operating Force:	Single pole: 1.5N Double pole: 3.0N
Contact Timing:	Nonshorting (break-before-make)
Travel:	Pretravel .059" (1.5mm); Overtravel .059" (1.5mm); Total Travel .118" (3.0mm)

Materials & Finishes

Bezel:	Black: Glass fiber reinforced polyamide (UL94V-0); Chrome plated: Chrome plating over ABS resin (UL94V-2)
Housing:	Glass fiber reinforced polyamide (UL94V-0)
Base:	Glass fiber reinforced polyamide (UL94V-0)
Movable Contactor:	Phosphor bronze with silver or gold plating
Movable Contacts:	Silver alloy or copper with gold plating
Stationary Contacts:	Silver alloy or copper with gold plating
Switch Terminals:	Phosphor bronze with tin plating
Lamp Terminals:	Phosphor bronze with tin plating

Environmental Data

Operating Temperature Range:	-25°C through +50°C (-13°F through +122°F) for Illuminated -25°C through +70°C (-13°F through +158°F) for Nonilluminated
Humidity:	90 ~ 95% humidity for 240 hours @ 40°C (104°F)
Vibration:	10 ~ 55Hz with peak-to-peak amplitude of 1.5mm traversing the frequency range & returning in 1 minute; 3 right angled directions for 2 hours
Shock:	50G (490m/s ²) acceleration (tested in 6 right angled directions, with 5 shocks in each direction)
Sealing:	IP65 of IEC60529 standard

Installation

Mounting Torque:	0.785Nm (6.95 lb•in) maximum
Soldering Time & Temperature:	Manual Soldering: See Profile A in Supplement section.

Standards & Certifications

Flammability Standards:	UL94V-0 housing, base & black bezel
UL:	File No. E44145 - Recognized only when ordered with marking on switch. Add "/CUL" before first dash in part number to order cULus marking on switch. All solder lug models recognized at 3A @ 125/250V AC or 0.4VA @ 28V AC/DC maximum.

Panel Seal Pushbuttons

Distinctive Characteristics

24mm square and 25mm diameter pushbuttons with the shortest above-panel dimension (1.8mm) in the industry for splashproof design.

Meets IP65 of IEC60529 standards (similar to NEMA 4 and 13), providing dust tight and splashproof panel seal protection.

Tamper resistant 18mm square and 19mm diameter actuators.

Short body of .965" (24.5mm) conserves behind-panel space.

Distinctive long stroke and light touch actuation for clear indication of circuit status.

Choice of cap colors includes clear, brushed chrome, red, green, or yellow, for enhanced panel appearance. Metallic silver cap option has bright ring illumination (round only). Unbrushed chrome has the look of stainless steel when non-illuminated, and LED color or legends when illuminated.

Brilliant illumination with multiple LED colors.

Bezel color options in black or brushed chrome.

Brushed chrome option is lighter weight than actual metal switches due to metal plating on resin.

Available in momentary and alternate action with latchdown.

Crisp actuation and clear circuit status provided by snap-action contact mechanism. Arc barrier protects against crossover.

Combination solder lug and .110" quick connect terminals. Terminals are epoxy sealed to lock out flux, dust, solvents, and other contaminants, as well as to secure terminals and improve contact stability.

Custom legends on actuator or inserts.



Actual Size (Round)



Toggles

Rockers

Pushbuttons

D
Illuminated PB

Programmable

Keylocks

Rotaries

Slides

Tactiles

Tilt

Touch

Indicators

Accessories

Supplement

Series YB2

Panel Seal Pushbuttons

TYPICAL SWITCH

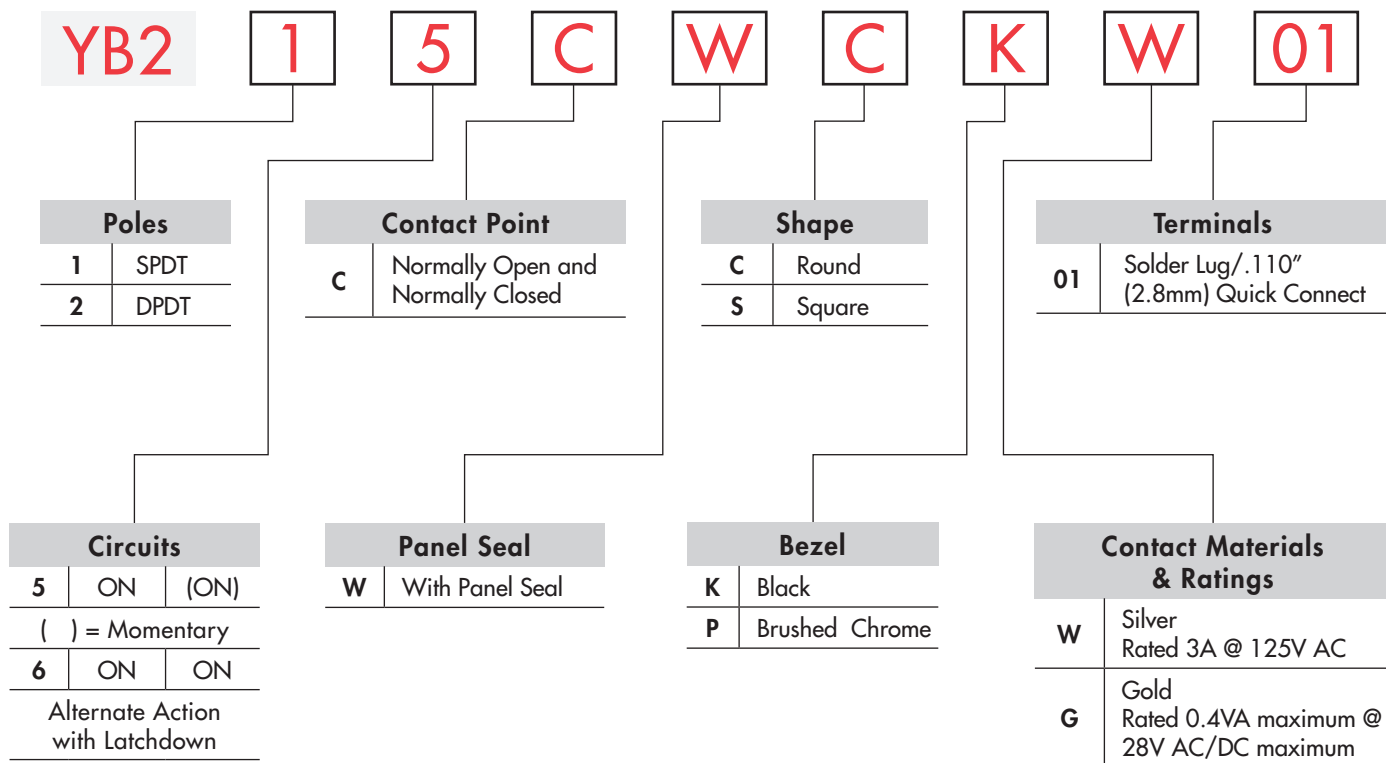

IMPORTANT:



Switches are supplied without cULus marking unless specified.
cULus recognized only when ordered with marking on the switch.
 Specific models, ratings, and ordering instructions are noted on General Specifications page.

DESCRIPTION FOR TYPICAL ORDERING EXAMPLE

YB215CWCKW01-6B-JB







Panel Seal Pushbuttons

Series YB2

ORDERING EXAMPLE

LEDS				Cap Types & Colors	
Bright LED				Lens/Diffuser Colors	
LED Colors		Resistor		JB	Clear/White
5C	Red	No Code	No Resistor (not for Green)	JS	Metallic Silver Cap/Clear Ring (Round only)
5D	Amber		05	5-volt	CB
5F	Green	12	12-volt	EB	Yellow/White
		24	24-volt	FB	Green/White
				HB	Unbrushed Chrome/White
LED and cap need to be the same color. Yellow cap pairs with amber LED to achieve amber illumination. Codes JB and JS (Round only) may be combined with all LED colors.					
Super Bright LED				Lens/Diffuser Cap Colors	
6B	White			JB	Clear/White
6F	Green			JS	Metallic Silver Cap/Clear Ring (Round only)
6G	Blue			HB	Unbrushed Chrome/White
Nonilluminated				Cap Color	
N	No Lamp			JB	Clear/White
				CB	Red/White
				EB	Yellow/White
				FB	Green/White
				HB	Unbrushed Chrome/White
				P	Brushed Chrome

Round or Square Cap with Legend	
001	
002	START
003	STANDBY
004	STOP
005	
Contact factory for custom options.	

Round or Square Cap with Legend	
001	
002	START
003	STANDBY
004	STOP
005	
Contact factory for custom options.	

Part Numbers for Unbrushed Chrome Caps with Legends

Round Cap for Bright LED	Round Cap for Super Bright LED	Square Cap for Bright or Super Bright LED
AT3017HB-001	AT3018HB-001	AT3025HB-001
AT3017HB-002	AT3018HB-002	AT3025HB-002
AT3017HB-003	AT3018HB-003	AT3025HB-003
AT3017HB-004	AT3018HB-004	AT3025HB-004
AT3017HB-005	AT3018HB-005	AT3025HB-005

Refer to Ordering Table for legend that corresponds with last 3 digits of part number.

Series YB2

Panel Seal Pushbuttons

Toggles

Rockers

Pushbuttons

illuminated PB

Programmable

Keylocks

Rotaries

Slides

Tactiles

Tilt

Touch

Indicators

Accessories

Supplement

POLES & CIRCUITS

		Plunger Position () = Momentary		Connected Terminals		Throw & Switch/Lamp Schematics
Pole	Model	Normal	Down	Normal	Down	Notes: Switch is marked with NC, NO, COM, L+, L-. Lamp circuit is isolated and requires an external power source.
SP	YB215 YB216	ON ON	(ON) ON	1-3	1-2	SPDT
DP	YB225 YB226	ON ON	(ON) ON	1-3 4-6	1-2 4-5	DPDT

CONTACT POINT

C Normally Open and Normally Closed

Contact points are both Normally Open and Normally Closed.

PANEL SEAL

W Panel Seal (Round and Square)

Two o-rings provide panel seal protection meeting IP65 of IEC60529 standards.

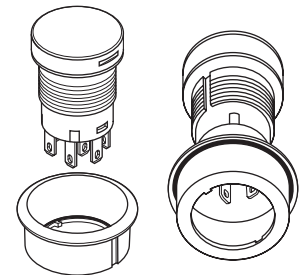

SHAPE

C Round

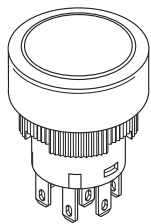

S Square

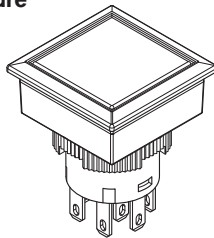

BEZEL

K Black

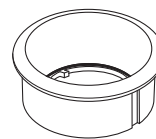

P Brushed Chrome

For Round or Square

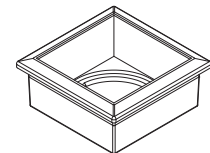

CONTACT MATERIALS & RATINGS

W Silver Contacts

Power Level: 3A @ 125/250V AC
Switch base is black

G Gold Contacts

Logic Level: 0.4VA max. @ 28V AC/DC max.
Switch base is ivory

TERMINALS

01 Solder Lug/
.110" (2.8mm) Quick Connect

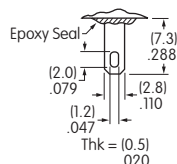

Panel Seal Pushbuttons

Series YB2

BRIGHT & SUPER BRIGHT LEDs

The electrical specifications shown are determined at a basic temperature of 25°C. LED circuit is isolated and requires an external power source. If the source voltage exceeds the rated voltage, a ballast resistor is required.
 Base of AT634 and AT636 is Black for 5V, Light Blue for 12V and Gray for 24V.

Electrical Specifications for Bright LED without Resistor

Bright AT628  T-1 Bi-pin 	Colors Available: 5C Red 5D Amber No Code No Resistor	Unit
	LED Colors	Red Amber
	Maximum Forward Current	I_{FM} 40 40 mA
	Typical Forward Current	I_F 26 26 mA
	Forward Voltage	V_F 1.9 2.0 V
	Maximum Reverse Voltage	V_{RM} 4 4 V
	Current Reduction Rate Above 25°C	ΔI_F 0.50 mA/°C
Ambient Temperature Range	-25 ~ +50 °C	

Electrical Specifications for Bright Red & Amber LED with Resistor

Bright AT634  T-1 1/4 Bi-pin	Colors Available: 5C Red 5D Amber 05 12 24	Unit
	Maximum Forward Current	I_{FM} — — — mA
	Typical Forward Current	I_F 25 20 10 mA
	Forward Voltage	V_F 5 12 24 V
	Maximum Reverse Voltage	V_{RM} 4 8 16 V
	Current Reduction Rate Above 25°C	ΔI_F — — — mA/°C
	Ambient Temperature Range	-25 ~ +50 °C

AT634
5-volt,
2-element
with Resistor

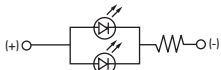

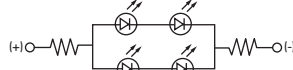

AT634
12-volt,
4-element
with Resistor





AT634
24-volt,
4-element
with Resistor

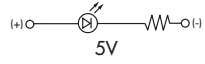
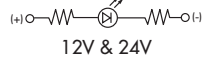

Electrical Specifications for Bright Green LED with Resistor

Bright AT636  T-1 1/4 Bi-pin  5V  12V & 24V	Colors Available:  5F Green 05 12 24	Unit
	Maximum Forward Current	I_{FM} — — — mA
	Typical Forward Current	I_F 11 9.5 8.7 mA
	Forward Voltage	V_F 5 12 24 V
	Maximum Reverse Voltage	V_{RM} 5 5 5 V
	Current Reduction Rate Above 25°C	ΔI_F — — — mA/°C
	Ambient Temperature Range	-25 ~ +50 °C

Electrical Specifications for Super Bright LED

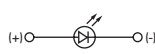
Super Bright AT625G Blue AT631B White AT632F Green  T-1 Bi-pin  	Colors: 6B White 6F Green 6G Blue	Unit
	Maximum Forward Current	I_{FM} 30 30 30 mA
	Typical Forward Current	I_F 20 20 20 mA
	Forward Voltage	V_F 3.3 3.3 3.3 V
	Maximum Reverse Voltage	V_{RM} 7 7 7 V
	Current Reduction Rate Above 25°C	ΔI_F 0.40 0.40 0.40 mA/°C
	Ambient Temperature Range	-25 ~ +50 °C

Toggles
 Rockers
 Pushbuttons
D Illuminated PB
 Programmable
 Keylocks
 Rotaries
 Slides
 Tactiles
 Tilt
 Touch
 Indicators
 Accessories
 Supplement

Series YB2

Panel Seal Pushbuttons

BALLAST RESISTOR CALCULATION FOR LEDs

If the source voltage is greater than the rated voltage of a lamp or LED, a ballast resistor must be connected in series with the lamp. This circuit diagram and formula will assist in calculating the value of the required ballast resistor.

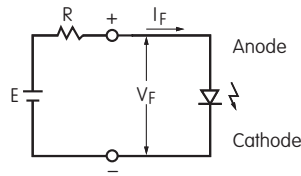

$$R = \frac{E - V_F}{I_F}$$

Where: R = Resistor Value (Ohms)
 E = Source Voltage (V)
 V_F = Forward Voltage (V)
 I_F = Forward Current (A)

CAPS & CAP COLORS

AT3017 Cap for Bright LED or Nonilluminated

Lens/Diffuser Colors Available:

- JB** Clear/White
- CB** Red/White
- EB** *Yellow/White
- FB** Green/White
- HB** Unbrushed Chrome/White

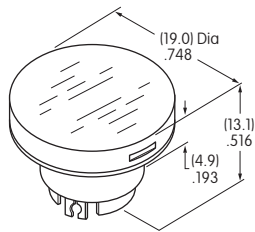

AT3018 Cap for Super Bright LED

Lens/Diffuser Colors Available:

- JB** Clear/White
- HB** Unbrushed Chrome/White

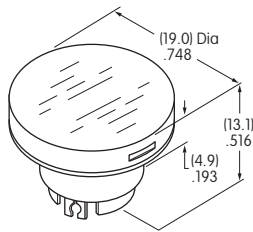

Material for Lens & Diffuser: Polycarbonate
 HB Lens: ABS Resin & Unbrushed Chrome Plating

AT3019 Cap for Nonilluminated

Cap Color Available:

- P** Brushed Chrome

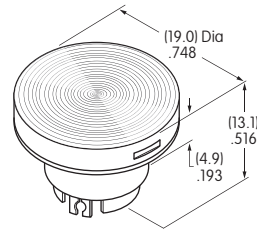

Material for Lens: ABS Resin & Brushed Chrome Plating

AT3020 Cap with Illumination Ring for Bright or Super Bright LED

Cap Color Available:

- JS** Metallic Silver with Clear Ring

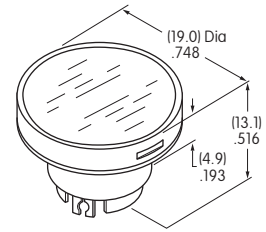

Materials
 Lens: Polycarbonate
 Insert: Polyester

*Yellow cap pairs with amber LED to achieve amber illumination.

AT3025 Cap for Illuminated or Nonilluminated

Lens/Diffuser Colors Available:

- JB** Clear/White For Bright & Super Bright LEDs
- CB** Red/White For Bright LED only
- EB** *Yellow/White For Bright LED only
- FB** Green/White For Bright LED only
- HB** Unbrushed Chrome/White For Bright & Super Bright LEDs

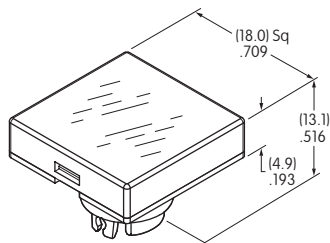

Material for Lens & Diffuser: Polycarbonate

AT3027 Cap for Nonilluminated

Cap Color Available:

- P** Brushed Chrome

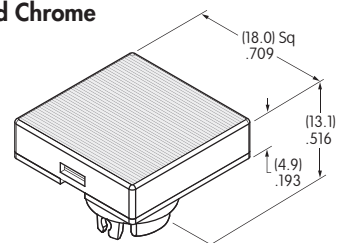

Material for Lens: ABS Resin & Brushed Chrome Plating

*Yellow cap pairs with amber LED to achieve amber illumination.

Toggles
Rockers
Pushbuttons
Illuminated PB
Programmable
Keylocks
Rotaries
Slides
Tactiles
Tilt
Touch
Indicators
Accessories
Supplement

Standard Legends for Unbrushed Chrome Caps

001



Round or Square Cap
Bright or Super Bright LED

002



Round or Square Cap
Bright or Super Bright LED

003



Round or Square Cap
Bright or Super Bright LED

004



Round or Square Cap
Bright or Super Bright LED

005



Round or Square Cap
Bright or Super Bright LED

Images appear the color of the LED when lit.
Contact factory for other legends options.

Legend illustrations are approximate representations of the actual images on the caps.

Unbrushed Chrome/White Cap with Lens/Diffuser



Without Illumination



With Illumination

Depending on the design and the color of ink used, the legend may be visible when it is not illuminated.
It is recommended that the legend be clear and without ink in order to achieve the maximum visibility when the cap is illuminated.

Toggles

Rockers

Pushbuttons

D Illuminated PB

Programmable

Keylocks

Rotaries

Slides

Tactiles

Tilt

Touch

Indicators

Accessories

Supplement

Series YB2

Panel Seal Pushbuttons

TYPICAL SWITCH DIMENSIONS

Toggles

Rockers

Pushbuttons

illuminated PB

Programmable

Keylocks

Rotaries

Slides

Tactiles

Tilt

Touch

Indicators

Accessories

Supplement

Single Pole

Double Pole

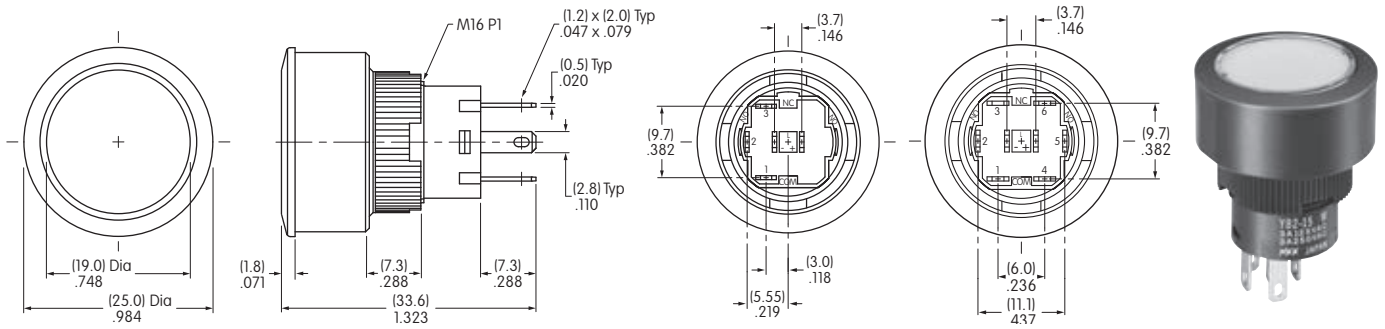

YB215CWCKW01-6B-JB

Single Pole

Double Pole

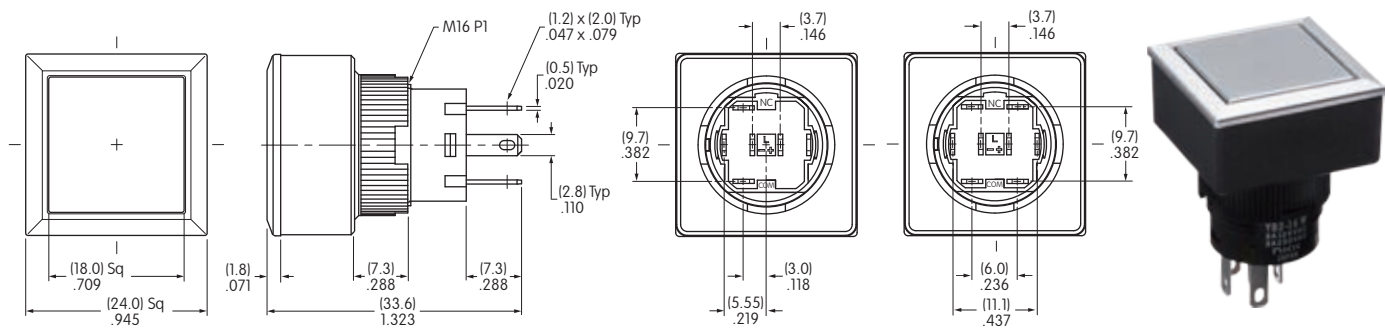

YB216CWSPW01-N-P

PANEL THICKNESS & CUTOUT

Recommended Panel Thickness
.020" ~ .197"
(0.5mm ~ 5.0mm)

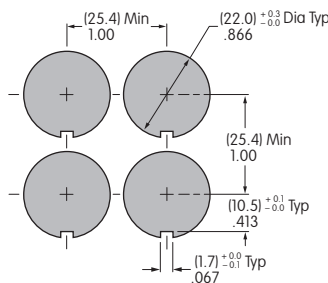

Side-by-side Mounting

Recommended Panel Thickness
.020" ~ .197"
(0.5mm ~ 5.0mm)

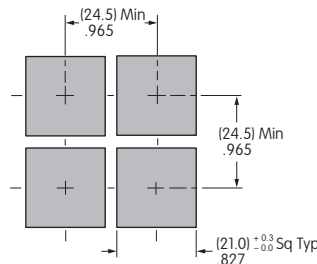

Side-by-side Mounting

OPTIONAL ACCESSORIES

Adaptors

AT716
Single Pole
Solder Lug/
Quick Connect
Terminals

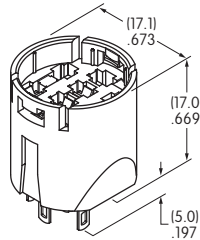
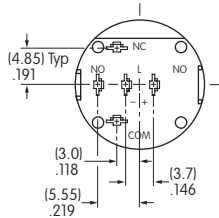

AT717
Double Pole
Solder Lug/
Quick Connect
Terminals

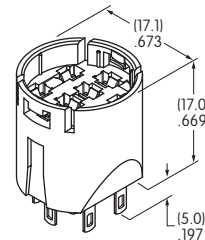
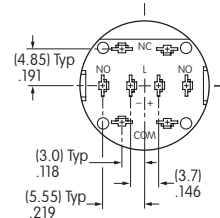

AT718
Single Pole
Straight PC
Terminals

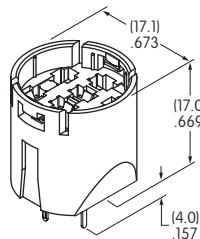
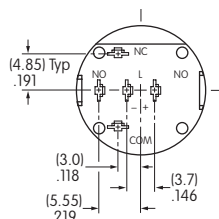

AT719
Double Pole
Straight PC
Terminals

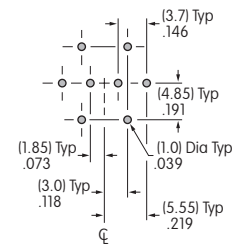
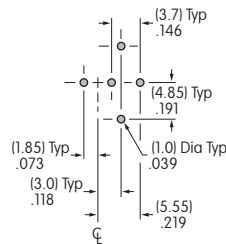
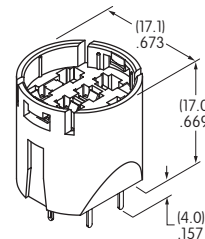
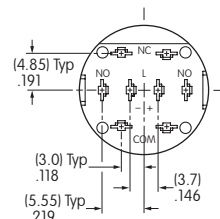

Material: Glass fiber reinforced polyamide Note: Order adaptors separately

Round & Square Switch Dimensions Shown with Adaptor AT716

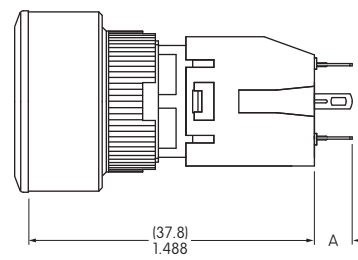
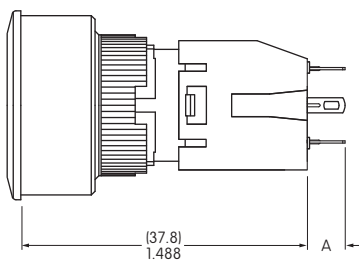

Dimension A:

Solder Lug .197" (5.0mm); Straight PC .157" (4.0mm)

Panel thickness for YB2 Round:
.020" ~ .161" (0.5mm ~ 4.1mm)

Panel thickness for YB2 Square:
.020" ~ .126" (0.5mm ~ 3.2mm)

Toggles
Rocker
Pushbuttons
Illuminated PB
Programmable
Keylocks
Rotaries
Slides
Tactiles
Tilt
Touch
Indicators
Accessories
Supplement

Series YB2

Panel Seal Pushbuttons

ASSEMBLY INSTRUCTIONS FOR ROUND

1. Remove knurled mounting nut.



5. Install the red o-ring which was removed in step 2 at the inside bottom of the bezel.



2. Remove bezel and red o-ring from housing. There are two o-rings in this assembly: one is red, one is orange.



6. Align tab inside of the bezel with keyway on housing and bring bezel back into its original position.

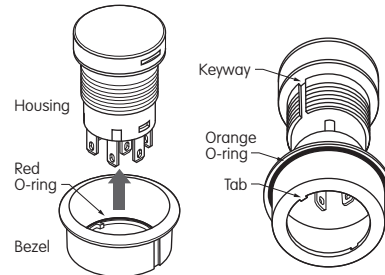

3. Install LED.



7. Before installing into panel, make sure that the orange o-ring is present at the back of the bezel. Align keyway on bezel with tab in panel and push switch all the way into the panel.

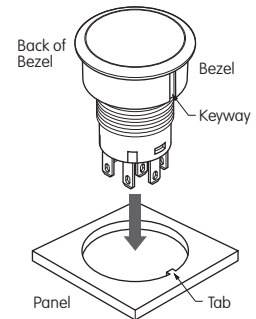

LEDs AT634 & AT636



Align D-flat on LED with Part Number on switch for appropriate polarity and insert LED into base.

LED AT628

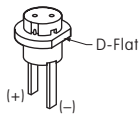

Align D-flat on LED with Part Number on switch for appropriate polarity and insert LED into base.



LEDs AT625G, AT631B, AT632F

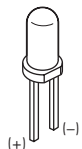

The larger metal part within the LED represents the cathode (-). Align LED for appropriate polarity and insert LED into base.

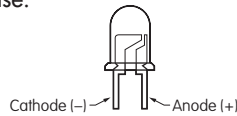

4. Align tabs (B) on both sides of actuator with the projections (A) inside of the housing and push actuator firmly down to snap in.

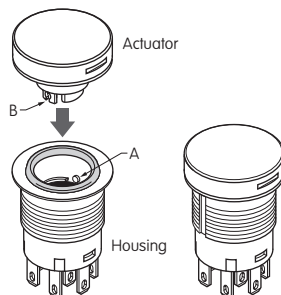

8. Attach mounting nut behind panel and tighten. Make sure that bezel and actuator fit properly and that there is no space between bezel and panel. Do not overtighten.

Mounting torque: 0.785Nm (6.95 lb•in) maximum. Optional socket wrench AT106 available.

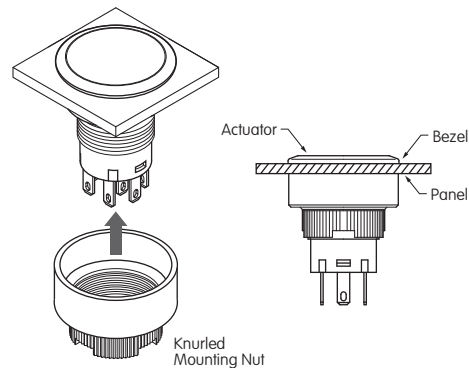

AT106 Socket Wrench



Toggles
Rockers
Pushbuttons
Illuminated PB
Programmable
Keylocks
Rotaries
Slides
Tactiles
Tilt
Touch
Indicators
Accessories
Supplement

Panel Seal Pushbuttons

Series YB2

ASSEMBLY INSTRUCTIONS FOR SQUARE

1. Remove knurled mounting nut.

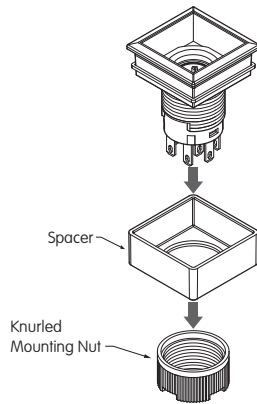

2. Remove bezel and blue o-ring from housing.

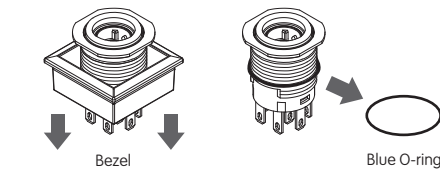

3. Install LED.



LEDs
AT634 & AT636

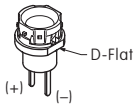

Align D-flat on LED with Part Number on switch for appropriate polarity and insert LED into base.

LED AT628

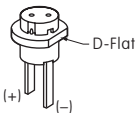

Align D-flat on LED with Part Number on switch for appropriate polarity and insert LED into base.



LEDs AT625G,
AT631B,
AT632F

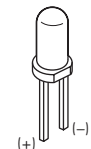

The larger metal part within the LED represents the cathode (-). Align LED for appropriate polarity and insert LED into base.

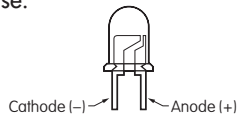

4. Align tabs (B) on both sides of actuator with the projections (A) inside of the housing and push actuator firmly down to snap in.

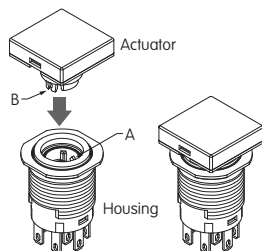

5. Install the blue o-ring which was removed in step 2 at the inside bottom of the bezel.

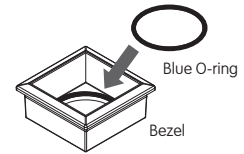

6. Align tab inside of the bezel with keyway on housing and bring bezel back into its original position.



7. Before installing into panel, make sure that the square gasket is present at the back of the bezel. Align keyway on bezel with tab in panel and push switch all the way into the panel.

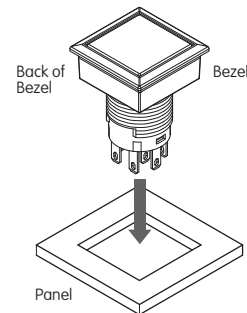

8. Attach mounting nut behind panel and tighten. Make sure that bezel and actuator fit properly and that there is no space between bezel and panel. Do not overtighten.

Mounting torque: 0.785Nm (6.95 lb•in) maximum.
Optional socket wrench AT106 available.

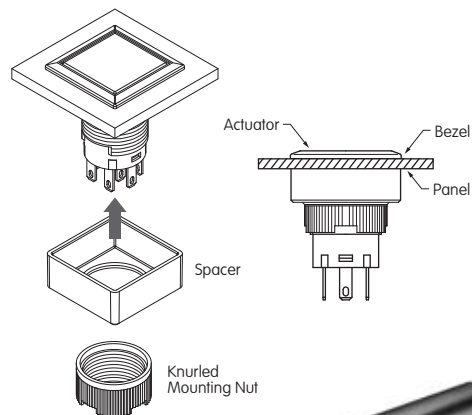

AT106 Socket Wrench



Toggles

Rockers

Pushbuttons

illuminated PB

Programmable

Keylocks

Rotaries

Slides

Tactiles

Tilt

Touch

Indicators

Accessories

Supplement

LEGENDS

NKK Switches can provide custom legends for caps. Contact factory for more information.

Suggested Printable Area for YB2 Caps

Recommended Methods: Laser Etch on clear cap, Screen Print or Pad Print on cap.
Epoxy based ink is recommended.

For Caps
AT3017, AT3018, and AT3019

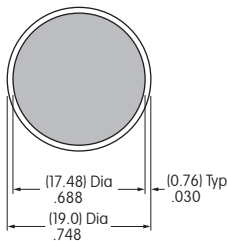

For Cap
AT3020 (with clear ring for illumination)

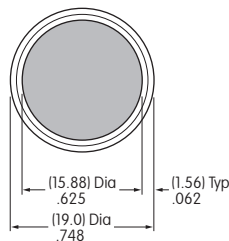

For Caps
AT3025 and AT3027

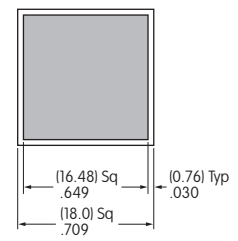

Shaded areas are printable areas.

Suggested Printable Area for Film Inserts

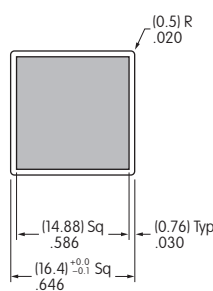

Recommended Method:

Screen Print; Epoxy based ink is recommended

Film Material and Thickness:

Clear Polyester, 4 mil max.

Shaded areas are printable areas.

HANDLING & PRECAUTIONS



LEDs are electrostatic sensitive devices. When installing and handling LEDs, use an electrostatic protected work station to prevent LED damage.

OUR CERTIFICATE

DiGi provide top-quality products and perfect service for customer worldwide through standardization, technological innovation and continuous improvement. DiGi through third-party certification, we stricly control the quality of products and services. Welcome your RFQ to

Email: Info@DiGi-Electronics.com



Tel: +00 852-30501935

RFQ Email: Info@DiGi-Electronics.com

DiGi is a global authorized distributor of electronic components.