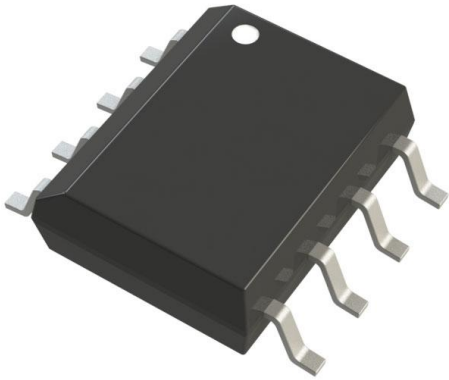


SA630D/01,112 Datasheet

www.digi-electronics.com



<https://www.DiGi-Electronics.com>

DiGi Electronics Part Number	SA630D/01,112-DG
Manufacturer	NXP USA Inc.
Manufacturer Product Number	SA630D/01,112
Description	IC RF SWITCH SPDT 1GHZ 8SO
Detailed Description	RF Switch IC General Purpose SPDT 1 GHz 50Ohm 8-SO

This model SA630D/01,112 is available at DiGi Electronics.

DiGi Electronics offers a global database of semiconductor and electronic component datasheets.

We welcome your inquiries regarding pricing, lead time, or other product-related questions.

 [Request a Quote](#)

 [Datasheet Search](#)



Tel: +00 852-30501935

RFQ Email: Info@DiGi-Electronics.com

DiGi is a global authorized distributor of electronic components.

Purchase and inquiry

Manufacturer Product Number:

SA630D/01,112

Series:

-

RF Type:

General Purpose

Circuit:

SPDT

Isolation:

30dB

Test Frequency:

900MHz

IIP3:

33dBm

Impedance:

50Ohm

Operating Temperature:

-40°C ~ 85°C

Package / Case:

8-SOIC (0.154", 3.90mm Width)

Base Product Number:

SA630

Manufacturer:

NXP USA Inc.

Product Status:

Obsolete

Topology:

Absorptive

Frequency Range:

0Hz ~ 1GHz

Insertion Loss:

2dB

P1dB:

18dBm

Features:

Single Line Control

Voltage - Supply:

3V ~ 5.5V

Mounting Type:

Surface Mount

Supplier Device Package:

8-SO

Environmental & Export classification

RoHS Status:

ROHS3 Compliant

REACH Status:

REACH Unaffected

HTSUS:

8542.39.0001

Moisture Sensitivity Level (MSL):

1 (Unlimited)

ECCN:

EAR99

SA630

Single-Pole Double-Throw (SPDT) switch

Rev. 3 — 23 July 2014

Product data sheet

1. General description

The SA630 is a wideband RF switch fabricated in BiCMOS technology and incorporating on-chip CMOS/TTL compatible drivers. Its primary function is to switch signals in the frequency range DC to 1 GHz from one 50 Ω channel to another. The switch is activated by a CMOS/TTL compatible signal applied to the enable channel 1 pin (ENCH1).

The extremely low current consumption makes the SA630 ideal for portable applications. The excellent isolation and low loss makes this device a suitable replacement for PIN diodes.

The SA630 is available in an 8-pin SO (surface-mounted miniature) package.

2. Features and benefits

- Wideband (DC to 1 GHz)
- Low through loss (1 dB typical at 200 MHz)
- Unused input is terminated internally in 50 Ω
- Excellent overload capability (1 dB gain compression point +18 dBm at 300 MHz)
- Low DC power (170 μ A from 5 V supply)
- Fast switching (20 ns typical)
- Good isolation (off channel isolation 60 dB at 100 MHz)
- Low distortion (IP3 intercept +33 dBm)
- Good 50 Ω match (return loss 18 dB at 400 MHz)
- Full ESD protection
- Bidirectional operation

3. Applications

- Digital transceiver front-end switch
- Antenna switch
- Filter selection
- Video switch
- FSK transmitter



4. Ordering information

Table 1. Ordering information

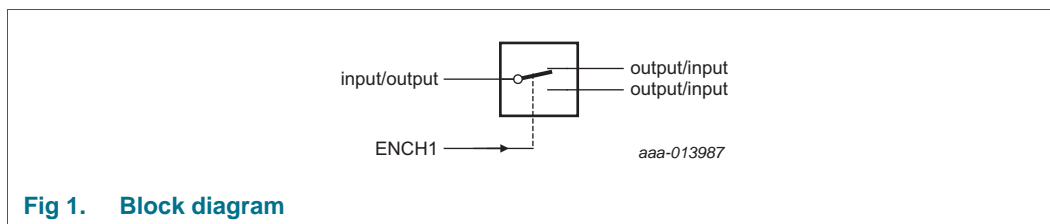
Type number	Topside marking	Package		
		Name	Description	Version
SA630D/01	SA630D	SO8	plastic small outline package; 8 leads; body width 3.9 mm	SOT96-1

4.1 Ordering options

Table 2. Ordering options

Type number	Orderable part number	Package	Packing method	Minimum order quantity	Temperature
SA630D/01	SA630D/01,112	SO8	Standard marking *IC's tube - DSC bulk pack	2000	$T_{amb} = -40\text{ }^{\circ}\text{C to }+85\text{ }^{\circ}\text{C}$
	SA630D/01,118	SO8	Reel 13" Q1/T1 *Standard mark SMD	2500	$T_{amb} = -40\text{ }^{\circ}\text{C to }+85\text{ }^{\circ}\text{C}$

5. Block diagram



8. Limiting values

Table 4. Limiting values

In accordance with the Absolute Maximum Rating System (IEC 60134).

Symbol	Parameter	Conditions	Min	Max	Unit
V_{DD}	supply voltage		-0.5	+5.5	V
P	power dissipation	$T_{amb} = 25\text{ °C}$ (still air) [1]	-	780	mW
$T_{j(max)}$	maximum junction temperature		-	150	°C
$P_{i(max)}$	maximum input power		-	+20	dBm
$P_{o(max)}$	maximum output power		-	+20	dBm
T_{stg}	storage temperature		-65	+150	°C

[1] Maximum dissipation is determined by the operating ambient temperature and the thermal resistance $R_{th(j-a)}$.

9. Recommended operating conditions

Table 5. Operating conditions

Symbol	Parameter	Conditions	Min	Max	Unit
V_{DD}	supply voltage		3.0	5.5	V
T_{amb}	ambient temperature	operating	-40	+85	°C
T_j	junction temperature	operating	-40	+105	°C

10. Thermal characteristics

Table 6. Thermal characteristics

Symbol	Parameter	Conditions	Typ	Unit
$R_{th(j-a)}$	thermal resistance from junction to ambient	SO8 package	158	°C/W

11. Static characteristics

Table 7. Static characteristics

$V_{DD} = +5\text{ V}$; $T_{amb} = 25\text{ °C}$; unless otherwise specified.

Symbol	Parameter	Conditions	Min	Typ	Max	Unit
I_{DD}	supply current		40	170	300	μA
V_{th}	threshold voltage	TTL/CMOS logic [1]	1.1	1.25	1.4	V
V_{IH}	HIGH-level input voltage	logic 1 level; enable channel 1	2.0	-	V_{DD}	V
V_{IL}	LOW-level input voltage	logic 0 level; enable channel 2	-0.3	-	+0.8	V
$I_{IL}(\text{ENCH1})$	LOW-level input current on pin ENCH1	ENCH1 = 0.4 V	-1	0	+1	μA
$I_{IH}(\text{ENCH1})$	HIGH-level input current on pin ENCH1	ENCH1 = 2.4 V	-1	0	+1	μA

[1] The ENCH1 input must be connected to a valid logic level for proper operation of the SA630.

12. Dynamic characteristics

Table 8. Dynamic characteristics

All measurements include the effects of the SA630 evaluation board ([Figure 19](#)). Measurement system impedance is $50\ \Omega$.

Symbol	Parameter	Conditions	Min	Typ	Max	Unit
S_{21}, S_{12}	insertion loss (ON channel)	DC to 100 MHz	-	1	-	dB
		500 MHz	-	1.4	-	dB
		900 MHz	-	2	2.8	dB
S_{21}, S_{12}	isolation (OFF channel) [1]	10 MHz	70	80	-	dB
		100 MHz	-	60	-	dB
		500 MHz	-	50	-	dB
		900 MHz	24	30	-	dB
S_{11}, S_{22}	return loss (ON channel)	DC to 400 MHz	-	20	-	dB
		900 MHz	-	12	-	dB
S_{11}, S_{22}	return loss (OFF channel)	DC to 400 MHz	-	17	-	dB
		900 MHz	-	13	-	dB
$t_{d(\text{off})}$	turn-off delay time	50 % TTL to (90 % to 10 %) RF	-	20	-	ns
$t_{f(\text{off})}$	turn-off fall time	90 % to 10 % RF	-	5	-	ns
$t_{r(\text{on})}$	turn-on rise time	10 % to 90 % RF	-	5	-	ns
$V_{trt(p-p)}$	peak-to-peak transient voltage	switching transients	-	165	-	mV
$P_{L(1\text{dB})}$	output power at 1 dB gain compression	DC to 1 GHz	-	+18	-	dBm
IP3	third-order intercept point	100 MHz	-	+33	-	dBm
IP2	second-order intercept point	100 MHz	-	+52	-	dBm
NF	noise figure	$Z_o = 50\ \Omega$				
		100 MHz	-	1.0	-	dB
		900 MHz	-	2.0	-	dB

[1] The placement of the AC bypass capacitor is critical to achieve these specifications. See [Section 14](#) for more details.

13. Performance curves

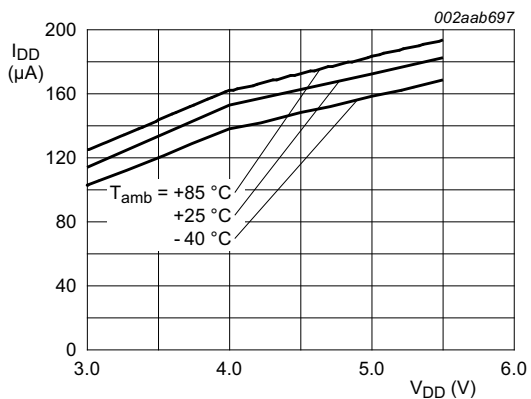
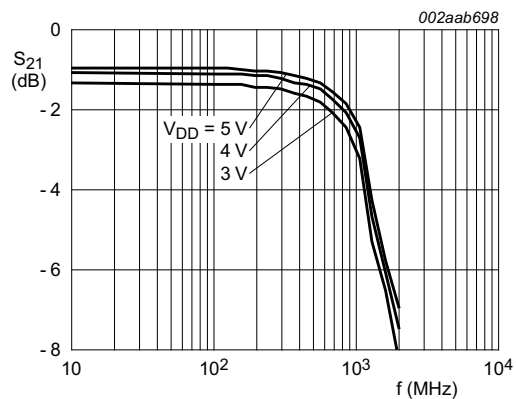
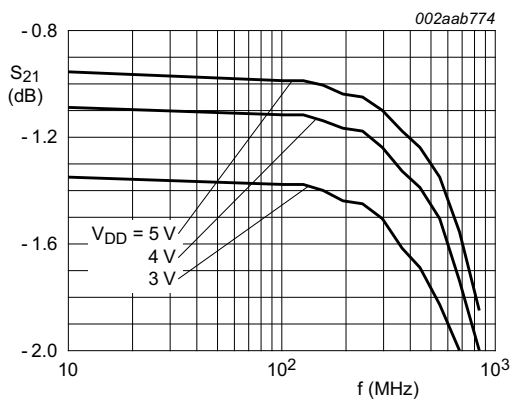
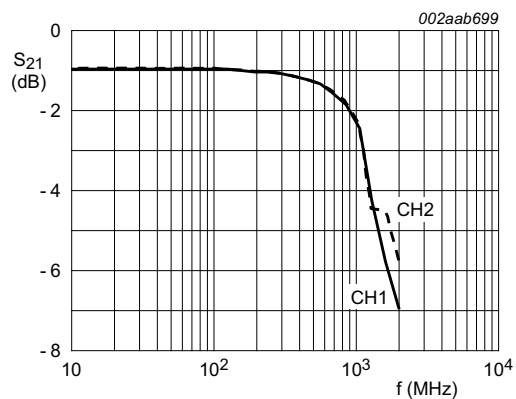
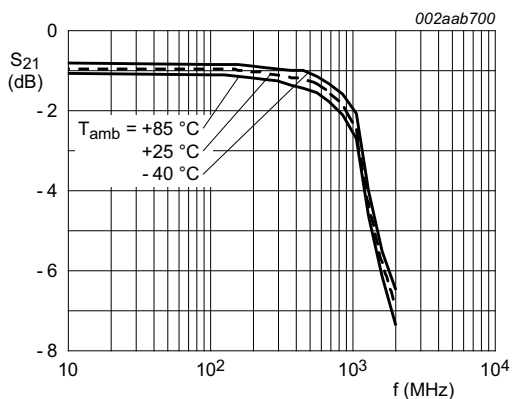
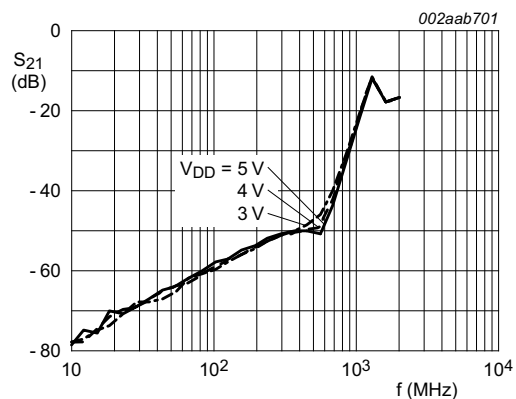
Fig 4. Supply current versus V_{DD} and temperatureFig 5. Loss versus frequency and V_{DD} Fig 6. Loss versus frequency and V_{DD} Fig 7. Loss matching versus frequency;
CH1 versus CH2

Fig 8. Loss versus frequency and temperature

Fig 9. Isolation versus frequency and V_{DD}

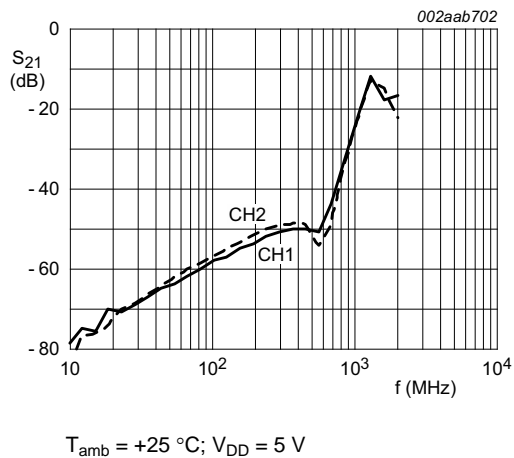


Fig 10. Isolation matching versus frequency; CH1 versus CH2

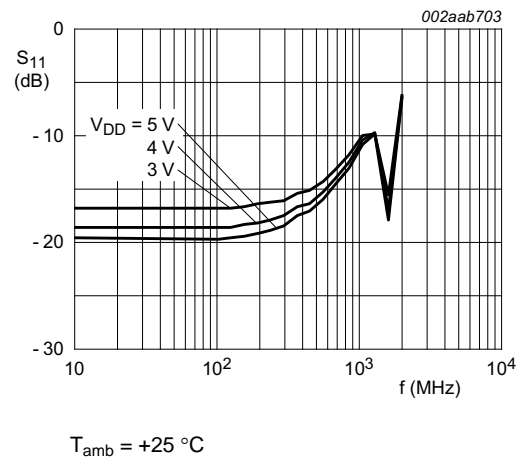


Fig 11. Input match ON-channel versus frequency and V_{DD}

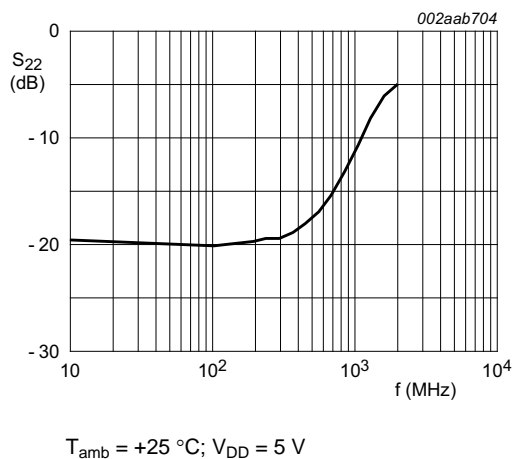


Fig 12. Output match ON-channel versus frequency

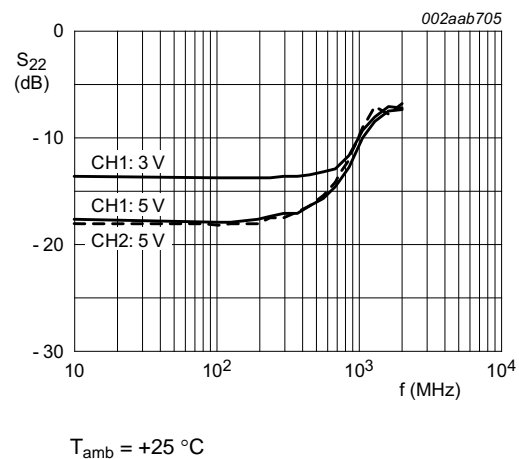


Fig 13. OFF-channel match versus frequency and V_{DD}

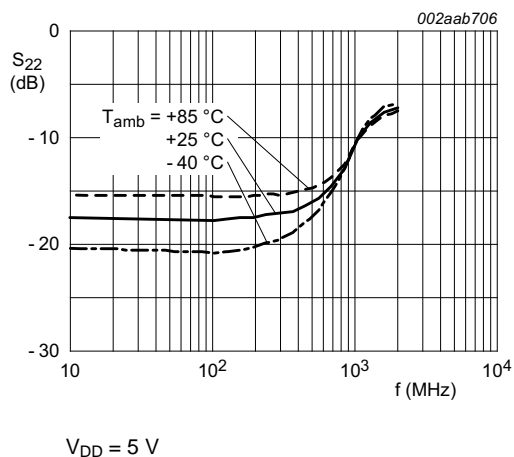


Fig 14. OFF-channel match versus frequency and temperature

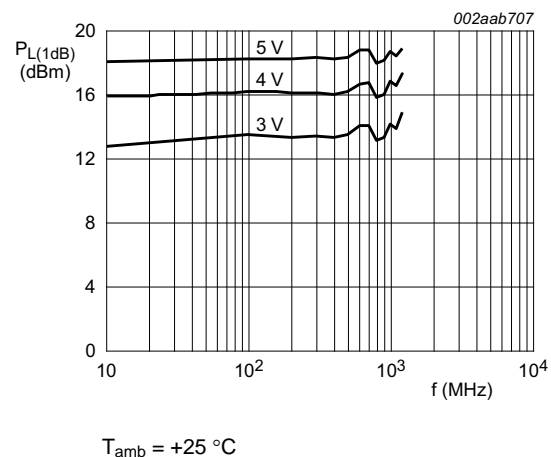
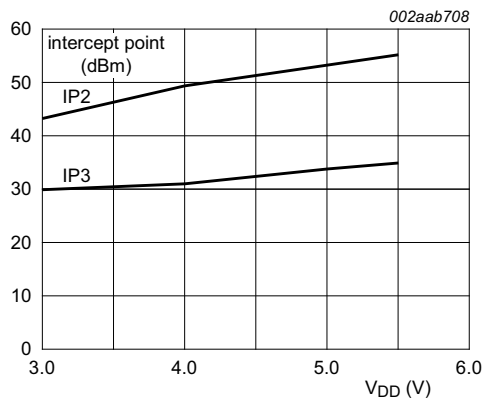
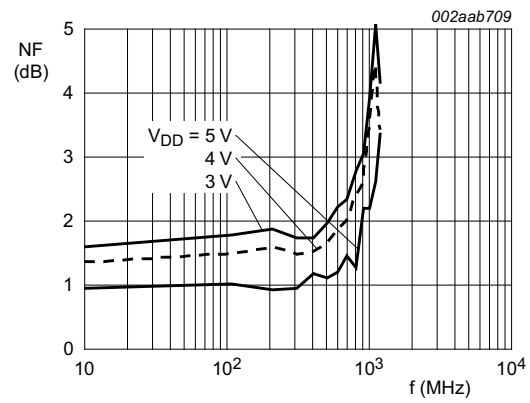


Fig 15. $P_{L(1dB)}$ versus frequency and V_{DD}



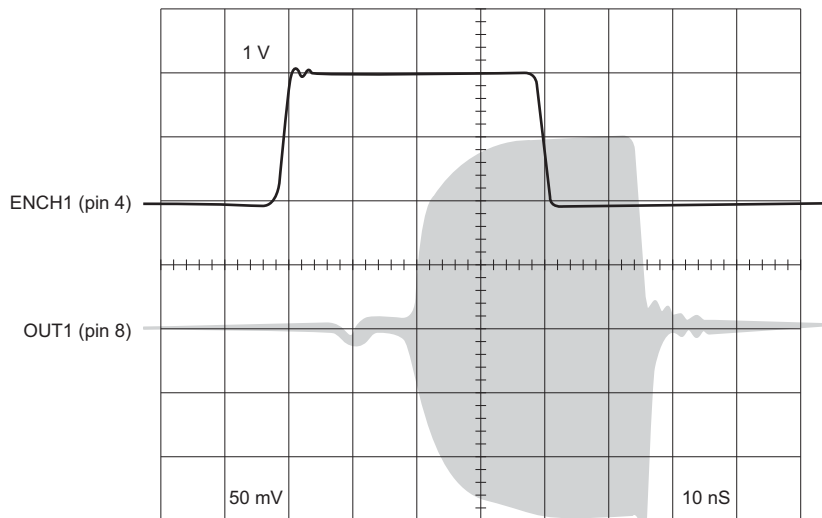
$T_{amb} = +25\text{ }^{\circ}\text{C}$

Fig 16. Intercept points versus V_{DD}



$T_{amb} = +25\text{ }^{\circ}\text{C}; Z_0 = 50\text{ }\Omega$

Fig 17. Noise Figure versus frequency and V_{DD}



aaa-014013

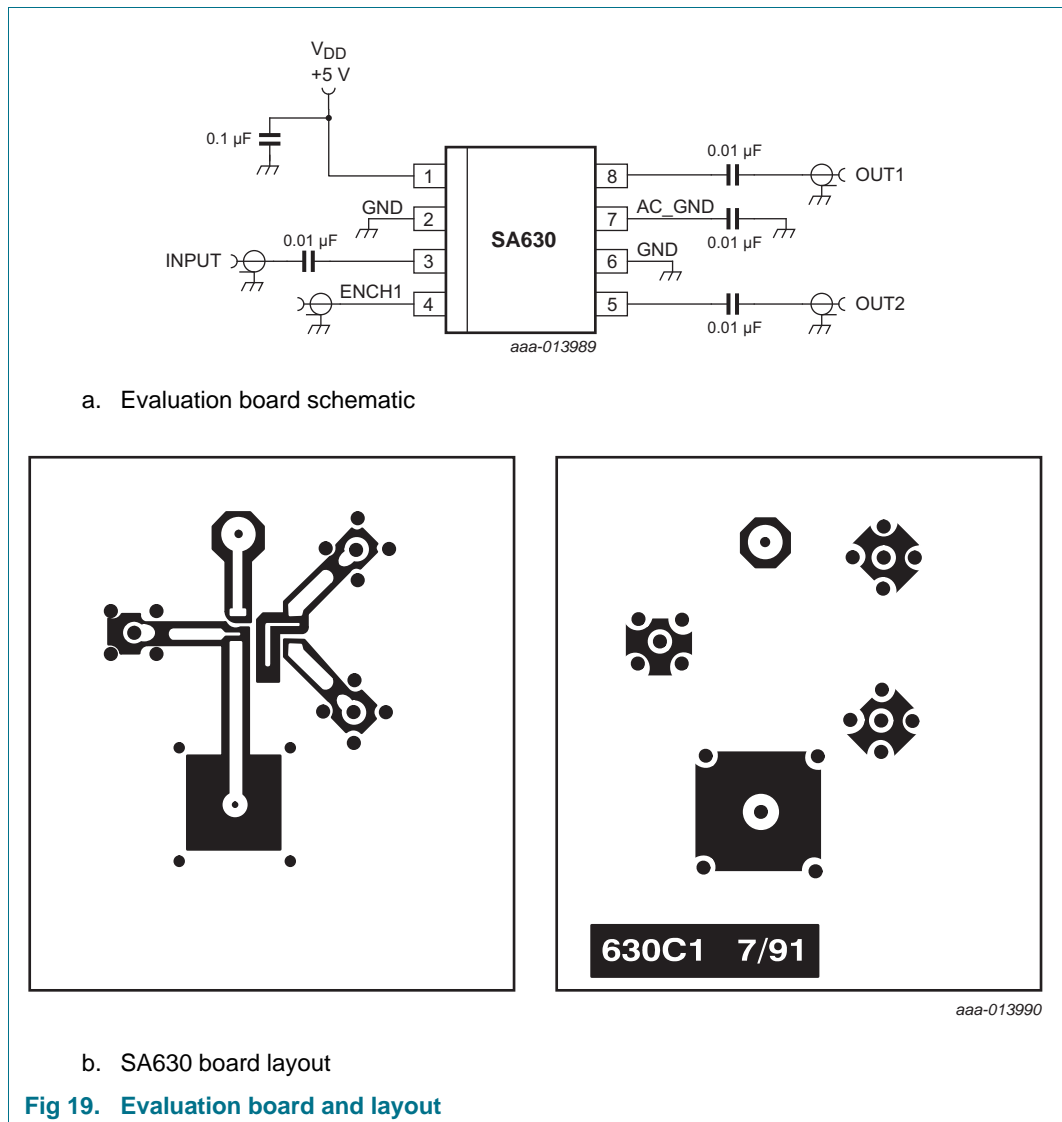
$f_i = 100\text{ MHz at } -6\text{ dBm}; V_{DD} = 5\text{ V}$

Fig 18. Switching speed

14. Application information

The typical application schematic and printed-circuit board layout of the SA630 evaluation board is shown in [Figure 19](#). The layout of the board is simple, but a few cautions must be observed. The input and output traces should be $50\ \Omega$. If a symmetric isolation between the two channels is desired, then the placement of the AC bypass capacitor is **extremely critical**. The trace from AC_GND (pin 7) should be drawn back towards the package and then be routed downwards. The capacitor should be placed straight down as close to the device as practical.

For better isolation between the two channels at higher frequencies, it is also advisable to run the two output/input traces at an angle. This arrangement also minimizes any inductive coupling between the two traces. The power supply bypass capacitor should be placed close to the device. [Figure 5](#) shows the frequency response of the SA630. The loss matching between the two channels is excellent to 1.2 GHz, as shown in [Figure 7](#).



The isolation and matching of the two channels over frequency is shown in [Figure 9](#) and [Figure 10](#), respectively.

The SA630 is a very versatile part and can be used in many applications. [Figure 20](#) shows a block diagram of a typical digital RF transceiver front-end. In this application, the SA630 replaces the duplexer, which is typically very bulky and lossy. Due to the low power consumption of the device, it is ideally suited for handheld applications such as in CT2 cordless telephones. The SA630 can also be used to generate Amplitude Shift Keying (ASK) or On-Off Keying (OOK) and Frequency Shift Keying (FSK) signals for digital RF communications systems. Block diagrams for these applications are shown in [Figure 21](#) and [Figure 22](#), respectively.

For applications that require a higher isolation at 1 GHz than obtained from a single SA630, several SA630s can be cascaded as shown in [Figure 23](#). The cascaded configuration has a higher loss, but greater than 35 dB of isolation at 1 GHz and greater than 65 dB at 500 MHz can be obtained from this configuration. By modifying the enable control, an RF multiplexer/demultiplexer or antenna selector can be constructed. The simplicity of SA630 coupled with its ease of use and high performance lends itself to many innovative applications.

The SA630 switch terminates the OFF channel in 50 Ω . The 50 Ω resistor is internal and is in series with the external AC bypass capacitor. Matching to impedances other than 50 Ω can be achieved by adding a resistor in series with the AC bypass capacitor (for example, 25 Ω additional to match to a 75 Ω environment).

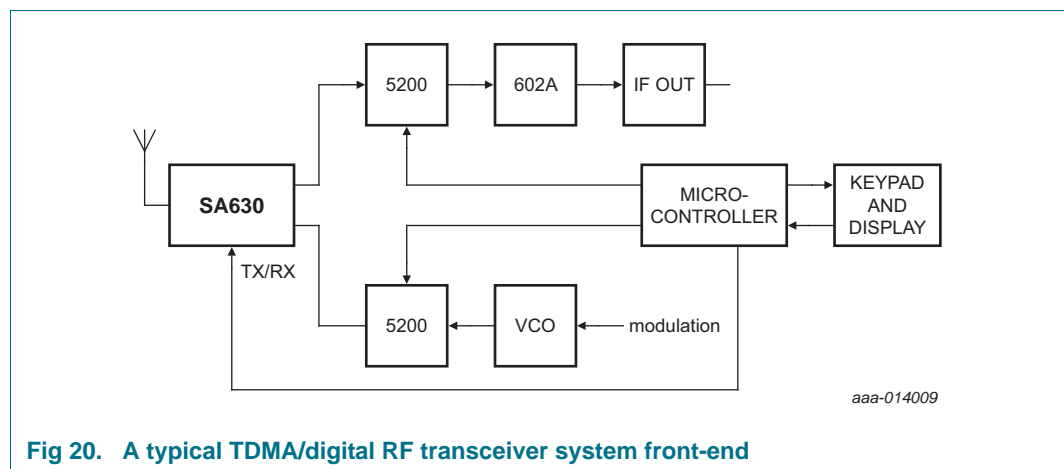


Fig 20. A typical TDMA/digital RF transceiver system front-end

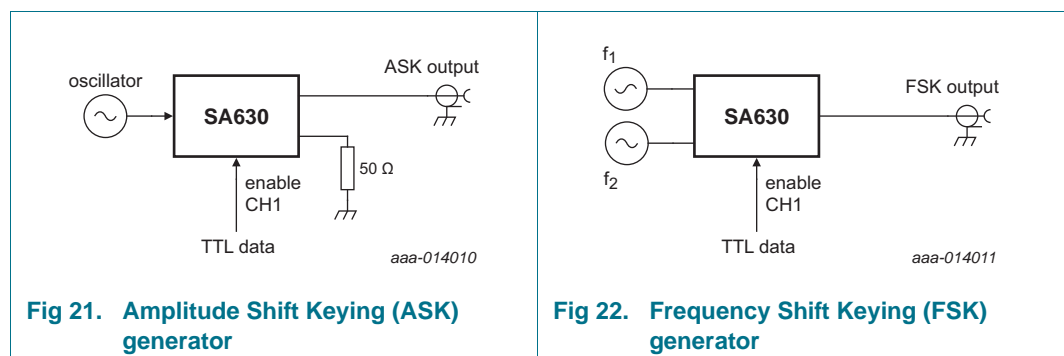
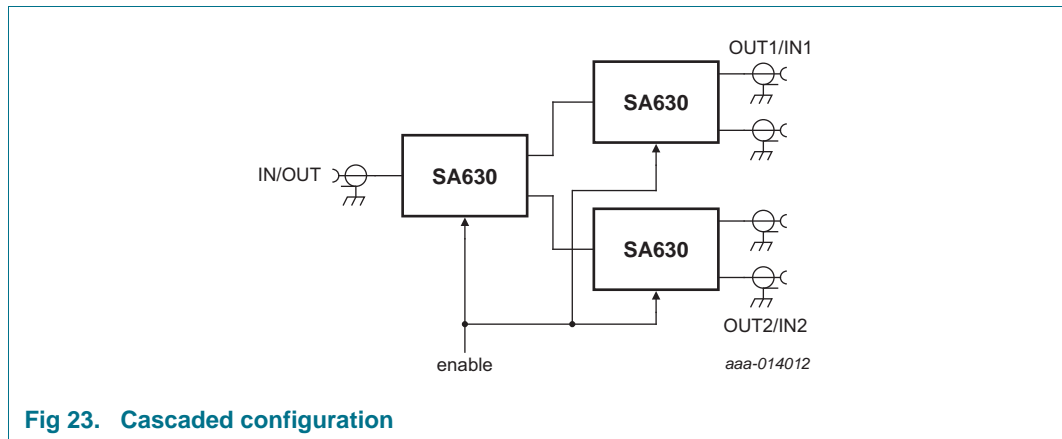


Fig 21. Amplitude Shift Keying (ASK) generator

Fig 22. Frequency Shift Keying (FSK) generator



15. Package outline

SO8: plastic small outline package; 8 leads; body width 3.9 mm

SOT96-1

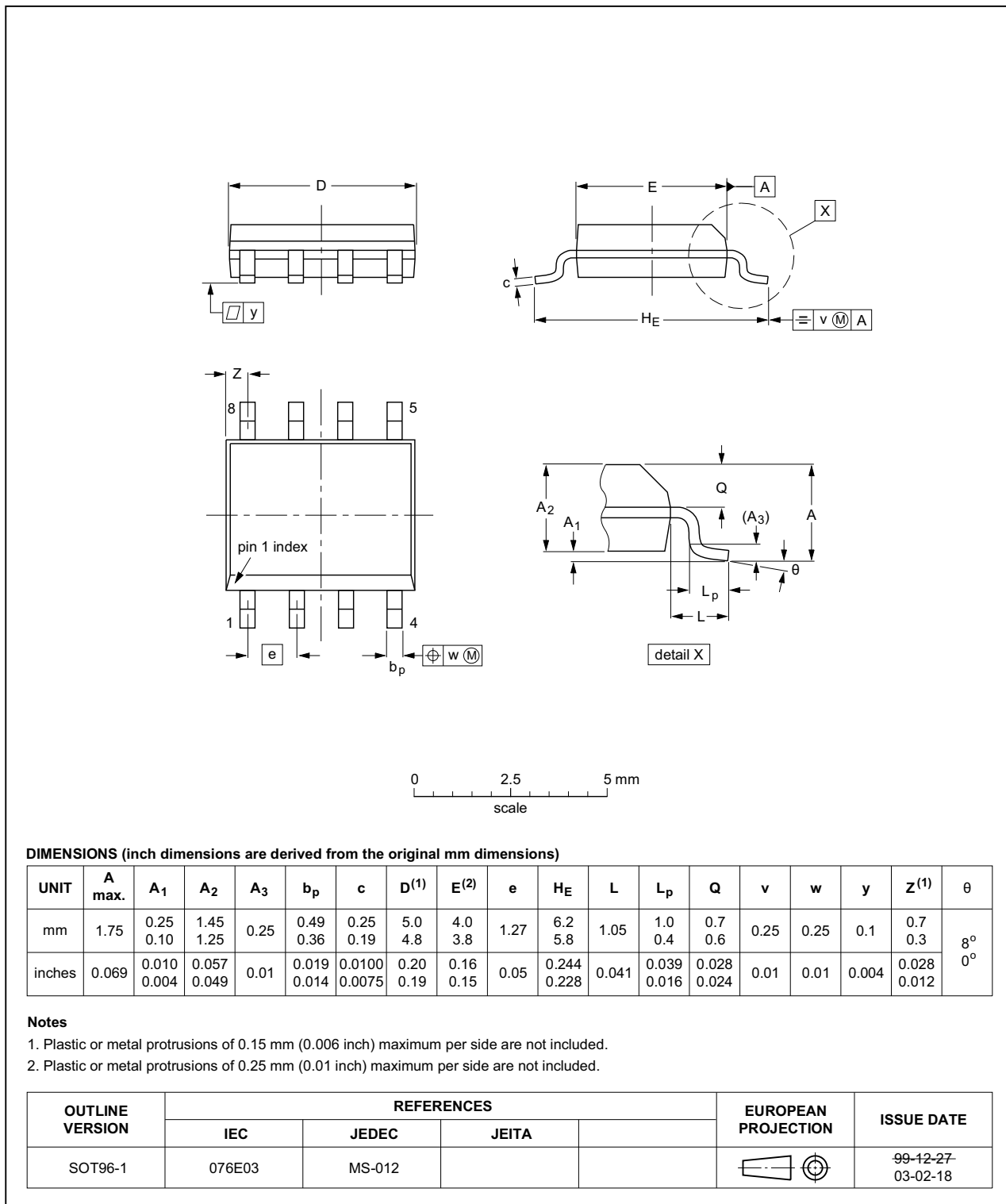


Fig 24. Package outline SOT96-1 (SO8)

16. Soldering of SMD packages

This text provides a very brief insight into a complex technology. A more in-depth account of soldering ICs can be found in Application Note *AN10365 "Surface mount reflow soldering description"*.

16.1 Introduction to soldering

Soldering is one of the most common methods through which packages are attached to Printed Circuit Boards (PCBs), to form electrical circuits. The soldered joint provides both the mechanical and the electrical connection. There is no single soldering method that is ideal for all IC packages. Wave soldering is often preferred when through-hole and Surface Mount Devices (SMDs) are mixed on one printed wiring board; however, it is not suitable for fine pitch SMDs. Reflow soldering is ideal for the small pitches and high densities that come with increased miniaturization.

16.2 Wave and reflow soldering

Wave soldering is a joining technology in which the joints are made by solder coming from a standing wave of liquid solder. The wave soldering process is suitable for the following:

- Through-hole components
- Leaded or leadless SMDs, which are glued to the surface of the printed circuit board

Not all SMDs can be wave soldered. Packages with solder balls, and some leadless packages which have solder lands underneath the body, cannot be wave soldered. Also, leaded SMDs with leads having a pitch smaller than ~0.6 mm cannot be wave soldered, due to an increased probability of bridging.

The reflow soldering process involves applying solder paste to a board, followed by component placement and exposure to a temperature profile. Leaded packages, packages with solder balls, and leadless packages are all reflow solderable.

Key characteristics in both wave and reflow soldering are:

- Board specifications, including the board finish, solder masks and vias
- Package footprints, including solder thieves and orientation
- The moisture sensitivity level of the packages
- Package placement
- Inspection and repair
- Lead-free soldering versus SnPb soldering

16.3 Wave soldering

Key characteristics in wave soldering are:

- Process issues, such as application of adhesive and flux, clinching of leads, board transport, the solder wave parameters, and the time during which components are exposed to the wave
- Solder bath specifications, including temperature and impurities

16.4 Reflow soldering

Key characteristics in reflow soldering are:

- Lead-free versus SnPb soldering; note that a lead-free reflow process usually leads to higher minimum peak temperatures (see [Figure 25](#)) than a SnPb process, thus reducing the process window
- Solder paste printing issues including smearing, release, and adjusting the process window for a mix of large and small components on one board
- Reflow temperature profile; this profile includes preheat, reflow (in which the board is heated to the peak temperature) and cooling down. It is imperative that the peak temperature is high enough for the solder to make reliable solder joints (a solder paste characteristic). In addition, the peak temperature must be low enough that the packages and/or boards are not damaged. The peak temperature of the package depends on package thickness and volume and is classified in accordance with [Table 9](#) and [10](#)

Table 9. SnPb eutectic process (from J-STD-020D)

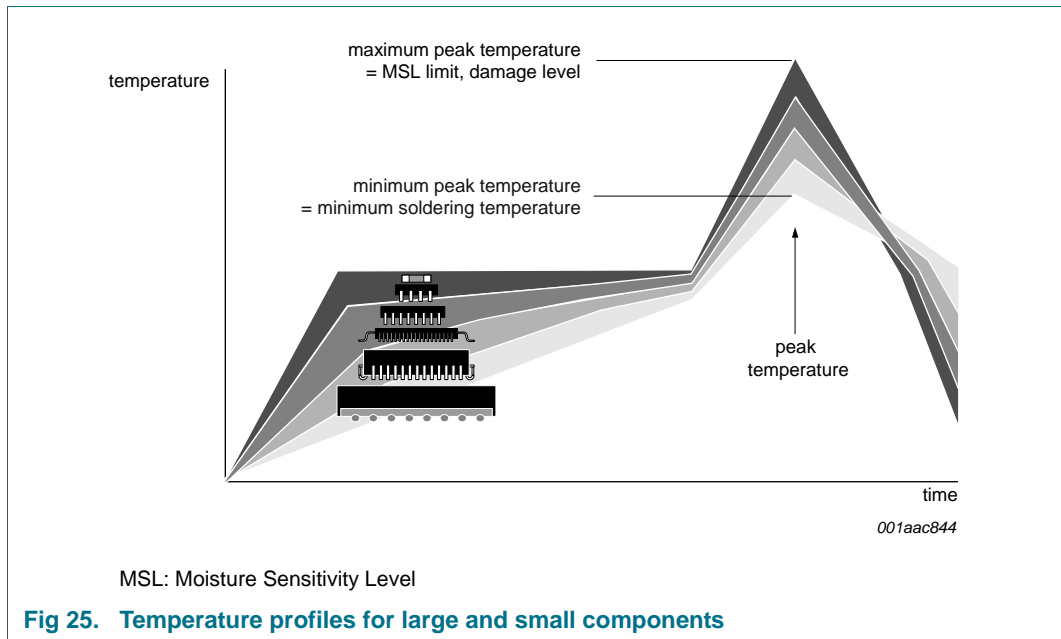
Package thickness (mm)	Package reflow temperature (°C)	
	Volume (mm ³)	
	< 350	≥ 350
< 2.5	235	220
≥ 2.5	220	220

Table 10. Lead-free process (from J-STD-020D)

Package thickness (mm)	Package reflow temperature (°C)		
	Volume (mm ³)		
	< 350	350 to 2000	> 2000
< 1.6	260	260	260
1.6 to 2.5	260	250	245
> 2.5	250	245	245

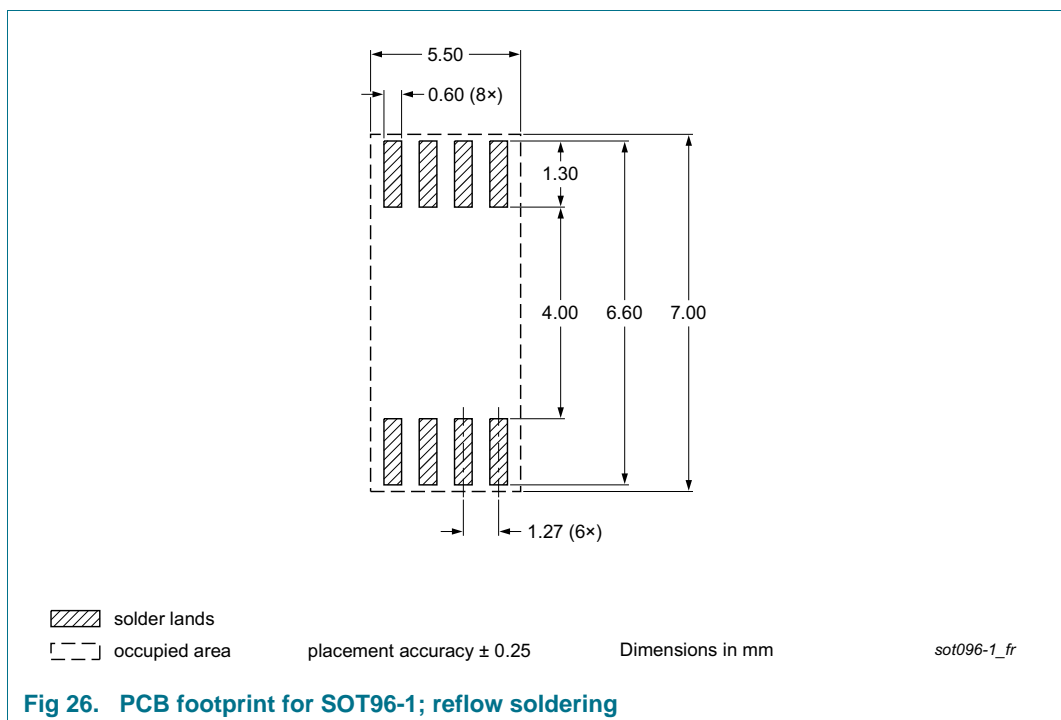
Moisture sensitivity precautions, as indicated on the packing, must be respected at all times.

Studies have shown that small packages reach higher temperatures during reflow soldering, see [Figure 25](#).



For further information on temperature profiles, refer to Application Note AN10365 "Surface mount reflow soldering description".

17. Soldering: PCB footprints



19. Revision history

Table 12. Revision history

Document ID	Release date	Data sheet status	Change notice	Supersedes
SA630 v.3	20140723	Product data sheet	-	SA630 v.2
Modifications:	<ul style="list-style-type: none"> • The format of this data sheet has been redesigned to comply with the new identity guidelines of NXP Semiconductors. • Legal texts have been adapted to the new company name where appropriate. • Type number SA630N is discontinued and removed from this data sheet • Type number SA630D is discontinued and removed from this data sheet • Type number SA630D/01 is added to this data sheet • Added Section 4.1 "Ordering options" • Added Section 6.2 "Pin description" • Added Section 10 "Thermal characteristics" • Deleted (old) "AC ELECTRICAL CHARACTERISTICS - N PACKAGE" • Deleted (old) Figure 4c, "630 N-Package Board Layout" • Deleted (old) Figure 12, "Loss Matching vs. Frequency for N-Package (DIP)" • Deleted (old) Figure 16, "Isolation Matching vs. Frequency for N-Package (DIP)" • Deleted (old) package outline drawing SOT97-1 (DIP8) • Added Section 16 "Soldering of SMD packages" • Added Section 17 "Soldering: PCB footprints" • Added Section 18 "Abbreviations" 			
SA630 v.2	19971107	Product specification	ECN 853-1577 18666	NE/SA630 v.1
NE/SA630 v.1	19911010	Product specification	ECN 853-1577 04269	-

20. Legal information

20.1 Data sheet status

Document status ^{[1][2]}	Product status ^[3]	Definition
Objective [short] data sheet	Development	This document contains data from the objective specification for product development.
Preliminary [short] data sheet	Qualification	This document contains data from the preliminary specification.
Product [short] data sheet	Production	This document contains the product specification.

[1] Please consult the most recently issued document before initiating or completing a design.

[2] The term 'short data sheet' is explained in section "Definitions".

[3] The product status of device(s) described in this document may have changed since this document was published and may differ in case of multiple devices. The latest product status information is available on the Internet at URL <http://www.nxp.com>.

20.2 Definitions

Draft — The document is a draft version only. The content is still under internal review and subject to formal approval, which may result in modifications or additions. NXP Semiconductors does not give any representations or warranties as to the accuracy or completeness of information included herein and shall have no liability for the consequences of use of such information.

Short data sheet — A short data sheet is an extract from a full data sheet with the same product type number(s) and title. A short data sheet is intended for quick reference only and should not be relied upon to contain detailed and full information. For detailed and full information see the relevant full data sheet, which is available on request via the local NXP Semiconductors sales office. In case of any inconsistency or conflict with the short data sheet, the full data sheet shall prevail.

Product specification — The information and data provided in a Product data sheet shall define the specification of the product as agreed between NXP Semiconductors and its customer, unless NXP Semiconductors and customer have explicitly agreed otherwise in writing. In no event however, shall an agreement be valid in which the NXP Semiconductors product is deemed to offer functions and qualities beyond those described in the Product data sheet.

20.3 Disclaimers

Limited warranty and liability — Information in this document is believed to be accurate and reliable. However, NXP Semiconductors does not give any representations or warranties, expressed or implied, as to the accuracy or completeness of such information and shall have no liability for the consequences of use of such information. NXP Semiconductors takes no responsibility for the content in this document if provided by an information source outside of NXP Semiconductors.

In no event shall NXP Semiconductors be liable for any indirect, incidental, punitive, special or consequential damages (including - without limitation - lost profits, lost savings, business interruption, costs related to the removal or replacement of any products or rework charges) whether or not such damages are based on tort (including negligence), warranty, breach of contract or any other legal theory.

Notwithstanding any damages that customer might incur for any reason whatsoever, NXP Semiconductors' aggregate and cumulative liability towards customer for the products described herein shall be limited in accordance with the *Terms and conditions of commercial sale* of NXP Semiconductors.

Right to make changes — NXP Semiconductors reserves the right to make changes to information published in this document, including without limitation specifications and product descriptions, at any time and without notice. This document supersedes and replaces all information supplied prior to the publication hereof.

Suitability for use — NXP Semiconductors products are not designed, authorized or warranted to be suitable for use in life support, life-critical or safety-critical systems or equipment, nor in applications where failure or malfunction of an NXP Semiconductors product can reasonably be expected to result in personal injury, death or severe property or environmental damage. NXP Semiconductors and its suppliers accept no liability for inclusion and/or use of NXP Semiconductors products in such equipment or applications and therefore such inclusion and/or use is at the customer's own risk.

Applications — Applications that are described herein for any of these products are for illustrative purposes only. NXP Semiconductors makes no representation or warranty that such applications will be suitable for the specified use without further testing or modification.

Customers are responsible for the design and operation of their applications and products using NXP Semiconductors products, and NXP Semiconductors accepts no liability for any assistance with applications or customer product design. It is customer's sole responsibility to determine whether the NXP Semiconductors product is suitable and fit for the customer's applications and products planned, as well as for the planned application and use of customer's third party customer(s). Customers should provide appropriate design and operating safeguards to minimize the risks associated with their applications and products.

NXP Semiconductors does not accept any liability related to any default, damage, costs or problem which is based on any weakness or default in the customer's applications or products, or the application or use by customer's third party customer(s). Customer is responsible for doing all necessary testing for the customer's applications and products using NXP Semiconductors products in order to avoid a default of the applications and the products or of the application or use by customer's third party customer(s). NXP does not accept any liability in this respect.

Limiting values — Stress above one or more limiting values (as defined in the Absolute Maximum Ratings System of IEC 60134) will cause permanent damage to the device. Limiting values are stress ratings only and (proper) operation of the device at these or any other conditions above those given in the Recommended operating conditions section (if present) or the Characteristics sections of this document is not warranted. Constant or repeated exposure to limiting values will permanently and irreversibly affect the quality and reliability of the device.

Terms and conditions of commercial sale — NXP Semiconductors products are sold subject to the general terms and conditions of commercial sale, as published at <http://www.nxp.com/profile/terms>, unless otherwise agreed in a valid written individual agreement. In case an individual agreement is concluded only the terms and conditions of the respective agreement shall apply. NXP Semiconductors hereby expressly objects to applying the customer's general terms and conditions with regard to the purchase of NXP Semiconductors products by customer.

No offer to sell or license — Nothing in this document may be interpreted or construed as an offer to sell products that is open for acceptance or the grant, conveyance or implication of any license under any copyrights, patents or other industrial or intellectual property rights.

Export control — This document as well as the item(s) described herein may be subject to export control regulations. Export might require a prior authorization from competent authorities.

Non-automotive qualified products — Unless this data sheet expressly states that this specific NXP Semiconductors product is automotive qualified, the product is not suitable for automotive use. It is neither qualified nor tested in accordance with automotive testing or application requirements. NXP Semiconductors accepts no liability for inclusion and/or use of non-automotive qualified products in automotive equipment or applications.

In the event that customer uses the product for design-in and use in automotive applications to automotive specifications and standards, customer (a) shall use the product without NXP Semiconductors' warranty of the product for such automotive applications, use and specifications, and (b) whenever customer uses the product for automotive applications beyond

NXP Semiconductors' specifications such use shall be solely at customer's own risk, and (c) customer fully indemnifies NXP Semiconductors for any liability, damages or failed product claims resulting from customer design and use of the product for automotive applications beyond NXP Semiconductors' standard warranty and NXP Semiconductors' product specifications.

Translations — A non-English (translated) version of a document is for reference only. The English version shall prevail in case of any discrepancy between the translated and English versions.

20.4 Trademarks

Notice: All referenced brands, product names, service names and trademarks are the property of their respective owners.

21. Contact information

For more information, please visit: <http://www.nxp.com>

For sales office addresses, please send an email to: salesaddresses@nxp.com

22. Contents

1	General description	1
2	Features and benefits	1
3	Applications	1
4	Ordering information	2
4.1	Ordering options	2
5	Block diagram	2
6	Pinning information	3
6.1	Pinning	3
6.2	Pin description	3
7	Equivalent circuit	3
8	Limiting values	4
9	Recommended operating conditions	4
10	Thermal characteristics	4
11	Static characteristics	5
12	Dynamic characteristics	5
13	Performance curves	6
14	Application information	9
15	Package outline	12
16	Soldering of SMD packages	13
16.1	Introduction to soldering	13
16.2	Wave and reflow soldering	13
16.3	Wave soldering	13
16.4	Reflow soldering	14
17	Soldering: PCB footprints	15
18	Abbreviations	16
19	Revision history	17
20	Legal information	18
20.1	Data sheet status	18
20.2	Definitions	18
20.3	Disclaimers	18
20.4	Trademarks	19
21	Contact information	19
22	Contents	20

Please be aware that important notices concerning this document and the product(s) described herein, have been included in section 'Legal information'.

© NXP Semiconductors N.V. 2014.

All rights reserved.

For more information, please visit: <http://www.nxp.com>

For sales office addresses, please send an email to: salesaddresses@nxp.com

Date of release: 23 July 2014

Document identifier: SA630

OUR CERTIFICATE

DiGi provide top-quality products and perfect service for customer worldwide through standardization, technological innovation and continuous improvement. DiGi through third-party certification, we stricly control the quality of products and services. Welcome your RFQ to

Email: Info@DiGi-Electronics.com



Tel: +00 852-30501935

RFQ Email: Info@DiGi-Electronics.com

DiGi is a global authorized distributor of electronic components.