

D6T-1A-02 Datasheet

www.digi-electronics.com



<https://www.DiGi-Electronics.com>

DiGi Electronics Part Number	D6T-1A-02-DG
Manufacturer	Omron Electronics Inc-EMC Div
Manufacturer Product Number	D6T-1A-02
Description	SENSOR DIGITAL -40C-80C MODULE
Detailed Description	Temperature Sensor Digital, Local -40°C ~ 80°C Module



Tel: +00 852-30501935

RFQ Email: Info@DiGi-Electronics.com

DiGi is a global authorized distributor of electronic components.

Purchase and inquiry

Manufacturer Product Number:

D6T-1A-02

Series:

D6T

Sensor Type:

Digital, Local

Sensing Temperature - Remote:

-

Voltage - Supply:

4.5V ~ 5.5V

Features:

-

Test Condition:

-

Mounting Type:

User Defined

Supplier Device Package:

Module

Manufacturer:

Omron Electronics Inc-EMC Div

Product Status:

Active

Sensing Temperature - Local:

-40°C ~ 80°C

Output Type:

I2C

Resolution:

-

Accuracy - Highest (Lowest):

-

Operating Temperature:

-40°C ~ 80°C

Package / Case:

Module

Base Product Number:

D6T-1A

Environmental & Export classification

RoHS Status:

RoHS Compliant

REACH Status:

REACH Unaffected

HTSUS:

9025.19.8085

Moisture Sensitivity Level (MSL):

1 (Unlimited)

ECCN:

EAR99



D6T MEMS Thermal Sensors



Contactless measurement with OMRON
D6T Thermal Sensors
Able to detect the slightest
temperature changes

Contactless Measurement OMRON MEMS Thermal Sensors are able to detect the slightest temperature changes

MEMS Thermal (IR sensor) measures the surface temperature of objects without touching them when the thermopile element absorbs the amount of radiant energy from the object.

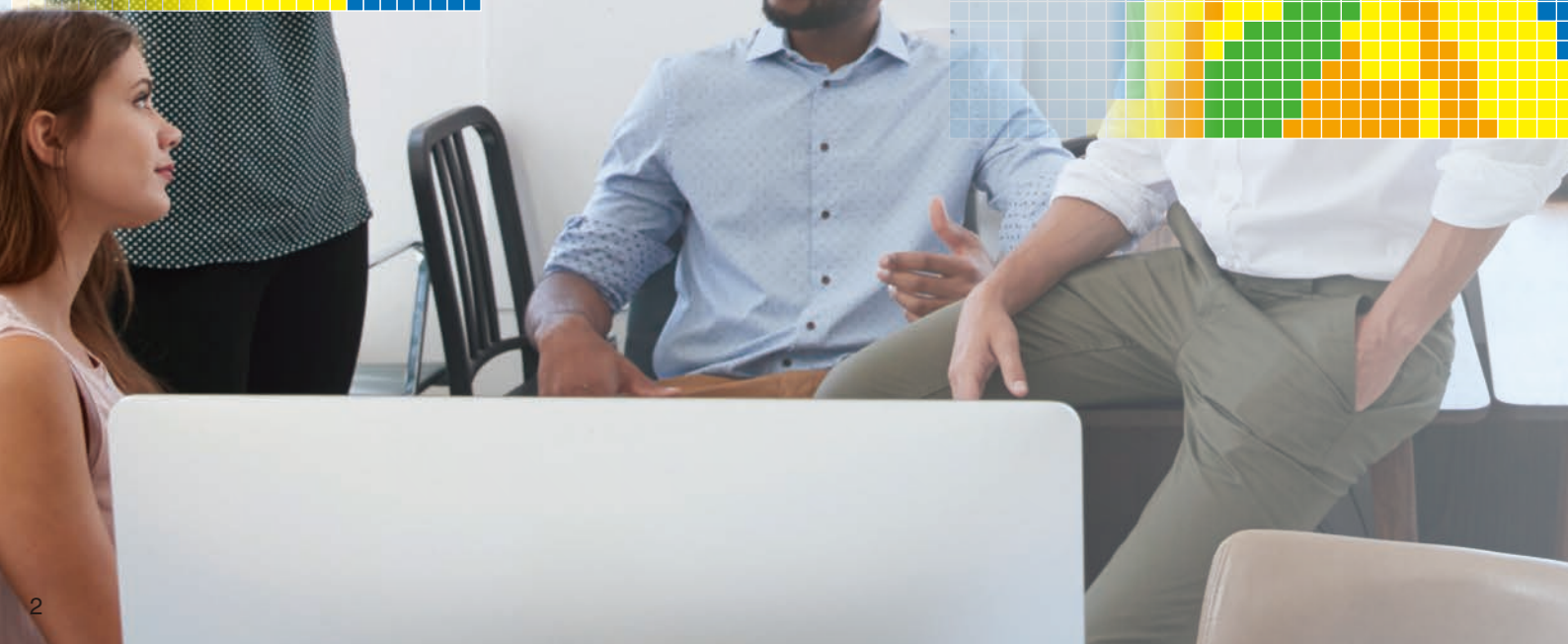
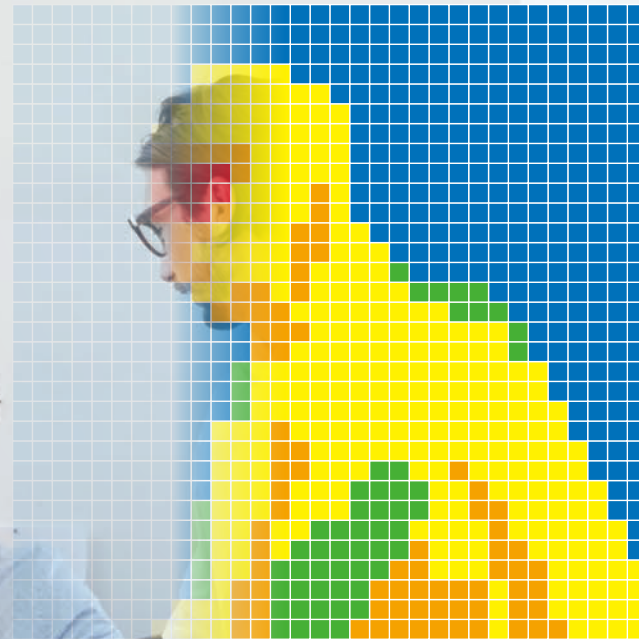
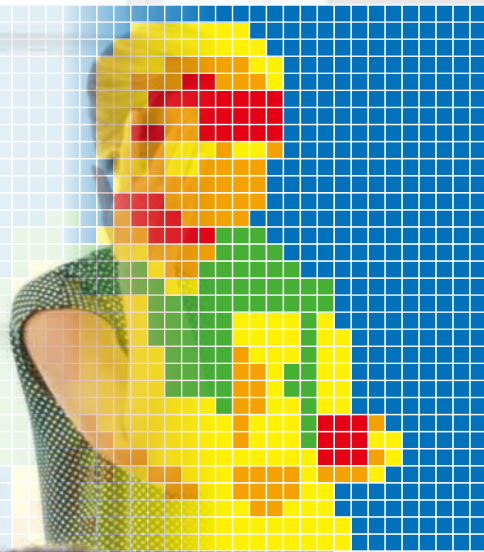

1

Low noise

World's highest-class stable temperature output*

*According to OMRON's research as of February 2021, except for D6T-32L-01A.

2

Easy connection

Direct temperature value output allows easy software design

3

Number of elements and temperature lineup

Variation of the number of elements (1 to 1024) x temperature range (-40 to 200°C)

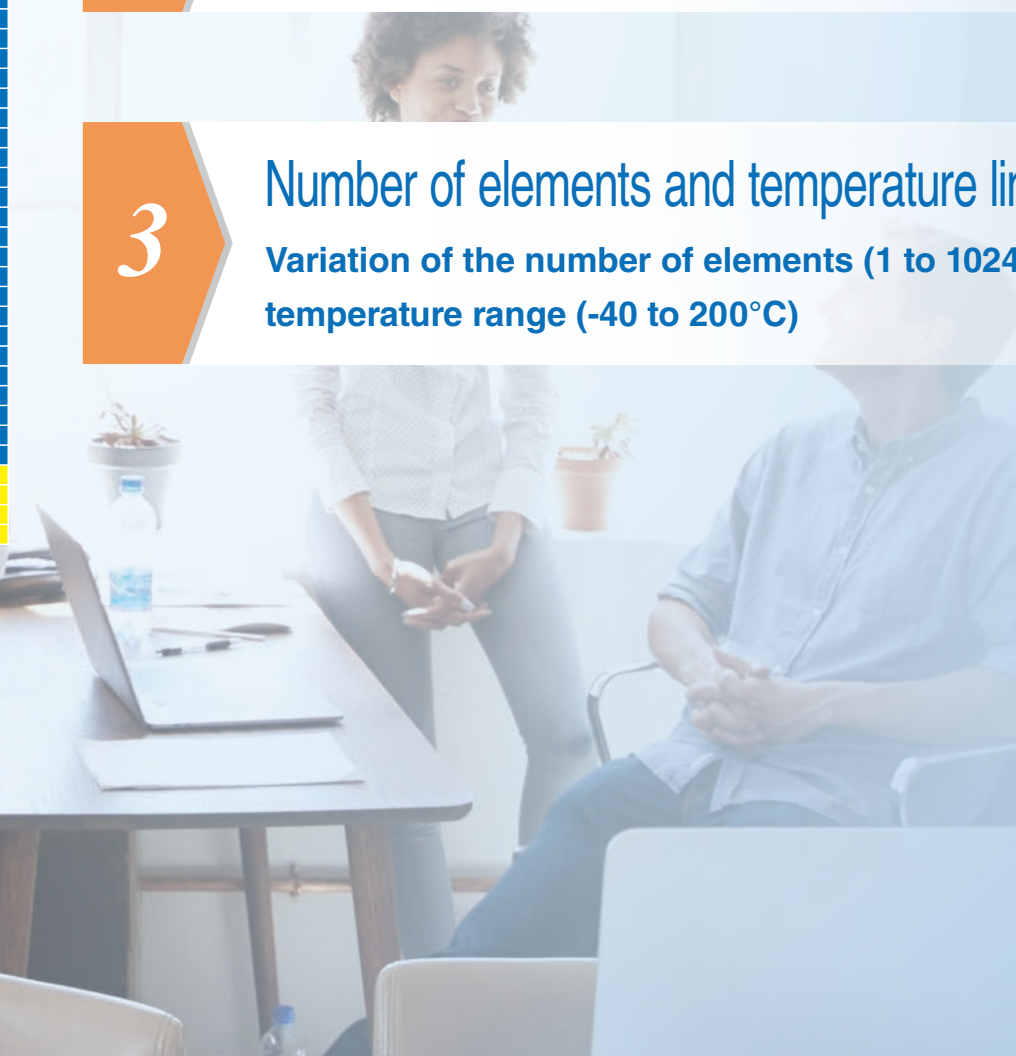



High Precision

World's highest-class stable temperature output*

*According to OMRON's research as of February 2021, except for D6T-32L-01A.

Past problem

Output was unstable in applications requiring high precision



Solution!

Stable temperature output

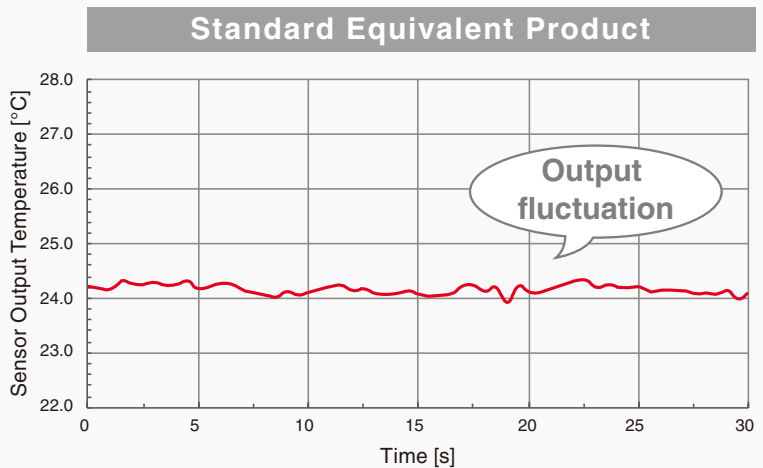
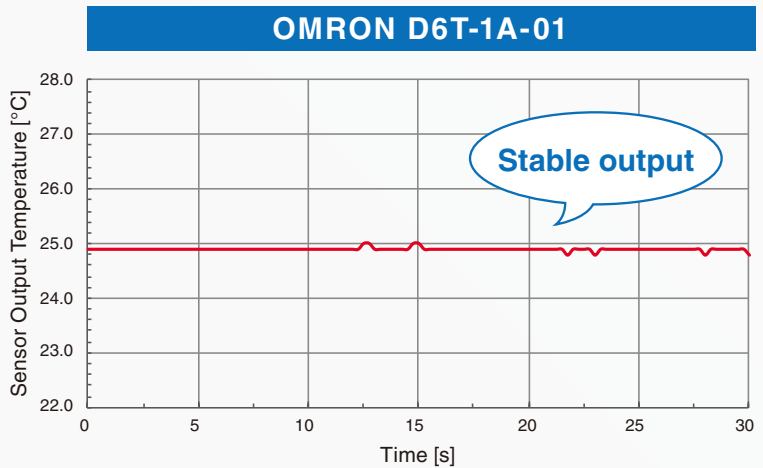
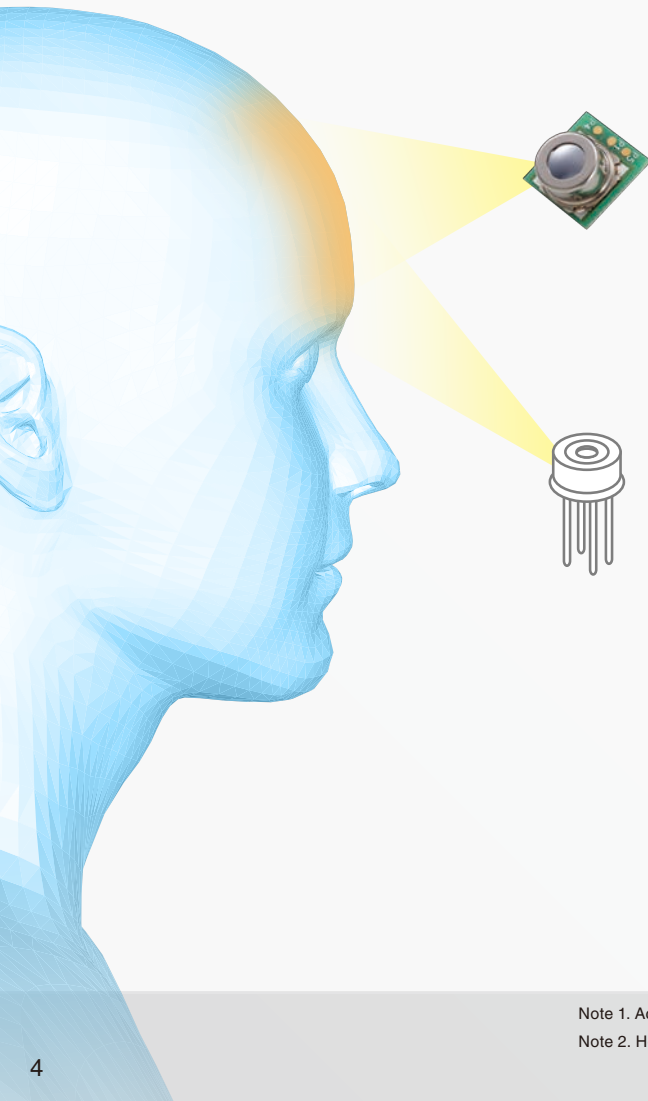

Note 1. According to OMRON's evaluation method (30-second continuous measurement with a blackbody furnace at 25°C)
Note 2. However, product specifications are not guaranteed.

-High Precision- Why?

Achieves the world's highest level*² of SNR*¹
by combining the in-house designed and
manufactured ASIC and MEMS

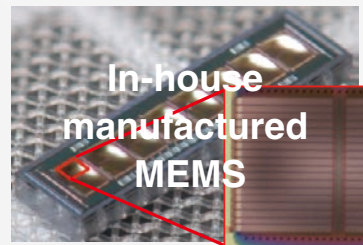
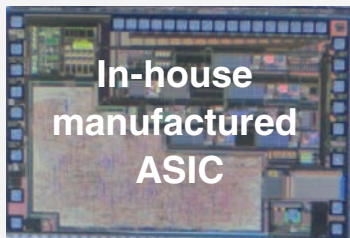

OMRON designs and manufactures both ASIC and MEMS thermopiles in-house. OMRON's unique digital filter and process optimization reduce the noise of ASIC, achieving the world's highest-level SNR.

*1 SNR: Signal-to-Noise Ratio. Compares the level of a signal to the level of background noise.

*2 According to OMRON's research as of February 2021, except for D6T-32L-01A.

Product Structure

OMRON's unique MEMS technology allows combining thermopile elements and ASICs into one package, resulting in ultra-compact footprint and high precision.

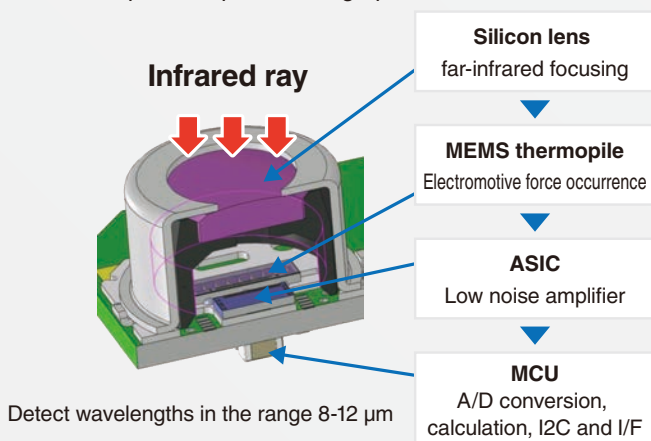

MEMS thermopile detection principle

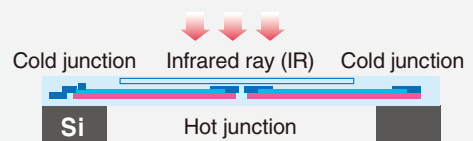

The sensor utilizes the seebeck effect in which thermoelectric force is generated due to the temperature difference that occurs across the junction points of two different types of metal.

2

Easy connection

Direct temperature value output allows easy software design

OMRON D6T

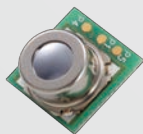

Temperature value output

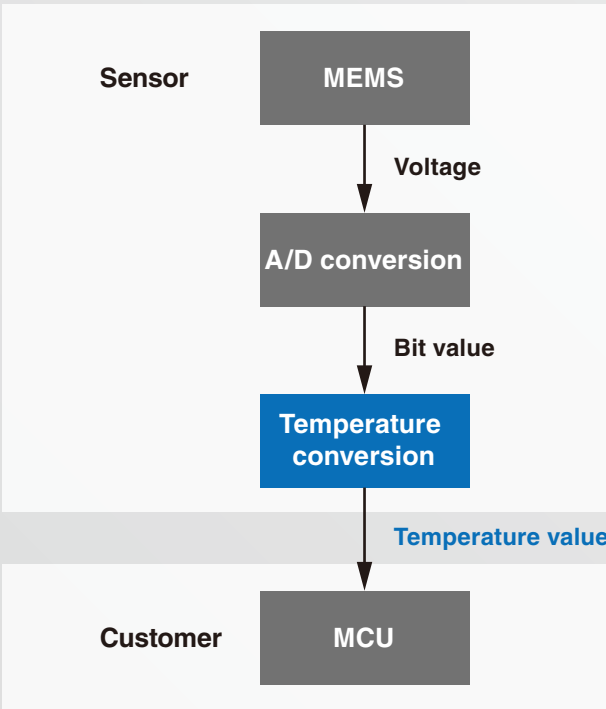

CAN packaged thermal sensor from a competitor



Bit value output

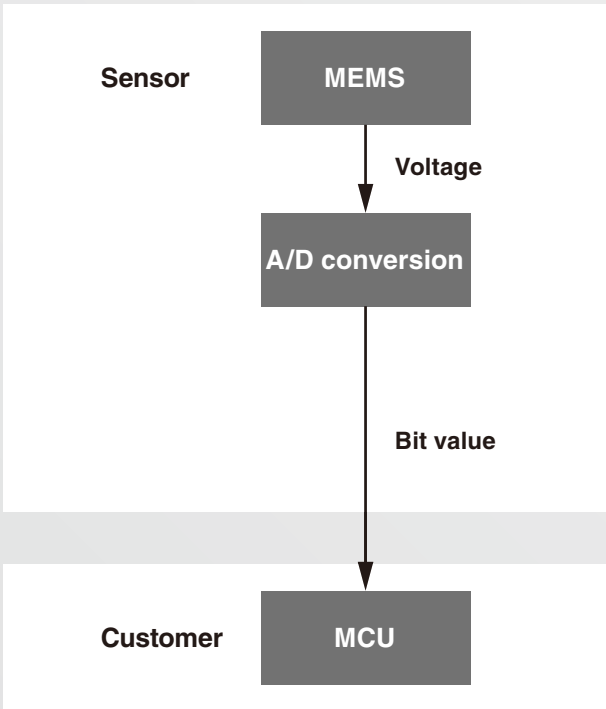

Provision of Development Support Tool

MEMS thermal sensors can be connected to **OMRON sensor evaluation boards**. The below 3 types of platform are applicable. Evaluation can be performed easily by connecting thermal sensor, evaluation board, and harness to the platform.

Sensor	Harness for Connection	Evaluation Board	Platform	Sample Code
D6T	2JCIE-HARNESS-01	2JCIE-EV01-RP1	Raspberry Pi ^{*1}	https://github.com/omron-devhub/d6t-2jcieev01-raspberrypi
		2JCIE-EV01-AR1	Arduino ^{*2}	https://github.com/omron-devhub/d6t-2jcieev01-arduino
		2JCIE-EV01-FT1	ESP32 Feather ^{*3}	https://github.com/omron-devhub/d6t-2jcieev01-arduino

*1. Raspberry Pi is a registered trademark of the Raspberry Pi Foundation. *2. Arduino is a registered trademark of Arduino LLC and Arduino SRL. *3. Feather is a registered trademark of Adafruit Industries LLC.

3

Number of elements and temperature lineup

Variation of the number of elements (1 to 1024) and the temperature range (-40 to 200°C)

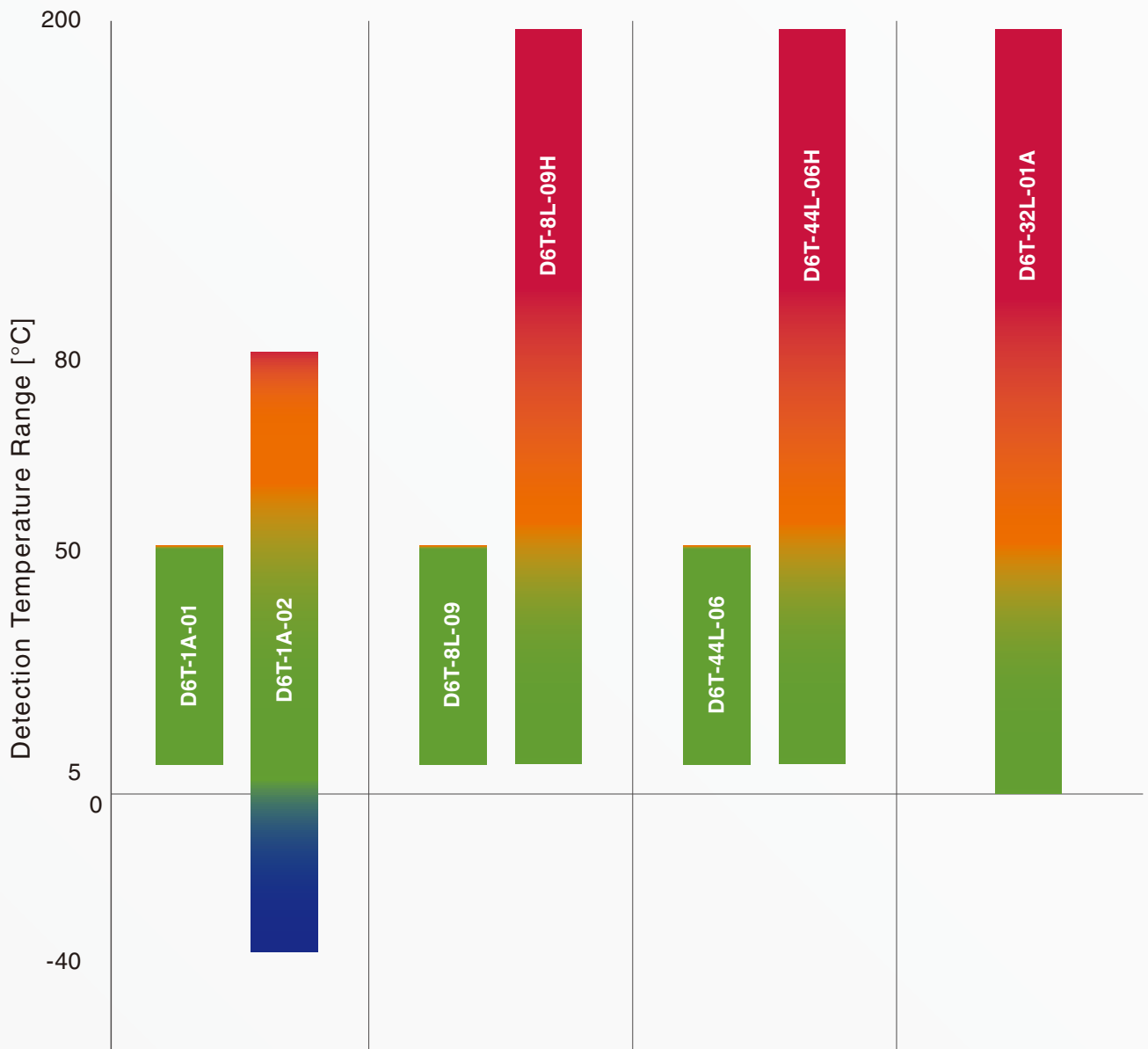
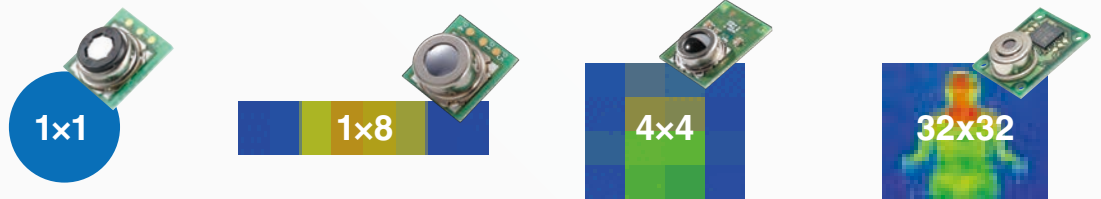

Example Applications

The sensors can be used in a wide range of applications, depending on the temperature measurement range.

-40°C

Refrigerator Interior & Room Temperature Detection

Able to detect temperature from a long distance



Home appliances (refrigerators & air conditioners)

Recommended Models



Human Presence Detection

Able to detect stationary human presence



Air conditioners & lighting systems

Recommended Models

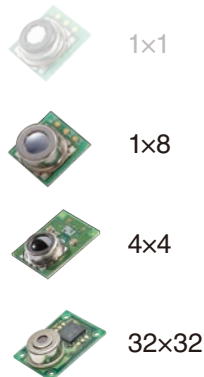

Screening of Humans with Fever

Contributes to automated non-contact temperature detection

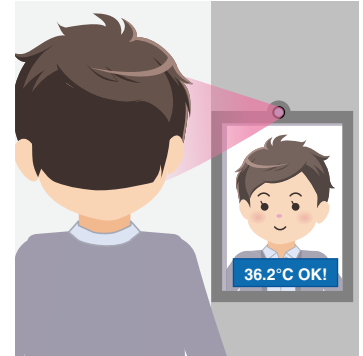

Room-Entry Management Equipment

Recommended Models



200°C



Abnormal High Temperature Monitoring

Contributes to prevention of fires due to overheating



Transformers & distribution boards

Recommended Models

-  1x1
-  1x8
-  4x4
-  32x32

Comparison with Pyroelectric Sensor

Both the pyroelectric sensor and non-contact MEMS thermal sensor can detect even the slightest amount of radiant energy from objects such as infrared radiation and convert them into temperature readings. However, unlike pyroelectric sensor that relies on motion detection, non-contact MEMS thermal sensor is able to detect the presence of stationary humans (or objects).

Pyroelectric sensor

Converts temperature readings only when detecting “temperature changes in the radiant energy” in its field of view.

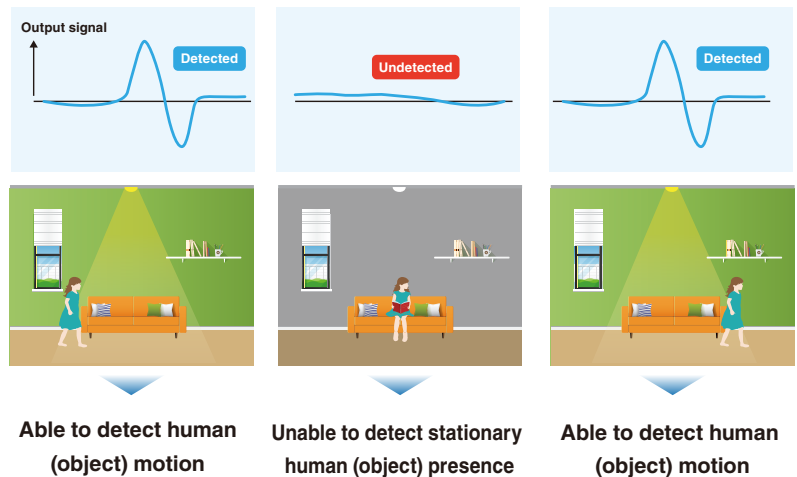



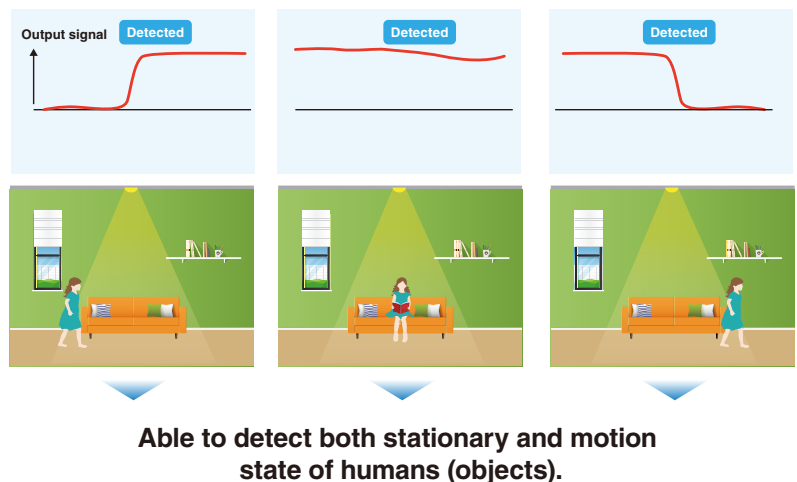

MEMS thermal sensor (thermopile)

Converts temperature readings by “continuously detecting the temperature of radiant energy” in its field of view



Viewing Angle and Measurement Area

Choose your preferred sensor viewing angle to meet your application needs.

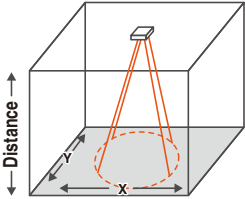
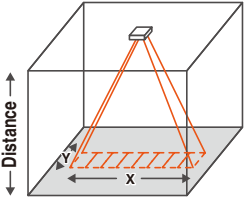
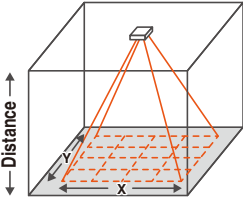
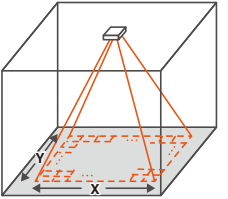
Model	D6T-1A-01	D6T-1A-02	D6T-8L-09	D6T-8L-09H	D6T-44L-06	D6T-44L-06H	D6T-32L-01A
Appearance							
Number of elements	1(1x1)		8(1x8)		16(4x4)		1024(32x32)
Viewing angle X-direction Y-direction	X = 58.0° Y = 58.0°	X = 26.5° Y = 26.5°	X = 54.5° Y = 5.5°		X=44.2° Y=45.7°		X=90.0° Y=90.0°
Size of measurement area							
Distance 10 cm	X = 11 cm Y = 11 cm	X = 4.7 cm Y = 4.7 cm	X = 10 cm Y = 1.0 cm		X = 8.1 cm Y = 8.4 cm		X = 20 cm Y = 20 cm
Distance 50 cm	X = 55 cm Y = 55 cm	X = 24 cm Y = 24 cm	X = 52 cm Y = 4.8 cm		X = 41 cm Y = 42 cm		X = 100 cm Y = 100 cm
Distance 1 m	X = 111 cm Y = 111 cm	X = 47 cm Y = 47 cm	X = 103 cm Y = 10 cm		X = 81 cm Y = 84 cm		X = 200 cm Y = 200 cm
Distance 2 m	X = 222 cm Y = 222 cm	X = 94 cm Y = 94 cm	X = 206 cm Y = 20 cm		X = 162 cm Y = 169 cm		X = 400 cm Y = 400 cm
Distance 3 m	X = 333 cm Y = 333 cm	X = 141 cm Y = 141 cm	X = 309 cm Y = 30 cm		X = 244 cm Y = 253 cm		X = 600 cm Y = 600 cm

*. The sizes of measurement areas indicated above are for reference only.

*. The size of the measurement area changes according to sensor mounting angle

D6T

MEMS Thermal Sensors

MEMS Non-Contact Thermal Sensor for Contactless Measurement

- Achieves the world's highest level² of SNR¹ by combining the in-house designed and manufactured ASIC and MEMS
- Direct temperature value output allows easy software design
- Variation of the number of elements (1 to 1024) and the temperature range (-40 to 200°C)

*1. SNR: Signal-to-Noise Ratio. Compares the level of a signal to the level of background noise.
 *2. According to OMRON's research as of February 2021, except for D6T-32L-01A.

RoHS CompliantRefer to *Safety Precautions* on page 18.

Ordering Information

Thermal Sensors

Element type	Model	Shape
1×1	D6T-1A-01	
	D6T-1A-02	
1×8	D6T-8L-09	
	D6T-8L-09H	
4×4	D6T-44L-06	
	D6T-44L-06H	
32×32	D6T-32L-01A	

Accessories (Sold separately)

Type	Model
Cable Harness	D6T-HARNESS-02

Others

MEMS thermal sensors can be connected to OMRON sensor evaluation boards.

The below 3 types of platform are applicable. Evaluation can be performed easily by connecting thermal sensor, evaluation board, and harness to the platform.

Platform	Evaluation Board	Harness for connection (Evaluation Board - D6T)	Sample Source Code
For Raspberry Pi ¹	2JCIE-EV01-RP1	2JCIE-HARNESS-01	https://github.com/omron-devhub/d6t-2jcieev01-raspberrypi
For Arduino ²	2JCIE-EV01-AR1	2JCIE-HARNESS-01	https://github.com/omron-devhub/d6t-2jcieev01-arduino
For ESP32 Feather ³	2JCIE-EV01-FT1	2JCIE-HARNESS-01	https://github.com/omron-devhub/d6t-2jcieev01-arduino

For details of evaluation boards and sample source codes, refer to the following website.

<https://components.omron.com/sensor/evaluation-board/2jcie>

*1. Raspberry Pi is a registered trademark of the Raspberry Pi Foundation.

*2. Arduino is a registered trademark of Arduino LLC and Arduino SRL.

*3. Feather is a registered trademark of Adafruit Industries LLC.

Model Number Legend

D6T-□-□ □
 (1) (2) (3)

(1) Number of elements

1A : 1 (1 × 1)

8L : 8 (1 × 8)

44L : 16 (4 × 4)

32L : 1024 (32 × 32)

(2) Viewing angle

01 : X direction, Y direction=58.0°

02 : X direction, Y direction=26.5°

09 : X direction=54.5°, Y direction=5.5°

06 : X direction=44.2°, Y direction=45.7°

01A : X direction, Y direction=90°

(3) Special Functions

H : High-temperature type

Non-display : Standard sensor

Ratings, Specifications, and Functions

Ratings

Item	Model	D6T-1A-01	D6T-1A-02	D6T-8L-09	D6T-8L-09H	D6T-44L-06	D6T-44L-06H	D6T-32L-01A
Power supply voltage		4.5 to 5.5 VDC						
Storage temperature range		-20 to 80°C	-40 to 80°C	-20 to 80°C (with no icing or condensation)		-10 to 60°C		-20 to 80°C
Operating temperature range		0 to 60°C	-40 to 80°C	0 to 60°C (with no icing or condensation)		0 to 50°C		-10 to 70°C
Storage humidity range		95% max.	95% max.	95% max. (with no icing or condensation)		85% max.		95% max.
Operating humidity range		20% to 95%	20% to 95%	20% to 95% (with no icing or condensation)		20% to 85%		20% to 95%

Characteristics

Item	Model	D6T-1A-01	D6T-1A-02	D6T-8L-09	D6T-8L-09H	D6T-44L-06	D6T-44L-06H	D6T-32L-01A
View angle ^{*1}	X direction	58.0°	26.5°	54.5°		44.2°		90°
	Y direction	58.0°	26.5°	5.5°		45.7°		90°
Object temperature output accuracy ^{*2}	Accuracy 1	±1.5°C max. Measurement conditions: Vcc = 5.0 V (1) Tx = 25°C, Ta = 25°C (2) Tx = 45°C, Ta = 25°C (3) Tx = 45°C, Ta = 45°C						Within ±3.0°C Measurement conditions: Vcc = 5.0 V Tx = 25°C, Ta = 25°C Central 16x16-pixel area
Current consumption		3.5 mA typical		5 mA typical			19 mA typical	

Functions

Item	Model	D6T-1A-01	D6T-1A-02	D6T-8L-09	D6T-8L-09H	D6T-44L-06	D6T-44L-06H	D6T-32L-01A
Object temperature detection range ^{*2}		5 to 50°C	-40 to 80°C	5 to 50°C	5 to 200°C	5 to 50°C	5 to 200°C	0 to 200°C
Ambient temperature detection range ^{*2}		5 to 45°C	-40 to 80°C	5 to 45°C	5 to 45°C	5 to 45°C	5 to 45°C	0 to 80°C
Output specifications		Digital values that correspond to the object temperature (Tx) and reference temperature (Ta) are output from a serial communications port.						
Output form (Object temperature detection)		Binary code (10 times the detected temperature (°C))			Binary code (5 times the detected temperature (°C))	Binary code (10 times the detected temperature (°C))		
Output form (Reference temperature inside the sensor)		Binary code (10 times the detected temperature (°C))						
Communications form		I2C compliant						
Temperature resolution (NETD) ^{*3}		0.02°C (Data update cycle 100 msec)	0.06°C (Data update cycle 100 msec)	0.03°C (Data update cycle 250 msec)	0.03°C (Data update cycle 250 msec)	0.06°C (Data update cycle 300 msec)	0.06°C (Data update cycle 300 msec)	0.33°C ^{*4} (Data update cycle 200 msec)

*1. Refer to *Field of View Characteristics*.

*2. Refer to *Object Temperature Detection Range*.

*3. Reference data

*4. Taken to be the average value of the central 4 pixels.

D6T

MEMS Thermal Sensors

Object Temperature Detection Range

D6T-44L-06, D6T-8L-09, D6T-1A-01

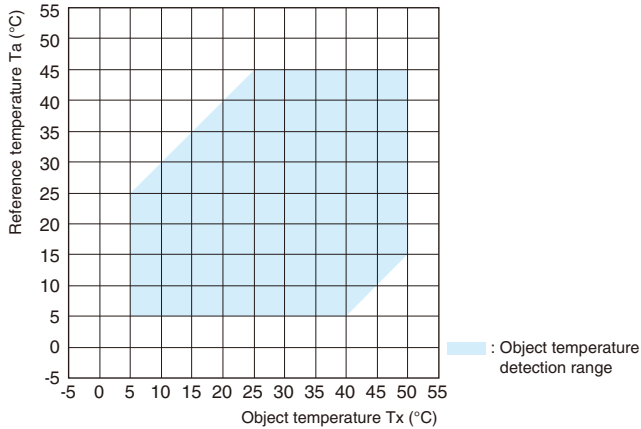

D6T-1A-02

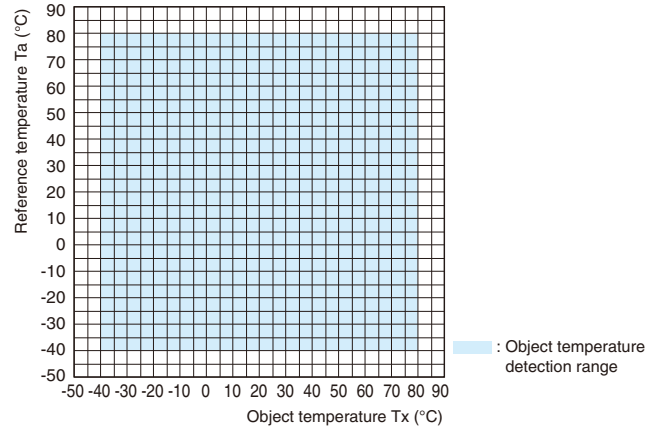

D6T-44L-06H, D6T-8L-09H

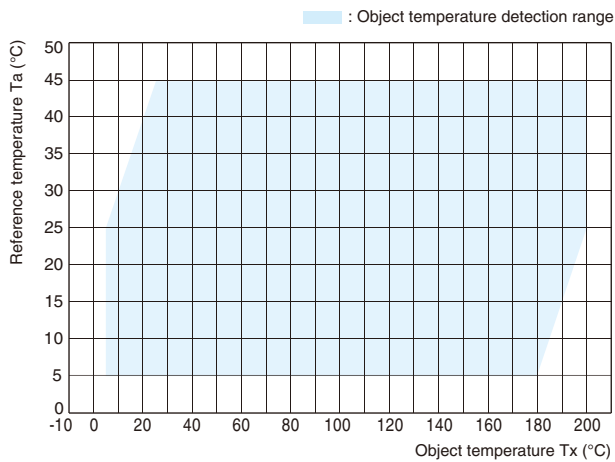

D6T-32L-01A

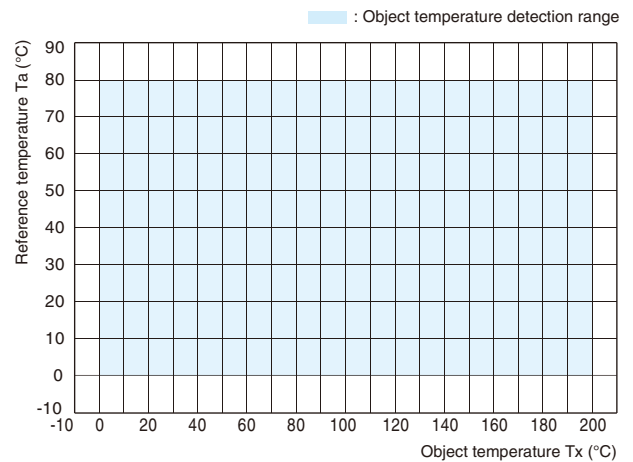

Connections

Thermal Sensor Configuration Diagram

<D6T-8L-09>

<D6T-8L-09H>

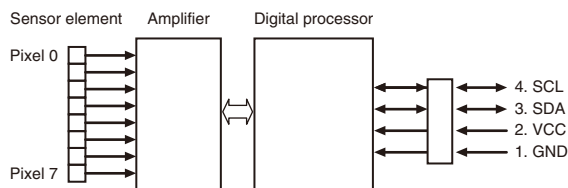

Note: The D6T-44L-06 has pixels 0 to 15.
 The D6T-44L-06H has pixels 0 to 15.
 The D6T-1A-01 has pixel 0.
 The D6T-1A-02 has pixel 0.
 The D6T-32L-01A has pixel 0 to 1023.

Terminal Arrangement

Terminal	Name	Function	Remarks
1	GND	Ground	
2	VCC	Positive power supply voltage input	
3	SDA	Serial data I/O line	Connect the open-drain SDA terminal to a pull-up resistor.
4	SCL	Serial clock input	Connect the open-drain SCL terminal to a pull-up resistor.

D6T

MEMS Thermal Sensors

Field of View Characteristics

D6T-44L-06

D6T-44L-06H

Field of View in X Direction

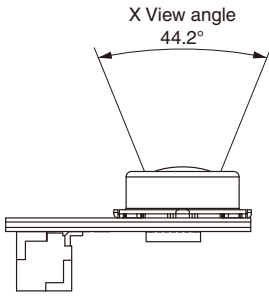

Field of View in Y Direction

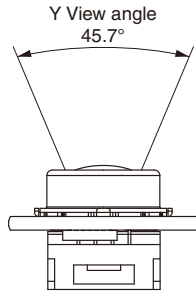

Detection Area for Each Pixel

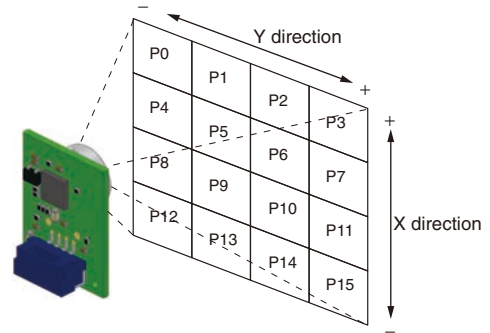

Note: Definition of view angle: Using the maximum sensor output as a reference, the angular range where the Sensor output is 50% or higher when the angle of the Sensor is changed is defined as the View angle.

D6T-8L-09

D6T-8L-09H

Field of View in X Direction

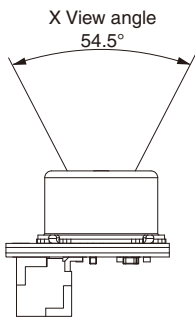

Field of View in Y Direction

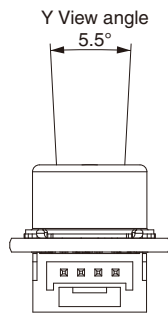

Detection Area for Each Pixel

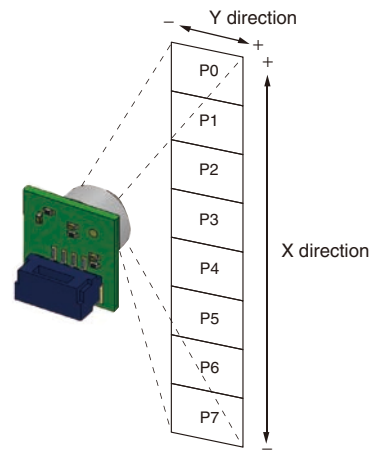

Note: Definition of view angle: Using the maximum Sensor output as a reference, the angular range where the Sensor output is 50% or higher when the angle of the Sensor is changed is defined as the view angle.

D6T

MEMS Thermal Sensors

D6T-1A-01

Field of View in X Direction

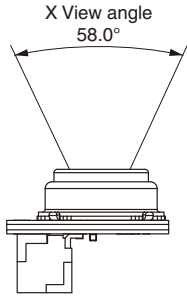

Field of View in Y Direction

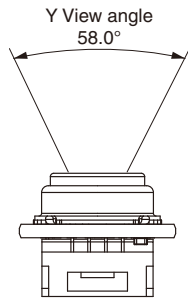

D6T-1A-02

Field of View in X Direction

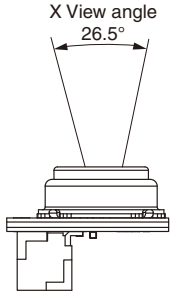

Field of View in Y Direction

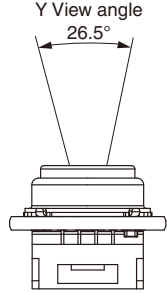

Note: Definition of view angle: Using the maximum Sensor output as a reference, the angular range where the Sensor output is 50% or higher when the angle of the Sensor is changed is defined as the view angle.

Detection Area for Each Pixel

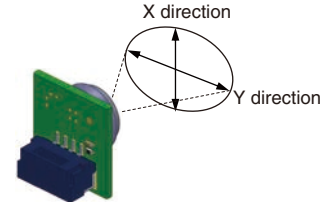

D6T-32L-01A

Field of View in X Direction

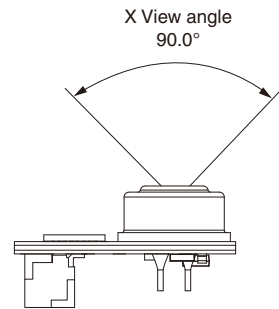

Field of View in Y Direction

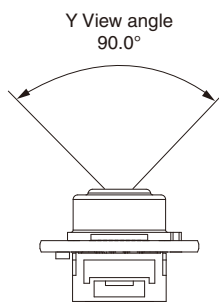

Note: Definition of view angle: Using the maximum Sensor output as a reference, the angular range where the Sensor output is 50% or higher when the angle of the Sensor is changed is defined as the view angle.

Detection Area for Each Pixel

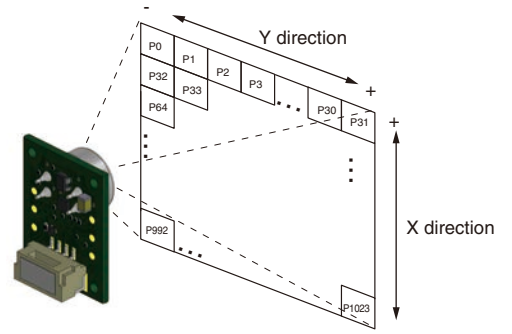

D6T

D6T

MEMS Thermal Sensors

Dimensions

CAD Data Please visit our CAD Data website, which is noted on the last page.

(Unit: mm)

D6T-44L-06
D6T-44L-06H

CAD Data

Supporting and Mounting Area (Shaded Portion)
Top View

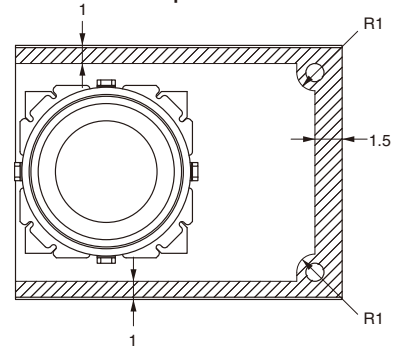
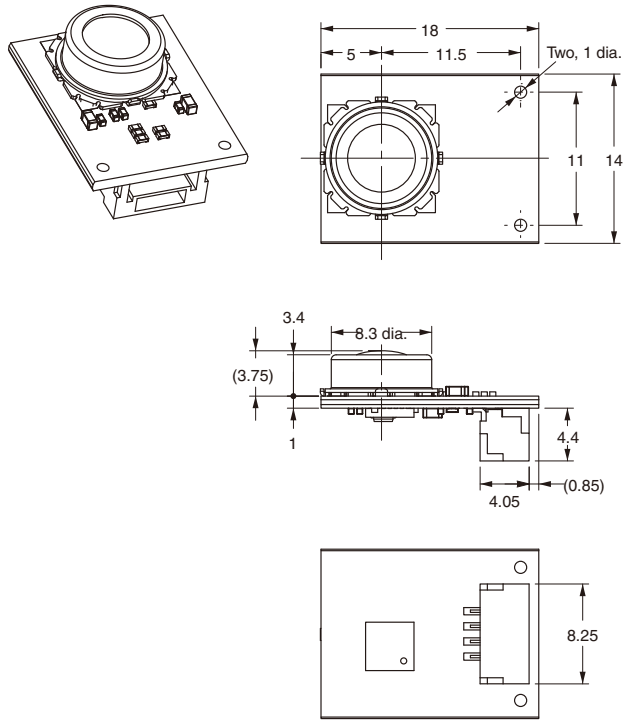

Bottom View

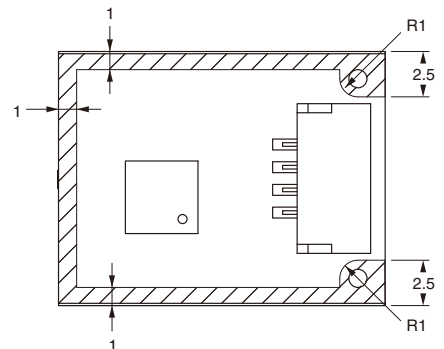
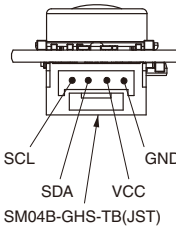

Note: Due to insulation distance limitations, do not allow metal parts to come into contact with the Sensor.

D6T-8L-09
D6T-8L-09H

CAD Data

Supporting and Mounting Area (Shaded Portion)
Top View

D6T

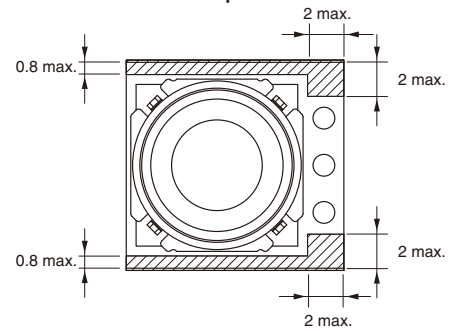
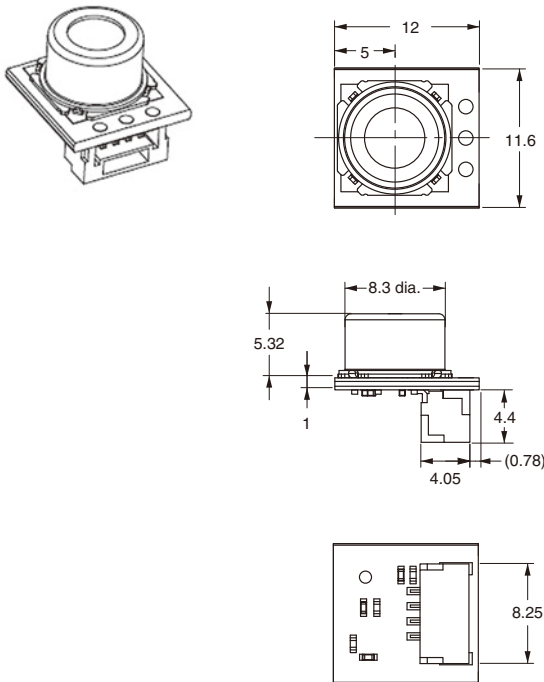

Bottom View

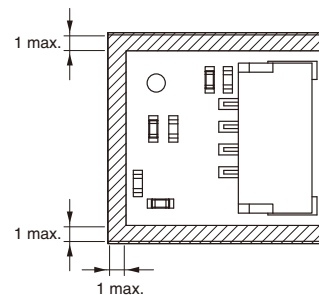
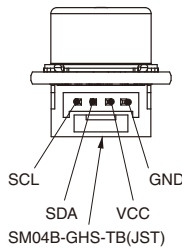

Note: Due to insulation distance limitations, do not allow metal parts to come into contact with the Sensor.

Note: Unless otherwise specified, a tolerance of ± 0.3 mm applies to all dimensions.

D6T

MEMS Thermal Sensors

D6T-1A-01
D6T-1A-02

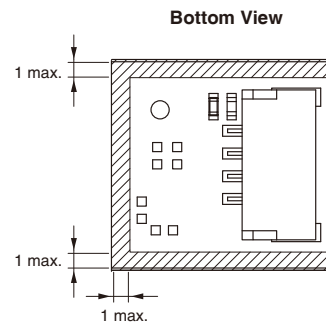
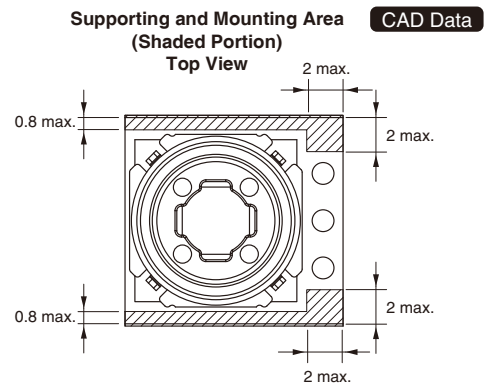
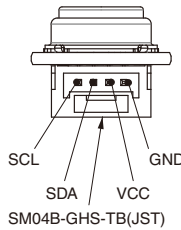
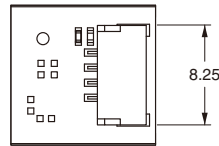
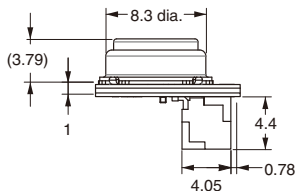
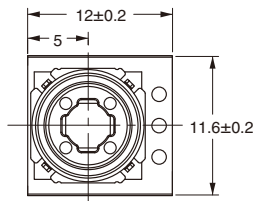
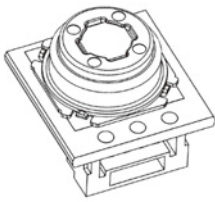

Note: Due to insulation distance limitations, do not allow metal parts to come into contact with the Sensor.

D6T-32L-01A

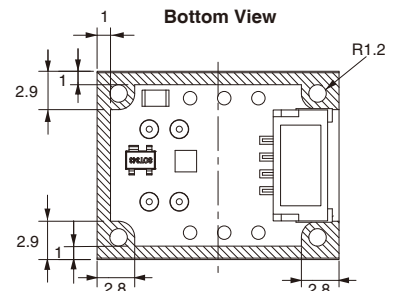
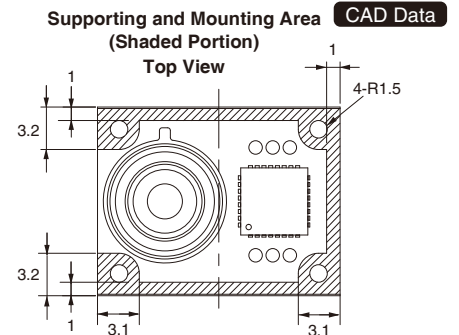
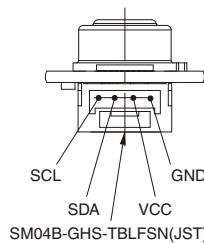
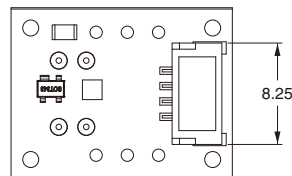
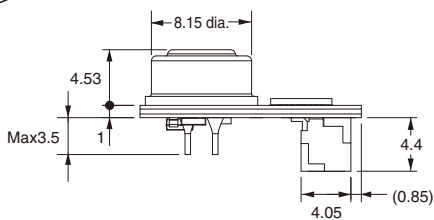
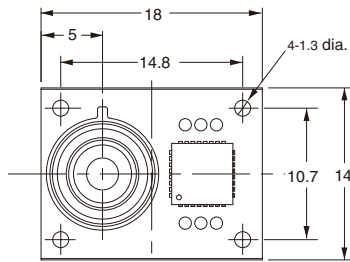
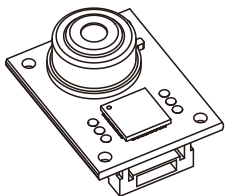

Note: Due to insulation distance limitations, do not allow metal parts to come into contact with the Sensor.

D6T-HARNESS-02 (Optional - sold separately)

Cable Color

- GND → BLACK Wire
- VCC → RED Wire
- SDA → BLUE Wire
- SCL → YELLOW Wire

* Length of Cable removed sheath.

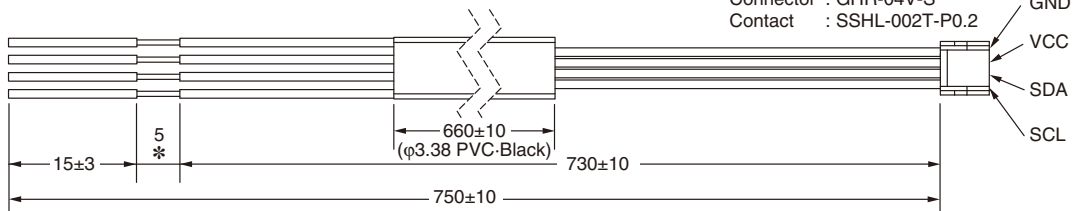

- Cable :UL1061.AWG#28
- UL Tube : T-105-2 No.8
- Connector : GHR-04V-S
- Contact : SSSL-002T-P0.2

CAD Data

Note: Unless otherwise specified, a tolerance of ±0.3 mm applies to all dimensions.

D6T

Safety Precautions

Precautions for Correct Use

● Installation

- The sensor may not achieve the characteristics given in this datasheet due to the ambient environment or installation location. Before using the Sensor, please acquire an adequate understanding and make a prior assessment of Sensor characteristics in your actual system.

● Operating Environment

- Do not use the Sensor in locations where dust, dirt, oil, and other foreign matter will adhere to the lens. This may prevent correct temperature measurements.
- Do not use the Sensor in any of the following locations.
 - Locations where the Sensor may come into contact with water or oil
 - Outdoors
 - Locations subject to direct sunlight.
 - Locations subject to corrosive gases (in particular, chloride, sulfide, or ammonia gases).
 - Locations subject to extreme temperature changes
 - Locations subject to icing or condensation.
 - Locations subject to excessive vibration or shock.

● Noise Countermeasures

- The Sensor does not contain any protective circuits. Never subject it to an electrical load that exceeds the absolute maximum ratings for even an instance. The circuits may be damaged. Install protective circuits as required so that the absolute maximum ratings are not exceeded.
- Keep as much space as possible between the Sensor and devices that generates high frequencies (such as high-frequency welders and high-frequency sewing machines) or surges.
- Attach a surge protector or noise filter on nearby noise-generating devices (in particular, motors, transformers, solenoids, magnetic coils, or devices that have an inductance component).
- In order to prevent inductive noise, separate the connector of the Sensor from power lines carrying high voltages or large currents. Using a shielded line is also effective.
- If a switching regulator is used, check that malfunctions will not occur due to switching noise from the power supply.

● Handling

- This Sensor is a precision device. Do not drop it or subject it to excessive shock or force. Doing so may damage the Sensor or change its characteristics. Never subject the connector to unnecessary force. Do not use a Sensor that has been dropped.
- Take countermeasures against static electricity before you handle the Sensor.
- Turn OFF the power supply to the system before you install the Sensor. Working with the Sensor while the power supply is turned ON may cause malfunctions.
- Secure the Sensor firmly so that the optical axis does not move.
- Install the Sensor on a flat surface. If the installation surface is not even, the Sensor may be deformed, preventing correct measurements.
- Do not install the Sensor with screws. Screws may cause the resist to peel from the board. Secure the Sensor in a way that will not cause the resist to peel.
- Always check operation after you install the Sensor.
- Use the specified connector (GHR-04 from JST) and connect it securely so that it will not come off. If you solder directly to the connector terminals, the Sensor may be damaged.
- Make sure to wire the polarity of the terminals correctly. Incorrect polarity may damage the Sensor.
- Never attempt to disassemble the Sensor.
- Do not use the cable harness to the other product.

Information of Related Products

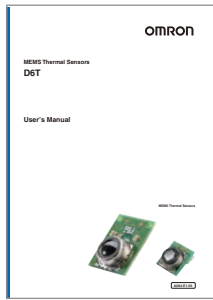

D6T MEMS Thermal Sensor User's Manual

Catalog No.
A284-E1

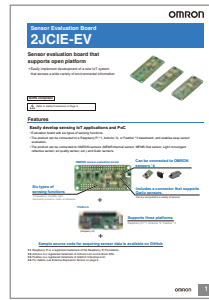

2JCIE-EV Sensor Evaluation Board

Catalog No.
A297-E1



D6F MEMS Flow Sensor

Catalog No.
X211-E1



Sensor Selection Guide

Catalog No.
Y232-E1

Please check each region's Terms & Conditions by region website.

OMRON Corporation Electronic and Mechanical Components Company

Regional Contact

Americas

<https://components.omron.com/>

Asia-Pacific

<https://ecb.omron.com.sg/>

Korea

<https://www.omron-ecb.co.kr/>

Europe

<http://components.omron.eu/>

China

<https://www.ecb.omron.com.cn/>

Japan

<https://www.omron.co.jp/ecb/>

OUR CERTIFICATE

DiGi provide top-quality products and perfect service for customer worldwide through standardization, technological innovation and continuous improvement. DiGi through third-party certification, we stricly control the quality of products and services. Welcome your RFQ to

Email: Info@DiGi-Electronics.com



Tel: +00 852-30501935

RFQ Email: Info@DiGi-Electronics.com

DiGi is a global authorized distributor of electronic components.