

# G3VM-WFL Datasheet



[www.digi-electronics.com](http://www.digi-electronics.com)

<https://www.DiGi-Electronics.com>

DiGi Electronics Part Number	G3VM-WFL-DG
Manufacturer	<a href="#">Omron Electronics Inc-EMC Div</a>
Manufacturer Product Number	G3VM-WFL
Description	SSR RELAY SPST-NO 120MA 0-350V
Detailed Description	Solid State SPST-NO (1 Form A) x 2 8-SMD (0.300", 7.62mm)

This model G3VM-WFL is available at DiGi Electronics.

DiGi Electronics offers a global database of semiconductor and electronic component datasheets.

We welcome your inquiries regarding pricing, lead time, or other product-related questions.

 [Request a Quote](#)

 [Datasheet Search](#)



Tel: +00 852-30501935

RFQ Email: [Info@DiGi-Electronics.com](mailto:Info@DiGi-Electronics.com)

DiGi is a global authorized distributor of electronic components.

## Purchase and inquiry

Manufacturer Product Number:

G3VM-WFL

Series:

G3VM

Mounting Type:

Surface Mount

Output Type:

AC, DC

Voltage - Load:

0 V ~ 350 V

On-State Resistance (Max):

35 Ohms

Package / Case:

8-SMD (0.300", 7.62mm)

Base Product Number:

G3VM

Manufacturer:

Omron Electronics Inc-EMC Div

Product Status:

Active

Circuit:

SPST-NO (1 Form A) x 2

Voltage - Input:

1.15VDC

Load Current:

120 mA

Termination Style:

Gull Wing

Supplier Device Package:

8-SMD

## Environmental & Export classification

RoHS Status:

ROHS3 Compliant

REACH Status:

REACH Unaffected

HTSUS:

8536.49.0055

Moisture Sensitivity Level (MSL):

1 (Unlimited)

ECCN:

EAR99

# G3VM-WL/WFL

## MOS FET Relays

### Current-limiting Models with 350-V Load Voltage. Including Models with 2 Outputs.

- Current limit 150 to 300 mA.

RoHS compliant

#### Application Examples

- Communication equipment
- Test & Measurement equipment

#### Terminal Arrangement/Internal Connections

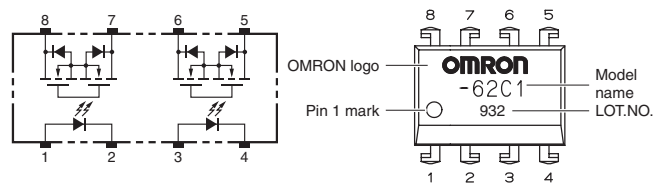

Note: Note: The actual product is marked differently from the image shown here.

Note: The actual product is marked differently from the image shown here.

#### List of Models

Package type	Contact form	Terminals	Load voltage (peak value) *	Model	Current limit	Minimum package quantity	
						Number per tube	Number per tape and reel
DIP8	2a (DPST-NO)	PCB Terminals	350 V	G3VM-WL	Available	50	-
		Surface-mounting Terminals		G3VM-WFL			
				G3VM-WFL (TR)			

\* The AC peak and DC value are given for the load voltage.

#### Absolute Maximum Ratings (Ta = 25°C)

Item	Symbol	Rating	Unit	Measurement conditions	
Input	LED forward current	IF	50	mA	
	Repetitive peak LED forward current	IFP	1	A	100 μs pulses, 100 pps
	LED forward current reduction rate	ΔIF/°C	-0.5	mA/°C	Ta ≥ 25°C
Output	LED reverse voltage	VR	6	V	
	Connection temperature	TJ	125	°C	
	Load voltage (AC peak/DC)	VOFF	350	V	
	Continuous load current (AC peak/DC)	Io	120	mA	
ON current reduction rate	ΔIo/°C	-1.2	mA/°C	Ta ≥ 25°C	
Connection temperature	TJ	125	°C		
Dielectric strength between I/O (See note 1.)	Vi-o	2500	Vrms	AC for 1 min	
Ambient operating temperature	Ta	-40 to +85	°C	With no icing or condensation	
Ambient storage temperature	Tstg	-55 to +125	°C	With no icing or condensation	
Soldering temperature	-	260	°C	10 s	

Note: 1. The dielectric strength between the input and output was checked by applying voltage between all pins as a group on the LED side and all pins as a group on the light-receiving side.

#### Electrical Characteristics (Ta = 25°C)

Item	Symbol	Minimum	Typical	Maximum	Unit	Measurement conditions	
Input	LED forward voltage	VF	1.0	1.15	1.3	V	IF = 10 mA
	Reverse current	IR	-	-	10	μA	VR = 6 V
	Capacity between terminals	CT	-	30	-	pF	V = 0, f = 1 MHz
Output	Trigger LED forward current	IFT	-	1	3	mA	Io = 120 mA
	Maximum resistance with output ON	RON	-	22	35	Ω	IF = 5 mA, Io = 120 mA
	Current leakage when the relay is open	ILEAK	-	-	1.0	μA	VOFF = 350 V
	Capacity between terminals	COFF	-	40	-	pF	V = 0, f = 1 MHz
Limit current	ILIM	150	-	300	mA	IF = 5 mA, VDD = 5 V, t = 5 ms	
Capacity between I/O terminals	CI-o	-	0.8	-	pF	f = 1 MHz, Vs = 0 V	
Insulation resistance between I/O terminals	RI-o	1000	-	-	MΩ	Vi-o = 500 VDC, RoH ≤ 60%	
Turn-ON time	tON	-	-	1.0	ms	IF = 5 mA, RL = 200 Ω, VDD = 20 V (See note 2.)	
Turn-OFF time	tOFF	-	-	1.0	ms		

Note: 2. Turn-ON and Turn-OFF Times

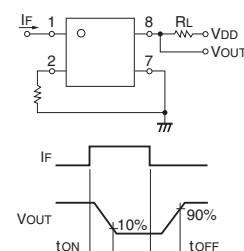

# G3VM-WL/WFL

## MOS FET Relays

### Recommended Operating Conditions

Use the G3VM under the following conditions so that the Relay will operate properly.

Item	Symbol	Minimum	Typical	Maximum	Unit
Load voltage (AC peak/DC)	V <sub>DD</sub>	-	-	280	V
Operating LED forward current	I <sub>F</sub>	5	7.5	25	mA
Continuous load current (AC peak/DC)	I <sub>o</sub>	-	-	100	mA
Ambient operating temperature	T <sub>a</sub>	-20	-	65	°C

### Engineering Data

LED forward current vs. Ambient temperature

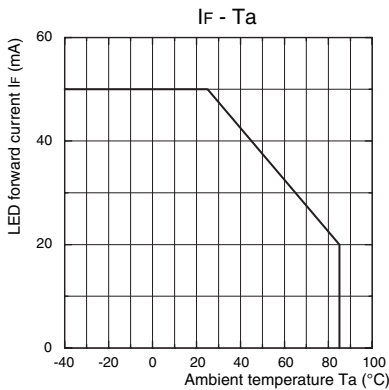

Continuous load current vs. Ambient temperature

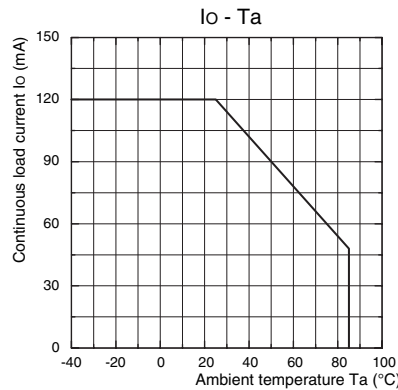

LED forward current vs. LED forward voltage

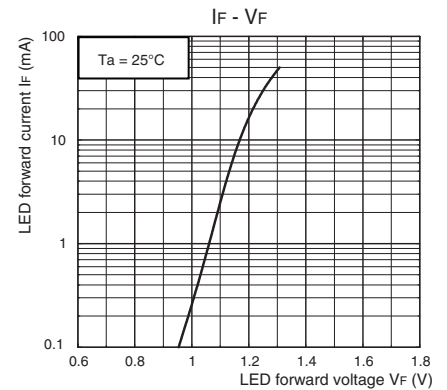

Continuous load current vs. On-state voltage

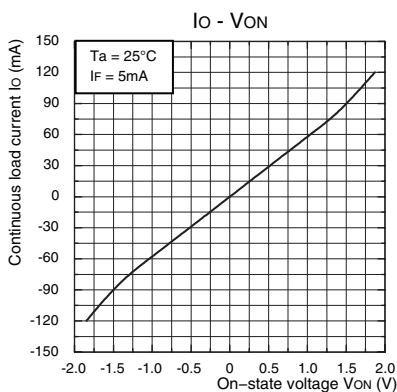

On-state resistance vs. Ambient temperature

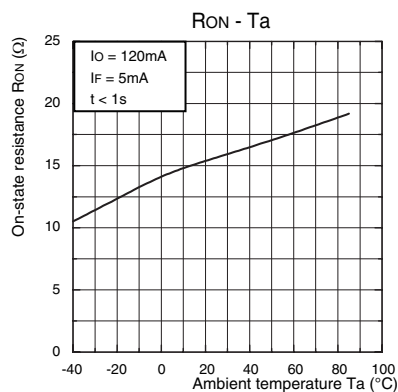

Trigger LED forward current vs. Ambient temperature

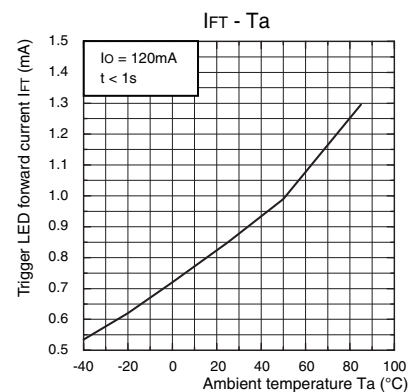

Turn ON, Turn OFF time vs. LED forward current

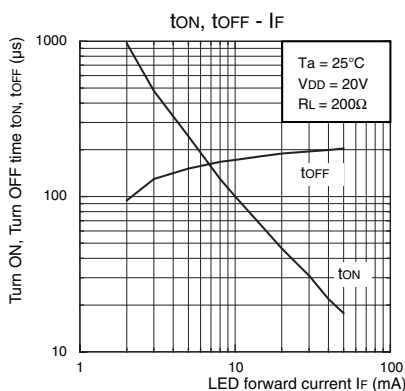

Turn ON, Turn OFF time vs. Ambient temperature

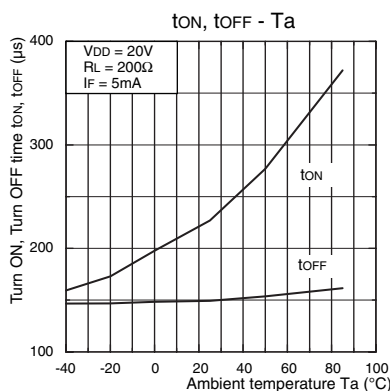

Current leakage vs. Ambient temperature

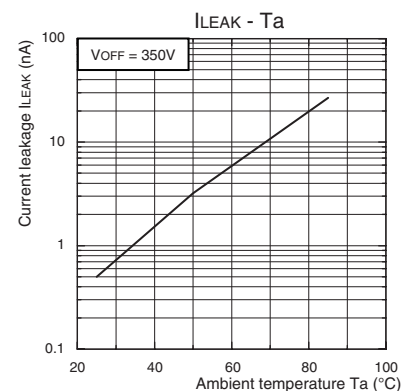

### Safety Precautions

- Refer to "Common Precautions" for all G3VM models.

# Appearance/Dimensions

## DIP8 type

### ■ Appearance

#### DIP (Dual Inline Package)

DIP8

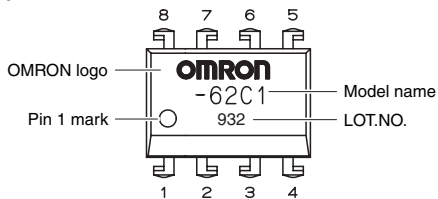

Note: The actual product is marked differently from the image shown here.

### ■ Dimensions

(Unit:mm)



#### PCB Terminals

Weight: 0.54 g

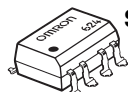
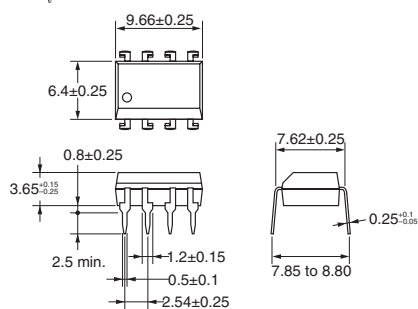

#### Surface-mounting Terminals

Weight: 0.54 g

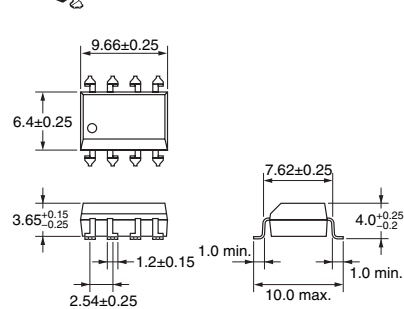

#### PCB Dimensions (BOTTOM VIEW)

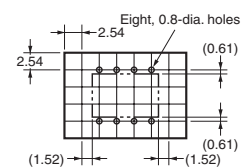

#### Actual Mounting Pad Dimensions

(Recommended Value, TOP VIEW)

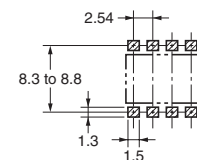

Note: The actual product is marked differently from the image shown here.

- Application examples provided in this document are for reference only. In actual applications, confirm equipment functions and safety before using the product.
- Consult your OMRON representative before using the product under conditions which are not described in the manual or applying the product to nuclear control systems, railroad systems, aviation systems, vehicles, combustion systems, medical equipment, amusement machines, safety equipment, and other systems or equipment that may have a serious influence on lives and property if used improperly. Make sure that the ratings and performance characteristics of the product provide a margin of safety for the system or equipment, and be sure to provide the system or equipment with double safety mechanisms.

Note: Do not use this document to operate the Unit.

## OMRON Corporation

ELECTRONIC AND MECHANICAL COMPONENTS COMPANY

Contact: [www.omron.com/ecb](http://www.omron.com/ecb)Cat. No. **K234-E1-01**  
0412(0412)(O)

