

<https://www.DiGi-Electronics.com>

G3VM-XNF Datasheet

DiGi Electronics Part Number	G3VM-XNF-DG
Manufacturer	Omron Electronics Inc-EMC Div
Manufacturer Product Number	G3VM-XNF
Description	SSR RELAY SPST-NO 300MA 0-60V

Detailed Description Solid State SPST-NO (1 Form A) 6-SMD (0.300", 7.62mm)
This model G3VM-XNF is available at DiGi Electronics.

DiGi Electronics offers a global database of semiconductor and electronic component datasheets. We welcome your inquiries regarding pricing, lead time, or other product-related questions.

 [Request a Quote](#)

 [Datasheet Search](#)

RFQ Email: Info@DiGi-Electronics.com

DiGi is a global authorized distributor of electronic components.

Purchase and inquiry

Manufacturer Product Number:

G3VM-XNF

Series:

G3VM

Mounting Type:

Surface Mount

Output Type:

AC, DC

Voltage - Load:

0 V ~ 60 V

On-State Resistance (Max):

2 Ohms

Package / Case:

6-SMD (0.300", 7.62mm)

Environmental & Export classification

Moisture Sensitivity Level (MSL):

1 (Unlimited)

Manufacturer:

Omron Electronics Inc-EMC Div

Product Status:

Obsolete

Circuit:

SPST-NO (1 Form A)

Voltage - Input:

1.4VDC

Load Current:

300 mA

Termination Style:

Gull Wing

Supplier Device Package:

6-SMD

ECCN:

OBSOLETE

MOS FET Relay General Catalog
G3VM Series

A wide range of contact forms and functions
Over 180 different models available

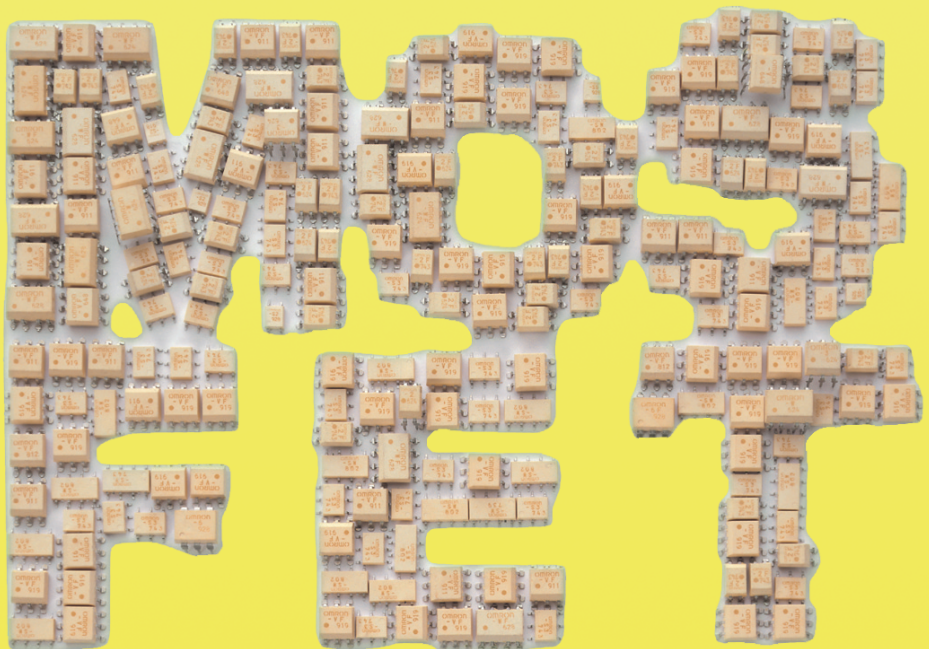

What's NEW !

The Very small package "S-VSON series" is now available
Expansion of the package "DIP/SOP" with High-current and Low-ON-resistance Type
Expansion of the Package "SOP" with General-purpose Type

2018

To the customer who buys Omron products

Warranty and Limited Warranty

(As of September, 2015. Please check Omron Corporation's homepage for the latest version of Terms and Conditions.)

Thank you for using Omron Corporation ("Omron") products. The Terms and Conditions hereunder are applied to *Omron products* regardless of where they are purchased. When you place an order, you are expected to agree to the Terms and Conditions described below.

1. Definition

The definition of terms used in these Terms and Conditions are as follows:

- (1) *Omron products*: FA system equipment, general-purpose control devices, sensors, and electronic/mechanism components under *Omron* brand
- (2) *Catalogues*: *Omron* general catalogue, FA system equipment general catalogue, safety component general catalogue, electronic/mechanism components general catalogue and other catalogues, specifications, instructions and manuals of *Omron products*, including electronically provided information available on the Omron electronic components information website, etc.
- (3) *Usage conditions*: Usage conditions, rating, performance, operating environment, handling instructions, cautions, prohibited use, etc. of *Omron products* described in catalogues.
- (4) *Customer application*: Application of *Omron products* by customers which include embedding and/or using *Omron products* in their parts/components, electronic substrates, devices, equipment or systems manufactured by customers.
- (5) *Fitness*: (a) fitness, (b) performance, (c) non-infringement of third-party intellectual property, (d) compliance with laws and regulations and (e) conformity to standards.

2. Caution on Descriptions

Attention is required to the following points on descriptions in catalogues.

- (1) Rated values and performance values are the product of tests performed for separate single conditions, including but not limited to temperature and humidity. It is not intended to warrant rated values and performance values for multiple combined conditions.
- (2) Reference data are provided for reference only. *Omron* does NOT warrant that *Omron products* work properly at all time in the range of reference data.
- (3) Application examples are provided for reference only. *Omron* does NOT warrant the fitness of *Omron products* under such application.
- (4) *Omron* may discontinue the production of *Omron products* or change the specifications of them for the purpose of improving such products or other reasons entirely at its own discretion.

3. Precautions

Please be aware of and accept the following when you introduce or use *Omron products*:

- (1) Please use *Omron products* in compliance with usage conditions including rating and performance.
- (2) Please confirm fitness of *Omron products* in your application and use your own judgment to determine the appropriateness of using them in such application. *Omron* shall not warrant the fitness of *Omron products* in customer application.
- (3) Please confirm that *Omron products* are properly wired and installed for their intended use in your overall system.
- (4) When using *Omron products*, please make sure to (i) maintain a margin of safety vis-à-vis the published rated and performance values, (ii) design to minimize risks to customer application in case of failure of *Omron products*, such as introducing redundancy, (iii) introduce system-wide safety measures to notify risks to users, and (iv) conduct regular maintenance on *Omron products* and customer application.
- (5) *Omron products* are designed and manufactured as general-purpose products for use in general industrial products. They are not intended to be used in the following applications. If you are using *Omron products* in the following applications, *Omron* shall not provide any warranty for such *Omron products*. Even in the case of the following applications to elevator/lift equipment and medical devices, etc, some case are likely applied to an usual guarantee prescribed on next article as general-purpose products used for general industrial products. So, please contact our sales person in charge.
 - (a) Applications with stringent safety requirements, including but not limited to nuclear power control equipment, combustion equipment, aerospace equipment, railway equipment, elevator/lift equipment, amusement park equipment, medical equipment, safety devices and other applications that could cause danger/harm to people's body and life.
 - (b) Applications that require high reliability, including but not limited to supply systems for gas, water and electricity, etc., 24 hour continuous operating systems, financial settlement systems and other applications that handle rights and property.
 - (c) Applications under severe conditions or in severe environment, including but not limited to outdoor equipment, equipment exposed to chemical contamination, equipment exposed to electromagnetic interference and equipment exposed to vibration and shocks.
 - (d) Applications under conditions and environment not described in catalogues.
- (6) In addition to the applications listed from (a) to (d) above, *Omron products* are not intended for use in automotive applications (including two wheel vehicles). Please do NOT use *Omron products* for automotive applications. Please contact *Omron* sales staff for products for automotive use.

4. Warranty Terms and Conditions

The terms and conditions for warranty of *Omron products* are as follows:

- (1) Warranty period: One year after the purchase from *Omron* or *Omron's* agency.
- (2) Coverage: *Omron* will provide either of the following two services for the malfunctioning *Omron products* at its own discretion:
 - (a) Free repair of malfunctioning *Omron products* at an *Omron* maintenance service location (Repair service is not available for electronic/mechanism parts.), or
 - (b) Free replacement of the malfunctioning *Omron products* with the same number of replacement/alternative products.
- (3) Exceptions: *Omron* will not cover *Omron products* under its warranty if the cause of the malfunction falls under any of the following:
 - (a) Usage in a manner other than the original intended use for the *Omron products*.
 - (b) Usage outside of the usage conditions.
 - (c) Modification or repair made to the *Omron products* by other than *Omron* personnel.
 - (d) Software program embedded by other than *Omron* or usage of such software.
 - (e) Causes which could not have been foreseen with the level of science and technology at the time of shipping from *Omron*.
 - (f) Causes originating from other than *Omron* or *Omron products* (including force majeure such as but not limited to natural disasters).

5. Limitation of Liability

The warranty set out in these Terms and Conditions is the whole and sole liability for *Omron products*. There are no other warranties, expressed or implied. *Omron* and the distributors of *Omron products* are not liable for any damages which may arise from or be related to *Omron products*.

6. Export Controls

Customers of *Omron products* shall comply with all applicable laws and regulations of Japan and/or other relevant countries with regard to security export control, when exporting *Omron products* and/or technical documents or providing such products and/or documents to a non-resident. *Omron* may not provide customers with *Omron products* and/or technical documents should they fail to comply with such laws and regulations.

(EC300E)

Overall Contents

MOS FET Relay General Catalog 2018

Introduction	
Overall Contents	3
Using this Catalog	4
Website	5
MOS FET Relays: G3VM Features	6
MOS FET Relay Application Examples	7
Features by Product Type	8
Product Index	10
Dimensions and Appearance Examples	13
Product Table	18
MOS FET Relay Glossary	52
Common Precautions for All MOS FET Relays	54

General-purpose Type	
DIP	
G3VM-□A□□□D□□□B□□□E□	62
SOP	
G3VM-6□G□□61VY□	68
G3VM-81G□	73
G3VM-201G□□/S5	77
G3VM-35□□G□□351VY/401G□	82
G3VM-□□H□	88

High-load-voltage Type	
SOP	
G3VM-601G□	94

Multi-contact-pair Type (2a, 2b, and 1a1b)	
DIP	
G3VM-□C□□□F□□□CR□□FR	98
SOP	
G3VM-□□J□	104

High-current and Low-ON-resistance Type	
DIP	
G3VM-□AR□□DR	110
G3VM-□BR□□□ER□	115
G3VM-□CR□□□FR□	121
SOP	
G3VM-41GR8/61GR□□/61VR	127
G3VM-21HR/31HR/41HR/61HR/61HR1	131
G3VM-81HR/101HR/101HR1	137
S-VSON	
G3VM-31QR/61QR2/101QR1	143

Small and High-dielectric-strength Type	
DIP	
G3VM-□AY□□□DY□	147

High-dielectric-strength Type	
DIP	
G3VM-□BY□□EY	155

Current-limiting Type	
DIP/SOP	
G3VM-□□L□□FL□□GL	159

Low-output-capacitance and Low-ON-resistance Type (with Low C × R)	
SOP	
G3VM-21GR□□/41GR4/41GR5/41GR6/81GR□	165
SSOP	
G3VM-21LR□	170
G3VM-41LR□	175
USOP	
G3VM-21PR□	180
G3VM-41PR□□/51PR	185
VSON	
G3VM-21UR□	190
G3VM-41UR□□/51UR	195
S-VSON	
G3VM-41QR10/61QR	200

Small and High-load-voltage Type	
SSOP	
G3VM-61LR/81LR/101LR	204
USOP	
G3VM-61PR□□/71PR/81PR/101PR	208
VSON	
G3VM-61UR□□/81UR□□/101UR	213

Models with Standards Certification	
Models with Standards Certification	218

Using this Catalog

There are the following three ways to search for products in this catalog.

1 Searching by Application

Recommended products are listed by typical industries and applications, such as security or communications, or by typical functions. You can select products based on applications or functions.

P.7

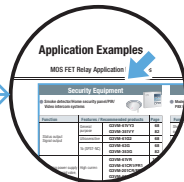

2 Searching by Product Feature

Products are classified by features, such as general purpose or small with high dielectric strength. You can select products for each application based on product features.

P.8

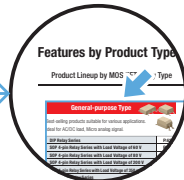

3 Searching by Product Model Number

The products are listed in a product index. You can select products by model number while checking specifications, such as the rated voltage or continuous load current.

P.10

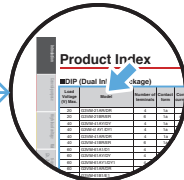

Improved Features of the MOS FET Relay General Catalog

Similar models are grouped together so that you can select models while comparing detailed performances.

Examples

● Continuous load current vs. Ambient temperature

G3VM-21BR/21ER/41BR/41ER

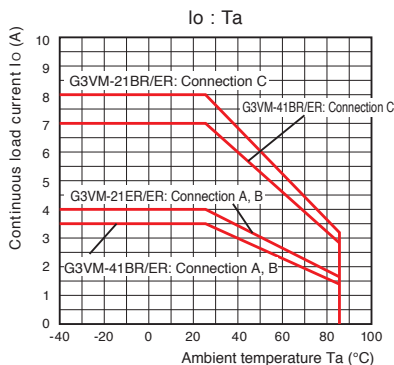

● Trigger LED forward current vs. Ambient temperature

G3VM-61UR/61UR1/81UR/81UR1/101UR

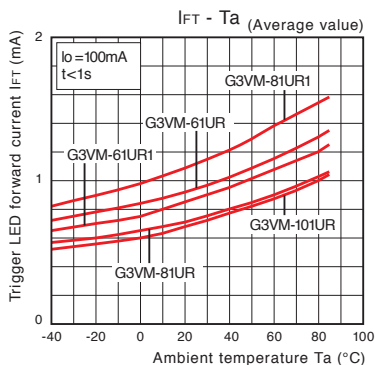



OMRON Electronic Components Web **OMRON E-WEB**

This website is dedicated to OMRON electronic components.

You can search for products based on model numbers, specifications, or product category.

The convenient interface also lets you view new product information and all of our services.

Note: The contents of this website are subject to change.

MOS FET Relay Select from Product Table

Please select MOSFET relay by checking the necessary items.

MOS FET Relays

Download Catalogues Check Product

Model	Shape	Package	Number of terminals	Terminals	Contact Form	Load Voltage (AC Peak/DC) (V)	Continuous Load Current (AC Peak /DC) (mA)	Typical Resistance with Output ON (Ω)	Dielectric Strength Between Input and Output(V)
Total Type:178 Matching Type:178	<input type="checkbox"/> DIP <input type="checkbox"/> SOP <input type="checkbox"/> SSOP <input type="checkbox"/> S-VSON	<input type="checkbox"/> 4 <input type="checkbox"/> 6 <input type="checkbox"/> 8 <input type="checkbox"/> 9	<input type="checkbox"/> O <input type="checkbox"/> PCB <input type="checkbox"/> Surface-mounting	<input type="checkbox"/> DPST-NC <input type="checkbox"/> DPST-NO <input type="checkbox"/> SPST-NC <input type="checkbox"/> SPST-NO	<input type="checkbox"/> 600 <input type="checkbox"/> 20	<input type="checkbox"/> 5000 <input type="checkbox"/> 40	<input type="checkbox"/> 45 <input type="checkbox"/> 0.02	<input type="checkbox"/> 500 <input type="checkbox"/> 1500 <input type="checkbox"/> 2500 <input type="checkbox"/> 3750	

Introduction
General-purpose
High-voltage
Multi-contact pair (2a, 2b and 1a/d)
High-current and Low-ON-resistance
Small and high-dielectric-strength
High-dielectric-strength
Current-limiting
Low-voltage-capacitance and Low-ON-resistance
Small and High-voltage
Certified Models with Standards Certification
DIP
SOP
SSOP
USOP
VSON
Website

MOS FET Relays: G3VM Features

G3VM Relays will help you downsize and reduce the energy consumption of a wide range of equipment.

Ultra Small Size and Weight

In addition to the SSOP and USOP, we have introduced the ultra-compact VSON and S-VSON packages, contributing to downsizing of equipment.

Low driving current

Realizing energy saving with standard driving current of 2 to 15mA. Ultrasensitive models are also available featuring Drive Currents as low as 0.2 mA (max).

Long operating life

MOS FET Relays use light signal instead of moveable contacts; avoiding reduction of life caused by contact wear, substantially increasing operational life.

Small leakage current

Can withstand external surge current without addition of snubber circuit. Under normal conditions, the typical leakage current is about 1 nA or below.

Excellent shock resistance

All the internal parts use casting method, and there is no movable parts in it, so it has excellent shock and vibration resistance.

High Insulation

MOS FET relays offer great I/O isolation due to its operational principle. It turns the voltage into the light and transfers by the light signal; Therefore input and output are isolated. The standard models offer 2,500 Vrms between input and output. Superior 5,000 VAC products are also available. 3,750 VAC products have also been added to the SOP package series.

Silent operation

As MOS FET Relays do not have mechanical contacts, by using a MOS FET instead of an electromechanical relay, it is possible to eliminate switching noise in your applications.

High-speed switching

Comparing with the switching time of 3 to 5 ms of a mechanical relay, its switching time is shortened to 0.2 ms(SSOP, USOP, VSON). Achieving quick response performance.

Control the micro analog signal correctly

Comparing with the triac, MOS FET greatly reduces the dead zone. The input waveform of micro analog signal does not suffer distortion as it does with a triac and is basically converted into output waveform without distortion.



Structure and operational principle of MOS FET relays

[Internal structure]

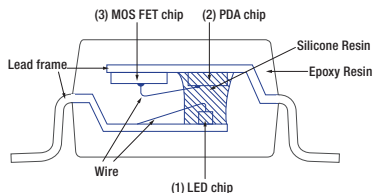

MOS FET relay consists of the following three components:
 (1) LED (light emitting diode)
 (2) Photodiode dome array (PDA)
 (3) MOS FET

[Operational Principle]

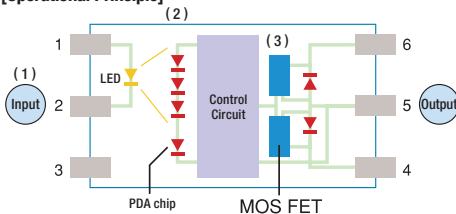

(1) The LED lights up when the current is connected at the input side.
 (2) The light sent by the LED will be converted into voltage when it is received by the Photodiode dome array.
 (3) This voltage will be the gate voltage to drive the MOS FET via control circuit.

Application Examples

MOS FET Relay Application Examples

Security Equipment

- Smoke detector/Home security panel/PIR/ Video intercom systems



Function	Features / Recommended products		Page
Status output Signal output	General purpose	G3VM-61VY3 G3VM-351VY	68 82
	Ultrasensitive	G3VM-61G2	68
	1b (SPST-NC)	G3VM-63G G3VM-353G	68 82
Switching power supply of small solenoid valve, small light External output	High current	G3VM-61VR	127
		G3VM-61CR1/FR1 G3VM-201CR/FR G3VM-601CR/FR	121 121 121
		G3VM-61AY1/DY1 G3VM-351AY1/DY1	147

FA/Industrial Equipment

- Machine tool/Customized power supply/Factory automation (PLC/Thermostat/Timer)



Function	Features / Recommended products		Page
Status output Signal output	General purpose	G3VM-61VY3	68
		G3VM-61A1/D1	62
		G3VM-351VY	82
		G3VM-351A/D	82
Switching power supply of small solenoid valve, small motor External output	High current	G3VM-61VR	127
		G3VM-61CR1/FR1 G3VM-201CR/FR G3VM-601CR/FR	121 121 121
		G3VM-61AY1/DY1 G3VM-351AY1/DY1	147
		High dielectric strength	G3VM-61AY1/DY1 G3VM-351AY1/DY1

Test & Measurement Equipment

- Semi-conductor test equipment (ATE)/
Semi-conductor test equipment interface board/
Tester for cars/PXI module/Data logger/ I/O board



Function	Features / Recommended products		Page
Switching test signal	Low C × R	G3VM-21UR1/UR10/UR11	190
		G3VM-41UR10/UR11/UR12	195
		G3VM-41QR10	200
		G3VM-51UR	195
		G3VM-61QR	200
	Small and High-load-voltage	G3VM-61UR1	213
High current	G3VM-31QR	143	
Switching power supply	High current	G3VM-31QR G3VM-61QR2 G3VM-101QR1	143

Communication Equipment

- Modems, Fax machines, network devices, and PBX transfer devices



Function	Features / Recommended products		Page
Short-circuit line switching	General purpose	G3VM-61VY3	68
		G3VM-351VY	82
Line switching	1b (SPST-NC)	G3VM-63G	68
		G3VM-353G	82

Energy-related Equipment

- BMS's (business management systems), power meters, smart meters, secondary power supplies, and photovoltaic systems



Function	Features / Recommended products		Page
External communications Charge voltage monitoring	High dielectric strength	G3VM-61AY1/DY1 G3VM-351AY1/DY1 G3VM-601AY1/DY1	147
		General purpose	G3VM-61VY3 G3VM-351VY
Storage battery charging	High current	G3VM-61CR1/FR1	121

Amusement Equipment

- Currency Sensing Modules
Coin dispenser / Information system



Function	Features / Recommended products		Page
Status output Signal output	General purpose	G3VM-61VY3	68
		G3VM-351VY	82
	1b (SPST-NC)	G3VM-63G G3VM-353G	68 82

Medical Equipment

Office automation/AV Equipment

Broadcasting Equipment

There are many other usages beyond the above applications.

Features by Product Type

Product Lineup by MOS FET Relay Type

General-purpose Type

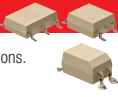

Best-selling products suitable for various applications. Ideal for AC/DC load, Micro analog signal.

DIP Relay Series	P.62
SOP 4-pin Relay Series with Load Voltage of 60 V	P.68
SOP 4-pin Relay Series with Load Voltage of 80 V	P.73
SOP 4-pin Relay Series with Load Voltage of 200 V	P.77
SOP 4-pin Relay Series with Load Voltage of 350 and 400 V	P.82
SOP 6-pin Relay Series	P.88

High-load-voltage Type

These MOS FET Relays come in SOP 4-pin packages and are for high load voltages.



Relay Series with Load Voltage of 600 V	P.94
---	------

Multi-contact-pair Type (2a, 2b, and 1a1b)

These MOS FET Relays provide multiple contact pairs (2a (DPST-NO), 2b (DPST-NC), and 1a1b (SPST-NO/SPST-NC)) for a wide range of circuits.



DIP 8-pin Relay Series	P.98
SOP 8-pin Relay Series	P.104

High-current and Low-ON-resistance Type

These MOS FET Relays achieve the low ON resistance and high switching capacity of a mechanical relay.



DIP 4-pin Relay Series	P.110
DIP 6-pin Relay Series	P.115
DIP 8-pin Relay Series	P.121
SOP 4-pin Relay Series	P.127
SOP 6-pin Relay Series	P.131
S-VSON Relay Series (New small package)	P.143

Small and High-dielectric-strength Type

Dielectric Strength between I/O 5,000 Vrms with small DIP4.

Models with high sensitivity are also available.



DIP 4-pin Relay Series	P.147
------------------------	-------

High-dielectric-strength Type

These MOS FET Relays come in DIP 6-pin packages and achieve a dielectric strength of 5,000 VAC between I/O.



Relay Series with Load Voltage of 400/600 V	P.155
---	-------

Current-limiting Type

These MOS FET Relays protect themselves from overcurrents with a current-limiting protection function.

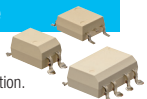

Relay Series with Load Voltage of 350 V	P.159
---	-------

Low-output-capacitance and Low-ON-resistance Type (with Low C × R)

Ideal for semi-conductor test equipment.

Low C (capacitance between terminals) × R (output on-resistance) type.



Models are also available that give priority to a low C or a low R.

SOP 4-pin Relay Series	P.165
SSOP Relay Series with Load Voltage of 20 V	P.170
SSOP Relay Series with Load Voltage of 40 V	P.175
USOP Relay Series with Load Voltage of 20 V	P.180
USOP Relay Series with Load Voltage of 40, 50 V	P.185
VSON Relay Series with Load Voltage of 20 V	P.190
VSON Relay Series with Load Voltage of 50 V	P.195
S-VSON Relay Series (New small package)	P.200

Small and High-load-voltage Type

These ultra-compact MOS FET Relays are for high load voltages.



SSOP Relay Series with Load Voltage of 60, 80, and 100 V	P.204
USOP Relay Series with Load Voltage of 60, 75, 80, and 100 V	P.208
VSON Relay Series with Load Voltage of 60, 80, 100V	P.213

Product Map by features

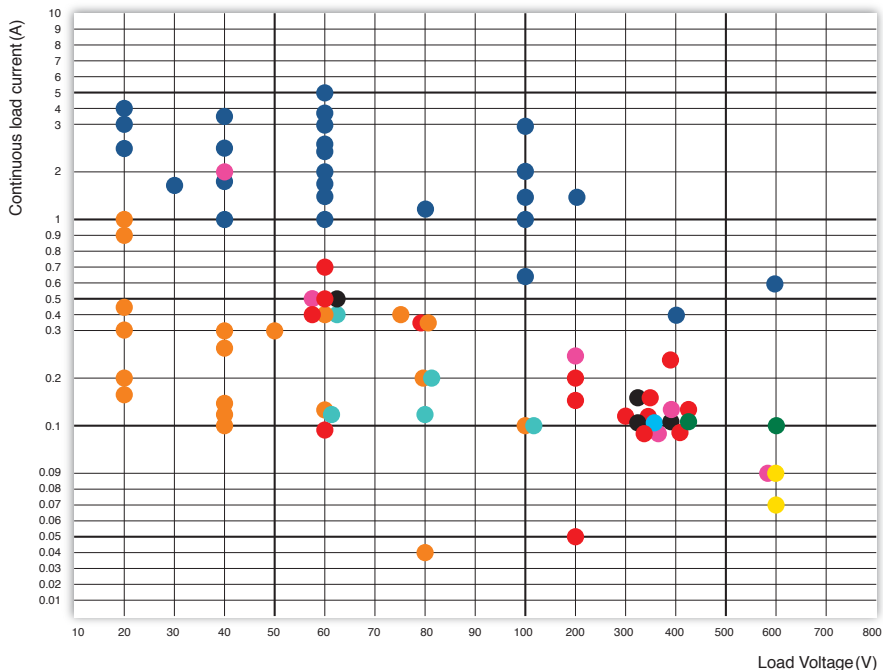

- General-purpose Type
- High-load-voltage Type
- Multi-contact-pair Type (2a, 2b, and 1a1b)
- High-current and Low-ON-resistance Type
- Small and High-dielectric-strength Type
- High-dielectric-strength Type
- Current-limiting Type
- Low-output-capacitance and Low-ON-resistance Type (with Low $C \times R$)
- Small and High-load-voltage Type

Product Index

■DIP (Dual Inline Package)

Load Voltage (V) Max.	Model	Number of terminals	Contact form	Continuous load current (mA) Max.	Maximum resistance with output ON (Ohm) Typ.	Current leakage when the relay is open (nA) Max.	Capacitance between terminals (pF) Typ.	Turn-ON time (ms) Max.	Turn-OFF time (ms) Max.	Dielectric strength between I/O (Vrms)	Page
20	G3VM-21AR/DR	4	1a	3000	0.04	1000	300	5	1	2500	110
20	G3VM-21BR/ER	6	1a	4000 (8000) *1	0.02	1000	1000	5	1	2500	115
40	G3VM-41AY/DY	4	1a	2000	0.09	1000	300	5	1	5000	147
40	G3VM-41AY1/DY1	4	1a	2000	0.09	1000	300	5	1	5000	147
40	G3VM-41AR/DR	4	1a	2500	0.05	1000	300	5	1	2500	110
40	G3VM-41BR/ER	6	1a	3500 (7000) *1	0.03	1000	1000	5	1	2500	115
60	G3VM-61A1/D1	4	1a	500	1	1000	130	2	0.5	2500	62
60	G3VM-61AY/DY	4	1a	500	0.6	1000	130	1	1	5000	147
60	G3VM-61AY1/DY1	4	1a	500	0.6	1000	130	3	1	5000	147
60	G3VM-61AR/DR	4	1a	2000	0.08	1000	250	5	1	2500	110
60	G3VM-61B1/E1	6	1a	500 (1000) *1	1	1000	130	2	0.5	2500	62
60	G3VM-61BR/ER	6	1a	2500	0.065	10	400	1.5	0.4	2500	115
60	G3VM-61BR1/ER1	6	1a	3000 (6000) *1	0.04	1000	1000	5	1	2500	115
60	G3VM-61CR1/FR1 <i>NEW</i>	8	1a	5000(10000) *1	0.022	10000	850	5	1	2500	121
60	G3VM-62C1/F1	8	2a	500	1	1000	130	2	0.5	2500	98
100	G3VM-101AR/DR	4	1a	1000	0.25	1000	200	5	1	2500	110
100	G3VM-101BR/ER	6	1a	2000 (4000) *1	0.1	1000	1000	5	1	2500	115
100	G3VM-101CR/FR <i>NEW</i>	8	1a	3000(6000)*1	0.06	1000	720	5	1	2500	121
200	G3VM-201AY/DY	4	1a	250	5	1000	90	1	1	5000	147
200	G3VM-201AY1/DY1	4	1a	250	5	1000	90	3	1	5000	147
200	G3VM-201CR/FR <i>NEW</i>	8	1a	1500(3000)*1	0.25	1000	400	5	1	2500	121
350	G3VM-351AY/DY	4	1a	100	35	1000	30	1	1	5000	147
350	G3VM-351AY1/DY1	4	1a	100	35	1000	30	2	1	5000	147
350	G3VM-2L2FL	4	1a	120 *2	22	1000	40	1	1	2500	159
350	G3VM-351A/D	4	1a	120	35	1000	30	1	1	2500	62
350	G3VM-353A/D	4	1b	150	15	1000	85	1	3	2500	62
350	G3VM-351B/E	6	1a	120 (240) *1	35	1000	30	1	1	2500	62
350	G3VM-353B/E	6	1b	150 (300) *1	15	1000	85	1	3	2500	62
350	G3VM-355CR/FR	8	1a1b	120	15	1000	65	1	3	2500	98
350	G3VM-352C/F	8	2a	120	35	1000	30	1	1	2500	98
350	G3VM-WL/WFL	8	2a	120 *2	22	1000	40	1	1	2500	159
350	G3VM-354C/F	8	2b	150	15	1000	85	1	3	2500	98
400	G3VM-401A/D	4	1a	120	18	1000	40	1	1	2500	62
400	G3VM-401AY/DY	4	1a	120	22	1000	80	1	1	5000	147
400	G3VM-401AY1/DY1	4	1a	120	22	1000	80	2	1	5000	147
400	G3VM-401B/E	6	1a	120 (240) *1	17	1000	40	1	1	2500	62
400	G3VM-401BY/EY	6	1a	120 (240) *1	17	1000	40	1	1	5000	155
400	G3VM-401CR/FR <i>NEW</i>	8	1a	400(800)*1	3	1000	410	1	1	2500	121
400	G3VM-402C/F	8	2a	120	18	1000	40	1	1	2500	98
600	G3VM-601AY/DY	4	1a	90	45	1000	75	1	1	5000	147
600	G3VM-601AY1/DY1	4	1a	90	45	1000	75	2	1	5000	147
600	G3VM-601BY/EY	6	1a	100 (200) *1	30	1000	120	1.5	1	5000	155
600	G3VM-601CR/FR <i>NEW</i>	8	1a	600(1200)*1	1.3	10000	4300	3	1	2500	121

*1 Load current in case of connection C is shown in parentheses (DC load only) *2 Current-Limiting function (Limit current 150 mA Min. 300 mA Max.)

■SOP (Small Outline Package)

Load Voltage (V) Max.	Model	Number of terminals	Contact form	Continuous load current (mA) Max.	Maximum resistance with output ON (Ohm) Typ.	Current leakage when the relay is open (nA) Max.	Capacitance between terminals (pF) Typ.	Turn-ON time (ms) Max.	Turn-OFF time (ms) Max.	Dielectric strength between I/O (Vrms)	Page
20	G3VM-21GR	4	1a	160	5	1	1	0.5	0.5	1500	165
20	G3VM-21GR1	4	1a	300	1	1	5	0.5	0.5	1500	165
20	G3VM-21HR	6	1a	2500 (5000) *1	0.02	10	1000	5	1	1500	131
30	G3VM-31HR <i>NEW</i>	6	1a	4000(8000)*1	0.02	1000	1100	5	1	1500	131
40	G3VM-41GR6	4	1a	120	10	1	1	0.5	0.5	1500	165
40	G3VM-41GR4	4	1a	250	2	1	5	0.5	0.5	1500	165
40	G3VM-41GR5	4	1a	300	1	1	10	0.5	0.5	1500	165
40	G3VM-41GR8	4	1a	1000	0.1	1	300	3	0.5	1500	127
40	G3VM-41HR	6	1a	2500 (5000) *1	0.03	10	1000	5	1	1500	131
60	G3VM-61VY1	4	1a	100	25	1000	10	5	5	3750	68
60	G3VM-61G1	4	1a	400	1	1000	130	2	0.5	1500	68
60	G3VM-61G2	4	1a	400	1	1000	130	8	3	1500	68
60	G3VM-61G3	4	1a	400	1	1000	130	10	5	1500	68
60	G3VM-61VY2 <i>NEW</i>	4	1a	500	1	1000	20	2	0.5	3750	68
60	G3VM-61VY3 <i>NEW</i>	4	1a	700	0.15	1000	100	3	0.5	3750	68
60	G3VM-61GR1	4	1a	1000	0.25	100	90	3	1	1500	127
60	G3VM-61GR2 <i>NEW</i>	4	1a	1700	0.08	10	250	3	0.5	1500	127
60	G3VM-61VR <i>NEW</i>	4	1a	1400	0.13	1000	100	3	1	3750	127
60	G3VM-63G <i>NEW</i>	4	1b	500	1	1000	100	1	3	1500	68
60	G3VM-61H1	6	1a	400 (800) *1	1	1000	130	2	0.5	1500	88
60	G3VM-61HR	6	1a	2300 (4600) *1	0.04	10	1000	5	1	1500	131
60	G3VM-61HR1 <i>NEW</i>	6	1a	3300 (6600)*1	0.03	20	700	5	1	1500	131

*1 Load current in case of connection C is shown in parentheses (DC load only) *2 Current-Limiting function (Limit current 150 mA Min. 300 mA Max.)

Product Index

■SOP (Small Outline Package)

Load Voltage (V) Max.	Model	Number of terminals	Contact form	Continuous load current (mA) Max.	Maximum resistance with output ON (Ohm) Typ.	Current leakage when the relay is open (nA) Max.	Capacitance between terminals (pF) Typ.	Turn-ON time (ms) Max.	Turn-OFF time (ms) Max.	Dielectric strength between I/O (Vrms)	Page	
60	G3VM-62J1	8	2a	400	1	1000	130	2	0.5	1500	104	
80	G3VM-81GR	4	1a	40	16	1	2.5	0.5	0.5	1500	165	
80	G3VM-81GR1	4	1a	200	5	1	6.5	0.5	0.5	1500	165	
80	G3VM-81G1	4	1a	350	1	1	30	0.5	0.5	1500	73	
80	G3VM-81HR	6	1a	1250 (2500) *1	0.11	1.5	460	3	1	1500	137	
100	G3VM-101HR	6	1a	1400 (2800) *1	0.1	10	1000	5	1	1500	137	
100	G3VM-101HR1	<i>NEW</i>	6	1a	2000 (4000)*1	0.045	1000	5	1	1500	137	
200	G3VM-201G	4	1a	50	40	1	15	0.5	0.2	1500	77	
200	G3VM-201G1	4	1a	200	5	1000	90	8	3	1500	77	
200	G3VM-201G2	4	1a	200	5	1000	90	10	5	1500	77	
200	G3VM-S5	4	1a	200	5	1000	100	1.5	1	1500	77	
200	G3VM-201H1	6	1a	200 (400) *1	5	1000	100	1.5	1	1500	88	
200	G3VM-202J1	8	2a	200	5	1000	100	1.5	1	1500	104	
350	G3VM-351G1	4	1a	100	35	1000	35	5	3	1500	82	
350	G3VM-351G	4	1a	110	35	1000	30	1	1	1500	82	
350	G3VM-351VY	<i>NEW</i>	4	1a	110	35	1000	60	1	0.5	3750	82
350	G3VM-351QL	4	1a	120 *2	15	1000	70	1	1	1500	159	
350	G3VM-353G	4	1b	120	15	1000	65	1	3	1500	82	
350	G3VM-351H	6	1a	110 (220) *1	35	1000	30	1	1	1500	88	
350	G3VM-353H	6	1b	120 (240) *1	15	1000	65	1	3	1500	88	
350	G3VM-355JR	8	1a1b	120	15	1000	65	1	3	1500	104	
350	G3VM-352J	8	2a	110	35	1000	30	1	1	1500	104	
350	G3VM-354J	8	2b	120	15	1000	65	1	3	1500	104	
400	G3VM-401G1	4	1a	100	18	1000	70	10	5	1500	82	
400	G3VM-401G	4	1a	120	17	1000	70	1	1	1500	82	
400	G3VM-401H	6	1a	120 (240) *1	17	1000	70	1	1	1500	88	
400	G3VM-402J	8	2a	120	17	1000	70	1	1	1500	104	
600	G3VM-601G1	4	1a	70	35	1000	75	10	5	1500	94	
600	G3VM-601G	4	1a	90	45	1000	75	8	3	1500	94	

*1 Load current in case of connection C is shown in parentheses (DC load only)

*2 Current-Limiting function (Limit current 150 mA Min. 300 mA Max.)

■SSOP (Shrink Small Outline Package)

Load Voltage (V) Max.	Model	Number of terminals	Contact form	Continuous load current (mA) Max.	Maximum resistance with output ON (Ohm) Typ.	Current leakage when the relay is open (nA) Max.	Capacitance between terminals (pF) Typ.	Turn-ON time (ms) Max.	Turn-OFF time (ms) Max.	Dielectric strength between I/O (Vrms)	Page
20	G3VM-21LR	4	1a	160	5	1	1	0.5	0.5	1500	170
20	G3VM-21LR10	4	1a	200	3	0.2	0.8	0.2	0.2	1500	170
20	G3VM-21LR1	4	1a	450	0.8	1	5	0.5	0.5	1500	170
20	G3VM-21LR11	4	1a	900	0.18	1	40	2	1	1500	170
40	G3VM-41LR10	4	1a	120	12	0.2	0.45	0.2	0.3	1500	175
40	G3VM-41LR6	4	1a	120	10	1	1	0.5	0.5	1500	175
40	G3VM-41LR11	4	1a	140	7	0.2	0.7	0.2	0.2	1500	175
40	G3VM-41LR4	4	1a	250	2	1	5	0.5	0.5	1500	175
40	G3VM-41LR5	4	1a	300	1	1	10	0.5	0.5	1500	175
60	G3VM-61LR	4	1a	400	1	1000	20	1	1	1500	204
80	G3VM-81LR	4	1a	120	7.5	0.2	5	0.25	0.2	1500	204
100	G3VM-101LR	4	1a	80	8	0.2	6	0.3	0.3	1500	204

■USOP (Ultra Small Outline Package)

Load Voltage (V) Max.	Model	Number of terminals	Contact form	Continuous load current (mA) Max.	Maximum resistance with output ON (Ohm) Typ.	Current leakage when the relay is open (nA) Max.	Capacitance between terminals (pF) Typ.	Turn-ON time (ms) Max.	Turn-OFF time (ms) Max.	Dielectric strength between I/O (Vrms)	Page
20	G3VM-21PR10	4	1a	200	3	1	0.8	0.2	0.2	500	180
20	G3VM-21PR1	4	1a	450	0.6	1	5	0.5	0.5	500	180
20	G3VM-21PR11	4	1a	900	0.18	1	40	2	1	500	180
40	G3VM-41PR12	4	1a	100	15	1	0.3	0.2	0.2	500	185
40	G3VM-41PR6	4	1a	120	10	0.2	1	0.2	0.3	500	185
40	G3VM-41PR10	4	1a	120	12	1	0.45	0.2	0.3	500	185
40	G3VM-41PR11	4	1a	140	7	1	0.7	0.2	0.2	500	185
40	G3VM-41PR5	4	1a	300	1	1	10	0.5	0.3	500	185
50	G3VM-51PR	4	1a	300	1	1	12	0.5	0.4	500	185
60	G3VM-61PR1	4	1a	120	10	1	0.7	0.2	0.2	500	208
60	G3VM-61PR	4	1a	400	1	1	20	0.5	0.5	500	208
75	G3VM-71PR	4	1a	400	1	1	30	2	1	500	208
80	G3VM-81PR	4	1a	120	7	0.02	5	0.5	0.2	500	208
100	G3VM-101PR	4	1a	100	8	0.2	6	0.3	0.3	500	208

Product Index

■VSON (Very Small Outline Package Non-leaded)

Load Voltage (V) Max.	Model	Number of terminals	Contact form	Continuous load current (mA) Max.	Maximum resistance with output ON (Ohm) Typ.	Current leakage when the relay is open (nA) Max.	Capacitance between terminals (pF) Typ.	Turn-ON time (ms) Max.	Turn-OFF time (ms) Max.	Dielectric strength between I/O (Vrms)	Page
20	G3VM-21UR10	4	1a	200	3	1	0.8	0.2	0.2	500	190
20	G3VM-21UR1	4	1a	450	0.8	1	5	0.4	0.4	500	190
20	G3VM-21UR11	4	1a	1000	0.18	1	40	2	1	500	190
40	G3VM-41UR12	4	1a	100	15	1	0.3	0.2	0.2	500	195
40	G3VM-41UR10	4	1a	120	12	1	0.45	0.2	0.3	500	195
40	G3VM-41UR11	4	1a	140	7	1	0.7	0.2	0.2	500	195
50	G3VM-51UR	4	1a	300	1	1	12	0.5	0.4	500	195
60	G3VM-61UR1	4	1a	120	10	1	0.7	0.2	0.2	500	213
60	G3VM-61UR	4	1a	400	1	1	20	0.5	0.5	500	213
80	G3VM-81UR	4	1a	120	7	0.02	5	0.5	0.2	500	213
80	G3VM-81UR1	4	1a	200	6	1	6.5	0.4	0.4	500	213
100	G3VM-101UR	4	1a	100	8	0.2	6	0.3	0.3	500	213

■S-VSON (Super-Very Small Outline Package Non-leaded)

Load Voltage (V) Max.	Model	Number of terminals	Contact form	Continuous load current (mA) Max.	Maximum resistance with output ON (Ohm) Typ.	Current leakage when the relay is open (nA) Max.	Capacitance between terminals (pF) Typ.	Turn-ON time (ms) Max.	Turn-OFF time (ms) Max.	Dielectric strength between I/O (Vrms)	Page
30	G3VM-31QR	<i>NEW</i> 4	1a	1500	0.1	1	120	2	1	500	143
40	G3VM-41QR10	<i>NEW</i> 4	1a	120	11	1	0.45	0.2	0.3	500	200
60	G3VM-61QR	<i>NEW</i> 4	1a	400	1.1	1	12	0.5	0.3	500	200
60	G3VM-61QR2	<i>NEW</i> 4	1a	1000	0.2	1	80	2	0.3	500	143
100	G3VM-101QR1	<i>NEW</i> 4	1a	650	0.4	1	50	2	0.3	500	143

G3VM Model Number Legend

G3VM- □ □ □ □ □

(1)

(2)

(3)

(4)

(5)

(1) Load voltage

2: 20 V
3: 30 V
4: 40 V
5: 50 V
6: 60 V
7: 75V
8: 80 V
10: 100 V
20: 200 V
35: 350 V
40: 400 V
60: 600 V

(2) Contact form

1: 1a (SPST-NO)
2: 2a (DPST-NO)
3: 1b (SPST-NC)
4: 2b (DPST-NC)
5: 1a1b (SPST-NO/SPST-NC)

(3) Package

A: DIP 4-pin PCB Terminals
B: DIP 6-pin PCB Terminals
C: DIP 8-pin PCB Terminals
D: DIP 4-pin Surface-mounting Terminals
E: DIP 4-pin Surface-mounting Terminals
F: DIP 8-pin Surface-mounting Terminals
G: SOP 4-pin
H: SOP 6-pin
J: SOP 8-pin
L: SSOP 4-pin
P: USOP 4-pin
Q: S-VSON 4-pin
U: VSON 4-pin
V: Special SOP 4-pin

(4) Additional functions

L: Current limit
R: Low ON-resistance type
Y: Dielectric strength between I/O above 2.5 kV type

(5) Other information

When specifications overlap, serial code is added in the recorded order.

Note: 1. Some products may have a different model number structure.

Note: 2. In order to avoid the confusion of l (English letter) and 1 (number), l (English letter) is not used here.

Note: 3. For SOP 4-pin models, where the available marking space is insufficient to clearly differentiate model numbers with 6 or more suffix digits, the package type code (3) is omitted.

Dimensions and Appearance Examples

■DIP4

(Unit: mm)



PCB Terminals

Weight: 0.25 g

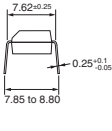
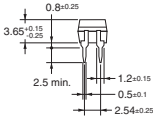
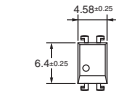

Surface-mounting Terminals

Weight: 0.25 g

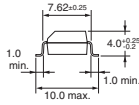

PCB Dimensions (BOTTOM VIEW)

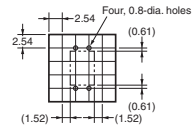

Actual Mounting Pad Dimensions (Recommended Value, Top View)

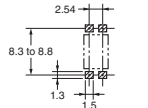

■DIP6

(Unit: mm)



PCB Terminals

Weight: 0.4 g

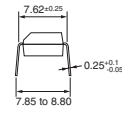
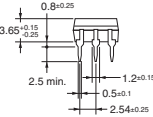
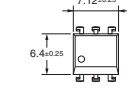

Surface-mounting Terminals

Weight: 0.4 g

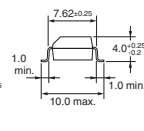
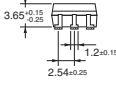
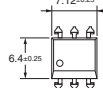

PCB Dimensions (BOTTOM VIEW)

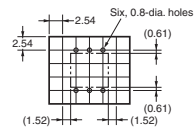

Actual Mounting Pad Dimensions (Recommended Value, Top View)

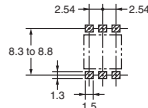

■Special DIP6 * (G3VM-61BR/ER)

(Unit: mm)



PCB Terminals

Weight: 0.4 g

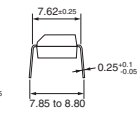
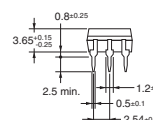
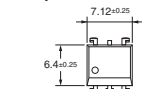

Surface-mounting Terminals

Weight: 0.4 g

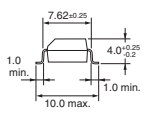
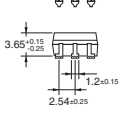
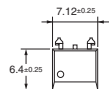

PCB Dimensions (BOTTOM VIEW)

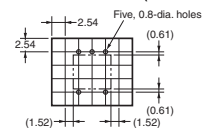

Actual Mounting Pad Dimensions (Recommended Value, Top View)

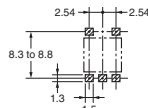

* The external dimensions of the standard DIP 6-pin are the same, but the number of terminals is different.

Note: The actual product is marked differently from the image shown here.

Dimensions and Appearance Examples

■DIP8

(Unit: mm)



PCB Terminals

Weight: 0.54 g

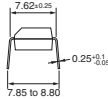
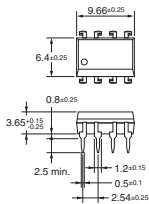

Surface-mounting Terminals

Weight: 0.54 g

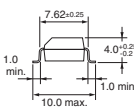
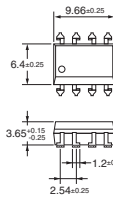

PCB Dimensions (BOTTOM VIEW)

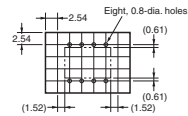

Actual Mounting Pad Dimensions

(Recommended Value, Top View)

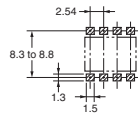

■SOP4

(Unit: mm)



Surface-mounting Terminals

Weight: 0.1 g

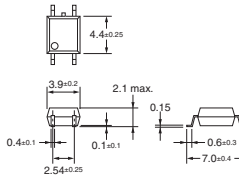

Actual Mounting Pad Dimensions

(Recommended Value, Top View)

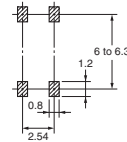

■Special SOP6 * (G3VM-61VY1)

(Unit: mm)



Surface-mounting Terminals

Weight: 0.1 g

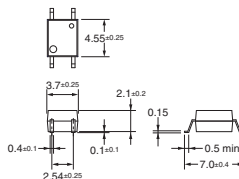

Actual Mounting Pad Dimensions

(Recommended Value, Top View)

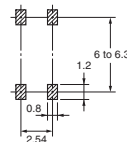

* The external dimensions are different from those of the standard SOP 4-pin, but the mounting pad dimensions are the same.

■SOP6

(Unit: mm)



Surface-mounting Terminals

Weight: 0.13 g

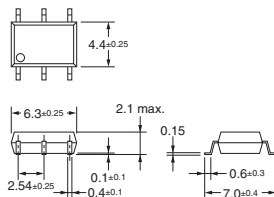

Actual Mounting Pad Dimensions

(Recommended Value, Top View)

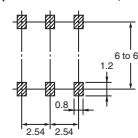

Note: The actual product is marked differently from the image shown here.

Dimensions and Appearance Examples

■SOP8

(Unit: mm)



Surface-mounting Terminals

Weight: 0.2 g

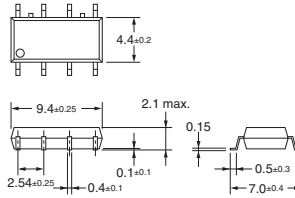

Actual Mounting Pad Dimensions

(Recommended Value, Top View)

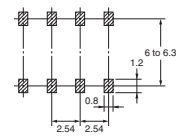

■SSOP4

(Unit: mm)



Surface-mounting Terminals

Weight: 0.03 g

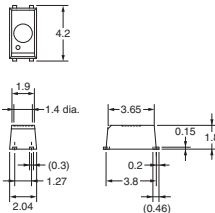
Unless otherwise specified, the dimensional tolerance is ± 0.1 mm.

Actual Mounting Pad Dimensions

(Recommended Value, Top View)

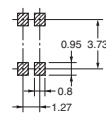

■USOP4

(Unit: mm)



Surface-mounting Terminals

Weight: 0.03 g

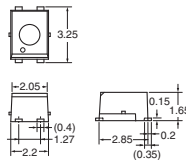
Unless otherwise specified, the dimensional tolerance is ± 0.2 mm.

Actual Mounting Pad Dimensions

(Recommended Value, Top View)

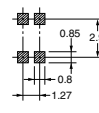

■VSON4

(Unit: mm)



Surface-mounting Terminals

Weight: 0.01 g

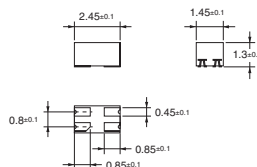

Actual Mounting Pad Dimensions

(Recommended Value, Top View)

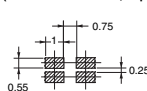

Note: The actual product is marked differently from the image shown here.

Dimensions and Appearance Examples

■S-VSON4

(Unit: mm)



Surface-mounting Terminals

Weight: 0.01 g

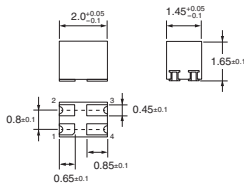

Actual Mounting Pad Dimensions

(Recommended Value, Top View)

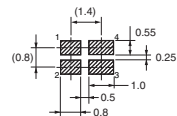
Unless otherwise specified, the dimensional tolerance is ± 0.1 mm.

■S-VSON(L)*4

(Unit: mm)



Surface-mounting Terminals

Weight: 0.01 g

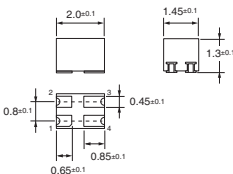

Actual Mounting Pad Dimensions

(Recommended Value, Top View)

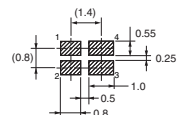
Unless otherwise specified, the dimensional tolerance is ± 0.1 mm.

* (L): Low profile type

Appearance Examples

DIP (Dual In-line Package)

DIP4

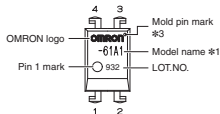

DIP6

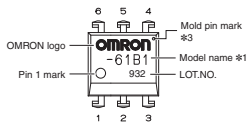

Special DIP6 #4

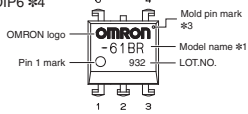

DIP8

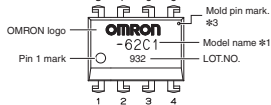

SOP (Small Outline Package)

SOP4

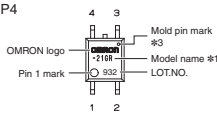

Special SOP4 #5

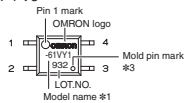

SOP6

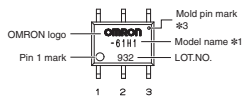

SOP8



SSOP (Shrink Small Outline Package)

SSOP4

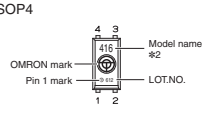

USOP (Ultra Small Outline Package)

USOP4

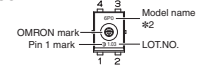

VSON (Very Small Outline Non-leaded)

VSON4

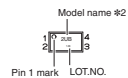

S-VSON (Super-Very Small Outline Non-leaded)

S-VSON4 pin / S-VSON(L)4 pin

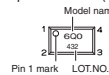

*1. "G3VM" does not appear in the model numbers on DIP or SOP Relays.

*2. Model numbers are on SSOP4, USOP4, and VSON4 Relays according to the Model Number Indication Standards.

*3. The indentation may appear in the corner diagonally opposite from the pin 1 mark due to extrusion by metal casting.

*4. The external dimensions of the standard DIP 6-pin are the same, but the number of terminals is different.

*5. The external dimensions are different from those of the standard SOP 4-pin, but the mounting pad dimensions are the same.

Dimensions and Appearance Examples

Model Number Indication Standards for SSOP4, USOP4 and VSON4 Relays

* Only three digits are given for the model number due to the small package size.

SSOP4

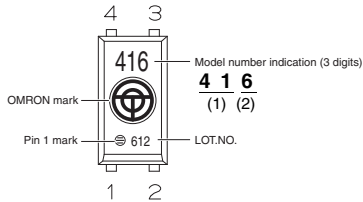

(1) Load voltage

21: 20 V
 41: 40 V
 51: 50 V
 61: 60 V
 81: 80 V
 10: 100 V

(2) Characters for Serial Numbers at the Ends of Model Numbers

0: Indicates no number at the end of the model number.

1 to 9: Indicate the given number.

Numbers 10 and higher indicate letters of the alphabet (A, B, C, etc.).

However, "101" is given for the G3VM-101LR

Examples

416: G3VM-41LR6
 21B: G3VM-21LR11

USOP4, VSON4, S-VSON4

USOP4

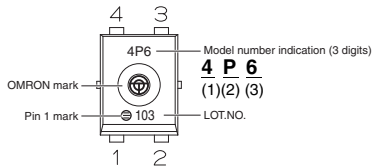

USOP4, VSON4, S-VSON4 Relay

(1) Load voltage

2: 20 V
 3: 30 V
 4: 40 V
 5: 50 V
 6: 60 V
 7: 75 V
 8: 80 V
 A: 100 V

(2) Package

P: USOP4
 U: VSON4
 Q: S-VSON4 4 pin
 S-VSON(L)* 4 pin
 * (L): Low profile type

(3) Characters for Serial Numbers at the Ends of Model Numbers

0: Indicates no number at the end of the model number.

1 to 9: Indicate the given number.

Numbers 10 and higher indicate letters of the alphabet (A, B, C, etc.).

Examples

4P6: G3VM-41PR6
 2UB: G3VM-21UR11

VSON4

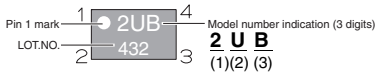

S-VSON 4/S-VSON(L) 4

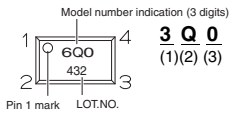

Product Table

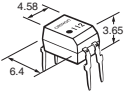
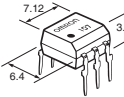
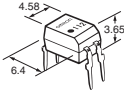
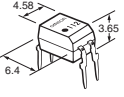
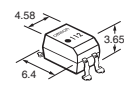
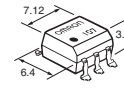
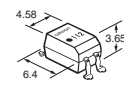
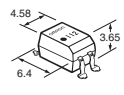
Application		For PCBs				
Model	G3VM-21AR G3VM-21DR	G3VM-21BR G3VM-21ER	G3VM-41AY G3VM-41DY	G3VM-41AY1 G3VM-41DY1		
Contact form	1a (SPST-NO)					
Package (Unit : mm, Average)						
						
Features	<ul style="list-style-type: none"> High-current and Low-ON-resistance Type Load voltage: 20 V Continuous load current : 3 A max. 	<ul style="list-style-type: none"> High-current and Low-ON-resistance Type Load voltage: 20 V Continuous load current: 4 A (8 A) max.* * Values in parentheses are for connection C. 	<ul style="list-style-type: none"> Small and High-dielectric-strength Type Load voltage: 40 V Dielectric strength between I/O: 5,000 VAC Trigger LED forward current : 2 mA max. 	<ul style="list-style-type: none"> Small and High-dielectric-strength Type Load voltage: 40 V Dielectric strength between I/O: 5,000 VAC 		
Isolation method		Photodiode coupler				
Absolute maximum ratings	Output	Load voltage	20 V		40 V	
		AC peak DC	20 V		40 V	
	Continuous load current AC peak/ DC * 6-pin type connection C: DC	10,000	-----		-----	
		9,000	-----		-----	
	8,000	-----		-----		
	7,000	-----		-----		
	6,000	-----		-----		
	5,000	-----		-----		
	4,000	-----		-----		
	3,000	3,000 mA	4,000 mA	-----		
2,000	-----		2,000 mA	2,000 mA		
1,000	-----		-----			
900	-----		-----			
800	-----		-----			
700	-----		-----			
600	-----		-----			
500	-----		-----			
400	-----		-----			
300	-----		-----			
200	-----		-----			
100	-----		-----			
Input	LED forward current	30 mA				
Dielectric strength between I/O		2,500 VAC 50/60 Hz for 1 min.		5,000 VAC 50/60 Hz for 1 min.		
Ambient operating temperature		-40 to +85°C (with no icing or condensation)				
Electrical characteristics	Output	Maximum output ON resistance	0.08 Ω		0.15 Ω	
		Maximum OFF leakage current	1 μA (at 20 VDC)		1 μA (at 40 VDC)	
Terminal structure	Surface-mounting terminals	●				
	PCB terminals	●				
Mounting method		PCB mounting or Surface mounting				
Applicable standards		UL				
RoHS compliance		Compliant				
Weight		0.25 g	0.4 g	0.25 g		
Page		110	115	147	147	

* Only basic specifications are given in this table. Refer to the reference page given in the table for detailed specifications and precautions before you attempt to use a Relay.
* Refer to pages 218 to 220 for detailed information on models certified for standards.

Product Table

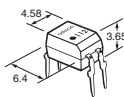
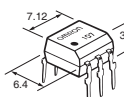
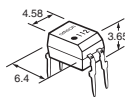
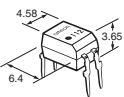
For PCBs				Application																							
G3VM-41AR G3VM-41DR	G3VM-41BR G3VM-41ER	G3VM-61A1 G3VM-61D1	G3VM-61AY G3VM-61DY	Model																							
1a (SPST-NO)				Contact form																							
				Package (Unit : mm, Average)																							
DIP4	DIP6	DIP4	DIP4																								
<ul style="list-style-type: none"> High-current and Low-ON-resistance Type Load voltage: 40 V Continuous load current : 2.5 A max. 	<ul style="list-style-type: none"> High-current and Low-ON-resistance Type Load voltage: 40 V Continuous load current: 3.5 A (7 A) max. * * Values in parentheses are for connection C. 	<ul style="list-style-type: none"> General-purpose Type Load voltage: 60 V 	<ul style="list-style-type: none"> Small and High-dielectric-strength Type Load voltage: 60 V Dielectric strength between I/O: 5,000 VAC Trigger LED forward current : 2 mA max. 	Features																							
Photodiode coupler				Isolation method																							
40 V		60 V		<table border="1"> <thead> <tr> <th rowspan="2">AC peak DC</th> <th rowspan="2">Load voltage</th> <th rowspan="2">Output</th> </tr> </thead> <tbody> <tr> <td>10,000</td> <td rowspan="14"> Continuous load current AC peak/ DC * 6-pin type connection C: DC </td> </tr> <tr><td>9,000</td></tr> <tr><td>8,000</td></tr> <tr><td>7,000</td></tr> <tr><td>6,000</td></tr> <tr><td>5,000</td></tr> <tr><td>4,000</td></tr> <tr><td>3,000</td></tr> <tr><td>2,000</td></tr> <tr><td>1,000</td></tr> <tr><td>900</td></tr> <tr><td>800</td></tr> <tr><td>700</td></tr> <tr><td>600</td></tr> <tr><td>500</td></tr> <tr><td>400</td></tr> <tr><td>300</td></tr> <tr><td>200</td></tr> <tr><td>100</td></tr> </tbody> </table>	AC peak DC	Load voltage	Output	10,000	Continuous load current AC peak/ DC * 6-pin type connection C: DC	9,000	8,000	7,000	6,000	5,000	4,000	3,000	2,000	1,000	900	800	700	600	500	400	300	200	100
AC peak DC	Load voltage	Output																									
			10,000	Continuous load current AC peak/ DC * 6-pin type connection C: DC																							
9,000																											
8,000																											
7,000																											
6,000																											
5,000																											
4,000																											
3,000																											
2,000																											
1,000																											
900																											
800																											
700																											
600																											
500																											
400																											
300																											
200																											
100																											
30 mA		50 mA		LED forward current																							
2,500 VAC 50/60 Hz for 1 min.		5,000 VAC 50/60 Hz for 1 min.		Dielectric strength between I/O																							
-40 to +85°C (with no icing or condensation)				Ambient operating temperature																							
0.15 Ω	Connection A: 0.06 Ω Connection B: 0.015 Ω (typical) Connection C: 0.008 Ω (typical)	2 Ω		Maximum output ON resistance																							
1 μA (at 40 VDC)		1 μA (at 60 VDC)		Maximum OFF leakage current																							
●				Surface-mounting terminals																							
●				PCB terminals																							
PCB mounting or Surface mounting				Mounting method																							
UL				Applicable standards																							
Compliant				RoHS compliance																							
Approx. 0.25 g	Approx. 0.4 g	Approx. 0.25 g		Weight																							
110	115	62	147	Page																							

* Only basic specifications are given in this table. Refer to the reference page given in the table for detailed specifications and precautions before you attempt to use a Relay.
 ** Refer to pages 218 to 220 for detailed information on models certified for standards.

Product Table

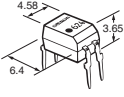
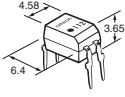
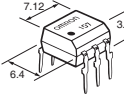
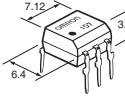
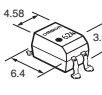
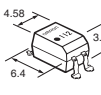
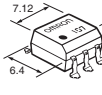
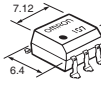
Application		For PCBs				
Model	G3VM-61AY1 G3VM-61DY1	G3VM-61AR G3VM-61DR	G3VM-61B1 G3VM-61E1	G3VM-61BR G3VM-61ER		
Contact form	1a (SPST-NO)					
Package (Unit : mm, Average)						
						
Features	<ul style="list-style-type: none"> • Small and High-dielectric-strength Type • Load voltage: 60 V • Dielectric strength between I/O: 5,000 VAC 	<ul style="list-style-type: none"> • High-current and Low-ON-resistance Type • Load voltage: 60 V • Continuous load current : 2 A max. 	<ul style="list-style-type: none"> • General-purpose Type • Load voltage: 60 V 	<ul style="list-style-type: none"> • High-current and Low-ON-resistance Type • Load voltage: 60 V • Continuous load current: 2.5 A max. 		
Isolation method						
Photodiode coupler						
60 V						
Absolute maximum ratings	Load voltage	AC peak				
		DC				
	Output	Continuous load current AC peak/ DC * 6-pin type connection C: DC	10,000			
			9,000			
			8,000			
			7,000			
			6,000			
	5,000					
	4,000					
	3,000					
2,000						
1,000		2,000 mA				
900						
800						
700						
600						
500	500 mA					
400						
300						
200						
100						
Input	LED forward current	30 mA		50 mA		
Dielectric strength between I/O		5,000 VAC 50/60 Hz for 1 min.		2,500 VAC 50/60 Hz for 1 min.		
Ambient operating temperature		-40 to +85°C (with no icing or condensation)				
Electrical characteristics	Output	Maximum output ON resistance	2 Ω	0.2 Ω	Connection A: 2 Ω Connection B: 1 Ω Connection C: 0.25 Ω (typical)	0.1 Ω
		Maximum OFF leakage current	1 μA (at 60 VDC)			10 nA (at 60 VDC)
Terminal structure	Surface-mounting terminals	●				
	PCB terminals	●				
Mounting method		PCB mounting or Surface mounting				
Applicable standards		UL				
RoHS compliance		Compliant				
Weight		Approx. 0.25 g		Approx. 0.4 g		
Page		147	110	62	115	

* Only basic specifications are given in this table. Refer to the reference page given in the table for detailed specifications and precautions before you attempt to use a Relay.
* Refer to pages 218 to 220 for detailed information on models certified for standards.

Product Table

For PCBs				Application																								
G3VM-61BR1 G3VM-61ER1	G3VM-61CR1 G3VM-61FR1	G3VM-62C1 G3VM-62F1	G3VM-101AR G3VM-101DR	Model																								
1a (SPST-NO)			2a (DPST-NO)	1a (SPST-NO)																								
				Contact form																								
				Package (Unit : mm, Average)																								
DIP6	NEW DIP8	DIP8	DIP4																									
<ul style="list-style-type: none"> • High-current and Low-ON-resistance Type • Load voltage: 60 V • Continuous load current : 3 A (6 A) max. * * Values in parentheses are for connection C. 	<ul style="list-style-type: none"> • High-current and Low-ON-resistance Type • Load voltage: 60 V • Continuous load current : 5 A (10 A) max. * * Values in parentheses are for connection C. 	<ul style="list-style-type: none"> • Multi-contact-pair Type • Load voltage: 60 V • Contact form: 2a (DPST-NO) 	<ul style="list-style-type: none"> • High-current and Low-ON-resistance Type • Load voltage: 100 V • Continuous load current: 1 A max. 	Features																								
Photodiode coupler				Isolation method																								
60 V		100 V		<table border="1"> <thead> <tr> <th>AC peak</th> <th>Load voltage</th> </tr> <tr> <th>DC</th> <th></th> </tr> </thead> <tbody> <tr><td>10,000</td><td rowspan="14"> Continuous load current AC peak/ DC * 6-pin type connection C: DC </td></tr> <tr><td>9,000</td></tr> <tr><td>8,000</td></tr> <tr><td>7,000</td></tr> <tr><td>6,000</td></tr> <tr><td>5,000</td></tr> <tr><td>4,000</td></tr> <tr><td>3,000</td></tr> <tr><td>2,000</td></tr> <tr><td>1,000</td></tr> <tr><td>900</td></tr> <tr><td>800</td></tr> <tr><td>700</td></tr> <tr><td>600</td></tr> <tr><td>500</td></tr> <tr><td>400</td></tr> <tr><td>300</td></tr> <tr><td>200</td></tr> <tr><td>100</td></tr> </tbody> </table>	AC peak	Load voltage	DC		10,000	Continuous load current AC peak/ DC * 6-pin type connection C: DC	9,000	8,000	7,000	6,000	5,000	4,000	3,000	2,000	1,000	900	800	700	600	500	400	300	200	100
AC peak	Load voltage																											
DC																												
10,000	Continuous load current AC peak/ DC * 6-pin type connection C: DC																											
9,000																												
8,000																												
7,000																												
6,000																												
5,000																												
4,000																												
3,000																												
2,000																												
1,000																												
900																												
800																												
700																												
600																												
500																												
400																												
300																												
200																												
100																												
				Absolute maximum ratings																								
30 mA		50 mA		LED forward current																								
2.500 VAC 50/60 Hz for 1 min.				Dielectric strength between I/O																								
-40 to +85°C (with no icing or condensation)				Ambient operating temperature																								
Connection A: 0.07 Ω Connection B: 0.02 Ω (typical) Connection C: 0.01 Ω (typical)	Connection A: 0.05 Ω Connection B: 0.025 Ω Connection C: 0.013 Ω	2 Ω	0.7 Ω	Maximum output ON resistance																								
1 μA (at 60 VDC)	10 μA (at 60 VDC)	1 μA (at 60 VDC)	1 μA (at 100 VDC)	Maximum OFF leakage current																								
●				Surface-mounting terminals																								
●				PCB terminals																								
PCB mounting or Surface mounting				Mounting method																								
UL				Applicable standards																								
Compliant				RoHS compliance																								
Approx. 0.4 g	Approx. 0.54 g		Approx. 0.25 g	Weight																								
115	121	98	110	Page																								

* Only basic specifications are given in this table. Refer to the reference page given in the table for detailed specifications and precautions before you attempt to use a Relay.
 * Refer to pages 218 to 220 for detailed information on models certified for standards.

Product Table

Application		For PCBs				
Model	G3VM-101BR G3VM-101ER	G3VM-101CR G3VM-101FR	G3VM-201AY G3VM-201DY	G3VM-201AY1 G3VM-201DY1		
Contact form	1a (SPST-NO)					
Package (Unit : mm, Average)						
Features	<ul style="list-style-type: none"> • High-current and Low-ON-resistance Type • Load voltage: 100 V • Continuous load current : 2 A (4 A) max. * * Values in parentheses are for connection C. 	<ul style="list-style-type: none"> • High-current and Low-ON-resistance Type • Load voltage: 100 V • Continuous load current : 3 A (6 A) max. * * Values in parentheses are for connection C. 	<ul style="list-style-type: none"> • Small and High-dielectric-strength Type • Load voltage: 200 V • Dielectric strength between I/O: 5,000 VAC • Trigger LED forward current : 2 mA max. 	<ul style="list-style-type: none"> • Small and High-dielectric-strength Type • Load voltage: 200 V • Dielectric strength between I/O: 5,000 VAC 		
Isolation method		Photodiode coupler				
Absolute maximum ratings	Output	Load voltage	100 V		200 V	
		AC peak DC	100 V		200 V	
	Continuous load current AC peak/ DC	AC peak	2,000 mA	3,000 mA	6,000 mA	250 mA
		DC	4,000 mA	6,000 mA	6,000 mA	250 mA
	* 6-pin type connection C:					
	DC					
	Input	LED forward current	30 mA			
	Dielectric strength between I/O		2,500 VAC 50/60 Hz for 1 min.		5,000 VAC 50/60 Hz for 1 min.	
	Ambient operating temperature		-40 to +85°C (with no icing or condensation)	-40 to +110°C (with no icing or condensation)	-40 to +85°C (with no icing or condensation)	
	Electrical characteristics	Output	Maximum output ON resistance	Connection A: 0.2 Ω Connection B: 0.05 Ω (typical) Connection C: 0.025 Ω (typical)	Connection A: 0.15 Ω Connection B: 0.075 Ω Connection C: 0.075 Ω	8 Ω
Maximum OFF leakage current			1 μA (at 100 VDC)		1 μA (at 200 VDC)	
Terminal structure	Surface-mounting terminals	●				
	PCB terminals	●				
Mounting method		PCB mounting or Surface mounting				
Applicable standards		UL				
RoHS compliance		Compliant				
Weight		Approx. 0.4 g	Approx. 0.54 g	Approx. 0.25 g		
Page		115	121	147	147	

* Only basic specifications are given in this table. Refer to the reference page given in the table for detailed specifications and precautions before you attempt to use a Relay.
* Refer to pages 218 to 220 for detailed information on models certified for standards.

Product Table

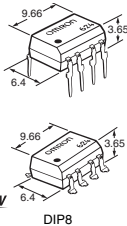
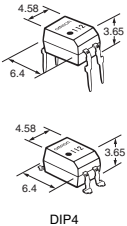
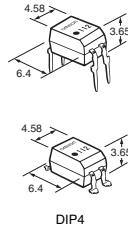
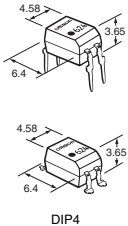
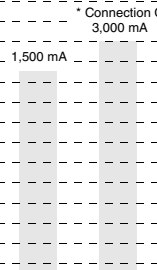
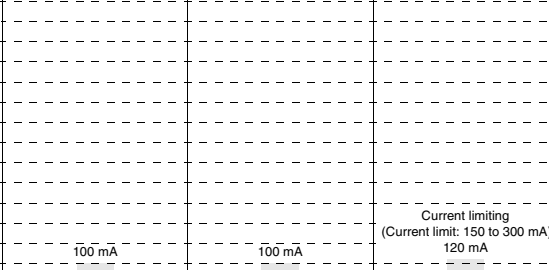
For PCBs				Application
G3VM-201CR G3VM-201FR	G3VM-351AY G3VM-351DY	G3VM-351AY1 G3VM-351DY1	G3VM-2L G3VM-2FL	Model
1a (SPST-NO)				Contact form
				Package (Unit : mm, Average)
DIP8	DIP4	DIP4	DIP4	
<ul style="list-style-type: none"> • High-current and Low-ON-resistance Type • Load voltage: 200 V • Continuous load current : 1.5 A (3 A) max. * * Values in parentheses are for connection C. 	<ul style="list-style-type: none"> • Small and High-dielectric-strength Type • Load voltage: 350 V • Dielectric strength between I/O: 5,000 VAC • Trigger LED forward current : 2 mA max. 	<ul style="list-style-type: none"> • Small and High-dielectric-strength Type • Load voltage: 350 V • Dielectric strength between I/O: 5,000 VAC 	<ul style="list-style-type: none"> • Current-limiting Type • Load voltage: 350 V • Current limit: 150 to 300 mA 	Features
Photodiode coupler				Isolation method
200 V		350 V		AC peak DC
				Output Absolute maximum ratings Continuous load current AC peak/ DC * 6-pin type connection C: DC
1,500 mA		100 mA		10,000
3,000 mA		100 mA		9,000
4,000 mA		100 mA		8,000
5,000 mA		100 mA		7,000
6,000 mA		100 mA		6,000
7,000 mA		100 mA		5,000
8,000 mA		100 mA		4,000
9,000 mA		100 mA		3,000
10,000 mA		100 mA		2,000
11,000 mA		100 mA		1,000
12,000 mA		100 mA		900
13,000 mA		100 mA		800
14,000 mA		100 mA		700
15,000 mA		100 mA		600
16,000 mA		100 mA		500
17,000 mA		100 mA		400
18,000 mA		100 mA		300
19,000 mA		100 mA		200
20,000 mA		100 mA		100
30 mA		50 mA		Current limiting (Current limit: 150 to 300 mA) 120 mA
2,500 VAC 50/60 Hz for 1 min.		5,000 VAC 50/60 Hz for 1 min.		LED forward current
-40 to +85°C (with no icing or condensation)		35 Ω		Dielectric strength between I/O
Ambient operating temperature		Maximum output ON resistance		Input
Connection A: 0.5 Ω Connection B: 0.25 Ω Connection C: 0.25 Ω		1 μA (at 350 VDC)		Output Electrical characteristics
1 μA (at 200 VDC)		●		Maximum OFF leakage current
●		●		Surface-mounting terminals
PCB mounting or Surface mounting		●		PCB terminals
UL		Compliant		Mounting method
Approx. 0.54 g		Approx. 0.25 g		Applicable standards
121		147		RoHS compliance
147		159		Weight
147		159		Page

* Only basic specifications are given in this table. Refer to the reference page given in the table for detailed specifications and precautions before you attempt to use a Relay.
* Refer to pages 218 to 220 for detailed information on models certified for standards.

Product Table

Application		For PCBs				
Model	G3VM-351A G3VM-351D	G3VM-353A G3VM-353D	G3VM-351B G3VM-351E	G3VM-353B G3VM-353E		
Contact form	1a (SPST-NO)	1b (SPST-NC)	1a (SPST-NO)	1b (SPST-NC)		
Package (Unit : mm, Average)						
	DIP4	DIP4	DIP6	DIP6		
Features	<ul style="list-style-type: none"> General-purpose Type Load voltage: 350 V 	<ul style="list-style-type: none"> General-purpose Type Load voltage: 350 V Contact form: 1b (SPST-NC) 	<ul style="list-style-type: none"> General-purpose Type Load voltage: 350 V 	<ul style="list-style-type: none"> General-purpose Type Load voltage: 350 V Contact form: 1b (SPST-NC) 		
Isolation method		Photodiode coupler				
Absolute maximum ratings	Output	Load voltage	350 V			
		AC peak	350 V			
		DC	350 V			
		Continuous load current	10,000	10,000	10,000	10,000
		AC peak/ DC	9,000	9,000	9,000	9,000
			8,000	8,000	8,000	8,000
			7,000	7,000	7,000	7,000
			6,000	6,000	6,000	6,000
			5,000	5,000	5,000	5,000
			4,000	4,000	4,000	4,000
	3,000	3,000	3,000	3,000		
	2,000	2,000	2,000	2,000		
	1,000	1,000	1,000	1,000		
	900	900	900	900		
	800	800	800	800		
	700	700	700	700		
	600	600	600	600		
	500	500	500	500		
	400	400	400	400		
	300	300	300	300		
	200	120 mA	150 mA	120 mA	150 mA	
	100	100	100	100	100	
	Input	LED forward current	50 mA			
		Dielectric strength between I/O	2,500 VAC 50/60 Hz for 1 min.			
		Ambient operating temperature	-40 to +85°C (with no icing or condensation)			
Electrical characteristics	Output	Maximum output ON resistance	50 Ω	25 Ω	Connection A: 50 Ω Connection B: 40 Ω Connection C: 20 Ω	Connection A: 25 Ω Connection B: 14 Ω Connection C: 7 Ω
		Maximum OFF leakage current	1 μA (at 350 VDC)			
Terminal structure	Surface-mounting terminals	●				
	PCB terminals	●				
Mounting method	PCB mounting or Surface mounting					
Applicable standards	UL and BSI (EN 60950)	UL				
RoHS compliance	Compliant					
Weight	Approx. 0.25 g		Approx. 0.4 g			
Page	62	62	62	62		

* Only basic specifications are given in this table. Refer to the reference page given in the table for detailed specifications and precautions before you attempt to use a Relay.
* Refer to pages 218 to 220 for detailed information on models certified for standards.

Product Table

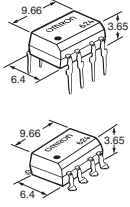
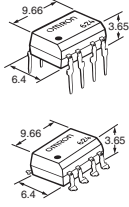
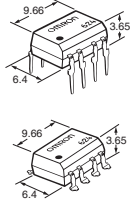
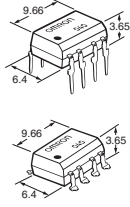
For PCBs				Application																						
G3VM-355CR G3VM-355FR	G3VM-352C G3VM-352F	G3VM-WL G3VM-WFL	G3VM-354C G3VM-354F	Model																						
1a1b (SPST-NO/SPST-NC)	2a (DPST-NO)			Contact form																						
				Package (Unit : mm, Average)																						
DIP8	DIP8	DIP8	DIP8																							
<ul style="list-style-type: none"> Multi-contact-pair Type Load voltage: 350 V Contact form: 1a1b (SPST-NO/SPST-NC) 	<ul style="list-style-type: none"> Multi-contact-pair Type Load voltage: 350 V Contact form: 2a (DPST-NO) 	<ul style="list-style-type: none"> Current-limiting Type Load voltage: 350 V Current limit: 150 to 300 mA 	<ul style="list-style-type: none"> Multi-contact-pair Type Load voltage: 350 V Contact form: 2b (DPST-NC) 	Features																						
Photodiode coupler				Isolation method																						
350 V				<table border="1"> <thead> <tr> <th>AC peak DC</th> <th>Load voltage</th> </tr> </thead> <tbody> <tr><td>10,000</td><td rowspan="15">Continuous load current AC peak/ DC * 6-pin type connection C: DC</td></tr> <tr><td>9,000</td></tr> <tr><td>8,000</td></tr> <tr><td>7,000</td></tr> <tr><td>6,000</td></tr> <tr><td>5,000</td></tr> <tr><td>4,000</td></tr> <tr><td>3,000</td></tr> <tr><td>2,000</td></tr> <tr><td>1,000</td></tr> <tr><td>900</td></tr> <tr><td>800</td></tr> <tr><td>700</td></tr> <tr><td>600</td></tr> <tr><td>500</td></tr> <tr><td>400</td></tr> <tr><td>300</td></tr> <tr><td>200</td></tr> <tr><td>100</td></tr> </tbody> </table>	AC peak DC	Load voltage	10,000	Continuous load current AC peak/ DC * 6-pin type connection C: DC	9,000	8,000	7,000	6,000	5,000	4,000	3,000	2,000	1,000	900	800	700	600	500	400	300	200	100
AC peak DC	Load voltage																									
10,000	Continuous load current AC peak/ DC * 6-pin type connection C: DC																									
9,000																										
8,000																										
7,000																										
6,000																										
5,000																										
4,000																										
3,000																										
2,000																										
1,000																										
900																										
800																										
700																										
600																										
500																										
400																										
300																										
200																										
100																										
120 mA	120 mA	Current limiting (Current limit: 150 to 300 mA) 120 mA	150 mA																							
50 mA				LED forward current																						
2,500 VAC 50/60 Hz for 1 min.				Dielectric strength between I/O																						
-40 to +85°C (with no icing or condensation)				Ambient operating temperature																						
25 Ω	50 Ω	35 Ω	25 Ω	Maximum output ON resistance																						
1 μA (at 350 VDC)				Maximum OFF leakage current																						
●				Surface-mounting terminals																						
●				PCB terminals																						
PCB mounting or Surface mounting				Mounting method																						
---	UL and BSI (EN 60950)	UL		Applicable standards																						
Compliant				RoHS compliance																						
Approx. 0.54 g				Weight																						
98	98	159	98	Page																						

* Only basic specifications are given in this table. Refer to the reference page given in the table for detailed specifications and precautions before you attempt to use a Relay.
* Refer to pages 218 to 220 for detailed information on models certified for standards.

Product Table

Application		For PCBs			
Model	G3VM-401A G3VM-401D	G3VM-401AY G3VM-401DY	G3VM-401AY1 G3VM-401DY1	G3VM-401B G3VM-401E	
Contact form	1a (SPST-NO)				
Package (Unit : mm, Average)					
	DIP4	DIP4	DIP4	DIP6	
Features	<ul style="list-style-type: none"> General-purpose Type Load voltage: 400 V 	<ul style="list-style-type: none"> Small and High-dielectric-strength Type Load voltage: 400 V Dielectric strength between I/O: 5,000 VAC Trigger LED forward current : 2 mA max. 	<ul style="list-style-type: none"> Small and High-dielectric-strength Type Load voltage: 400 V Dielectric strength between I/O: 5,000 VAC 	<ul style="list-style-type: none"> General-purpose Type Load voltage: 400 V 	
Isolation method	Photodiode coupler				
Absolute maximum ratings	Load voltage	400 V			
	AC peak DC	400 V			
	Output	10,000			
		9,000			
		8,000			
		7,000			
		6,000			
		5,000			
		4,000			
		3,000			
	2,000				
	1,000				
	900				
	800				
	700				
	600				
	500				
	400				
	300				
	200				
	100	120 mA	120 mA	120 mA	120 mA
Input	LED forward current	50 mA	30 mA		50 mA
	Dielectric strength between I/O	2,500 VAC 50/60 Hz for 1 min.		5,000 VAC 50/60 Hz for 1 min.	2,500 VAC 50/60 Hz for 1 min.
	Ambient operating temperature	-40 to +85°C (with no icing or condensation)			
Electrical characteristics	Output	Maximum output ON resistance	35 Ω		Connection A: 35 Ω Connection B: 20 Ω Connection C: 10 Ω
		Maximum OFF leakage current	1 μA (at 400 VDC)		
Terminal structure	Surface-mounting terminals	●			
	PCB terminals	●			
	Mounting method	PCB mounting or Surface mounting			
	Applicable standards	UL			
	RoHS compliance	Compliant			
	Weight	Approx. 0.25 g			Approx. 0.4 g
	Page	62	147	147	62

* Only basic specifications are given in this table. Refer to the reference page given in the table for detailed specifications and precautions before you attempt to use a Relay.
* Refer to pages 218 to 220 for detailed information on models certified for standards.

Product Table

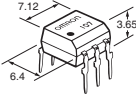
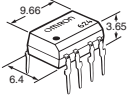
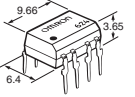
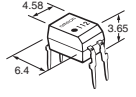
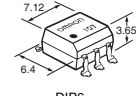
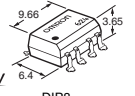
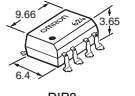
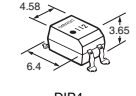
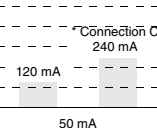
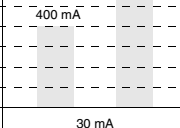
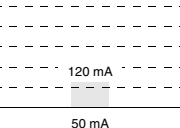
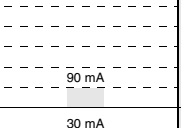
For PCBs				Application																						
G3VM-401BY G3VM-401EY	G3VM-401CR G3VM-401FR	G3VM-402C G3VM-402F	G3VM-601AY G3VM-601DY	Model																						
1a (SPST-NO)			2a (DPST-NO)	1a (SPST-NO)																						
				Contact form																						
				Package (Unit : mm, Average)																						
	NEW 																									
<ul style="list-style-type: none"> High-dielectric-strength Type Load voltage: 400 V Dielectric strength between I/O: 5,000 VAC 	<ul style="list-style-type: none"> High-current and Low-ON-resistance Type Load voltage: 400 V Continuous load current : 0.4 A (0.8 A) max. * * Values in parentheses are for connection C. 	<ul style="list-style-type: none"> Multi-contact-pair Type Load voltage: 400 V Contact form: 2a (DPST-NO) 	<ul style="list-style-type: none"> Small and High-dielectric-strength Type Load voltage :600 V Dielectric strength between I/O: 5,000 VAC Trigger LED forward current : 2 mA max. 	Features																						
Photodiode coupler				Isolation method																						
400 V		600 V		<table border="1"> <thead> <tr> <th>AC peak</th> <th>Load voltage</th> </tr> </thead> <tbody> <tr><td>10,000</td><td rowspan="14"> Continuous load current AC peak/ DC * 6-pin type connection C: DC </td></tr> <tr><td>9,000</td></tr> <tr><td>8,000</td></tr> <tr><td>7,000</td></tr> <tr><td>6,000</td></tr> <tr><td>5,000</td></tr> <tr><td>4,000</td></tr> <tr><td>3,000</td></tr> <tr><td>2,000</td></tr> <tr><td>1,000</td></tr> <tr><td>900</td></tr> <tr><td>800</td></tr> <tr><td>700</td></tr> <tr><td>600</td></tr> <tr><td>500</td></tr> <tr><td>400</td></tr> <tr><td>300</td></tr> <tr><td>200</td></tr> <tr><td>100</td></tr> </tbody> </table>	AC peak	Load voltage	10,000	Continuous load current AC peak/ DC * 6-pin type connection C: DC	9,000	8,000	7,000	6,000	5,000	4,000	3,000	2,000	1,000	900	800	700	600	500	400	300	200	100
AC peak	Load voltage																									
10,000	Continuous load current AC peak/ DC * 6-pin type connection C: DC																									
9,000																										
8,000																										
7,000																										
6,000																										
5,000																										
4,000																										
3,000																										
2,000																										
1,000																										
900																										
800																										
700																										
600																										
500																										
400																										
300																										
200																										
100																										
				Absolute maximum ratings Output Input																						
5,000 VAC 50/60 Hz for 1 min.	2,500 VAC 50/60 Hz for 1 min.	5,000 VAC 50/60 Hz for 1 min.	5,000 VAC 50/60 Hz for 1 min.	LED forward current																						
-40 to +85°C (with no icing or condensation)				Ambient operating temperature																						
Connection A: 35 Ω Connection B: 20 Ω Connection C: 10 Ω	Connection A: 5 Ω Connection B: 2.5 Ω Connection C: 1.3 Ω	35 Ω	65 Ω	Maximum output ON resistance																						
1 μA (at 400 VDC)			1 μA (at 600 VDC)	Maximum OFF leakage current																						
●				Surface-mounting terminals																						
●				PCB terminals																						
PCB mounting or Surface mounting				Mounting method																						
UL				Applicable standards																						
Compliant				RoHS compliance																						
Approx. 0.4 g	Approx. 0.54 g	Approx. 0.25 g	Approx. 0.25 g	Weight																						
155	121	98	147	Page																						

* Only basic specifications are given in this table. Refer to the reference page given in the table for detailed specifications and precautions before you attempt to use a Relay.
 * Refer to pages 218 to 220 for detailed information on models certified for standards.

Product Table

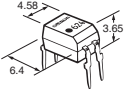
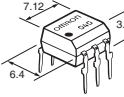
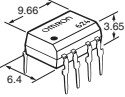
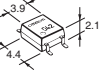
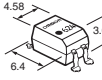
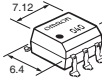
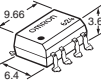
Application		For PCBs				
Model	G3VM-601AY1 G3VM-601DY1	G3VM-601BY G3VM-601EY	G3VM-601CR G3VM-601FR	G3VM-21GR		
Contact form	1a (SPST-NO)					
Package (Unit : mm, Average)						
						
Features	<ul style="list-style-type: none"> Small and High-dielectric-strength Type Load voltage: 600 V Dielectric strength between I/O: 5,000 VAC 	<ul style="list-style-type: none"> High-dielectric-strength Type Load voltage: 600 V Dielectric strength between I/O: 5,000 VAC 	<ul style="list-style-type: none"> High-current and Low-ON-resistance Type Load voltage: 600 V Continuous load current : 0.6 A (1.2 A) max. * * Values in parentheses are for connection C. 	<ul style="list-style-type: none"> Low-output-capacitance and Low-ON-resistance Type (with Low C × R) Load voltage: 20 V Low C × R = 5 pF · Ω C_{OFF} (typical) = 1 pF 		
Isolation method		Photodiode coupler				
Absolute maximum ratings	Output	Load voltage	600 V		20 V	
		AC peak DC				
	Input	Continuous load current AC peak / DC * 6-pin type connection C: DC	10,000			
			9,000			
			8,000			
			7,000			
			6,000			
			5,000			
			4,000			
			3,000			
2,000						
1,000						
900			Connection C 1,200 mA			
800						
700						
600			600 mA			
500						
400						
300			Connection C 200 mA			
200						
100				160 mA		
LED forward current	30 mA	50 mA	30 mA	50 mA		
Dielectric strength between I/O	5,000 VAC 50/60 Hz for 1 min.		2,500 VAC 50/60 Hz for 1 min.	1,500 VAC 50/60 Hz for 1 min.		
Ambient operating temperature	-40 to +85°C (with no icing or condensation)			-20 to +85°C (with no icing or condensation)		
Electrical characteristics	Output	Maximum output ON resistance	Connection A: 45 Ω Connection B: 35 Ω Connection C: 18 Ω	Connection A: 2 Ω Connection B: 1 Ω Connection C: 0.5 Ω	8 Ω	
		Maximum OFF leakage current	1 μA (at 600 VDC)		10 μA (at 600 VDC)	1 nA (at 20 VDC)
Terminal structure	Surface-mounting terminals	●		● (SOP)		
	PCB terminals	●				
Mounting method	PCB mounting or Surface mounting			Surface mounting		
Applicable standards	UL					
RoHS compliance	Compliant					
Weight	Approx. 0.25 g	Approx. 0.4 g	Approx. 0.54 g	Approx. 0.1 g		
Page	147	155	121	165		

* Only basic specifications are given in this table. Refer to the reference page given in the table for detailed specifications and precautions before you attempt to use a Relay.
* Refer to pages 218 to 220 for detailed information on models certified for standards.

Product Table

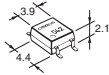
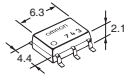
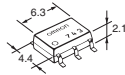
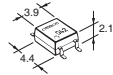
For PCBs				Application
G3VM-21GR1	G3VM-21HR	G3VM-31HR	G3VM-41GR6	Model
1a (SPST-NO)				Contact form
				Package (Unit : mm, Average)
SOP4	SOP6	NEW SOP6	SOP4	Features
<ul style="list-style-type: none"> • Low-output-capacitance and Low-ON-resistance Type (with Low C x R) • Load voltage: 20 V • Low C x R = 5 pF · Ω • Ron (typical) = 1 Ω 	<ul style="list-style-type: none"> • High-current and Low-ON-resistance Type • Load voltage: 20 V • Continuous load current : 2.5 A (5 A) max. * * Values in parentheses are for connection C. 	<ul style="list-style-type: none"> • High-current and Low-ON-resistance Type • Load voltage: 30 V • Continuous load current : 4 A (8 A) max. * * Values in parentheses are for connection C. 	<ul style="list-style-type: none"> • Low-output-capacitance and Low-ON-resistance Type (with Low C x R) • Load voltage: 40 V • Low C x R = 10 pF · Ω • Coff (typical) = 1 pF 	Features
Photodiode coupler				Isolation method
20 V		30 V		40 V
				AC peak DC
				Load voltage
				Output
				Absolute maximum ratings
				Input
				Output
				Electrical characteristics
				Terminal structure
				Mounting method
				Applicable standards
				RoHS compliance
				Weight
				Page
				Product Table

* Only basic specifications are given in this table. Refer to the reference page given in the table for detailed specifications and precautions before you attempt to use a Relay.
* Refer to pages 218 to 220 for detailed information on models certified for standards.

Product Table

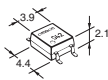
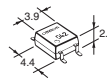
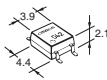
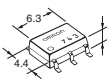
Application		For PCBs				
Model	G3VM-41GR4	G3VM-41GR5	G3VM-41GR8	G3VM-41HR		
Contact form	1a (SPST-NO)					
Package (Unit : mm, Average)						
Features	<ul style="list-style-type: none"> • Low-output-capacitance and Low-ON-resistance Type (with Low C x R) • Load voltage: 40 V • Low C x R = 10 pF · Ω • Ron (typical) = 2 Ω 	<ul style="list-style-type: none"> • Low-output-capacitance and Low-ON-resistance Type (with Low C x R) • Load voltage: 40 V • Low C x R = 10 pF · Ω • Ron (typical) = 1 Ω 	<ul style="list-style-type: none"> • High-current and Low-ON-resistance Type • Load voltage: 40 V • Continuous load current: 1 A max. 	<ul style="list-style-type: none"> • High-current and Low-ON-resistance Type • Load voltage: 40 V • Continuous load current : 2.5 A (5 A) max. * * Values in parentheses are for connection C. 		
Isolation method		Photodiode coupler				
Absolute maximum ratings	Output	Load voltage	40 V			
		AC peak DC				
	Continuous load current AC peak/DC * 6-pin type connection C: DC	10,000				
		9,000				
		8,000				
		7,000				
		6,000				* Connection C
		5,000				5,000 mA
		4,000				
		3,000				2,500 mA
2,000						
1,000			1,000 mA			
900						
800						
700						
600						
500						
400						
300	250 mA					
200		300 mA				
100						
Input	LED forward current	50 mA		30 mA		
Dielectric strength between I/O		1,500 VAC 50/60 Hz for 1 min.				
Ambient operating temperature		-20 to +85°C (with no icing or condensation)		-40 to +85°C (with no icing or condensation)		
Electrical characteristics	Output	Maximum output ON resistance	3 Ω	1.5 Ω	0.13 Ω	
	Maximum OFF leakage current	1 nA (at 30 VDC)			10 nA (at 40 VDC)	
Terminal structure	Surface-mounting terminals	● (SOP)				
	PCB terminals					
Mounting method		Surface mounting				
Applicable standards		UL				
RoHS compliance		Compliant				
Weight		Approx. 0.1 g			Approx. 0.13 g	
Page		165	165	127	131	

* Only basic specifications are given in this table. Refer to the reference page given in the table for detailed specifications and precautions before you attempt to use a Relay.
* Refer to pages 218 to 220 for detailed information on models certified for standards.

Product Table

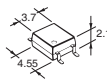
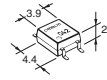
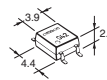
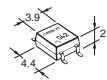
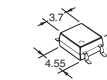
For PCBs					Application	
G3VM-61VY1	G3VM-61G1	G3VM-61G2	G3VM-61G3	G3VM-61VY2	Model	
1a (SPST-NO)					Contact form	
					Package (Unit : mm, Average)	
Special SOP4	SOP4	SOP4	SOP4	NEW Special SOP4		
<ul style="list-style-type: none"> General-purpose Type Load voltage: 60 V Dielectric strength between I/O: 3,750 VAC 	<ul style="list-style-type: none"> General-purpose Type Load voltage: 60 V 	<ul style="list-style-type: none"> General-purpose Type Load voltage: 60 V Trigger LED forward current : 1 mA max. 	<ul style="list-style-type: none"> General-purpose Type Load voltage: 60 V Trigger LED forward current : 0.2 mA max. 	<ul style="list-style-type: none"> General-purpose Type Continuous load current : 0.5A max. Dielectric strength between I/O: 3,750 VAC High Ambient operating temperature: -40 to +110°C 	Features	
Photodiode coupler					Isolation method	
60 V					AC peak DC	
					Load voltage	
					Continuous load current AC peak/ DC * 6-pin type connection C: DC	
						10,000
						9,000
						8,000
						7,000
						6,000
						5,000
						4,000
						3,000
						2,000
						1,000
						900
						800
					700	
					600	
					500	
					400	
					300	
					200	
					100	
100 mA	400 mA	400 mA	400 mA	500 mA	Output	
30 mA	50 mA		30 mA		LED forward current	
3,750 VAC 50/60 Hz for 1 min.	1,500 VAC 50/60 Hz for 1 min.			3,750 VAC 50/60 Hz for 1 min.	Dielectric strength between I/O	
-40 to +85°C (with no icing or condensation)					-40 to +110°C (with no icing or condensation)	Ambient operating temperature
50 Ω	2 Ω				Maximum output ON resistance	
1 μA (at 60 VDC)					Maximum OFF leakage current	
● (SOP)					Surface-mounting terminals	
					PCB terminals	
Surface mounting					Mounting method	
UL					Applicable standards	
Compliant					RoHS compliance	
Approx. 0.1 g					Weight	
68	68	68	68	68	Page	

* Only basic specifications are given in this table. Refer to the reference page given in the table for detailed specifications and precautions before you attempt to use a Relay.
 * Refer to pages 218 to 220 for detailed information on models certified for standards.

Product Table

Application		For PCBs					
Model	G3VM-61VY3	G3VM-61GR1	G3VM-61GR2	G3VM-61VR	G3VM-63G		
Contact form	1a (SPST-NO)				1b (SPST-NC)		
Package (Unit : mm, Average)							
	NEW Special SOP4	SOP4	NEW SOP4	NEW Special SOP4	NEW SOP4		
Features	<ul style="list-style-type: none"> • General-purpose Type • Continuous load current : 0.7A max. • Dielectric strength between I/O: 3,750 VAC • High Ambient operating temperature: -40 to +110°C 	<ul style="list-style-type: none"> • High-current and Low-ON-resistance Type • Load voltage: 60 V • Continuous load current : 1 A max. 	<ul style="list-style-type: none"> • High-current and Low-ON-resistance Type • Load voltage: 60 V • Continuous load current : 1.7 A max. 	<ul style="list-style-type: none"> • High-current and Low-ON-resistance Type • Continuous load current : 1.4 A max. • Dielectric strength between I/O: 3,750 VAC • High Ambient operating temperature: -40 to +110°C 	<ul style="list-style-type: none"> • General-purpose Type • Load voltage: 60 V • Contact form: 1b (SPST-NC) 		
Isolation method							
Photodiode coupler							
Load voltage		60 V					
AC peak DC							
Absolute maximum ratings	Output	10,000					
		9,000					
		8,000					
		7,000					
		6,000					
		5,000					
		4,000					
		3,000					
		2,000					
		1,000		1,000 mA	1,700 mA	1,400 mA	
900	700 mA						
800							
700							
600							
500							
400							
300							
200							
100					500 mA		
Input	LED forward current	30 mA	50 mA	30 mA	50 mA		
	Dielectric strength between I/O	3,750 VAC 50/60 Hz for 1 min.	1,500 VAC 50/60 Hz for 1 min.	3,750 VAC 50/60 Hz for 1 min.	1,500 VAC 50/60 Hz for 1 min.		
	Ambient operating temperature	-40 to +110°C (with no icing or condensation)	-20 to +85°C (with no icing or condensation)	-40 to +85°C (with no icing or condensation)	-40 to +110°C (with no icing or condensation)		
Electrical characteristics	Output	Maximum output ON resistance	2 Ω	0.7 Ω	0.13 Ω	0.25 Ω	2.5 Ω
		Maximum OFF leakage current	1 μA (at 60 VDC)	0.1 μA (at 60 VDC)	0.01 μA (at 60 VDC)		1 μA (at 60 VDC)
Terminal structure	Surface-mounting terminals	● (SOP)					
	PCB terminals						
Mounting method		Surface mounting					
Applicable standards		UL					
RoHS compliance		Compliant					
Weight		Approx. 0.1 g	Approx. 0.13 g		Approx. 0.1 g		
Page		68	127	127	127	68	

* Only basic specifications are given in this table. Refer to the reference page given in the table for detailed specifications and precautions before you attempt to use a Relay.
* Refer to pages 218 to 220 for detailed information on models certified for standards.

Product Table

For PCBs				Application																																																																		
G3VM-61H1	G3VM-61HR	G3VM-61HR1	G3VM-62J1	Model																																																																		
1a (SPST-NO)			2a (DPST-NO)	Contact form																																																																		
				Package (Unit : mm, Average)																																																																		
SOP6	SOP6	NEW SOP6	SOP8	Features																																																																		
<ul style="list-style-type: none"> General-purpose Type Load voltage: 60 V 	<ul style="list-style-type: none"> High-current and Low-ON-resistance Type Load voltage: 60 V Continuous load current: 2.3 A (4.6 A) max. * * Values in parentheses are for connection C. 	<ul style="list-style-type: none"> High-current and Low-ON-resistance Type Load voltage: 60 V Continuous load current: 3.3 A (6.6 A) max. * * Values in parentheses are for connection C. 	<ul style="list-style-type: none"> General-purpose Type Load voltage: 60 V 	Isolation method																																																																		
Photodiode coupler				<table border="1"> <thead> <tr> <th rowspan="2">AC peak DC</th> <th rowspan="2">Load voltage</th> </tr> </thead> <tbody> <tr> <td>10,000</td> <td rowspan="14"> Continuous load current AC peak/ DC * 6-pin type connection C: DC </td> </tr> <tr> <td>9,000</td> <td rowspan="14"> Absolute maximum ratings </td> </tr> <tr> <td>8,000</td> <td rowspan="14"> High-dielectric strength Current-limiting Low-output-resistance and low-ON-resistance Small and High-temperature </td> </tr> <tr> <td>7,000</td> <td rowspan="14"> * Connection C 6,600 mA </td> </tr> <tr> <td>6,000</td> <td rowspan="14"> * Connection C 4,600 mA </td> </tr> <tr> <td>5,000</td> <td rowspan="14"> * Connection C 800 mA </td> </tr> <tr> <td>4,000</td> <td rowspan="14"> 400 mA </td> </tr> <tr> <td>3,000</td> <td rowspan="14"> 50 mA </td> </tr> <tr> <td>2,000</td> <td rowspan="14"> 30 mA </td> </tr> <tr> <td>1,000</td> <td rowspan="14"> 50 mA </td> </tr> <tr> <td>900</td> <td rowspan="14"> 1,500 VAC 50/60 Hz for 1 min. -40 to +85°C (with no icing or condensation) </td> </tr> <tr> <td>800</td> <td rowspan="14"> Ambient operating temperature </td> </tr> <tr> <td>700</td> <td rowspan="14"> Connection A: 2 Ω Connection B: 1 Ω Connection C: 0.25 Ω (typical) </td> </tr> <tr> <td>600</td> <td rowspan="14"> Connection A: 0.07 Ω Connection B: 0.04 Ω Connection C: 0.01 Ω (typical) </td> </tr> <tr> <td>500</td> <td rowspan="14"> Connection A: 0.06 Ω Connection B: 0.015 Ω (typical) Connection C: 0.008 Ω (typical) </td> </tr> <tr> <td>400</td> <td rowspan="14"> 2 Ω </td> </tr> <tr> <td>300</td> <td rowspan="14"> Maximum output ON resistance </td> </tr> <tr> <td>200</td> <td rowspan="14"> Maximum OFF leakage current </td> </tr> <tr> <td>100</td> <td rowspan="14"> 1 μA (at 60 VDC) 10 nA (at 60 VDC) 0.02 μA (at 60 VDC) 1 μA (at 60 VDC) </td> </tr> <tr> <td></td> <td rowspan="14"> ● (SOP) </td> </tr> <tr> <td></td> <td rowspan="14"> Surface-mounting terminals </td> </tr> <tr> <td></td> <td rowspan="14"> PCB terminals </td> </tr> <tr> <td></td> <td rowspan="14"> Surface mounting </td> </tr> <tr> <td></td> <td rowspan="14"> Mounting method </td> </tr> <tr> <td></td> <td rowspan="14"> UL </td> </tr> <tr> <td></td> <td rowspan="14"> Applicable standards </td> </tr> <tr> <td></td> <td rowspan="14"> Compliant </td> </tr> <tr> <td></td> <td rowspan="14"> RoHS compliance </td> </tr> <tr> <td></td> <td rowspan="14"> Approx. 0.1 g Approx. 0.13 g Approx. 0.2 g </td> </tr> <tr> <td></td> <td rowspan="14"> Weight </td> </tr> <tr> <td></td> <td rowspan="14"> 88 131 131 104 </td> </tr> <tr> <td></td> <td rowspan="14"> Page </td> </tr> </tbody> </table>	AC peak DC	Load voltage	10,000	Continuous load current AC peak/ DC * 6-pin type connection C: DC	9,000	Absolute maximum ratings	8,000	High-dielectric strength Current-limiting Low-output-resistance and low-ON-resistance Small and High-temperature	7,000	* Connection C 6,600 mA	6,000	* Connection C 4,600 mA	5,000	* Connection C 800 mA	4,000	400 mA	3,000	50 mA	2,000	30 mA	1,000	50 mA	900	1,500 VAC 50/60 Hz for 1 min. -40 to +85°C (with no icing or condensation)	800	Ambient operating temperature	700	Connection A: 2 Ω Connection B: 1 Ω Connection C: 0.25 Ω (typical)	600	Connection A: 0.07 Ω Connection B: 0.04 Ω Connection C: 0.01 Ω (typical)	500	Connection A: 0.06 Ω Connection B: 0.015 Ω (typical) Connection C: 0.008 Ω (typical)	400	2 Ω	300	Maximum output ON resistance	200	Maximum OFF leakage current	100	1 μA (at 60 VDC) 10 nA (at 60 VDC) 0.02 μA (at 60 VDC) 1 μA (at 60 VDC)		● (SOP)		Surface-mounting terminals		PCB terminals		Surface mounting		Mounting method		UL		Applicable standards		Compliant		RoHS compliance		Approx. 0.1 g Approx. 0.13 g Approx. 0.2 g		Weight		88 131 131 104		Page
AC peak DC	Load voltage																																																																					
		10,000	Continuous load current AC peak/ DC * 6-pin type connection C: DC																																																																			
9,000	Absolute maximum ratings																																																																					
8,000		High-dielectric strength Current-limiting Low-output-resistance and low-ON-resistance Small and High-temperature																																																																				
7,000				* Connection C 6,600 mA																																																																		
6,000					* Connection C 4,600 mA																																																																	
5,000						* Connection C 800 mA																																																																
4,000							400 mA																																																															
3,000									50 mA																																																													
2,000											30 mA																																																											
1,000													50 mA																																																									
900															1,500 VAC 50/60 Hz for 1 min. -40 to +85°C (with no icing or condensation)																																																							
800																	Ambient operating temperature																																																					
700								Connection A: 2 Ω Connection B: 1 Ω Connection C: 0.25 Ω (typical)																																																														
600										Connection A: 0.07 Ω Connection B: 0.04 Ω Connection C: 0.01 Ω (typical)																																																												
500			Connection A: 0.06 Ω Connection B: 0.015 Ω (typical) Connection C: 0.008 Ω (typical)																																																																			
400	2 Ω																																																																					
300		Maximum output ON resistance																																																																				
200				Maximum OFF leakage current																																																																		
100					1 μA (at 60 VDC) 10 nA (at 60 VDC) 0.02 μA (at 60 VDC) 1 μA (at 60 VDC)																																																																	
						● (SOP)																																																																
							Surface-mounting terminals																																																															
									PCB terminals																																																													
											Surface mounting																																																											
												Mounting method																																																										
													UL																																																									
														Applicable standards																																																								
								Compliant																																																														
										RoHS compliance																																																												
			Approx. 0.1 g Approx. 0.13 g Approx. 0.2 g																																																																			
	Weight																																																																					
		88 131 131 104																																																																				
				Page																																																																		

* Only basic specifications are given in this table. Refer to the reference page given in the table for detailed specifications and precautions before you attempt to use a Relay.
 * Refer to pages 218 to 220 for detailed information on models certified for standards.

Product Table

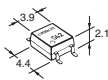
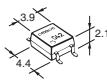
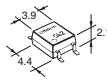
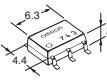
Application		For PCBs			
Model	G3VM-81GR	G3VM-81GR1	G3VM-81G1	G3VM-81HR	
Contact form	1a (SPST-NO)				
Package (Unit : mm, Average)					
	SOP4	SOP4	SOP4	SOP6	
Features	<ul style="list-style-type: none"> Low-output-capacitance and Low-ON-resistance Type (with Low C x R) Load voltage: 80 V 	<ul style="list-style-type: none"> Low-output-capacitance and Low-ON-resistance Type (with Low C x R) Load voltage: 80 V 	<ul style="list-style-type: none"> General-purpose Type Load voltage: 80 V 	<ul style="list-style-type: none"> High-current and Low-ON-resistance Type Load voltage: 80 V Continuous load current: 1.25 A (2.5 A) max. * * Values in parentheses are for connection C. 	
Isolation method	Photodiode coupler				
Absolute maximum ratings	Load voltage	80 V			
	AC peak				
	DC				
	Continuous load current				* Connection C 2.500 mA
	AC peak/ DC				1.250 mA
	* 6-pin type connection C: DC				2.500 mA
	4000				
	3000				
	2000				
	1000				
900					
800					
700					
600					
500					
400					
300					
200					
100	40 mA	200 mA	350 mA		
Input	LED forward current	50 mA			
	Dielectric strength between I/O	1,500 VAC 50/60 Hz for 1 min.			
	Ambient operating temperature	-20 to +85°C (with no icing or condensation)			
Electrical characteristics	Output	Maximum output ON resistance	25 Ω	8 Ω	1.2 Ω
		Maximum OFF leakage current	1 nA (at 80 VDC)		1 nA (at 30 VDC)
Terminal structure	Surface-mounting terminals	● (SOP)			
	PCB terminals				
	Mounting method	Surface mounting			
	Applicable standards	UL			
	RoHS compliance	Compliant			
	Weight	Approx. 0.1 g			
	Page	165	165	73	137

* Only basic specifications are given in this table. Refer to the reference page given in the table for detailed specifications and precautions before you attempt to use a Relay.
* Refer to pages 218 to 220 for detailed information on models certified for standards.

Product Table

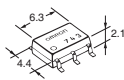
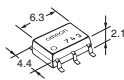
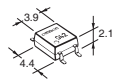
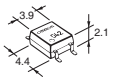
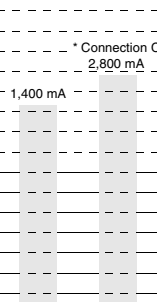
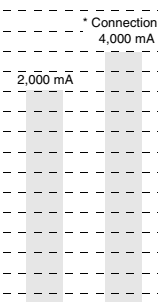
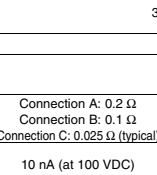
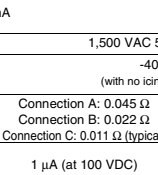
For PCBs				Application
G3VM-101HR	G3VM-101HR1	G3VM-201G	G3VM-201G1	Model
1a (SPST-NO)				Contact form
				Package (Unit : mm, Average)
SOP6	NEW SOP6	SOP4	SOP4	Features
<ul style="list-style-type: none"> High-current and Low-ON-resistance Type Load voltage: 100 V Continuous load current: 1.4 A (2.8 A) max. * * Values in parentheses are for connection C. 	<ul style="list-style-type: none"> High-current and Low-ON-resistance Type Load voltage: 100 V Continuous load current: 2 A (4 A) max. * * Values in parentheses are for connection C. 	<ul style="list-style-type: none"> General-purpose Type Load voltage: 200 V 	<ul style="list-style-type: none"> General-purpose Type Load voltage: 200 V Trigger LED forward current : 1 mA max. 	
Photodiode coupler				Isolation method
100 V		200 V		AC peak DC
 <p>* Connection C 2,800 mA</p>		 <p>* Connection C 4,000 mA</p>		Absolute maximum ratings Output Continuous load current AC peak/ DC * 6-pin type connection C: DC
 <p>1,400 mA</p>		 <p>2,000 mA</p>		
30 mA		50 mA		LED forward current
1,500 VAC 50/60 Hz for 1 min.				Dielectric strength between I/O
-40 to +85°C (with no icing or condensation)				Ambient operating temperature
Connection A: 0.2 Ω Connection B: 0.1 Ω Connection C: 0.025 Ω (typical)	Connection A: 0.045 Ω Connection B: 0.022 Ω Connection C: 0.011 Ω (typical)	50 Ω	8 Ω	Maximum output ON resistance
10 nA (at 100 VDC)	1 μA (at 100 VDC)	1 nA (at 160 VDC)	1 μA (at 200 VDC)	Maximum OFF leakage current
● (SOP)				Surface-mounting terminals
Surface mounting				PCB terminals
UL				Mounting method
Compliant				Applicable standards
Approx. 0.13 g				RoHS compliance
Approx. 0.13 g		Approx. 0.1 g		Weight
137	137	77	77	Page

* Only basic specifications are given in this table. Refer to the reference page given in the table for detailed specifications and precautions before you attempt to use a Relay.
* Refer to pages 218 to 220 for detailed information on models certified for standards.

Product Table

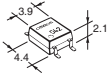
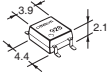
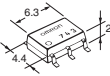
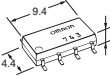
Application		For PCBs						
Model	G3VM-201G2	G3VM-S5	G3VM-201H1	G3VM-201H1				
Contact form	1a (SPST-NO)			2a (DPST-NO)				
Package (Unit : mm, Average)								
	SOP4	SOP4	SOP6	SOP8				
Features	<ul style="list-style-type: none"> General-purpose Type Load voltage: 200 V Trigger LED forward current : 0.2 mA max. 	<ul style="list-style-type: none"> General-purpose Type Load voltage: 200 V 	<ul style="list-style-type: none"> General-purpose Type Load voltage: 200 V 	<ul style="list-style-type: none"> Multi-contact-pair Type Load voltage: 200 V Contact form: 2a (DPST-NO) 				
Isolation method		Photodiode coupler						
Absolute maximum ratings	Output	Load voltage	200 V					
		AC peak DC	200 V					
	Input	Continuous load current AC peak/ DC * 6-pin type connection C: DC	10,000					
			9,000					
			8,000					
			7,000					
			6,000					
			5,000					
			4,000					
			3,000					
2,000								
1,000								
Electrical characteristics	Output	Maximum output ON resistance	8 Ω		Connection A: 8 Ω Connection B: 5 Ω Connection C: 1.5 Ω (typical)			
			Maximum OFF leakage current	1 μA (at 200 VDC)				
				Terminal structure	Surface-mounting terminals ● (SOP)			
					PCB terminals			
				Mounting method		Surface mounting		
				Applicable standards		UL		
				RoHS compliance		Compliant		
				Weight		Approx. 0.13 g		Approx. 0.13 g
				Page		77		88

* Only basic specifications are given in this table. Refer to the reference page given in the table for detailed specifications and precautions before you attempt to use a Relay.
* Refer to pages 218 to 220 for detailed information on models certified for standards.

Product Table

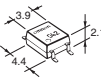
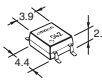
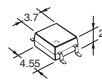
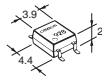
For PCBs				Application
G3VM-351G1	G3VM-351G	G3VM-351VY	G3VM-351GL	Model
1a (SPST-NO)				Contact form
				Package (Unit : mm, Average)
SOP4	SOP4	NEW Special SOP4	SOP4	Features
<ul style="list-style-type: none"> General-purpose Type Load voltage: 350 V Trigger LED forward current : 1 mA max. 	<ul style="list-style-type: none"> General-purpose Type Load voltage: 350 V 	<ul style="list-style-type: none"> General-purpose Type Load voltage: 350 V Dielectric strength between I/O: 3,750 VAC High Ambient operating temperature: -40 to +110°C 	<ul style="list-style-type: none"> Current-limiting Type Load voltage: 350 V Current limit: 150 to 300 mA 	
Photodiode coupler				Isolation method
350 V				AC peak DC Load voltage
				Continuous load current AC peak/ DC * 6-pin type connection C: DC
100 mA	110 mA	110 mA	120 mA	Current limiting (Current limit: 150 to 300 mA)
50 mA		30 mA	50 mA	LED forward current
1,500 VAC 50/60 Hz for 1 min. -40 to +85°C (with no icing or condensation)		3,750 VAC 50/60 Hz for 1 min. -40 to +110°C (with no icing or condensation)	1,500 VAC 50/60 Hz for 1 min. -40 to +85°C (with no icing or condensation)	Dielectric strength between I/O
	50 Ω		35 Ω	Maximum output ON resistance
	1 μA (at 350 VDC)			Maximum OFF leakage current
	● (SOP)			Surface-mounting terminals
	Surface mounting			PCB terminals
	UL		---	Mounting method
	Compliant			Applicable standards
	Approx. 0.1 g		Approx. 0.03 g	RoHS compliance
	82	82	159	Weight
				Page

* Only basic specifications are given in this table. Refer to the reference page given in the table for detailed specifications and precautions before you attempt to use a Relay.
* Refer to pages 218 to 220 for detailed information on models certified for standards.

Product Table

Application		For PCBs			
Model	G3VM-353G	G3VM-351H	G3VM-353H	G3VM-355JR	
Contact form	1b (SPST-NC)	1a (SPST-NO)	1b (SPST-NC)	1a1b (SPST-NO/SPST-NC)	
Package (Unit : mm, Average)					
Features	<ul style="list-style-type: none"> General-purpose Type Load voltage: 350 V Contact form: 1b (SPST-NC) 	<ul style="list-style-type: none"> General-purpose Type Load voltage: 350 V 	<ul style="list-style-type: none"> General-purpose Type Load voltage: 350 V Contact form: 1b (SPST-NC) 	<ul style="list-style-type: none"> Multi-contact-pair Type Load voltage: 350 V Contact form: 1a1b (SPST-NO/SPST-NC) 	
Isolation method		Photodiode coupler			
Absolute maximum ratings	Output	Load voltage	350 V		
		AC peak DC	350 V		
	Continuous load current AC peak/DC * 6-pin type connection C: DC	10,000			
		9,000			
		8,000			
		7,000			
		6,000			
		5,000			
		4,000			
		3,000			
2,000					
1,000					
900					
800					
700					
600					
500					
400					
300					
200	120 mA	110 mA	120 mA	120 mA	
100					
Input	LED forward current				
Dielectric strength between I/O		1,500 VAC 50/60 Hz for 1 min.			
Ambient operating temperature		-40 to +85°C (with no icing or condensation)			
Electrical characteristics	Output	Maximum output ON resistance	25 Ω Connection A: 50 Ω Connection B: 40 Ω Connection C: 20 Ω	Connection A: 25 Ω Connection B: 14 Ω Connection C: 4 Ω (typical)	25 Ω
	Output	Maximum OFF leakage current	1 μA (at 350 VDC)		
Terminal structure	Surface-mounting terminals		● (SOP)		
	PCB terminals				
Mounting method		Surface mounting			
Applicable standards		UL			
RoHS compliance		Compliant			
Weight		Approx. 0.1 g	Approx. 0.13 g		Approx. 0.2 g
Page		82	88	88	104

* Only basic specifications are given in this table. Refer to the reference page given in the table for detailed specifications and precautions before you attempt to use a Relay.
 * Refer to pages 218 to 220 for detailed information on models certified for standards.

Product Table

For PCBs				Application
G3VM-352J	G3VM-354J	G3VM-401G1	G3VM-401G	Model
2a (DPST-NO)	2b (DPST-NC)	1a (SPST-NO)		Contact form
				Package (Unit : mm, Average)
SOP8	SOP8	SOP4	SOP4	Features
<ul style="list-style-type: none"> Multi-contact-pair Type Load voltage: 350 V Contact form: 2a (DPST-NO) 	<ul style="list-style-type: none"> Multi-contact-pair Type Load voltage: 350 V Contact form: 2b (DPST-NC) 	<ul style="list-style-type: none"> General-purpose Type Load voltage: 400 V Trigger LED forward current : 0.2 mA max. 	<ul style="list-style-type: none"> General-purpose Type Load voltage: 400 V 	Features
Photodiode coupler				Isolation method
350 V		400 V		AC peak DC
				Load voltage
				Continuous load current AC peak/ DC * 6-pin type connection C: DC
110 mA		120 mA		
50 mA		30 mA		
		50 mA		LED forward current
1,500 VAC 50/60 Hz for 1 min.				Dielectric strength between I/O
-40 to +85°C (with no icing or condensation)				Ambient operating temperature
50 Ω	25 Ω	35 Ω		Maximum output ON resistance
1 μA (at 350 VDC)		1 μA (at 400 VDC)		Maximum OFF leakage current
● (SOP)				Surface-mounting terminals
				PCB terminals
Surface mounting				Mounting method
UL		UL certification is pending	UL and BSI (EN 60950)	Applicable standards
Compliant				RoHS compliance
Approx. 0.2 g		Approx. 0.1 g		Weight
104	104	82	82	Page

* Only basic specifications are given in this table. Refer to the reference page given in the table for detailed specifications and precautions before you attempt to use a Relay.
* Refer to pages 218 to 220 for detailed information on models certified for standards.

Product Table

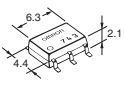
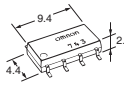
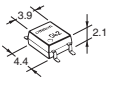
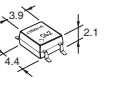
Application		For PCBs					
Model	G3VM-401H	G3VM-402J	G3VM-601G1	G3VM-601G			
Contact form	1a (SPST-NO)	2a (DPST-NO)	1a (SPST-NO)				
Package (Unit : mm, Average)							
	SOP6	SOP8	SOP4	SOP4			
Features	<ul style="list-style-type: none"> General-purpose Type Load voltage: 400 V 	<ul style="list-style-type: none"> Multi-contact-pair Type Load voltage: 400 V Contact form: 2a (DPST-NO) 	<ul style="list-style-type: none"> General-purpose Type Load voltage: 600 V Trigger LED forward current : 0.2 mA max. 	<ul style="list-style-type: none"> General-purpose Type Load voltage: 600 V 			
Isolation method		Photodiode coupler					
Absolute maximum ratings	Load voltage	AC peak	400 V		600 V		
		DC					
	Output	Continuous load current AC peak/ DC * 6-pin type connection C: DC	10,000	-----	-----	-----	-----
			9,000	-----	-----	-----	-----
			8,000	-----	-----	-----	-----
			7,000	-----	-----	-----	-----
			6,000	-----	-----	-----	-----
			5,000	-----	-----	-----	-----
			4,000	-----	-----	-----	-----
			3,000	-----	-----	-----	-----
2,000			-----	-----	-----	-----	
1,000			-----	-----	-----	-----	
Input	LED forward current	120 mA	-----	-----	-----	-----	
		100	-----	-----	-----	-----	
		90	-----	-----	-----	-----	
		80	-----	-----	-----	-----	
		70	-----	-----	-----	-----	
		60	-----	-----	-----	-----	
		50	-----	-----	-----	-----	
		40	-----	-----	-----	-----	
		300	-----	-----	-----	-----	
		240	-----	-----	-----	-----	
Dielectric strength between I/O		1,500 VAC 50/60 Hz for 1 min.					
Ambient operating temperature		-40 to +85°C (with no icing or condensation)					
Electrical characteristics	Output	Maximum output ON resistance	Connection A: 35 Ω Connection B: 20 Ω Connection C: 6 Ω (typical)	35 Ω	60 Ω		
		Maximum OFF leakage current	1 μA (at 400 VDC)		1 μA (at 600 VDC)		
Terminal structure	Surface-mounting terminals	● (SOP)					
	PCB terminals						
Mounting method		Surface mounting					
Applicable standards		UL and BSI (EN 60950)		UL			
RoHS compliance		Compliant					
Weight		Approx. 0.13 g	Approx. 0.2 g	Approx. 0.1 g			
Page		88	104	94	94		

* Only basic specifications are given in this table. Refer to the reference page given in the table for detailed specifications and precautions before you attempt to use a Relay.
* Refer to pages 218 to 220 for detailed information on models certified for standards.

Product Table

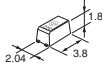
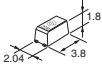
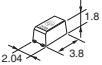
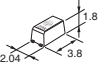
For PCBs				Application																																					
G3VM-21LR	G3VM-21LR10	G3VM-21LR1	G3VM-21LR11	Model																																					
1a (SPST-NO)				Contact form																																					
				Package (Unit : mm, Average)																																					
SSOP4	SSOP4	SSOP4	SSOP4	Features																																					
<ul style="list-style-type: none"> Low-output-capacitance and Low-ON-resistance Type (with Low C × R) Load voltage: 20 V Low C × R = 5 pF · Ω C_{OFF} (typical) = 1 pF 	<ul style="list-style-type: none"> Low-output-capacitance and Low-ON-resistance Type (with Low C × R) Load voltage: 20 V Low C × R = 2.4 pF · Ω C_{OFF} (typical) = 0.8 pF 	<ul style="list-style-type: none"> Low-output-capacitance and Low-ON-resistance Type (with Low C × R) Load voltage: 20 V Low C × R = 4 pF · Ω R_{ON} (typical) = 0.8 Ω 	<ul style="list-style-type: none"> Low-output-capacitance and Low-ON-resistance Type (with Low C × R) Load voltage: 20 V Low C × R = 7.2 pF · Ω R_{ON} (typical) = 0.18 Ω 																																						
Photodiode coupler				Isolation method																																					
20 V				<table border="1"> <thead> <tr> <th>AC peak DC</th> <th>Load voltage</th> </tr> </thead> <tbody> <tr> <td colspan="2">Continuous load current AC peak/ DC * 6-pin type connection C: DC</td> </tr> <tr> <td>10,000</td> <td rowspan="16"> <table border="1"> <thead> <tr> <th>Output</th> </tr> </thead> <tbody> <tr><td>9,000</td></tr> <tr><td>8,000</td></tr> <tr><td>7,000</td></tr> <tr><td>6,000</td></tr> <tr><td>5,000</td></tr> <tr><td>4,000</td></tr> <tr><td>3,000</td></tr> <tr><td>2,000</td></tr> <tr><td>1,000</td></tr> <tr><td>900</td></tr> <tr><td>800</td></tr> <tr><td>700</td></tr> <tr><td>600</td></tr> <tr><td>500</td></tr> <tr><td>400</td></tr> <tr><td>300</td></tr> <tr><td>200</td></tr> <tr><td>100</td></tr> </tbody> </table> </td> </tr> <tr> <td>160 mA</td> <td>200 mA</td> </tr> <tr> <td>50 mA</td> <td>30 mA</td> </tr> <tr> <td></td> <td>450 mA</td> </tr> <tr> <td></td> <td>900 mA</td> </tr> <tr> <td></td> <td>50 mA</td> </tr> <tr> <td colspan="2">LED forward current</td> </tr> </tbody> </table>	AC peak DC	Load voltage	Continuous load current AC peak/ DC * 6-pin type connection C: DC		10,000	<table border="1"> <thead> <tr> <th>Output</th> </tr> </thead> <tbody> <tr><td>9,000</td></tr> <tr><td>8,000</td></tr> <tr><td>7,000</td></tr> <tr><td>6,000</td></tr> <tr><td>5,000</td></tr> <tr><td>4,000</td></tr> <tr><td>3,000</td></tr> <tr><td>2,000</td></tr> <tr><td>1,000</td></tr> <tr><td>900</td></tr> <tr><td>800</td></tr> <tr><td>700</td></tr> <tr><td>600</td></tr> <tr><td>500</td></tr> <tr><td>400</td></tr> <tr><td>300</td></tr> <tr><td>200</td></tr> <tr><td>100</td></tr> </tbody> </table>	Output	9,000	8,000	7,000	6,000	5,000	4,000	3,000	2,000	1,000	900	800	700	600	500	400	300	200	100	160 mA	200 mA	50 mA	30 mA		450 mA		900 mA		50 mA	LED forward current	
AC peak DC	Load voltage																																								
Continuous load current AC peak/ DC * 6-pin type connection C: DC																																									
10,000	<table border="1"> <thead> <tr> <th>Output</th> </tr> </thead> <tbody> <tr><td>9,000</td></tr> <tr><td>8,000</td></tr> <tr><td>7,000</td></tr> <tr><td>6,000</td></tr> <tr><td>5,000</td></tr> <tr><td>4,000</td></tr> <tr><td>3,000</td></tr> <tr><td>2,000</td></tr> <tr><td>1,000</td></tr> <tr><td>900</td></tr> <tr><td>800</td></tr> <tr><td>700</td></tr> <tr><td>600</td></tr> <tr><td>500</td></tr> <tr><td>400</td></tr> <tr><td>300</td></tr> <tr><td>200</td></tr> <tr><td>100</td></tr> </tbody> </table>	Output	9,000	8,000	7,000	6,000	5,000	4,000	3,000		2,000	1,000	900	800	700	600	500	400	300	200	100																				
Output																																									
9,000																																									
8,000																																									
7,000																																									
6,000																																									
5,000																																									
4,000																																									
3,000																																									
2,000																																									
1,000																																									
900																																									
800																																									
700																																									
600																																									
500																																									
400																																									
300																																									
200																																									
100																																									
160 mA	200 mA																																								
50 mA	30 mA																																								
	450 mA																																								
	900 mA																																								
	50 mA																																								
LED forward current																																									
1,500 VAC 50/60 Hz for 1 min.				Dielectric strength between I/O																																					
-20 to +85°C (with no icing or condensation)				Ambient operating temperature																																					
8 Ω	5 Ω	1.2 Ω	0.22 Ω	Maximum output ON resistance																																					
1 nA (at 20 VDC)	0.2 nA (at 20 VDC)	1 nA (at 20 VDC)		Maximum OFF leakage current																																					
● (SSOP)				Surface-mounting terminals																																					
Surface mounting				PCB terminals																																					
UL				Mounting method																																					
Compliant				Applicable standards																																					
Approx. 0.03 g				RoHS compliance																																					
				Weight																																					
170	170	170	170	Page																																					

* Only basic specifications are given in this table. Refer to the reference page given in the table for detailed specifications and precautions before you attempt to use a Relay.
* Refer to pages 218 to 220 for detailed information on models certified for standards.

Product Table

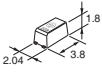
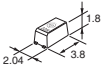
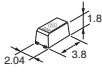
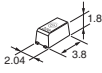
Application		For PCBs				
Model	G3VM-41LR10	G3VM-41LR6	G3VM-41LR11	G3VM-41LR4		
Contact form		1a (SPST-NO)				
Package (Unit : mm, Average)						
Features	<ul style="list-style-type: none"> Low-output-capacitance and Low-ON-resistance Type (with Low C × R) Load voltage: 40 V Low C × R = 5.4 pF · Ω C_{OFF} (typical) = 0.45 pF 	<ul style="list-style-type: none"> Low-output-capacitance and Low-ON-resistance Type (with Low C × R) Load voltage: 40 V Low C × R = 10 pF · Ω C_{OFF} (typical) = 1 pF 	<ul style="list-style-type: none"> Low-output-capacitance and Low-ON-resistance Type (with Low C × R) Load voltage: 40 V Low C × R = 4.9 pF · Ω C_{OFF} (typical) = 0.7 pF 	<ul style="list-style-type: none"> Low-output-capacitance and Low-ON-resistance Type (with Low C × R) Load voltage: 40 V Low C × R = 10 pF · Ω R_{ON} (typical) = 2 Ω 		
Isolation method		Photodiode coupler				
Absolute maximum ratings	Load voltage	40 V				
		AC peak				
	Output	DC	10,000	9,000	8,000	7,000
		9,000				
		8,000				
		7,000				
		6,000				
		5,000				
		4,000				
		3,000				
2,000						
1,000						
Continuous load current						
AC peak/ DC						
* 6-pin type connection C: DC						
900						
800						
700						
600						
500						
400						
300						
200	120 mA	120 mA	140 mA	250 mA		
100						
Input	LED forward current	30 mA	50 mA	30 mA	50 mA	
Dielectric strength between I/O		1,500 VAC 50/60 Hz for 1 min.				
Ambient operating temperature		-20 to +85°C (with no icing or condensation)				
Electrical characteristics	Output	Maximum output ON resistance	14 Ω	15 Ω	10 Ω	3 Ω
		Maximum OFF leakage current	0.2 nA (at 35 VDC)	1 nA (at 30 VDC)	0.2 nA (at 35 VDC)	1 nA (at 30 VDC)
Terminal structure	Surface-mounting terminals	● (SSOP)				
	PCB terminals					
Mounting method		Surface mounting				
Applicable standards		UL				
RoHS compliance		Compliant				
Weight		Approx. 0.03 g				
Page		175	175	175	175	

* Only basic specifications are given in this table. Refer to the reference page given in the table for detailed specifications and precautions before you attempt to use a Relay.
* Refer to pages 218 to 220 for detailed information on models certified for standards.

Product Table

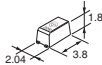
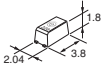
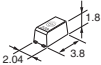
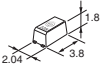
For PCBs					Application
G3VM-41LR5	G3VM-61LR	G3VM-81LR	G3VM-101LR	Model	
1a (SPST-NO)					Contact form
				Package (Unit : mm, Average)	
SSOP4	SSOP4	SSOP4	SSOP4	Features	
<ul style="list-style-type: none"> • Low-output-capacitance and Low-ON-resistance Type (with Low C x R) • Load voltage: 40 V • Low C x R = 10 pF · Ω • R_{ON} (typical) = 1 Ω 	<ul style="list-style-type: none"> • Small and High-load-voltage Type • Load voltage: 60 V • R_{ON} (typical) = 1 Ω 	<ul style="list-style-type: none"> • Small and High-load-voltage Type • Load voltage: 80 V 	<ul style="list-style-type: none"> • Small and High-load-voltage Type • Load voltage: 100 V 		
Photodiode coupler					Isolation method
40 V	60 V	80 V	100 V	AC peak DC	Load voltage
					Continuous load current AC peak/ DC * 6-pin type connection C: DC
					Output
					Input
					LED forward current
					Dielectric strength between I/O
					Ambient operating temperature
					Maximum output ON resistance
					Maximum OFF leakage current
					Electrical characteristics
					PCB terminals
					Mounting method
					Applicable standards
					RoHS compliance
					Weight
					Page

* Only basic specifications are given in this table. Refer to the reference page given in the table for detailed specifications and precautions before you attempt to use a Relay.
* Refer to pages 218 to 220 for detailed information on models certified for standards.

Product Table

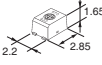
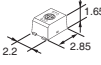
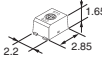
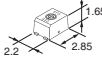
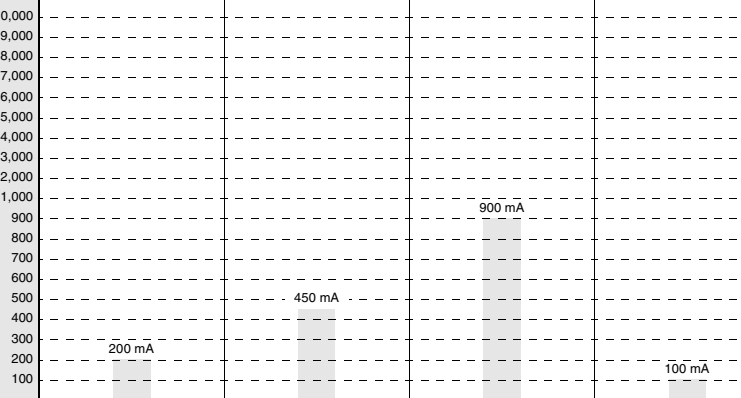
Application		For PCBs				
Model	G3VM-21PR10	G3VM-21PR1	G3VM-21PR11	G3VM-41PR12		
Contact form		1a (SPST-NO)				
Package (Unit : mm, Average)						
Features		<ul style="list-style-type: none"> Low-output-capacitance and Low-ON-resistance Type (with Low C × R) Load voltage: 20 V Low C × R = 2.4 pF · Ω C_{OFF} (typical) = 0.8 pF 	<ul style="list-style-type: none"> Low-output-capacitance and Low-ON-resistance Type (with Low C × R) Load voltage: 20 V Low C × R = 3 pF · Ω R_{ON} (typical) = 0.6 Ω 	<ul style="list-style-type: none"> Low-output-capacitance and Low-ON-resistance Type (with Low C × R) Load voltage: 20 V Low C × R = 7.2 pF · Ω R_{ON} (typical) = 0.18 Ω 	<ul style="list-style-type: none"> Low-output-capacitance and Low-ON-resistance Type (with Low C × R) Load voltage: 40 V Low C × R = 4.5 pF · Ω C_{OFF} (typical) = 0.3 pF 	
Isolation method		Photodiode coupler				
Load voltage		20 V		40 V		
AC peak DC						
Output						
Input		LED forward current 50 mA				
Dielectric strength between I/O		500 VAC 50/60 Hz for 1 min.				
Ambient operating temperature		-40 to +85°C (with no icing or condensation)				
Electrical characteristics						
Output		Maximum output ON resistance	5 Ω	1.2 Ω	0.22 Ω	20 Ω
		Maximum OFF leakage current	1 nA (at 20 VDC)		1 nA (at 40 VDC)	
Terminal structure		Surface-mounting terminals ● (USOP)				
		PCB terminals				
Mounting method		Surface mounting				
Applicable standards		UL				
RoHS compliance		Compliant				
Weight		Approx. 0.03 g				
Page		180	180	180	185	

* Only basic specifications are given in this table. Refer to the reference page given in the table for detailed specifications and precautions before you attempt to use a Relay.
 * Refer to pages 218 to 220 for detailed information on models certified for standards.

Product Table

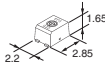
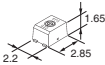
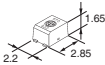
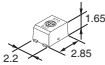
For PCBs					Application	
G3VM-41PR10	G3VM-41PR6	G3VM-41PR11	G3VM-41PR5	Model		
1a (SPST-NO)					Contact form	
				Package (Unit : mm, Average)		
USOP4	USOP4	USOP4	USOP4	Features		
<ul style="list-style-type: none"> Low-output-capacitance and Low-ON-resistance Type (with Low C × R) Load voltage: 40 V Low C × R = 5.4 pF · Ω C_{OFF} (typical) = 0.45 pF 	<ul style="list-style-type: none"> Low-output-capacitance and Low-ON-resistance Type (with Low C × R) Load voltage: 40 V Low C × R = 4 pF · Ω R_{ON} (typical) = 0.8 Ω 	<ul style="list-style-type: none"> Low-output-capacitance and Low-ON-resistance Type (with Low C × R) Load voltage: 40 V Low C × R = 4.9 pF · Ω C_{OFF} (typical) = 0.7 pF 	<ul style="list-style-type: none"> Low-output-capacitance and Low-ON-resistance Type (with Low C × R) Load voltage: 40 V Low C × R = 10 pF · Ω R_{ON} (typical) = 1 Ω 	Isolation method		
Photodiode coupler					AC peak DC	Load voltage
40 V					Continuous load current AC peak/ DC * 6-pin type connection C: DC	
					10,000	Absolute maximum ratings
					9,000	
					8,000	
					7,000	
					6,000	
					5,000	
					4,000	
					3,000	
					2,000	
					1,000	
					900	
					800	
					700	
					600	
					500	
					400	
					300	
					200	
					100	
					300 mA	
					120 mA	
					120 mA	
					140 mA	
					50 mA	
500 VAC 50/60 Hz for 1 min.					LED forward current	
-40 to +85°C (with no icing or condensation)					Dielectric strength between I/O	
					Ambient operating temperature	
					Maximum output ON resistance	
					Maximum OFF leakage current	
					Surface-mounting terminals	
					PCB terminals	
					Mounting method	
					Applicable standards	
					RoHS compliance	
					Weight	
					Page	
185	185	185	185			



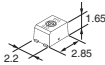
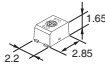

* Only basic specifications are given in this table. Refer to the reference page given in the table for detailed specifications and precautions before you attempt to use a Relay.
* Refer to pages 218 to 220 for detailed information on models certified for standards.

Product Table

Application		For PCBs																																																																																																							
Model	G3VM-51PR	G3VM-61PR1	G3VM-61PR																																																																																																						
Contact form	1a (SPST-NO)																																																																																																								
Package (Unit : mm, Average)																																																																																																									
	USOP4	USOP4	USOP4																																																																																																						
Features	<ul style="list-style-type: none"> • Low-output-capacitance and Low-ON-resistance Type (with Low C x R) • Load voltage: 50 V • Low C x R = 12 pF · Ω • Ron (typical) = 1 Ω 	<ul style="list-style-type: none"> • Small and High-load-voltage Type • Load voltage: 60 V • Low C x R = 7 pF · Ω • Coff (typical) = 0.7 pF 	<ul style="list-style-type: none"> • Small and High-load-voltage Type • Load voltage: 60 V 																																																																																																						
Isolation method		Photodiode coupler																																																																																																							
Absolute maximum ratings Output	<table border="1"> <thead> <tr> <th>Load voltage</th> <th>AC peak DC</th> <th>50 V</th> <th colspan="2">60 V</th> </tr> </thead> <tbody> <tr><td>10,000</td><td></td><td></td><td></td><td></td></tr> <tr><td>9,000</td><td></td><td></td><td></td><td></td></tr> <tr><td>8,000</td><td></td><td></td><td></td><td></td></tr> <tr><td>7,000</td><td></td><td></td><td></td><td></td></tr> <tr><td>6,000</td><td></td><td></td><td></td><td></td></tr> <tr><td>5,000</td><td></td><td></td><td></td><td></td></tr> <tr><td>4,000</td><td></td><td></td><td></td><td></td></tr> <tr><td>3,000</td><td></td><td></td><td></td><td></td></tr> <tr><td>2,000</td><td></td><td></td><td></td><td></td></tr> <tr><td>1,000</td><td></td><td></td><td></td><td></td></tr> <tr><td>900</td><td></td><td></td><td></td><td></td></tr> <tr><td>800</td><td></td><td></td><td></td><td></td></tr> <tr><td>700</td><td></td><td></td><td></td><td></td></tr> <tr><td>600</td><td></td><td></td><td></td><td></td></tr> <tr><td>500</td><td></td><td></td><td></td><td></td></tr> <tr><td>400</td><td></td><td></td><td></td><td></td></tr> <tr><td>300</td><td></td><td>300 mA</td><td></td><td>400 mA</td></tr> <tr><td>200</td><td></td><td></td><td>120 mA</td><td></td></tr> <tr><td>100</td><td></td><td></td><td></td><td></td></tr> </tbody> </table>	Load voltage	AC peak DC	50 V	60 V		10,000					9,000					8,000					7,000					6,000					5,000					4,000					3,000					2,000					1,000					900					800					700					600					500					400					300		300 mA		400 mA	200			120 mA		100								
	Load voltage	AC peak DC	50 V	60 V																																																																																																					
	10,000																																																																																																								
	9,000																																																																																																								
	8,000																																																																																																								
	7,000																																																																																																								
	6,000																																																																																																								
	5,000																																																																																																								
	4,000																																																																																																								
	3,000																																																																																																								
2,000																																																																																																									
1,000																																																																																																									
900																																																																																																									
800																																																																																																									
700																																																																																																									
600																																																																																																									
500																																																																																																									
400																																																																																																									
300		300 mA		400 mA																																																																																																					
200			120 mA																																																																																																						
100																																																																																																									
<table border="1"> <thead> <tr> <th>LED forward current</th> <th colspan="4">50 mA</th> </tr> </thead> <tbody> <tr> <td>Input</td> <td colspan="4"></td> </tr> </tbody> </table>	LED forward current	50 mA				Input																																																																																																			
LED forward current	50 mA																																																																																																								
Input																																																																																																									
<table border="1"> <thead> <tr> <th>Dielectric strength between I/O</th> <th colspan="4">500 VAC 50/60 Hz for 1 min.</th> </tr> </thead> <tbody> <tr> <td>Ambient operating temperature</td> <td colspan="4">-40 to +85°C (with no icing or condensation)</td> </tr> </tbody> </table>	Dielectric strength between I/O	500 VAC 50/60 Hz for 1 min.				Ambient operating temperature	-40 to +85°C (with no icing or condensation)																																																																																																		
Dielectric strength between I/O	500 VAC 50/60 Hz for 1 min.																																																																																																								
Ambient operating temperature	-40 to +85°C (with no icing or condensation)																																																																																																								
Electrical characteristics Output	<table border="1"> <thead> <tr> <th>Maximum output ON resistance</th> <th>1.5 Ω</th> <th>15 Ω</th> <th colspan="2">1.5 Ω</th> </tr> </thead> <tbody> <tr> <th>Maximum OFF leakage current</th> <td colspan="2">1 nA (at 50 VDC)</td> <td colspan="2">1 nA (at 60 VDC)</td> </tr> </tbody> </table>	Maximum output ON resistance	1.5 Ω	15 Ω	1.5 Ω		Maximum OFF leakage current	1 nA (at 50 VDC)		1 nA (at 60 VDC)																																																																																															
	Maximum output ON resistance	1.5 Ω	15 Ω	1.5 Ω																																																																																																					
Maximum OFF leakage current	1 nA (at 50 VDC)		1 nA (at 60 VDC)																																																																																																						
Terminal structure	Surface-mounting terminals	● (USOP)																																																																																																							
	PCB terminals																																																																																																								
Mounting method		Surface mounting																																																																																																							
Applicable standards		UL																																																																																																							
RoHS compliance		Compliant																																																																																																							
Weight		Approx. 0.03 g																																																																																																							
Page		185	208	208																																																																																																					

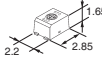
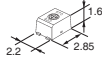
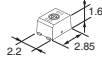



* Only basic specifications are given in this table. Refer to the reference page given in the table for detailed specifications and precautions before you attempt to use a Relay.
 * Refer to pages 218 to 220 for detailed information on models certified for standards.

Product Table

For PCBs			Application
G3VM-71PR	G3VM-81PR	G3VM-101PR	Model
1a (SPST-NO)			Contact form
			Package (Unit : mm, Average)
USOP4	USOP4	USOP4	Features
<ul style="list-style-type: none"> Small and High-load-voltage Type Load voltage: 75 V 	<ul style="list-style-type: none"> Small and High-load-voltage Type Load voltage: 80 V Maximum OFF leakage current : 0.02 nA 	<ul style="list-style-type: none"> Small and High-load-voltage Type Load voltage: 100 V 	
Photodiode coupler			Isolation method
75 V	80 V	100 V	AC peak DC
			Load voltage
			Continuous load current AC peak/ DC * 6-pin type connection C: DC
			
	50 mA		LED forward current
500 VAC 50/60 Hz for 1 min.			Input
-40 to +85°C (with no icing or condensation)			Dielectric strength between I/O
1.5 Ω	12 Ω	14 Ω	Ambient operating temperature
1 nA (at 75 VDC)	0.02 nA (at 80 VDC)	0.2 nA (at 100 VDC)	Maximum output ON resistance
			Maximum OFF leakage current
● (USOP)			Electrical characteristics
			Surface-mounting terminals
Surface mounting			Terminal structure
			PCB terminals
UL			Mounting method
Compliant			Applicable standards
Approx. 0.03 g			RoHS compliance
			Weight
208	208	208	Page





* Only basic specifications are given in this table. Refer to the reference page given in the table for detailed specifications and precautions before you attempt to use a Relay.
 * Refer to pages 218 to 220 for detailed information on models certified for standards.

Product Table

Application		For PCBs				
Model	G3VM-21UR10	G3VM-21UR1	G3VM-21UR11	G3VM-41UR12		
Contact form		1a (SPST-NO)				
Package (Unit : mm, Average)						
Features	<ul style="list-style-type: none"> Low-output-capacitance and Low-ON-resistance Type (with Low C × R) Load voltage: 20 V Low C × R = 2.4 pF · Ω C_{OFF} (typical) = 0.8 pF 	<ul style="list-style-type: none"> Low-output-capacitance and Low-ON-resistance Type (with Low C × R) Load voltage: 20 V Low C × R = 4 pF · Ω R_{ON} (typical) = 0.8 Ω 	<ul style="list-style-type: none"> Low-output-capacitance and Low-ON-resistance Type (with Low C × R) Load voltage: 20 V Low C × R = 7.2 pF · Ω R_{ON} (typical) = 0.18 Ω 	<ul style="list-style-type: none"> Low-output-capacitance and Low-ON-resistance Type (with Low C × R) Load voltage: 40 V Low C × R = 4.5 pF · Ω C_{OFF} (typical) = 0.3 pF 		
Isolation method		Photodiode coupler				
Absolute maximum ratings	Load voltage	AC peak		20 V	40 V	
		DC				
	Output	Continuous load current AC peak/ DC * 6-pin type connection C: DC	10,000			
			9,000			
			8,000			
			7,000			
			6,000			
			5,000			
			4,000			
			3,000			
2,000						
1,000				1,000 mA		
900						
800						
700						
600						
500						
400						
300						
200	200 mA					
100		450 mA		100 mA		
Input	LED forward current	30 mA				
Dielectric strength between I/O		300 VAC 50/60 Hz for 1 min.				
Ambient operating temperature		-40 to +85°C (with no icing or condensation)				
Electrical characteristics	Output	Maximum output ON resistance	5 Ω	1.2 Ω	0.22 Ω	20 Ω
		Maximum OFF leakage current	1 nA (at 20 VDC)			1 nA (at 40 VDC)
Terminal structure	Surface-mounting terminals	● (VSON)				
	PCB terminals					
Mounting method		Surface mounting				
Applicable standards		UL certification is pending				
RoHS compliance		Compliant				
Weight		Approx. 0.01 g				
Page		190	190	190	195	

* Only basic specifications are given in this table. Refer to the reference page given in the table for detailed specifications and precautions before you attempt to use a Relay.
* Refer to pages 218 to 220 for detailed information on models certified for standards.





Product Table

For PCBs					Application
G3VM-41UR10	G3VM-41UR11	G3VM-51UR	G3VM-61UR1	Model	
1a (SPST-NO)					Contact form
				Package (Unit : mm, Average)	
VSON4	VSON4	VSON4	VSON4	Features	
<ul style="list-style-type: none"> Low-output-capacitance and Low-ON-resistance Type (with Low C × R) Load voltage: 40 V Low C × R = 5.4 pF · Ω C_{OFF} (typical) = 0.45 pF 	<ul style="list-style-type: none"> Low-output-capacitance and Low-ON-resistance Type (with Low C × R) Load voltage: 40 V Low C × R = 4.9 pF · Ω C_{OFF} (typical) = 0.7 pF 	<ul style="list-style-type: none"> Low-output-capacitance and Low-ON-resistance Type (with Low C × R) Load voltage: 50 V Low C × R = 12 pF · Ω R_{ON} (typical) = 1 Ω 	<ul style="list-style-type: none"> Low-output-capacitance and Low-ON-resistance Type (with Low C × R) Load voltage: 60 V Low C × R = 7 pF · Ω C_{OFF} (typical) = 0.7 pF 	Isolation method	
Photodiode coupler				AC peak DC	Load voltage
40 V		50 V		60 V	
120 mA		140 mA		120 mA	
		300 mA			
30 mA				LED forward current	
300 VAC 50/60 Hz for 1 min.				Dielectric strength between I/O	
-40 to +85°C (with no icing or condensation)				Ambient operating temperature	
14 Ω	10 Ω	1.5 Ω	15 Ω	Maximum output ON resistance	
1 nA (at 40 VDC)		1 nA (at 50 VDC)		Maximum OFF leakage current	
● (VSON)				Surface-mounting terminals	
				PCB terminals	
Surface mounting				Mounting method	
UL certification is pending				Applicable standards	
Compliant				RoHS compliance	
Approx. 0.01 g				Weight	
195	195	195	213	Page	

* Only basic specifications are given in this table. Refer to the reference page given in the table for detailed specifications and precautions before you attempt to use a Relay.
 * Refer to pages 218 to 220 for detailed information on models certified for standards.







Introduction
General-purpose
High-voltage-type
Multi-contact pair
High-current and Low-ON-resistance
Small and high-
High-dielectric strength
Current-limiting
Low-output-resistance
Small and High-voltage
Certified models with
DIP
SOP
SSOP
USOP
VSON
S-VSON
Product Table

Product Table

Application		For PCBs			
Model	G3VM-61UR	G3VM-81UR	G3VM-81UR1	G3VM-101UR	
Contact form		1a (SPST-NO)			
Package (Unit : mm, Average)					
Features	<ul style="list-style-type: none"> Small and High-load-voltage Type Load voltage: 60 V R_{ON} (typical) =1 Ω 	<ul style="list-style-type: none"> Small and High-load-voltage Type Load voltage: 80 V Maximum OFF leakage current: 0.02 nA 	<ul style="list-style-type: none"> Small and High-load-voltage Type Load voltage: 80 V 	<ul style="list-style-type: none"> Small and High-load-voltage Type Load voltage: 100 V 	
Isolation method		Photodiode coupler			
Load voltage		60 V	80 V	100 V	
AC peak DC					
Output					
Continuous load current					
AC peak/ DC					
* 6-pin type connection C: DC					
10,000					
9,000					
8,000					
7,000					
6,000					
5,000					
4,000					
3,000					
2,000					
1,000					
900					
800					
700					
600					
500					
400		400 mA			
300					
200					
100			120 mA	200 mA	
100 mA					
Input	LED forward current	30 mA			
Dielectric strength between I/O		300 VAC 50/60 Hz for 1 min.			
Ambient operating temperature		-40 to +85°C (with no icing or condensation)			
Electrical characteristics	Output				
Maximum output ON resistance		1.5 Ω	12 Ω	8 Ω	14 Ω
Maximum OFF leakage current		1 nA (at 60 VDC)	0.02 nA (at 80 VDC)	1 nA (at 80 VDC)	0.2 nA (at 100 VDC)
Terminal structure	Surface-mounting terminals	● (VSON)			
PCB terminals					
Mounting method		Surface mounting			
Applicable standards		UL certification is pending			
RoHS compliance		Compliant			
Weight		Approx. 0.01 g			
Page		213	213	213	213

* Only basic specifications are given in this table. Refer to the reference page given in the table for detailed specifications and precautions before you attempt to use a Relay.
* Refer to pages 218 to 220 for detailed information on models certified for standards.

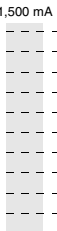
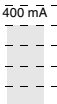
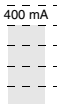
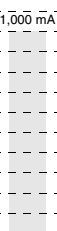
Product Table

For PCBs					Application																								
G3VM-31QR	G3VM-41QR10	G3VM-61QR	G3VM-61QR2	G3VM-101QR1	Model																								
1a (SPST-NO)					Contact form																								
					Package (Unit : mm, Average)																								
NEW	NEW	NEW	NEW	NEW																									
S-VSON4	S-VSON(L)4	S-VSON4	S-VSON4	S-VSON4																									
<ul style="list-style-type: none"> New small S-VSON package Load voltage: 30 V Continuous load current : 1.5 A max. High Ambient operating temperature: -40 to +110°C 	<ul style="list-style-type: none"> New small S-VSON package (Low profile type) Load voltage: 40 V Low C x R = 4.95 pF · Ω High Ambient operating temperature: -40 to +110°C 	<ul style="list-style-type: none"> New small S-VSON package Load voltage: 60 V Low C x R = 13.2 pF · Ω High Ambient operating temperature: -40 to +110°C 	<ul style="list-style-type: none"> New small S-VSON package Load voltage: 60 V Continuous load current : 1A max. High Ambient operating temperature: -40 to +110°C 	<ul style="list-style-type: none"> New small S-VSON package Load voltage: 100 V Continuous load current : 0.65A max. High Ambient operating temperature: -40 to +110°C 	Features																								
Photodiode coupler					Isolation method																								
30 V	40 V	60 V		100 V	<table border="1"> <thead> <tr> <th>AC peak</th> <th>Load voltage</th> </tr> <tr> <th>DC</th> <th></th> </tr> </thead> <tbody> <tr><td>10,000</td><td rowspan="14">Continuous load current AC peak/ DC * 6-pin type connection C: DC</td></tr> <tr><td>9,000</td></tr> <tr><td>8,000</td></tr> <tr><td>7,000</td></tr> <tr><td>6,000</td></tr> <tr><td>5,000</td></tr> <tr><td>4,000</td></tr> <tr><td>3,000</td></tr> <tr><td>2,000</td></tr> <tr><td>1,000</td></tr> <tr><td>900</td></tr> <tr><td>800</td></tr> <tr><td>700</td></tr> <tr><td>600</td></tr> <tr><td>500</td></tr> <tr><td>400</td></tr> <tr><td>300</td></tr> <tr><td>200</td></tr> <tr><td>100</td></tr> </tbody> </table>	AC peak	Load voltage	DC		10,000	Continuous load current AC peak/ DC * 6-pin type connection C: DC	9,000	8,000	7,000	6,000	5,000	4,000	3,000	2,000	1,000	900	800	700	600	500	400	300	200	100
AC peak	Load voltage																												
DC																													
10,000	Continuous load current AC peak/ DC * 6-pin type connection C: DC																												
9,000																													
8,000																													
7,000																													
6,000																													
5,000																													
4,000																													
3,000																													
2,000																													
1,000																													
900																													
800																													
700																													
600																													
500																													
400																													
300																													
200																													
100																													
					Absolute maximum ratings																								
30 mA					LED forward current																								
500 VAC 50/60 Hz for 1 min. -40 to +110°C (with no icing or condensation)					Dielectric strength between I/O																								
-40 to +110°C (with no icing or condensation)					Ambient operating temperature																								
0.2 Ω	14 Ω	1.5 Ω	0.3 Ω	0.6 Ω	Maximum output ON resistance																								
1 nA (at 30 VDC)	1 nA (at 40 VDC)	1,000 nA (at 60 VDC)		1,000 nA (at 100 VDC)	Maximum OFF leakage current																								
● (S-VSON)					Surface-mounting terminals																								
					PCB terminals																								
Surface mounting					Mounting method																								
Compliant					Applicable standards																								
Approx. 0.01 g					RoHS compliance																								
					Weight																								
143	200	200	143	143	Page																								

* Only basic specifications are given in this table. Refer to the reference page given in the table for detailed specifications and precautions before you attempt to use a Relay.
* Refer to pages 218 to 220 for detailed information on models certified for standards.

MOS FET Relay Glossary

Item	Symbol	Description	
Absolute maximum ratings	---	Maximum values that must never be exceeded even instantaneously Unless otherwise specified, these values are given at Ta = 25°C.	
Input	LED forward current	I _F Rated current that can flow continuously in the LED forward direction	
	Repetitive peak LED forward current	I _{FP} Rated current that can flow momentarily in the LED forward direction	
	LED forward current reduction rate	ΔI _F /°C Reduction rate for current that can flow in the LED forward direction in relation to the ambient temperature	
	LED reverse voltage	V _R Rated reverse voltage that can be applied between the cathode and the anode	
	Connection temperature	T _J Rated temperature that can be allowed at the LED junction	
Output	Load voltage (AC peak/ DC)	V _{OFF} Rated voltage that can be applied between the relay output terminals when switching the load or in the OFF state The peak voltage for AC	
	Continuous load current (AC peak/ DC)	I _O Rated current that can flow between the relay output terminals in the ON state under the specified temperature conditions The peak current for AC	
	ON current reduction rate	ΔI _O /°C Reduction rate for current that can flow between the relay output terminals in the ON state in relation to the ambient temperature	
	Pulse ON current	I _{OP} Rated current that can flow instantaneously between the relay output terminals in the ON state	
	Connection temperature	T _J Rated temperature that can be allowed at the light-receiving circuit junction	
Dielectric strength between I/O	V _{I-O} Voltage that the isolation between the input and output can withstand for a specified time		
Ambient operating temperature	T _a Ambient temperature range in which the relay may be operated without impairment		
Ambient storage temperature	T _{stg} Ambient temperature range in the relay may be stored while not operating		
Soldering temperature	---	Rated temperature at which the terminals can be soldered without impairment of the relay	
Electrical characteristics	LED forward voltage	V _F Voltage drop between the LED anode and cathode at a certain forward current	
	Reverse current	I _R Leakage current flowing in the LED reverse direction (between cathode and anode)	
	Capacitance between terminals	C _T Electrostatic capacitance between the LED anode and the cathode terminals	
	Trigger LED forward current	---	Minimum input current required to change the relay output state. To ensure operation of the relay, a current that is equal to or greater than the maximum specified value must be used.
		I _{FT}	Minimum value of input current I _F that is required to change a MOS FET with a NO output to the ON state
		I _{FC}	Minimum value of input current I _F that is required to change a MOS FET with a NC output to the OFF state
	Release LED forward current	---	Maximum input current required to release the relay output state. To ensure release of the relay, a current that is equal to or less than the minimum specified value must be used.
		I _{FC}	Maximum value of input current I _F that must flow to change a MOS FET with a NO output to the OFF state
		I _{FT}	Maximum value of input current I _F that must flow to change a MOS FET with a NC output to the ON state
	Maximum resistance with output ON	R _{ON} Resistance between the relay output terminals in the specified ON state	
	Current leakage when the relay is open	I _{Leak} Leakage current flowing between the relay output terminals when the specified voltage is applied in the OFF state	
	Capacitance between terminals	C _{OFF} Electrostatic capacitance between the relay output terminals in the OFF state	
	Limit current	I _{LM} Load current that is maintained when current limiting is activated	
Capacitance between I/O terminals	C _{I-O} Electrostatic capacitance between the input and output terminals		
Insulation resistance between I/O terminals	R _{I-O} Resistance between the input and output terminals at the specified voltage value		
Turn-ON time	t _{ON} Time required for the output waveform to change after the specified input LED current is applied NO relay: Time required for the output waveform to change from 100% to 10% after the input changes from OFF to ON NC relay: Time required for the output waveform to change from 100% to 10% after the input changes from ON to OFF		
Turn-OFF time	t _{OFF} Time required for the output waveform to change after the specified input LED current is interrupted NO relay: Time required for the output waveform to change from 0% to 90% after the input changes from ON to OFF NC relay: Time required for the output waveform to change from 0% to 90% after the input changes from OFF to ON		
Equivalent rise time	ERT Indicator of the output transition characteristics for fast signals or pulse signals The ERT is expressed by the following formula, where t _{ri} is the input waveform rise time and t _{roff} is the output waveform rise time after relay transition. The lower the value, the less change there is in the signal, making for good characteristics. ERT = √(t _{roff} ² - t _{ri} ²)		

MOS FET Relay Glossary

	Item	Symbol	Description
Recommended operating conditions	Recommended operating conditions	---	Indicators of the maximum ratings and electrical performances that consider derating to ensure high reliability. Each item is an independent condition. Meeting compound conditions simultaneously is not considered.
	Load voltage (AC peak/ DC)	V_{DD}	Recommended load voltage that considers derating. The peak voltage for AC.
	Operating LED forward current	I_F	Recommended LED forward current that considers derating.
	Continuous load current (AC peak/ DC)	I_O	Recommended load current that considers derating. The peak current for AC.
	Ambient operating temperature	T_a	Recommended ambient operating temperature that considers derating.
Engineering data	ON-state voltage	V_{ON}	Voltage drop between the output terminals when the output MOS FET is in the ON state.
	Output terminal capacitance	$C_{OFF}/C_{OFF(0V)}$	Relative ratio based on the capacitance between output terminals when the voltage between the output terminals is 0 V.
Other terms	Current limiting	---	When an overcurrent exceeds a certain value, this function maintains the load current between the minimum and maximum values of the limit current characteristic. Suppressing the current to a fixed value protects the relay and the circuit components connected after the relay.
	Low C×R	---	Indicator of output characteristics in applications that handle high-frequency signals, fast signals, etc. C indicates the capacitance between the output terminals in the OFF state, COFF, and R indicates the resistance between the output terminals, RON, in the ON state. If COFF is large, signal transition even when the relay is OFF (signal leakage or isolation reduction) and the delay in the signal rise time for signal transition when the relay is ON (waveform rounding) are affected. If RON is large, signal transition loss (voltage drop and insertion reduction) is affected. In these applications, a small COFF and RON, i.e., a low C × R characteristic, are important.

Common Precautions for All MOS FET Relays

⚠ WARNING

Always turn OFF the power supply before wiring a Relay.

Not doing so may cause electrical shock.



Do not touch the current-carrying parts of the pin section of a MOS FET Relay while the power is being supplied.

An electrical shock may occur.



Precautions for Safe Use

1. Do not apply overvoltages or overcurrents to the input or output circuit of the MOS FET Relay.
The MOS FET Relay may fail or ignite.
2. Perform soldering and wiring correctly according to specified soldering conditions.
Using a MOS FET Relay with incomplete soldering may cause overheating when power is applied, possibly resulting in burning.

Precautions for Correct Use

●Derating

You must consider derating to achieve the required system reliability.

To use a MOS FET Relay with high reliability, consider derating the maximum ratings and recommended operating conditions, and allow sufficient leeway in designs based on testing operation in the actual application under the actual operating conditions whenever possible.

(1) Maximum Ratings

The maximum ratings must never be exceeded even instantaneously. This applies individually to each of the ratings. If any of the maximum ratings is exceeded, the internal parts of the MOS FET Relay may deteriorate or the chip may be destroyed. To ensure high reliability in using a MOS FET Relay, sufficiently derate the maximum voltage, current, and temperature ratings when designing the application.

(2) Recommended Operating Conditions

The recommended operating conditions are to ensure that the MOS FET Relay turns ON and OFF reliably. To ensure high reliability in using a MOS FET Relay, consider the recommended operating conditions when you design the application.

(3) Fail-safe Design

We recommend that you implement fail-safe measures in the design of the application if the failure of, deterioration of characteristics in, or functional errors in the MOS FET Relay will have a serious affect on the safe operation of the system.

●Countermeasures for static electricity

There is a risk of damage to internal elements and impairment of functionality if static electricity is discharged to the pins due to product handling or otherwise.

Reduce the generation of static electricity as much as possible, and implement appropriate measures to prevent charge accumulation near the product.

●Typical MOS FET Relay Driving Circuit Examples

The LED input side of the MOS FET is driven by current. If applying a Voltage, add resistance in series with the circuit, so the specified current is applied.

This resistance is referred as "LED current limiting resistance".

C-MOS

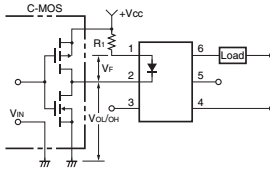

Transistor

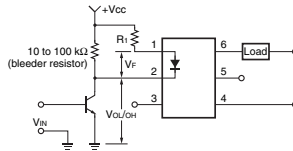

- To ensure that the MOSFET relay operates correctly, use the following formula to calculate the limiting resistance, and design the circuit accordingly.

$$R_1 = \frac{V_{CC} - V_{OL} - V_{F(ON)}}{I_F}$$

Note: To set the value of $I_{F(ON)}$, check the trigger LED current and recommended operation LED forward current indicated in the catalogue for each model, and set a high value with leeway.

- To ensure that the MOSFET relay resets reliably, calculate the reset voltage using the formula below, and control so that the voltage is lower than this value.

$$V_{F(OFF)} = V_{CC} - I_F R_1 - V_{OH}$$

Note: For the $I_{F(OFF)}$ value, set a value that is lower with leeway than the reset LED forward current indicated for each model in the catalogue.

- If the drive transistor has a large leakage current that may cause malfunctioning, add a bleeder resistance.

●Protection from Surge Voltage on the Input Pins

- If any reversed surge voltage is imposed on the input pins, insert a diode in parallel with the input pins as shown in the following circuit diagram and do not impose a reversed voltage of 3 V or higher.

Surge Voltage Protection Circuit Example

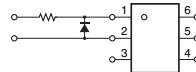

Common Precautions for All MOS FET Relays

●Protection from Spike Voltage on the Output Pins

- If there is an inductive load or other condition that will cause overvoltage that exceeds the absolute maximum rating between the output pins, connect a protective circuit to limit the overvoltage.

Spike Voltage Protection Circuit Example

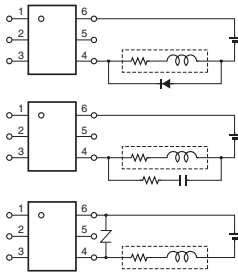

●Unused Pin

The unused pins of each MOSFET relay are used in the internal circuitry. Do not connect to an external circuit.

(Example for 6-pin Relay)

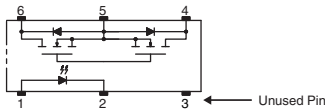

(Example of 8-pin high-capacity type)

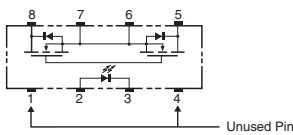

●Pin Strength for Automatic Mounting

- In order to maintain the characteristics of the MOS FET Relay, the force imposed on any pin of the MOS FET Relay for automatic mounting must not exceed the following limits.

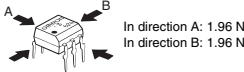

In direction A: 1.96 N
In direction B: 1.96 N

●Load Connection

- Do not short-circuit the input and output pins while the MOS FET Relay is operating or it may malfunction.

Example of correct connection

AC/DC connection (A connection)

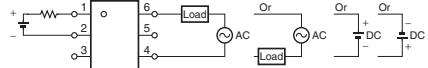

DC Single Connection (B connection)

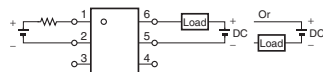

DC Parallel Connection (C connection)

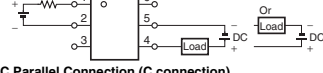

●Estimated Life

OMRON MOS FET Relays use mainly two types of LEDs. The service life is estimated separately for each type of LED.

The following tables show the LEDs that are used in each MOS FET Relay. Estimated life data is given on pages 3 and 4.

Ask your OMRON representative for any models that are not listed in the table.

This data is the results of estimating the service life from long-term data on a single lot. Use it only as reference data.

MOS FET Relays That Use GaAs LEDs

DIP	SOP		SSOP
G3VM-61A1/D1	G3VM-21GR	G3VM-S5	G3VM-21LR
G3VM-61B1/E1	G3VM-21GR1	G3VM-201H1	G3VM-21LR1
G3VM-62C1/F1	G3VM-41GR4	G3VM-202J1	G3VM-41LR4
G3VM-2L2/FL	G3VM-41GR5	G3VM-351G	G3VM-41LR5
G3VM-351A/D	G3VM-41GR6	G3VM-351G1	G3VM-41LR6
G3VM-351B/E	G3VM-41GR8	G3VM-351GL	G3VM-61LR
G3VM-352C/F	G3VM-61G1	G3VM-351H	G3VM-81LR
G3VM-353A/D	G3VM-61G2	G3VM-352J	G3VM-101LR
G3VM-353B/E	G3VM-61GR1	G3VM-353G	USOP
G3VM-354C/F	G3VM-61H1	G3VM-353H	G3VM-21PR10
G3VM-355CR/FR	G3VM-62J1	G3VM-354J	G3VM-21PR11
G3VM-WL/WFL	G3VM-81G1	G3VM-355JR	G3VM-41PR10
G3VM-401A/D	G3VM-81GR	G3VM-401G	G3VM-41PR11
G3VM-401B/E	G3VM-81GR1	G3VM-401H	G3VM-41PR12
G3VM-401B/EY/EY	G3VM-81HR	G3VM-402J	G3VM-51PR
G3VM-402C/F	G3VM-201G	G3VM-601G	G3VM-61PR
G3VM-601B/EY	G3VM-201G1		G3VM-61PR1

MOS FET Relays That Use GaAlAs LEDs

DIP	SOP	SSOP	SSOP
G3VM-21AR/DR	G3VM-61BR/ER	G3VM-21HR	G3VM-21LR10
G3VM-21BR/ER	G3VM-61BR1/ER1	G3VM-41HR	G3VM-41LR10
G3VM-41AR/DR	G3VM-101AR/DR	G3VM-61HR	G3VM-41LR11
G3VM-41BR/ER	G3VM-101BR/ER	G3VM-101HR	
G3VM-61AR/DR			

Introduction
General purpose
High-side voltage
Multi-contact pair (2a, 2b, and 1a1)
High-current and inductive strength
Small and high strength
High-dielectric strength
Current-limiting
Low-ohmic-resistance and low-resistance load-voltage
Small and High-temperature
Certified Models with Standards Derivation
DIP
SOP
SSOP
USOP
VSON
S-VSON
Common Precautions for All MOS FET Relays

Common Precautions for All MOS FET Relays

Data on Estimated Temporal Changes in GaAs LEDs

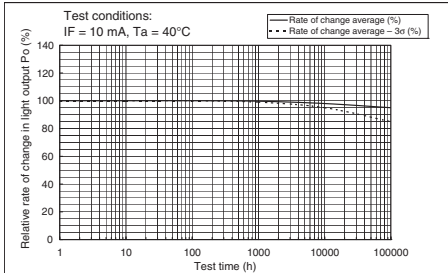
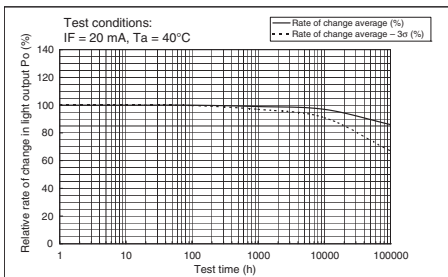
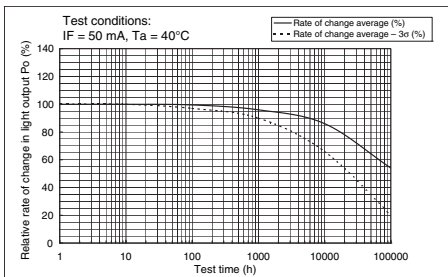

Estimated Life Data for GaAs LEDs

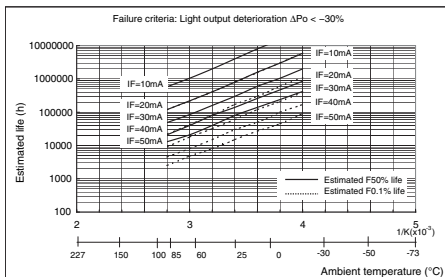
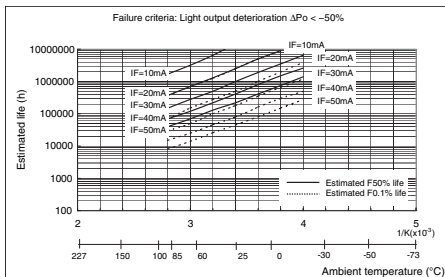

The above estimated life data is reference data that was based on LED long-term appraisal for a single lot.

Operating conditions that exceed the ratings for some models are included, but this in no way implies any warranty for operation that exceeds the ratings.

F50% Life:

For the life to a 50% cumulative failure rate, this is the time that is required for the AVG average line in the data on estimated temporal changes to reach the failure criteria.

F0.1% Life:

For the life to a 0.1% cumulative failure rate, this is the time that is required for the AVG-3 σ line in the data on estimated temporal changes to reach the failure criteria.

Whether to use estimated F50% life or F0.1% life should be determined based on the reliability required in the actual equipment, however, estimated F0.1% life is normally recommended.

"Optical output deterioration Δpo " is the amount of LED optical output deterioration compared to the initial LED output. When "Optical output deterioration failure criterion $\Delta po < -50\%$ ", a failure is detected when optical output has deteriorated 50% from the initial output.

Whether to use optical output deterioration $\Delta po < -50\%$ or $\Delta po < -30\%$ should be determined based on the amount of leeway to be provided in the LED forward current (IF) setting with respect to the trigger LED forward current (IF τ). However, the $\Delta po < -30\%$ graph is normally recommended.

Common Precautions for All MOS FET Relays

Data on Estimated Temporal Changes in GaAlAs LEDs

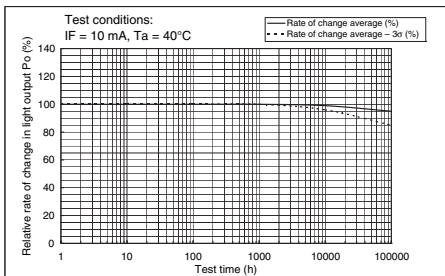
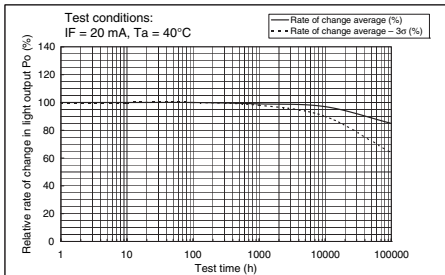
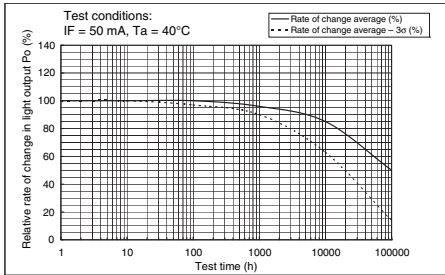

Estimated Life Data for GaAlAs LEDs

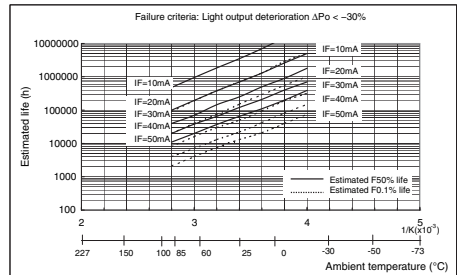
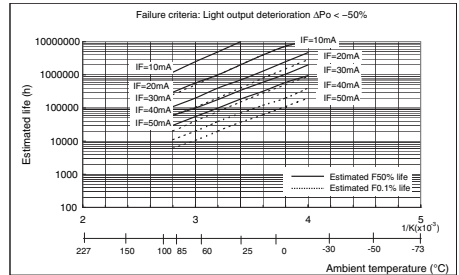

The above estimated life data is reference data that was based on LED long-term appraisal for a single lot. Operating conditions that exceed the ratings for some models are included, but this in no way implies any warranty for operation that exceeds the ratings.

F50% Life:

For the life to a 50% cumulative failure rate, this is the time that is required for the AVG average line in the data on estimated temporal changes to reach the failure criteria.

F0.1% Life:

For the life to a 0.1% cumulative failure rate, this is the time that is required for the AVG-3 σ line in the data on estimated temporal changes to reach the failure criteria.

Whether to use estimated F50% life or F0.1% life should be determined based on the reliability required in the actual equipment, however, estimated F0.1% life is normally recommended.

"Optical output deterioration Δpo " is the amount of LED optical output deterioration compared to the initial LED output. When "Optical output deterioration failure criterion $\Delta po < -50\%$ ", a failure is detected when optical output has deteriorated 50% from the initial output.

Whether to use optical output deterioration $\Delta po < -50\%$ or $\Delta po < -30\%$ should be determined based on the amount of leeway to be provided in the LED forward current (IF) setting with respect to the trigger LED forward current (IF_T). However, the $\Delta po < -30\%$ graph is normally recommended.

Common Precautions for All MOS FET Relays

●Cleaning Flux from the MOS FET Relays

- (1) Clean flux from the MOS FET Relay so that there will be no residue of reactive ions, such as sodium or chlorine. Some organic solvents will react with water to produce hydrogen chloride or other corrosive gases, which may cause deterioration of the MOS FET Relays.
- (2) When washing off the flux with water, make sure that there will be no residue of reactive ions, particularly sodium or chlorine.
- (3) During water washing, do not scrub the marks on the surface of the MOS FET Relay with a brush or your hand while there is cleaning liquid on the MOS FET Relay. The marks may come off.
- (4) Clean the flux from the MOS FET Relays with the chemical action of the solvent for submersed cleaning, shower cleaning, or steam cleaning. To minimize the effect on the MOS FET Relays, do not place the MOS FET Relay in the solvent or steam for more than 1 minute at a temperature of 50°C.
- (5) If you use ultrasonic cleaning, keep the time short. If the cleaning time is too long, the sealing characteristics of the molded resin and frame materials may deteriorate. The recommended basic conditions are given below.

Recommended Conditions for Ultrasonic Cleaning:

Frequency: 27 to 29 kHz
Ultrasonic wave output: 300 W max. (0.25 W/cm² max.)
Cleaning time: 30 s max.

Also, suspend the MOS FET Relays in the cleaning solution so that the MOS FET Relay and PCB do not come into direct contact with the ultrasonic transducer.

●Solder Mounting

Perform solder mounting under the following recommended conditions to prevent the temperature of the MOS FET Relays from rising.

<Flow Soldering>

PCB Terminals

(Set Temperature of Flow Bath)

Solder type	Preheating	Soldering	Count
(Lead solder) SnPb	150°C 60 to 120 s	260°C 10 s max.	Once only
(Lead-free solder) SnAgCu	150°C 60 to 120 s	260°C 10 s max.	Once only

Note: We recommend that you verify the suitability of solder mounting under actual conditions.

Surface-mount Terminals

If you are considering mounting a surface mount pin type by flow soldering, please consult us.

<Reflow Soldering>

Surface-mount Terminals

(Surface Temperature of Package)

Solder type	Preheating	Soldering	Count
(Lead solder) SnPb	140 to 160°C 60 to 120 s	210°C 30 s max.	Up to twice

(Lead-free solder) SnAgCu recommended profile

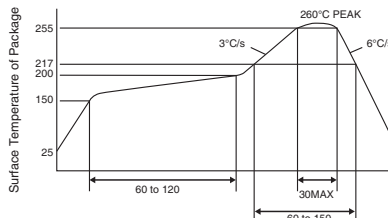

Reflow repetitions : Up to twice Time (s)

- Note: 1. We recommend that you verify the suitability of solder mounting under actual conditions.
2. When SSOP, USOP, VSON, or S-VSON products are ordered with (TR), tape package product is delivered in moisture-proof packaging. If ordered without (TR), tape-cut product is delivered in non moisture-proof packaging. Mount a tape cut product by manual soldering. Tape cut products absorb moisture because a non moisture-proof package is used. Risk of package cracking or other damage due to thermal stress if reflow soldering is performed.

Manual Soldering (Once Only)

Perform manual soldering at 350°C for 3 s or less or at 260°C for 10 s or less.

Note: Please consult us for manual soldering conditions for S-VSON products.

●Storage Conditions

- (1) Store the MOS FET Relay where they will not be subjected to water leaks or direct sunlight.
- (2) When transporting or storing the MOS FET Relays, observe all precautions on the packaging boxes.
- (3) Keep the storage location at normal temperature, normal humidity, and normal pressure. Guidelines for the temperature and humidity are 5 to 35°C and a relative humidity of 45% to 75%.
- (4) Do not store the MOS FET Relay in locations that are subject to corrosive gases, such as hydrogen sulfide gas, or to salt spray, and do not store them where there is visually apparent dust or dirt.
- (5) Store the MOS FET Relay in a location that has a relatively stable temperature. Radical changes in temperature during storage will cause condensation, which may oxidize or corrode the leads and interfere with solder wetting.
- (6) If you remove MOS FET Relays from the packages and then store them again, use storage containers that have measures to prevent static electricity.
- (7) Do not under any circumstances apply any force to the MOS FET Relays that would deform or alter them in any way.
- (8) This product is warranted for one year from the date of purchase or the date of delivery to the specified location. If the MOS FET Relays are stored for more than about one year under normal conditions, we recommend that you confirm solderability before you use the MOS FET Relays.

Common Precautions for All MOS FET Relays

●Usage Conditions

<Temperature>

The electrical characteristics of the MOS FET Relays are limited by the application temperature.

If you use them at temperatures outside of the operating temperature range, the electrical characteristics of the MOS FET Relays will not be achieved and the MOS FET Relays may deteriorate. For that reason, you must determine the temperature characteristics in advance and apply derating* to the design of the application. (*Derating reduces stress.)

Consider derating in the operating temperature conditions and apply the recommended operating temperature as a guideline.

<Humidity>

If the MOS FET Relays are used for a long period of time at high humidity, humidity will penetrate the Relays and the internal chips may deteriorate or fail. In systems with high signal source impedance, leaks in the board or leaks between the leads of the MOS FET Relays can cause malfunctions. If these are issues, consider applying humidity-resistant processing to the surfaces of the MOS FET Relays. On the other hand, at low humidity, damage from the discharge of static electricity becomes a problem. Low humidity may cause damage due to electrostatic discharge. Unless moisture proofing is implemented, use within a relative humidity range of 40 to 60%.

●Considerations when handling SSOP, USOP, VSON, and S-VSON products

<Moisture proof package, MSL3> (Other packages are MSL1)

Surface mount products may have a crack when thermal stress is applied during surface mount assembly after they absorb atmospheric moisture. Therefore, please observe the following precautions.

- This moisture proof bag may be stored unopened within 12 months at the following conditions.
Temperature: 5°C to 30°C
Humidity: 90% (Max.)
- After opening the moisture proof bag, the devices should be assembled within 168 hours in an environment of 5°C to 30°C / 70%RH or below.
- If upon opening, the moisture indicator card shows humidity 30% or above (Color of indication changes to pink) or the expiration date has passed, the devices should be baked in taping with reel. After baking, use the baked devices within 72 hours, but perform baking only once.
Baking conditions: 60±5°C. For 64 to 72 hours.
Expiration date: 12 months from sealing date, which is imprinted on the label affixed.
- Repeated baking can cause the peeling strength of the taping to change, then leads to trouble in mounting. Furthermore, prevent the devices from being destructed against static electricity for baking of it.
- If the packing material of laminate would be broken the hermeticity would deteriorate. Therefore, do not throw or drop the packed devices.
- Tape-cut SSOPs, USOPs, VSONs, or S-VSON are packaged without humidity resistance. Use manual soldering to mount them. (MSL not supported)

●Tape Packaging

<Tape Form and Dimensions>

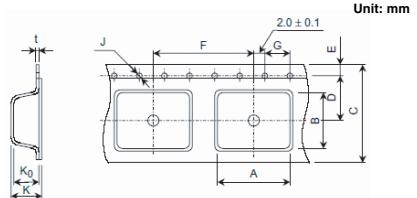

Unit: mm

Type of package		DIP4	DIP6	DIP8	Special SOP4	SOP4	
Dimension symbol (See figure.)	Dimensions	A	10.4±0.1		4.0±0.1	4.3±0.1	
		B	5.1±0.1	7.6±0.1	10.1±0.1	7.6±0.1	7.5±0.1
		C	16±0.3			12±0.3	
		D	7.5±0.1			5.5±0.1	
		E	1.75±0.1				
		F	12.0±0.1			8.0±0.1	
		G	4.0±0.1				
		J	1.5+0.1/-0				
		k	4.55±0.2		2.9±0.2		2.6±0.2
		ko	4.1±0.1		2.6±0.1		2.4±0.1
t	0.4±0.05						

Unit: mm

Type of package		SOP6	SOP8	SSOP4	USOP4	VSON4	S-VSON4	
Dimension symbol (See figure.)	Dimensions	A	7.5±0.1		2.35±0.2	2.6±0.1	1.6±0.1	
		B	6.7±0.1	10.5±0.1	4.5±0.1	3.55±0.1	3.0±0.1	2.25±0.1
		C	16±0.3		12±0.3		8.0±0.3	
		D	7.5±0.1		5.5±0.1		3.5±0.1	
		E	1.75±0.1					
		F	12.0±0.1		4.0±0.1			
		G	4.0±0.1					
		J	1.5+0.1/-0					
		k	2.5±0.2	2.4±0.2	2.4±0.1	2.25±0.1	—	
		ko	2.3±0.1	2.2±0.1	2.1±0.1	1.95±0.1	1.5±0.1	1.85±0.1
t	0.3±0.05			0.3±0.1		0.2±0.05		

<Reel Form and Dimensions>

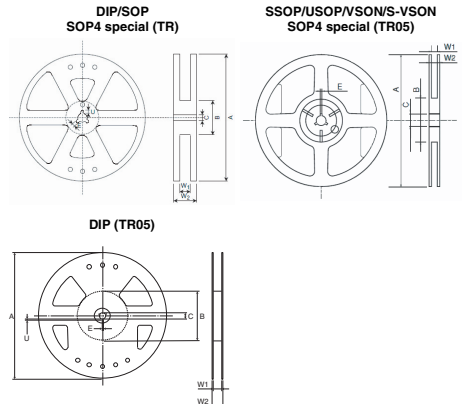

Common Precautions for All MOS FET Relays

Unit: mm

Type of package	DIP4	DIP6	DIP8	Special SOP4	SOP4	SOP6	SOP8	
Type name	(TR05)		(TR)					
Dimensions (See figure.)	A	254±2 dia.		380±2 dia.		330±2 dia.		
	B	100±1 dia.		80±1 dia.				
	C	13±0.2 dia.		13±0.5 dia.				
	E	2.0±0.5		2.0±0.5				
	U	4.0		4.0±0.5				
	W1	17.4±1.0		17.5±0.5		13.5±0.5		17.5±0.5
	W2	21.4±1.0		21.5±1.0		17.5±1.0		21.5±1.0

Type of package	Special SOP4	SSOP4	USOP4	VSON4	S-VSON4	
Type name	(TR05)					
Dimensions (See figure.)	A	180±2.0 dia.		180+0/-4 dia.		180±3 dia.
	B	60±1.0 dia.		60 dia.		60±1 dia.
	C	13±0.5 dia.		13 dia.		13±0.5 dia.
	E	2.0±0.5				
	U	4.0±0.5 dia.		---		4.0±0.5
W1	13.5±0.5 dia.		13±0.3		9.0±0.3	
W2	17.5±1.0 dia.		15.4±1.0		11.4±1.0	

<Taping Direction>

The orientations of the MOS FET Relays in the depressions in the carrier tapes are shown below.

(1) SOP4 Pins

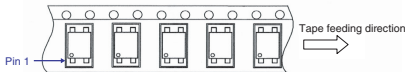

(2) SOP6, SOP8, DIP4, DIP6, or DIP8 Pins

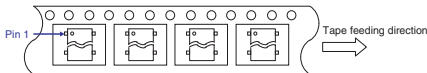

(3) SSOP4, USOP4, VSON4, S-VSON4 pin types

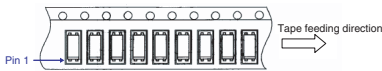

<Number of Relays Per Reel>

Type of package	DIP4	DIP6	DIP8	Special SOP4	SOP4	SOP6	SOP8
Number of Relays	TR		1,500		3,000		2,500
	TR05		500		-		500

Type of package	SSOP4	USOP4	VSON4	S-VSON4
Number of Relays	TR			
	TR05			
	-			
	500			

●Stick packaging

<Stick shape and dimensions>

Unit: mm

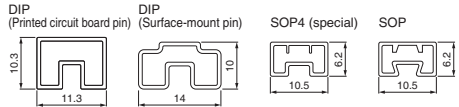

Type of package	DIP4	DIP6	DIP8	DIP4	DIP6	DIP8	Special SOP4	SOP4	SOP6	SOP8
Pin type	Printed circuit board pin			Surface-mount pin						
Number of Relays	100	50	50	100	50	50	125	100	75	50
Height (mm)	10.3			10			6.2			
Width (mm)	11.3			14			10.5			
Length (mm)	525			525			555			

MEMO

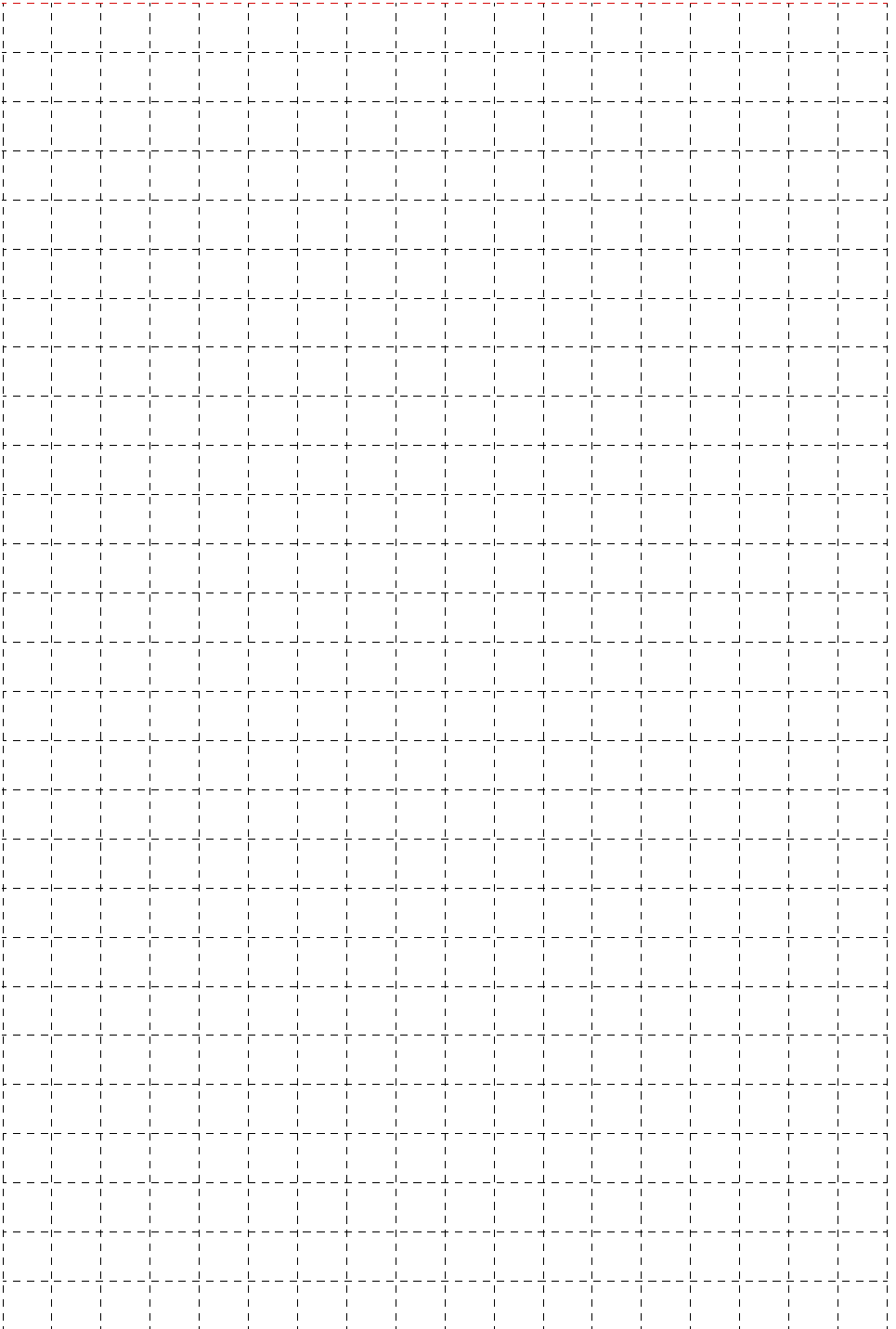

G3VM-□A□/□D□/□B□/□E□

MOS FET Relays DIP, General-purpose Type

General-purpose MOS FET Relays in DIP packages for a wide range of applications

- Package: DIP 4-pin or DIP 6-pin
- Contact form: 1a (SPST-NO) or 1b (SPST-NC)
- Load voltage: 60 V, 350 V, or 400 V

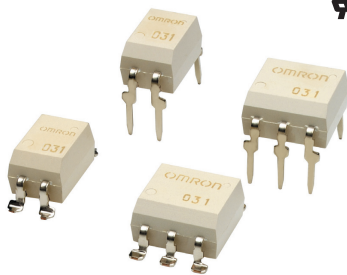

Note: The actual product is marked differently from the image shown here.

RoHS Compliant

Application Examples

- Communication equipment
- Security equipment
- Power circuit
- Test & Measurement equipment
- Industrial equipment

Package

(Unit : mm, Average)

DIP 4-pin

DIP 6-pin

PCB Terminals

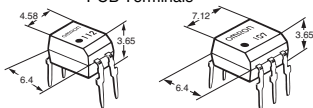

Surface-mounting Terminals

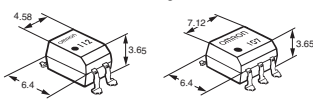

Note: The actual product is marked differently from the image shown here.

Model Number Legend

G3VM-□□□□
1 2 3 4

1. Load Voltage

- 6 : 60 V
- 35 : 350 V
- 40 : 400 V

2. Contact form

- 1 : 1a (SPST-NO)
- 3 : 1b (SPST-NC)

3. Package

- A : DIP 4-pin with PCB terminals
- B : DIP 6-pin with PCB terminals
- D : DIP 4-pin with surface-mounting terminals
- E : DIP 6-pin with surface-mounting terminals

4. Other informations

When specifications overlap, serial code is added recorded order.

Ordering Information

Package	Contact form	Load voltage (peak value) *	Continuous load current (peak value) *	Stick packaging			Tape packaging	
				Model		Minimum package quantity	Model	Minimum package quantity
				PCB Terminals	Surface-mounting Terminals			
DIP4	1a (SPST-NO)	60 V	500 mA	G3VM-61A1	G3VM-61D1	100 pcs.	G3VM-61D1(TR)	1,500 pcs.
			120 mA	G3VM-351A	G3VM-351D		G3VM-351D(TR)	
	1b (SPST-NC)	350 V	150 mA	G3VM-353A	G3VM-353D		G3VM-353D(TR)	
			400 V	120 mA	G3VM-401A		G3VM-401D	

Package	Contact form	Load voltage (peak value) *	Continuous load current (peak value) *	Stick packaging				Tape packaging	
				Model		Minimum package quantity	Model	Minimum package quantity	
				Connection A, B	Connection C				PCB Terminals
DIP6	1a (SPST-NO)	60 V	500 mA	1000 mA	G3VM-61B1	G3VM-61E1	50 pcs.	G3VM-61E1(TR)	1,500 pcs.
			120 mA	240 mA	G3VM-351B	G3VM-351E		G3VM-351E(TR)	
	1b (SPST-NC)	350 V	150 mA	300 mA	G3VM-353B	G3VM-353E		G3VM-353E(TR)	
			400 V	120 mA	240 mA	G3VM-401B		G3VM-401E	

* The AC peak and DC value are given for the load voltage and continuous load current.

Note: To order tape packaging for Relays with surface-mounting terminals, add "(TR)" to the end of the model number.

■ Absolute Maximum Ratings (Ta = 25°C)

Item	Symbol	G3VM-61A1 G3VM-61D1	G3VM-61B1 G3VM-61E1	G3VM-351A G3VM-351D	G3VM-351B G3VM-351E	G3VM-353A G3VM-353D	G3VM-353B G3VM-353E	G3VM-401A G3VM-401D	G3VM-401B G3VM-401E	Unit	Measurement conditions	
Input	LED forward current	I _F								50	mA	
	Repetitive peak LED forward current	I _{FP}								1	A	100 μs pulses, 100 pps
	LED forward current reduction rate	ΔI _F /°C								-0.5	mA/°C	Ta ≥ 25°C
	LED reverse voltage	V _R								5	V	
	Connection temperature	T _J								125	°C	
Output	Load voltage (AC peak/DC)	V _{OFF}		60	350		400			V		
	Continuous load current (AC peak/DC)	Connection A	500		120		150		120		mA	Connection A: AC peak/DC Connection B and C: DC
		Connection B	500		120		150		120			
		Connection C	1000		240		300		240			
	ON current reduction rate	Connection A	-5		-1.2		-1.5		-1.2		mA/°C	Ta ≥ 25°C
		Connection B	-5		-1.2		-1.5		-1.2			
		Connection C	-10		-2.4		-3		-2.4			
Pulse ON current	I _{OP}		1.5		0.36		0.45		0.36		A	t=100 ms, Duty=1/10
Connection temperature	T _J								125	°C		
Dielectric strength between I/O *	V _{I-O}								2,500	V _{rms}	AC for 1 min	
Ambient operating temperature	T _a								-40 to +85	°C	With no icing or condensation	
Ambient storage temperature	T _{stg}								-55 to +125	°C		
Soldering temperature	-								260	°C	10 s	

* The dielectric strength between the input and output was checked by applying voltage between all pins as a group on the LED side and all pins as a group on the light-receiving side.

Connection Diagram (DIP 6-pin Relays)

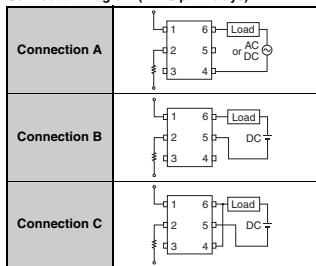

G3VM-□A□/□D□/□B□/□E□

MOS FET Relays

■Electrical Characteristics (Ta = 25°C)

Item	Symbol	G3VM-61A1 G3VM-61D1		G3VM-61B1 G3VM-61E1		G3VM-351A G3VM-351D		G3VM-351B G3VM-351E		G3VM-353A G3VM-353D		G3VM-353B G3VM-353E		G3VM-401A G3VM-401D		G3VM-401B G3VM-401E		Unit	Measurement conditions	
LED forward voltage	V _F	Minimum		1.0														V	I _F =10 mA	
		Typical		1.15																
		Maximum		1.3																
Reverse current	I _R	Maximum		10														μA	V _R =5 V	
		Typical		30																
Capacitance between terminals	C _T	Typical		1.6				1										pF	V=0, f=1 MHz	
Trigger LED forward current	I _{FT} (I _{FC}) *2	Typical		1.6				1												mA
		Maximum		3																
Release LED forward current	I _{FC} (I _{FT}) *2	Minimum		0.1														mA	G3VM-353A/353D/ 353B/353E : I _o =150 mA Others : I _{OFF} =100 μA	
Maximum resistance with output ON	R _{ON}	Typical	Connection A		1		35 (25)		15		18		17							Ω
			Connection B		0.5		28		8		4		11							
			Connection C		0.25		14		4		6									
		Maximum	Connection A		2		50 (35)		25		35									
			Connection B		1		40		14		20									
			Connection C		-		20		7		10									
Current leakage when the relay is open	I _{LEAK}	Maximum		1														μA	G3VM-353A/353D/ 353B/353E : I _F =5 mA, V _{OFF} =Load voltage ratings Others : V _{OFF} =Load voltage ratings	
Capacitance between terminals	C _{OFF}	Typical		130		30		85		40										
Capacitance between I/O terminals	C _{I-O}	Typical		0.8														pF	f=1 MHz, V _S =0 V	
Insulation resistance between I/O terminals	R _{I-O}	Minimum		1000																MΩ
		Typical		10 ⁸																
Turn-ON time	t _{ON}	Typical		0.8		0.3		0.1		-		0.3						ms	I _F =5 mA, R _L =200 Ω, V _{DD} =10 V *1	
		Maximum		2				1												
Turn-OFF time	t _{OFF}	Typical		0.1				1		-		0.1						ms	I _F =5 mA, R _L =200 Ω, V _{DD} =10 V *1	
		Maximum		0.5		1		3		1										

*1. Turn-ON and Turn-OFF Times

*2. These values are for Relays with NC contacts

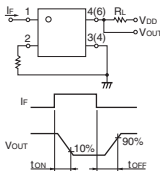

■Recommended Operating Conditions

For usage with high reliability, Recommended Operation Conditions is a measure that takes into account the derating of Absolute Maximum Ratings and Electrical Characteristics.

Each item on this list is an independent condition, so it is not simultaneously satisfy several conditions.

Item	Symbol	G3VM-61A1 G3VM-61D1		G3VM-61B1 G3VM-61E1		G3VM-351A G3VM-351D		G3VM-351B G3VM-351E		G3VM-353A G3VM-353D		G3VM-353B G3VM-353E		G3VM-401A G3VM-401D		G3VM-401B G3VM-401E		Unit
Load voltage (AC peak/DC)	V _{DD}	Maximum		48				280				320						V
Operating LED forward current	I _F	Minimum						5										
		Typical		7.5		10		25		7.5								
		Maximum																
Continuous load current (AC peak/DC)	I _o	Maximum		500		100		150		100		120						°C
Ambient operating temperature	T _a	Minimum						-20										
		Maximum								65								

G3VM-□A□/□D□/□B□/□E□

MOS FET Relays

■ Spacing and Insulation

Item	Minimum	Unit
Creepage distances	7.0	mm
Clearance distances	7.0	
Internal isolation thickness	0.4	

■ Engineering Data

● LED forward current vs. Ambient temperature

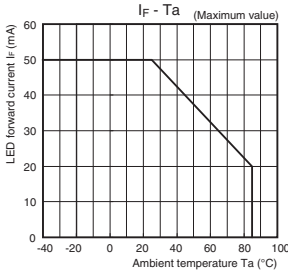

● LED forward current vs. LED forward voltage

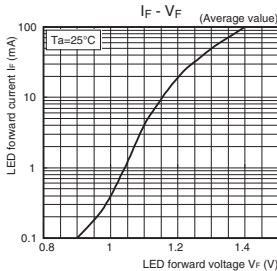

● On-state resistance vs. Ambient temperature

G3VM-61A1/61D1/61B1/61E1

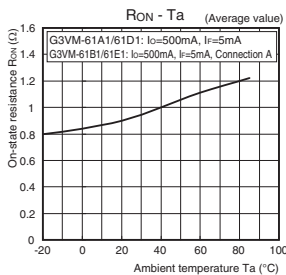

● Continuous load current vs. Ambient temperature

G3VM-61A1/61D1/61B1/61E1

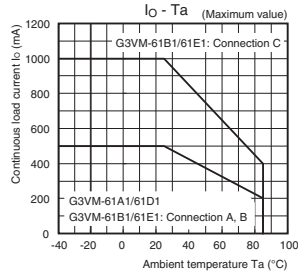

● Continuous load current vs. On-state voltage

G3VM-61A1/61D1/61B1/61E1

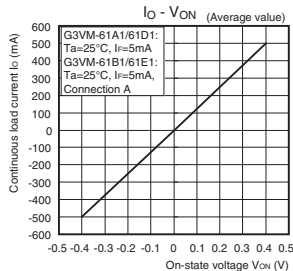

G3VM-351A/351D/351B/351E G3VM-353A/353D/353B/353E G3VM-401A/401D/401B/401E

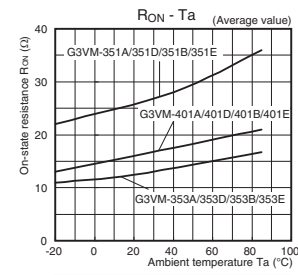

G3VM-351A/351D/401A/401D:
Io=120mA, If=5mA, t<1s
G3VM-351B/351E/401B/401E:
Io=120mA, If=5mA, t<1s, Connection A
G3VM-353A/353D: Io=150mA, t<1s
G3VM-353B/353E: Io=150mA, t<1s, Connection A

G3VM-351A/351D/351B/351E G3VM-353A/353D/353B/353E G3VM-401A/401D/401B/401E

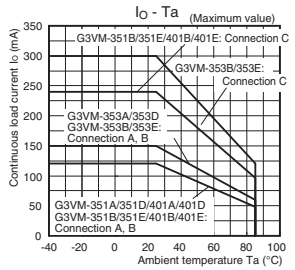

G3VM-351A/351D/351B/351E G3VM-353A/353D/353B/353E G3VM-401A/401D/401B/401E

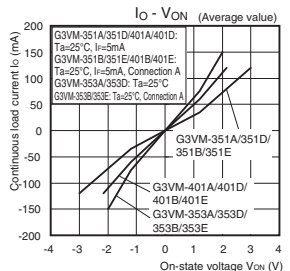

● Trigger LED forward current vs. Ambient temperature

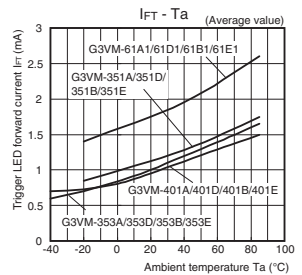

G3VM-61A1/61D1/351A/351D/401A/401D:
Io=Continuous Load Current Ratings, t<1s
G3VM-61B1/61E1/351B/351E/401B/401E:
Io=Continuous Load Current Ratings, t<1s, Connection A
G3VM-353A/353D: Ioff=10μA
G3VM-353B/353E: Ioff=10μA, Connection A

Introduction
General purpose
High-level-voltage
Multi-contact pair
High-current and
Low-on-resistance
Small and high-
current-straight
High-dielectric-
strength
Current-limiting
Low-on/off-resistance
Small and High-
level-voltage
Certified Models with
Statistical Certification
DIP
SSOP
USOP
VSON
S-VSON
G3VM-□A□/□D□/□B□/□E□

G3VM-□A□/□D□/□B□/□E□

MOS FET Relays

Engineering Data

● Turn ON, Turn OFF time vs. LED forward current
LED forward current
G3VM-61A1/61D1/61B1/61E1

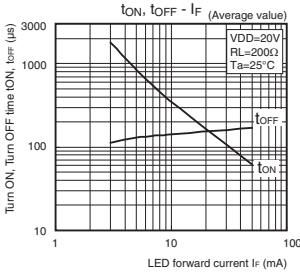

G3VM-351A/351D/351B/351E
G3VM-353A/353D/353B/353E
G3VM-401A/401D/401B/401E

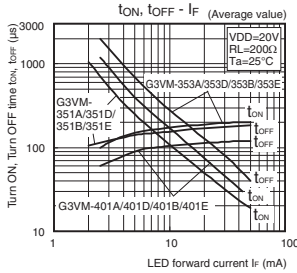

● Turn ON, Turn OFF time vs. Ambient temperature
Ambient temperature
G3VM-61A1/61D1/61B1/61E1

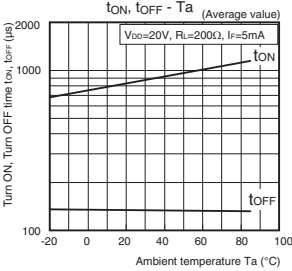

G3VM-351A/351D/351B/351E
G3VM-353A/353D/353B/353E
G3VM-401A/401D/401B/401E

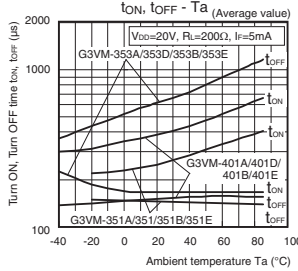

● Current leakage vs. Ambient temperature

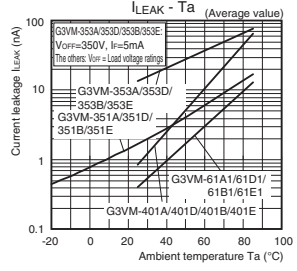

Appearance / Terminal Arrangement / Internal Connections

● Appearance

DIP (Dual Inline Package)
DIP 4-pin

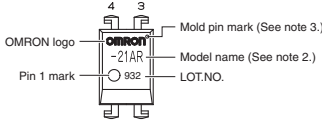

DIP 6-pin

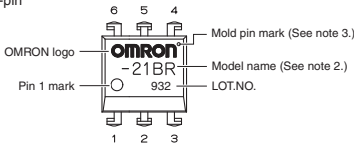

● Terminal Arrangement/Internal Connections (Top View)

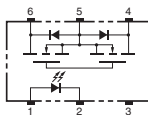
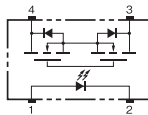

Note: 1. The actual product is marked differently from the image shown here.

Note: 2. "G3VM" does not appear in the model number on the Relay.

Note: 3. The indentation in the corner diagonally opposite from the pin 1 mark is from a pin on the mold.

G3VM-□A□/□D□/□B□/□E□

MOS FET Relays

■Dimensions (Unit: mm)

DIP4

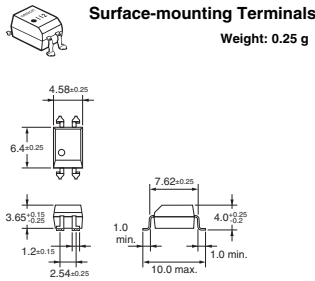
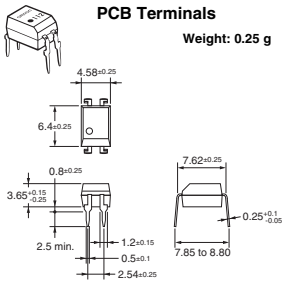

PCB Dimensions (BOTTOM VIEW)

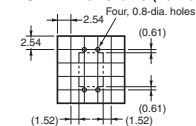
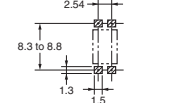
Actual Mounting Pad Dimensions
(Recommended Value, Top View)

Note: The actual product is marked differently from the image shown here.

DIP6

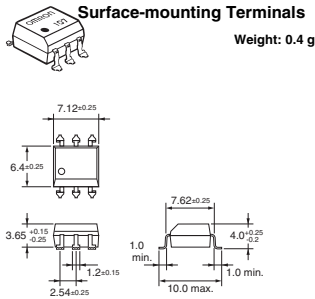
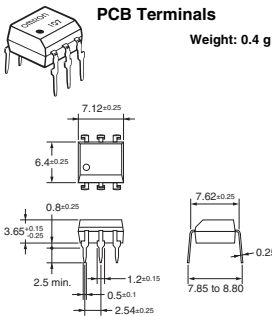

PCB Dimensions (BOTTOM VIEW)

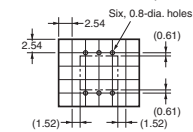
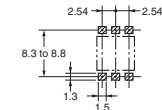
Actual Mounting Pad Dimensions
(Recommended Value, Top View)

Note: The actual product is marked differently from the image shown here.

■Approved Standards

UL recognized

Model				Approved Standards	Contact form	File No.
G3VM-61A1	G3VM-61D1	G3VM-61B1	G3VM-61E1	UL (recognized)	1a (SPST-NO)	E80555
G3VM-351A	G3VM-351D	G3VM-351B	G3VM-351E			
G3VM-401A	G3VM-401D	G3VM-401B	G3VM-401E			
G3VM-353A	G3VM-353D	G3VM-353B	G3VM-353E			

Models Certified by BSI for EN/IEC Standards

Model	Approved Standards	Contact form	File No.
G3VM-351A G3VM-351D	EN 60950/EN 60065 (BSI certified)	1a (SPST-NO)	8816 8817

■Safety Precautions

- Refer to the *Common Precautions for All MOS FET Relays* for precautions that apply to all MOS FET Relays.

Introduction
General purpose
High-side-voltage
Multi-contact pair
Low-Ohm-resistance
High-current and
Low-Ohm-resistance
Small and high-
dielectric-strength
High-dielectric-
strength
Current-limiting
Low-ohmic-resistance
High-voltage
Small and High-
voltage
Certified models with
standards certification
DIP
SOP
SSOP
USOP
VSON
S-VSON

G3VM-□A□/□D□/□B□/□E□

G3VM-6□G□/61VY□

MOS FET Relays SOP 4-pin, General-purpose Type

General-purpose MOS FET Relays in SOP 4-pin packages for a wide range of applications

- Contact form: 1a (SPST-NO) or 1b (SPST-NC)
- Load voltage: 60 V



NEW

Note: The actual product is marked differently from the image shown here.

RoHS Compliant

Application Examples

- Semiconductor test equipment
- Test & Measurement equipment
- Communication equipment
- Security equipment
- Industrial equipment
- Power circuit
- Amusement equipment

Package (Unit: mm, Average)

SOP 4-pin

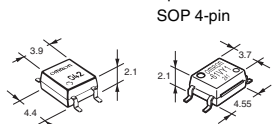

Note: The actual product is marked differently from the image shown here.

Model Number Legend

G3VM-□□□□□
1 2 3 4 5

1. Load voltage

6: 60 V

2. Contact form

1: 1a (SPST-NO)
3: 1b (SPST-NC)

3. Package

G: SOP 4-pin
V: Special SOP 4-pin

4. Additional functions

None: Dielectric strength between I/O 1500 V
Y: Dielectric strength between I/O 3750 V

5. Other informations

When specifications overlap, serial code is added in the recorded order.

Ordering Information

Package	Contact form	Terminals	Load voltage (peak value) *	Continuous load current (peak value) *	Stick packaging		Tape packaging	
					Model	Minimum package quantity	Model	Minimum package quantity
SOP4	1a (SPST-NO)	Surface-mounting Terminals	60 V	400 mA	G3VM-61G1	100 pcs.	G3VM-61G1(TR)	2500 pcs.
				100 mA	G3VM-61G2		G3VM-61G2(TR)	
				500 mA	G3VM-61VY1	125 pcs.	G3VM-61VY1(TR)	3000 pcs.
				700 mA	G3VM-61VY2		G3VM-61VY2(TR05)	500 pcs.
SOP4	1b (SPST-NC)			500 mA	G3VM-61VY3	100 pcs.	G3VM-61VY3(TR)	3000 pcs.
					G3VM-63G		G3VM-63G(TR05)	500 pcs.

* The AC peak and DC value are given for the load voltage and continuous load current.

Note: To order tape packaging for Relays with surface-mounting terminals, add "(TR)" or "(TR05)" to the end of the model number.

Absolute Maximum Ratings (Ta = 25°C)

Item	Symbol	G3VM-61G1	G3VM-61G2	G3VM-61G3	G3VM-61VY1	G3VM-61VY2	G3VM-61VY3	G3VM-63G	Unit	Measurement conditions
LED forward current	If	50			30			50	mA	
LED forward current reduction rate	$\Delta I_f/^\circ\text{C}$	-0.5			-0.3			-0.5	mA/°C	Ta ≥ 25°C
LED reverse voltage	Vr		5			6		5	V	
Connection temperature	Tj				125				°C	
Load voltage (AC peak/DC)	Voff				60				V	
Continuous load current (AC peak/DC)	Io	400			100	500	700	500	mA	
ON current reduction rate	$\Delta I_o/^\circ\text{C}$	-4.0			-1.0	-5.0	-7.0	-5.0	mA/°C	Ta ≥ 25°C
Pulse ON current	Iop	1200			300	1500	2100	1500	mA	t = 100 ms, Duty = 1/10
Connection temperature	Tj				125				°C	
Dielectric strength between I/O *	Vl-o	1500			3750			1500	Vrms	AC for 1 min
Ambient operating temperature	Ta		-40 to +85			-40 to +110		-40 to +105	°C	With no icing or condensation
Ambient storage temperature	Tstg				-55 to +125				°C	
Soldering temperature	-				260				°C	10 s

* The dielectric strength between the input and output was checked by applying voltage between all pins as a group on the LED side and all pins as a group on the light-receiving side.

G3VM-6□G□/61VY□

MOS FET Relays

■Electrical Characteristics (Ta = 25°C)

Item	Symbol		G3VM-61G1	G3VM-61G2	G3VM-61G3	G3VM-61VY1	G3VM-61VY2	G3VM-61VY3	G3VM-63G	Unit	Measurement conditions		
Input	LED forward voltage	Minimum	1.0			1.1			1.0	V	If=10 mA		
		Typical	1.15			1.27			1.15				
		Maximum	1.3			1.4			1.3				
	Reverse current	Ir	Maximum 10									μA	Vr=5 V
	Capacitance between terminals	Ct	Typical 30 50 30									pF	V=0, f=1 MHz
	Trigger LED forward current	IfT (Ifc) *2	Typical	1.6	0.4	–	0.2	1		0.6	mA	G3VM-61G1/61G2/61G3/61VY1: Io=400 mA G3VM-61VY1: Io=100 mA G3VM-61VY2: Io=500 mA G3VM-61VY3: Io=700 mA G3VM-63G: IoFF=10 μA	
Maximum			3	1	0.2	1	3						
Release LED forward current	Ifc (IfT) *2	Minimum	0.1		–	0.01	0.1			mA	G3VM-61G1/61G2/61G3/61VY1/61VY2/61VY3: IoFF=100 μA G3VM-63G: Io=500 mA		
		Typical	–		0.001	–	0.5	–					
Output	Maximum resistance with output ON	Typical	1			25	1	0.15	1	Ω	G3VM-61G1:If=5 mA, Io=400 mA G3VM-61G2:If=2 mA, Io=400 mA G3VM-61G3 :If=0.5 mA, Io=400 mA, t<1s G3VM-61VY1 :If=2 mA, Io=100 mA, t<1s G3VM-61VY2 :If=5 mA, Io=500 mA G3VM-61VY3 :If=5 mA, Io=700 mA G3VM-63G: Io=500 mA		
		Maximum	2			50	2	2.5					
	Current leakage when the relay is open	I _{LEAK}	Typical – 1 – – 2 – Maximum 1000									nA	V _{OFF} =60 V
Capacitance between terminals	C _{OFF}	Typical 130 10 20 100									pF	G3VM-61G1/61G2/61G3/61VY1/61VY2/61VY3: V=0, f=1 MHz G3VM-63G: V=0, f=1 MHz, If=5 mA	
Capacitance between I/O terminals	C _{I-O}	Typical 0.8									pF	f=1 MHz, V _s =0 V	
Insulation resistance between I/O terminals	R _{I-O}	Minimum 1000									MΩ	V _{I-O} =500 VDC, R _{oH} ≥60%	
		Typical 10 ⁸											
Turn-ON time	t _{ON}	Typical	0.8	3	3.5	1	0.6	2	0.3	ms	G3VM-61G1/63G:If=5 mA, R _L =200 Ω, V _{DD} =20 V *1 G3VM-61G2 :If=2 mA, R _L =200 Ω, V _{DD} =20 V *1 G3VM-61G3 :If=0.5 mA, R _L =200 Ω, V _{DD} =20 V *1 G3VM-61VY1:If=2 mA, R _L =200 Ω, V _{DD} =10 V *1 G3VM-61VY2/61VY3:If=5 mA, R _L =200 Ω, V _{DD} =20 V *1		
		Maximum	2	8	10	5	2	3	1				
Turn-OFF time	t _{OFF}	Typical	0.1			1		0.1		0.7	ms	G3VM-61VY1:If=2 mA, R _L =200 Ω, V _{DD} =10 V *1 G3VM-61VY2/61VY3:If=5 mA, R _L =200 Ω, V _{DD} =20 V *1	
		Maximum	0.5	3		5	0.5		3				

*1. Turn-ON and Turn-OFF Times

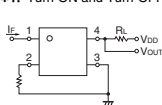

G3VM-61G1/G2/G3VY1/VY2

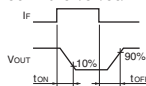

G3VM-63G

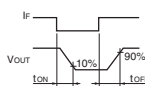

*2. These values are for Relays with NC contacts

■Recommended Operating Conditions

For usage with high reliability, Recommended Operating Conditions is a measure that takes into account the derating of Absolute Maximum Ratings and Electrical Characteristics.

Each item on this list is an independent condition, so it is not simultaneously satisfy several conditions.

Item	Symbol		G3VM-61G1	G3VM-61G2	G3VM-61G3	G3VM-61VY1	G3VM-61VY2	G3VM-61VY3	G3VM-63G	Unit	
Load voltage (AC peak/DC)	V _{DD}	Maximum	48							V	
		Minimum	5	–			2	5			
Operating LED forward current	If	Typical	7.5	2	0.5	5	7.5		–	mA	
		Maximum	25					15			25
		Maximum	400	320			80	500	700		500
Ambient operating temperature	Ta	Minimum	–20							°C	
		Maximum	65					100	85		

■Spacing and Insulation

Item	G3VM-6□G□		G3VM-61VY□		Unit
	Minimum				
Creepage distances	4.0		5.0		mm
Clearance distances	4.0		5.0		
Internal isolation thickness	0.1		0.2		

G3VM-6□G□/61VY□

MOS FET Relays

Engineering Data

LED forward current vs. Ambient temperature

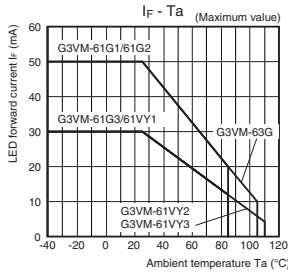

Continuous load current vs. Ambient temperature

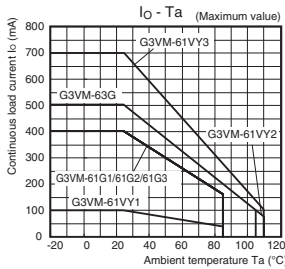

LED forward current vs. LED forward voltage

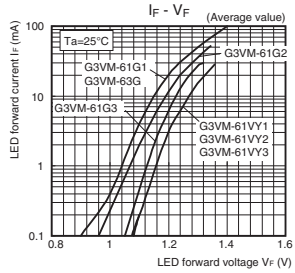

Continuous load current vs. On-state voltage

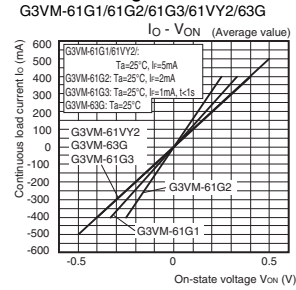

G3VM-61VY1

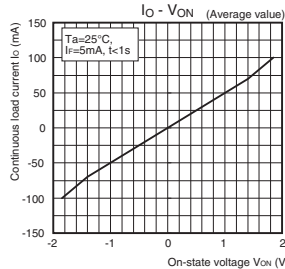

G3VM-61VY3

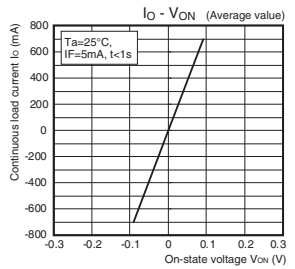

On-state resistance vs. Ambient temperature

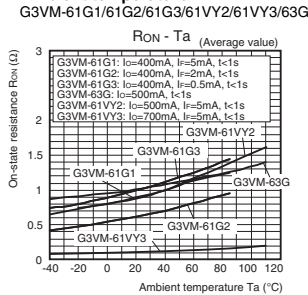

G3VM-61VY1

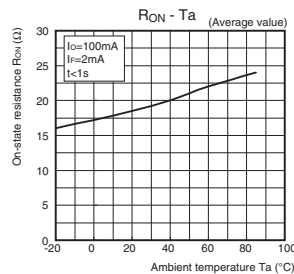

Trigger LED forward current vs. Ambient temperature

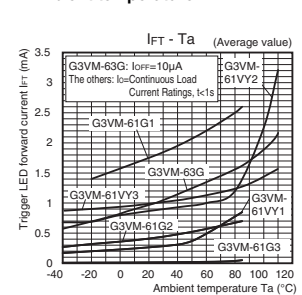

Turn ON, Turn OFF time vs. LED forward current

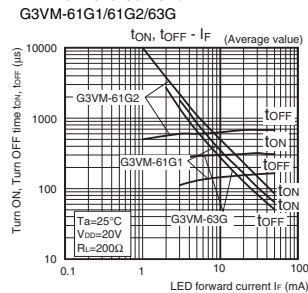

G3VM-61G3/61VY1/61VY2

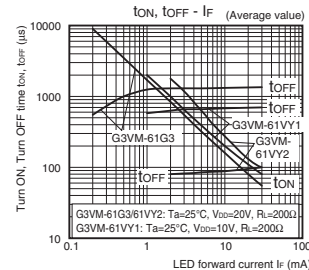

G3VM-61VY3

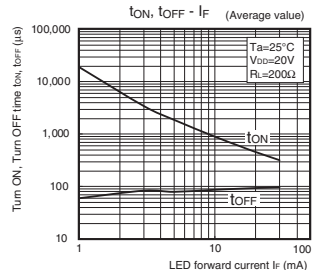

G3VM-6□G□/61VY□

MOS FET Relays

Engineering Data

● Turn ON, Turn OFF time vs. Ambient temperature

G3VM-61G1/61G2/63G/61VY2/61VY3

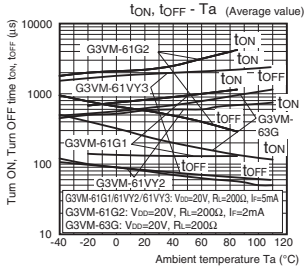

G3VM-61G3/61VY1

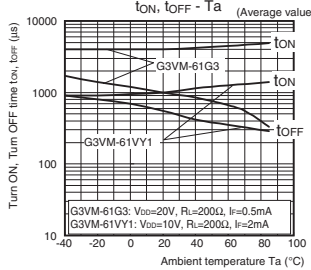

● Current leakage vs. Ambient temperature

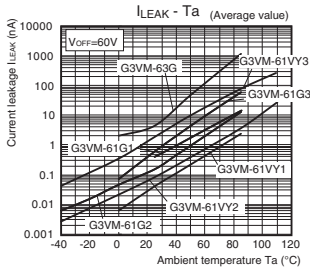

● Current leakage vs. Load voltage

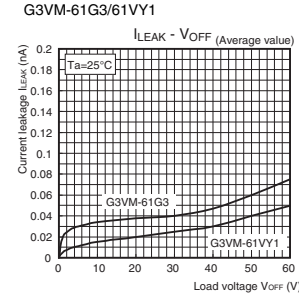

G3VM-61VY3

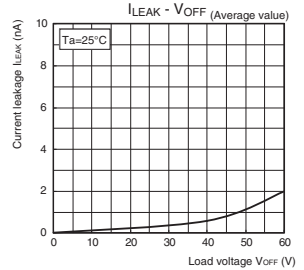

G3VM-6□G□/61VY□

MOS FET Relays

■Appearance/Terminal Arrangement/Internal Connections

●Appearance

SOP (Small Outline Package)

SOP 4-pin

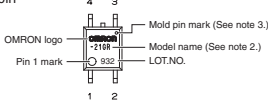

Special SOP 4-pin (G3VM-61VY1/61VY2/61VY3)

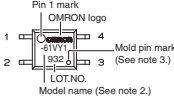

- Note 1:** The actual product is marked differently from the image shown here.
Note 2: "G3VM" does not appear in the model number on the Relay.
Note 3: The indentation in the corner diagonally opposite from the pin 1 mark is from a pin on the mold.

●Terminal Arrangement/Internal Connections (Top View)

G3VM-61G1/61G2/61G3/61VY1/61VY2/61VY3

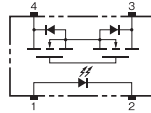

G3VM-63G

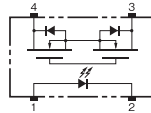

■Dimensions (Unit: mm)

SOP (Small Outline Package)

SOP 4-pin



Surface-mounting Terminals

Weight: 0.1 g

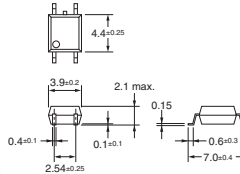

Actual Mounting Pad Dimensions

(Recommended Value, Top View)

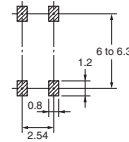

Note: The actual product is marked differently from the image shown here.

Special SOP 4-pin *(G3VM-61VY1/61VY2/61VY3)



Surface-mounting Terminals

Weight: 0.1 g

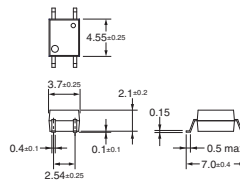

Actual Mounting Pad Dimensions

(Recommended Value, Top View)

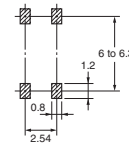

* The external dimensions are different from those of the standard SOP 4-pin, but the mounting pad dimensions are the same.
Note: The actual product is marked differently from the image shown here.

■Approved Standards

UL recognized

Model	Approved Standards	Contact form	File No.
G3VM-61G1 G3VM-61G2 G3VM-61G3 G3VM-61VY1 G3VM-61VY2 G3VM-61VY3	UL recognized	1a (SPST-NO)	E80555
G3VM-63G		1b (SPST-NC)	

■Safety Precautions

- Refer to the *Common Precautions for All MOS FET Relays* for precautions that apply to all MOS FET Relays.

G3VM-81G

MOS FET Relays SOP 4-pin, General-purpose Type

General-purpose MOS FET Relays in SOP 4-pin packages for a wide range of applications

- Load voltage: 80 V

RoHS Compliant

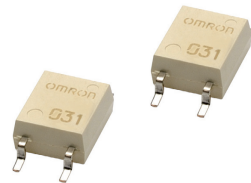

Note: The actual product is marked differently from the image shown here.

Application Examples

- Semiconductor test equipment
- Security equipment
- Amusement equipment
- Test & Measurement equipment
- Industrial equipment
- Power circuit
- Communication equipment

Package (Unit : mm, Average)

SOP 4-pin

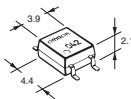

Note: The actual product is marked differently from the image shown here.

Model Number Legend

G3VM-□□□□
1 2 3 4

1. Load Voltage 2. Contact form 3. Package
8: 80 V 1: 1a (SPST-NO) G: SOP 4-pin

4. Other informations

When specifications overlap, serial code is added in the recorded order.

Ordering Information

Package	Contact form	Terminals	Load voltage (peak value) *	Continuous load current (peak value) *	Stick packaging		Tape packaging	
					Model	Minimum package quantity	Model	Minimum package quantity
SOP4	1a (SPST-NO)	Surface-mounting Terminals	80 V	350 mA	G3VM-81G1	100 pcs.	G3VM-81G1(TR)	2,500 pcs.

* The AC peak and DC value are given for the load voltage and continuous load current.

Note: To order tape packaging for Relays with surface-mounting terminals, add "(TR)" to the end of the model number.

Absolute Maximum Ratings (Ta = 25°C)

Item		Symbol	G3VM-81G1	Unit	Measurement conditions
Input	LED forward current	If	50	mA	
	LED forward current reduction rate	$\Delta I_f / ^\circ\text{C}$	-0.5	mA/°C	Ta \geq 25°C
	LED reverse voltage	V _R	5	V	
	Connection temperature	T _J	125	°C	
	Load voltage (AC peak/DC)	V _{OFF}	80	V	
Output	Continuous load current (AC peak/DC)	I _o	350	mA	
	ON current reduction rate	$\Delta I_o / ^\circ\text{C}$	-3.5	mA/°C	Ta \geq 25°C
	Pulse ON current	I _{op}	1.05	mA	t=100 ms, Duty=1/10
	Connection temperature	T _J	125	°C	
	Dielectric strength between I/O *	V _{I-O}	1500	V _{rms}	AC for 1 min
Ambient operating temperature	T _a	-20 to +85	°C		With no icing or condensation
Ambient storage temperature	T _{stg}	-40 to +125	°C		
Soldering temperature	-	260	°C		10 s

* The dielectric strength between the input and output was checked by applying voltage between all pins as a group on the LED side and all pins as a group on the light-receiving side.

G3VM-81G□

MOS FET Relays

■Electrical Characteristics (Ta = 25°C)

Item	Symbol		G3VM-81G1	Unit	Measurement conditions
LED forward voltage	VF	Minimum	1.0	V	IF=10 mA
		Typical	1.15		
		Maximum	1.3		
Reverse current	IR	Maximum	10	μA	VR=5 V
Capacitance between terminals	CT	Typical	15	pF	V=0, f=1 MHz
Trigger LED forward current	IFT	Typical	1	mA	Io=350 mA
		Maximum	4		
Release LED forward current	IFC	Minimum	0.2	mA	IOFF=10 μA
Maximum resistance with output ON	RON	Typical	1	Ω	IF=5 mA, Io=350 mA
		Maximum	1.2		
		Typical	0.2		
Current leakage when the relay is open	ILEAK	Typical	0.2	nA	Voff=30 V, Ta=50°C
		Maximum	1		
		Typical	30		
Capacitance between terminals	COFF	Maximum	40	pF	V=0, f=100 MHz
		Typical	0.8		
Capacitance between I/O terminals	CI-O	Typical	0.8	pF	f=1 MHz, VS=0V
Insulation resistance between I/O terminals	RI-O	Minimum	1000	MΩ	VI-O=500 VDC, RoH≤60%
		Typical	10 ⁹		
		Maximum	0.3		
Turn-ON time	tON	Typical	0.3	ms	IF=5 mA, RL=200 Ω, VDD=20 V *
		Maximum	0.5		
Turn-OFF time	tOFF	Typical	0.3	ms	IF=5 mA, RL=200 Ω, VDD=20 V *
		Maximum	0.5		
		Typical	0.5		

* Turn-ON and Turn-OFF Times

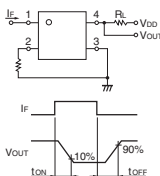

■Recommended Operating Conditions

For usage with high reliability, Recommended Operation Conditions is a measure that takes into account the derating of Absolute Maximum Ratings and Electrical Characteristics.

Each item on this list is an independent condition, so it is not simultaneously satisfy several conditions.

Item	Symbol		G3VM-81G1	Unit
Load voltage (AC peak/DC)	VDD	Maximum	64	V
		Minimum	5	
Operating LED forward current	IF	Maximum	30	mA
		Minimum	350	
Continuous load current (AC peak/DC)	Io	Maximum	350	mA
		Minimum	-20	
Ambient operating temperature	Ta	Minimum	60	°C
		Maximum	60	

■Spacing and Insulation

Item	Minimum	Unit
Creepage distances	4.0	mm
Clearance distances	4.0	
Internal isolation thickness	0.1	

Engineering Data

LED forward current vs. Ambient temperature

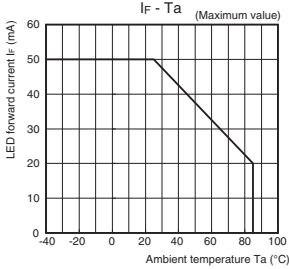

Continuous load current vs. Ambient temperature

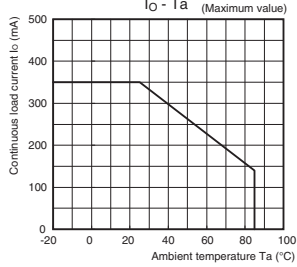

LED forward current vs. LED forward voltage

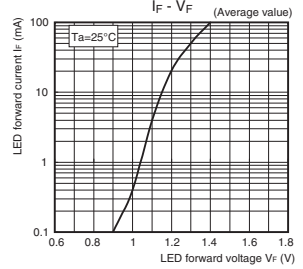

Continuous load current vs. On-state voltage

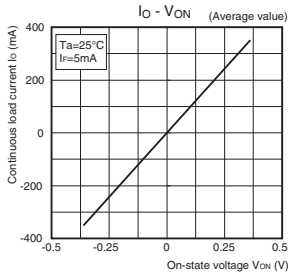

On-state resistance vs. Ambient temperature

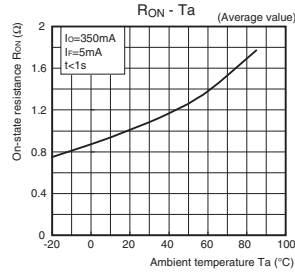

Trigger LED forward current vs. Ambient temperature

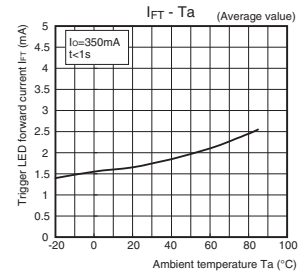

Turn ON, Turn OFF time vs. LED forward current

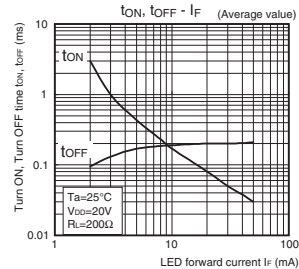

Turn ON, Turn OFF time vs. Ambient temperature

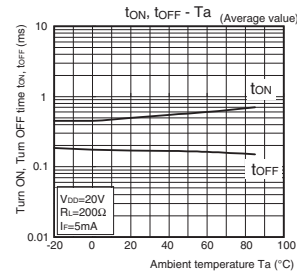

Current leakage vs. Ambient temperature

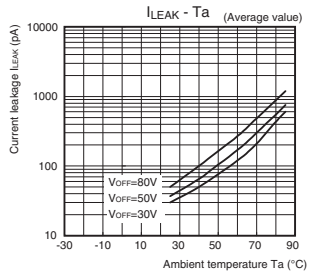

G3VM-81G□

MOS FET Relays

■ Appearance / Terminal Arrangement / Internal Connections

● Appearance

SOP (Small Outline Package)

SOP 4-pin

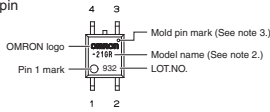
**Note 1:** The actual product is marked differently from the image shown here.**Note 2:** "G3VM" does not appear in the model number on the Relay.**Note 3:** The indentation in the corner diagonally opposite from the pin 1 mark is from a pin on the mold.

● Terminal Arrangement/Internal Connections (Top View)

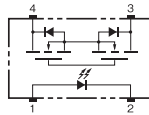

■ Dimensions (Unit: mm)



Surface-mounting Terminals

Weight: 0.1 g

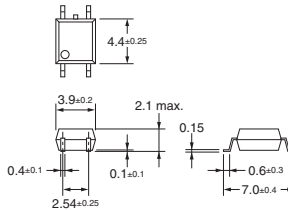

Actual Mounting Pad Dimensions

(Recommended Value, Top View)

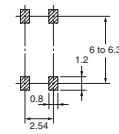
**Note:** The actual product is marked differently from the image shown here.

■ Approved Standards

UL recognized 

Approved Standards	Contact form	File No.
UL (recognized)	1a (SPST-NO)	E80555

■ Safety Precautions

- Refer to the *Common Precautions for All MOS FET Relays* for precautions that apply to all MOS FET Relays.

G3VM-201G□/S5

MOS FET Relays SOP 4-pin, General-purpose Type

General-purpose MOS FET Relays in SOP 4-pin packages for a wide range of applications

- Load voltage: 200 V



Note: The actual product is marked differently from the image shown here.

RoHS Compliant

Application Examples

- Semiconductor test equipment
- Security equipment
- Amusement equipment
- Test & Measurement equipment
- Industrial equipment
- Power circuit
- Communication equipment

Package

(Unit : mm, Average)

SOP 4-pin

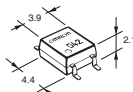

Note: The actual product is marked differently from the image shown here.

Model Number Legend

G3VM-□□□□
1 2 3 4

1. Load Voltage
20 : 200 V
2. Contact form
1 : 1a (SPST-NO)
3. Package
G : SOP 4-pin

4. Other informations

When specifications overlap, serial code is added in the recorded order.

Note: The model number legend for the G3VM-S5 is different from the above legend.

Ordering Information

Package	Contact form	Terminals	Load voltage (peak value) *	Continuous load current (peak value) *	Stick packaging		Tape packaging	
					Model	Minimum package quantity	Model	Minimum package quantity
SOP4	1a (SPST-NO)	Surface-mounting Terminals	200 V	50 mA	G3VM-201G	100 pcs.	G3VM-201G(TR)	2,500 pcs.
				200 mA	G3VM-201G1		G3VM-201G1(TR)	
					G3VM-201G2		G3VM-201G2(TR)	
					G3VM-S5		G3VM-S5(TR)	

* The AC peak and DC value are given for the load voltage and continuous load current.

Note: To order tape packaging for Relays with surface-mounting terminals, add "(TR)" to the end of the model number.

Absolute Maximum Ratings (Ta = 25°C)

Item		Symbol	G3VM-201G	G3VM-201G1	G3VM-201G2	G3VM-S5	Unit	Measurement conditions
Input	LED forward current	IF	50		30	50	mA	
	Repetitive peak LED forward current	IFP	1				A	100 μs pulses, 100 pps
	LED forward current reduction rate	ΔIf/°C	-0.5		-0.3	-0.5	mA/°C	Ta ≥ 25°C
	LED reverse voltage	VR	5				V	
	Connection temperature	TJ	125				°C	
Output	Load voltage (AC peak/DC)	V _{OFF}	200				V	
	Continuous load current (AC peak/DC)	Io	50		200		mA	
	ON current reduction rate	ΔIo/°C	-0.5		-2		mA/°C	Ta ≥ 25°C
	Pulse ON current	Iop	150		600		mA	t=100 ms, Duty=1/10
	Connection temperature	TJ	125				°C	
	Dielectric strength between I/O *	V _{IO}	1500				Vrms	AC for 1 min
	Ambient operating temperature	Ta	-40 to +85				°C	With no icing or condensation
	Ambient storage temperature	Tstg	-55 to +125				°C	
	Soldering temperature	-	260				°C	10 s

* The dielectric strength between the input and output was checked by applying voltage between all pins as a group on the LED side and all pins as a group on the light-receiving side.

G3VM-201G□/S5

MOS FET Relays

■Electrical Characteristics (Ta = 25°C)

Item	Symbol		G3VM-201G	G3VM-201G1	G3VM-201G2	G3VM-S5	Unit	Measurement conditions
LED forward voltage	V _F	Minimum	1.0		1.1	1.0	V	I _F =10 mA
		Typical	1.15		1.27	1.15		
		Maximum	1.3		1.4	1.3		
Reverse current	I _R	Maximum	10				μA	V _R =5 V
Capacitance between terminals	C _T	Typical	30				pF	V=0, f=1 MHz
Trigger LED forward current	I _{FT}	Typical	1	0.4	–	1	mA	G3VM-201G : I _o =50 mA G3VM-201G1/201G2/S5 : I _o =200 mA
		Maximum	3	1	0.2	3		
Release LED forward current	I _{FC}	Minimum	0.1			0.1	mA	I _{OFF} =100 μA
		Typical	–			0.001		
Maximum resistance with output ON	R _{ON}	Typical	40	5			Ω	G3VM-201G/S5 : I _F =5 mA, I _o =Continuous load current ratings G3VM-201G1 : I _F =2 mA, I _o =200 mA G3VM-201G2 : I _F =0.5 mA, I _o =200 mA, t < 1s
		Maximum	50	8				
Current leakage when the relay is open	I _{LEAK}	Typical	–	1		–	nA	G3VM-201G : V _{OFF} =160 V G3VM-201G1/201G2/S5 : V _{OFF} =200 V
		Maximum	1	1,000				
Capacitance between terminals	C _{OFF}	Typical	15	90		100	pF	G3VM-201G : V=0, f=1 MHz, t < 10s G3VM-201G1/201G2/S5 : V=0, f=1 MHz
		Maximum	20	–				
Capacitance between I/O terminals	C _{I-O}	Typical	0.8				pF	f=1 MHz, V _s =0 V
Insulation resistance between I/O terminals	R _{I-O}	Minimum	1000				MΩ	V _{I-O} =500 VDC, RoHS=60%
		Typical	10 ⁹					
Turn-ON time	t _{ON}	Typical	–	3	3.5	0.6	ms	G3VM-201G/S5 : I _F =5 mA, R _L =200 Ω, V _{DD} =20 V * G3VM-201G1 : I _F =2 mA, R _L =200 Ω, V _{DD} =20 V * G3VM-201G2 : I _F =0.5 mA, R _L =200 Ω, V _{DD} =20 V *
		Maximum	0.5	8	10	1.5		
Turn-OFF time	t _{OFF}	Typical	–	0.6	1	0.1	ms	G3VM-201G2 : I _F =0.5 mA, R _L =200 Ω, V _{DD} =20 V *
		Maximum	0.2	3	5	1		

* Turn-ON and Turn-OFF Times

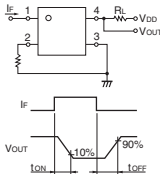

■Recommended Operating Conditions

For usage with high reliability, Recommended Operation Conditions is a measure that takes into account the derating of Absolute Maximum Ratings and Electrical Characteristics.

Each item on this list is an independent condition, so it is not simultaneously satisfy several conditions.

Item	Symbol		G3VM-201G	G3VM-201G1	G3VM-201G2	G3VM-S5	Unit	
Load voltage (AC peak/DC)	V _{DD}	Maximum	160				200	V
		Minimum	5	–		5		
Operating LED forward current	I _F	Typical	7.5	2	0.5	7.5	mA	
		Maximum	15	25				
Continuous load current (AC peak/DC)	I _o	Maximum	40	160		130		
Ambient operating temperature	T _a	Minimum	-20				°C	
		Maximum	65					

■Spacing and Insulation

Item	Minimum	Unit
Creepage distances	4.0	mm
Clearance distances	4.0	
Internal isolation thickness	0.1	

Engineering Data

LED forward current vs. Ambient temperature

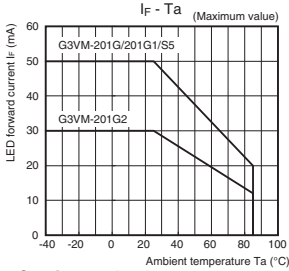

Continuous load current vs. On-state voltage

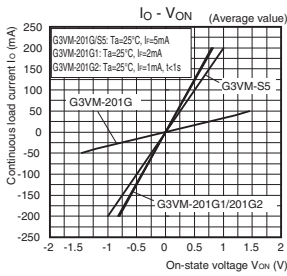

Trigger LED forward current vs. Ambient temperature

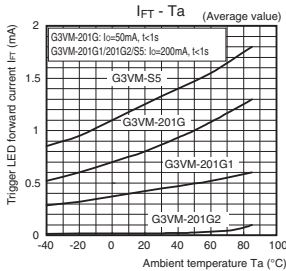

Continuous load current vs. Ambient temperature

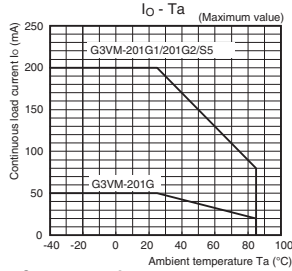

On-state resistance vs. Ambient temperature

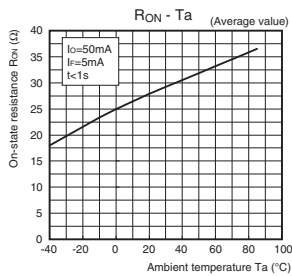

Turn ON, Turn OFF time vs. LED forward current

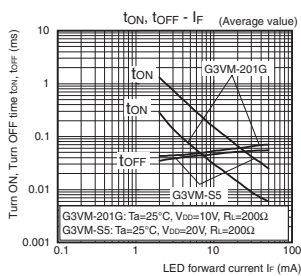

LED forward current vs. LED forward voltage

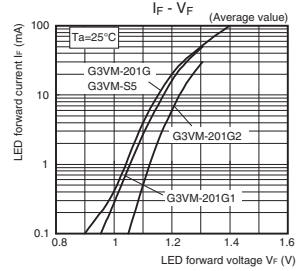

G3VM-201G1/201G2/S5

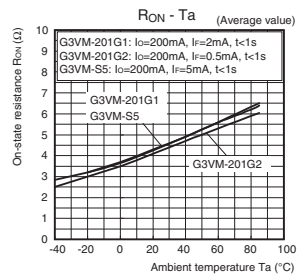

G3VM-201G1/201G2

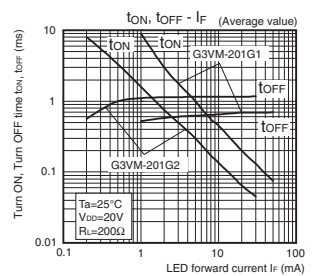

Engineering Data

● Turn ON, Turn OFF time vs. Ambient temperature G3VM-201G/S5

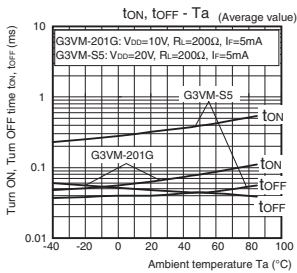

● Current leakage vs. Load voltage G3VM-201G2

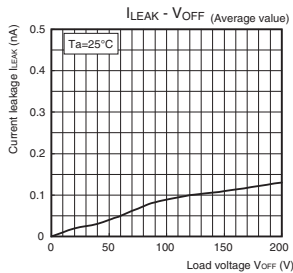

G3VM-201G1/201G2

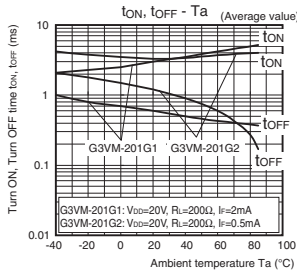

● Current leakage vs. Ambient temperature

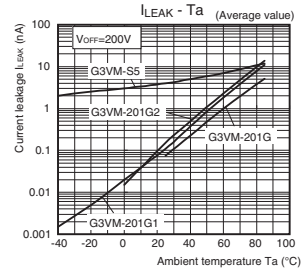

G3VM-201G□/S5

MOS FET Relays

■ Appearance / Terminal Arrangement / Internal Connections

● Appearance

SOP (Small Outline Package)

SOP 4-pin

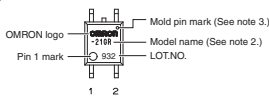
**Note 1.** The actual product is marked differently from the image shown here.**Note 2.** "G3VM" does not appear in the model number on the Relay.**Note 3.** The indentation in the corner diagonally opposite from the pin 1 mark is from a pin on the mold.

● Terminal Arrangement/Internal Connections (Top View)

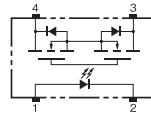

■ Dimensions (Unit: mm)



Surface-mounting Terminals

Weight: 0.1 g

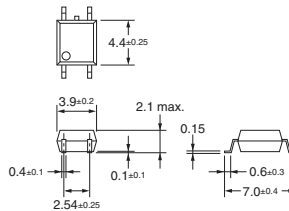

Actual Mounting Pad Dimensions

(Recommended Value, Top View)

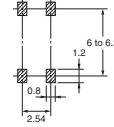
**Note:** The actual product is marked differently from the image shown here.

■ Approved Standards

UL recognized 

Approved Standards	Contact form	File No.
UL (recognized)	1a (SPST-NO)	E80555

■ Safety Precautions

- Refer to the *Common Precautions for All MOS FET Relays* for precautions that apply to all MOS FET Relays.

G3VM-35□G□/351VY/401G□

MOS FET Relays SOP 4-pin, General-purpose Type

General-purpose MOS FET Relays in SOP 4-pin packages for a wide range of applications

- Contact form: 1a (SPST-NO) or 1b (SPST-NC)
- Load voltage: 350 V or 400 V

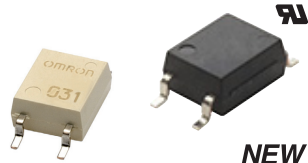

NEW

Note: The actual product is marked differently from the image shown here.

RoHS Compliant

Application Examples

- Semiconductor test equipment
- Test & Measurement equipment
- Communication equipment
- Various battery-driven devices
- Security equipment
- Industrial equipment
- Power circuit
- Amusement equipment

Package

(Unit : mm, Average)

SOP 4-pin

Special SOP 4-pin

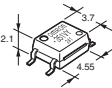
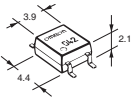

Note: The actual product is marked differently from the image shown here.

Model Number Legend

G3VM-□□□□□
1 2 3 4 5

- Load Voltage**
35 : 350 V
40 : 400 V
- Contact form**
1 : 1a (SPST-NO)
3 : 1b (SPST-NC)

- Package**
G : SOP 4-pin
V : Special SOP 4-pin

4. Additional functions

None: Dielectric strength between I/O 1500 V
Y: Dielectric strength between I/O 3750 V

5. Other informations

When specifications overlap, serial code is added in the recorded order.

Ordering Information

Package	Contact form	Terminals	Load voltage (peak value) *	Continuous load current (peak value) *	Stick packaging		Tape packaging	
					Model	Minimum package quantity	Model	Minimum package quantity
SOP4	1a (SPST-NO)	Surface-mounting Terminals	350 V	100 mA	G3VM-351G1	100 pcs.	G3VM-351G1(TR)	2,500 pcs.
					G3VM-351G		G3VM-351G(TR)	
Special SOP 4-PIN	1b (SPST-NC)			110 mA	G3VM-351VY	125 pcs.	G3VM-351VY(TR05)	500 pcs.
							G3VM-351VY(TR)	3,000 pcs.
SOP4	1a (SPST-NO)		400 V	120 mA	G3VM-353G	100 pcs.	G3VM-353G(TR)	2,500 pcs.
				100 mA	G3VM-401G1		G3VM-401G1(TR)	
				120 mA	G3VM-401G	G3VM-401G(TR)		

* The AC peak and DC value are given for the load voltage and continuous load current.

Note: To order tape packaging for Relays with surface-mounting terminals, add "(TR)" , "(TR05)" to the end of the model number.

Absolute Maximum Ratings (Ta = 25°C)

Item	Symbol	G3VM-351G1	G3VM-351G	G3VM-351VY	G3VM-353G	G3VM-401G1	G3VM-401G	Unit	Measurement conditions
LED forward current	If	50	30	50	30	50	30	mA	
LED forward current reduction rate	ΔIf/°C	-0.5	-0.3	-0.5	-0.3	-0.5	-0.3	mA/°C	Ta ≥ 25°C
LED reverse voltage	Vr	5	6	5	5	5	5	V	
Connection temperature	Tj	125						°C	
Load voltage (AC peak/DC)	Voff	350			400			V	
Continuous load current (AC peak/DC)	Io	100	110	120	100	120	120	mA	
ON current reduction rate	ΔIo/°C	-1.0	-1.1	-1.2	-1.0	-1.2	-1.2	mA/°C	Ta ≥ 25°C
Pulse ON current	Iop	300	330	360	300	360	360	mA	t=100 ms, Duty=1/10
Connection temperature	Tj	125						°C	
Dielectric strength between I/O *	Vi-o	1500	3750	1500	1500	1500	1500	Vrms	AC for 1 min
Ambient operating temperature	Ta	-40 to +85	-40 to +110	-40 to +85	-40 to +85	-40 to +85	-40 to +85	°C	With no icing or condensation
Ambient storage temperature	Tstg	-55 to +125						°C	
Soldering temperature	-	260						°C	10 s

* The dielectric strength between the input and output was checked by applying voltage between all pins as a group on the LED side and all pins as a group on the light-receiving side.

G3VM-35□G□/351VY/401G□

MOS FET Relays

■Electrical Characteristics (Ta = 25°C)

Item	Symbol		G3VM-351G1	G3VM-351G	G3VM-351VY	G3VM-353G	G3VM-401G1	G3VM-401G	Unit	Measurement conditions
LED forward voltage	V _F	Minimum	1.0		1.1	1.0	1.1	1.0	V	I _F =10 mA
		Typical	1.15		1.27	1.15	1.27	1.15		
		Maximum	1.3		1.4	1.3	1.4	1.3		
Reverse current	I _R	Maximum	10						μA	V _R =5 V
Capacitance between terminals	C _T	Typical	30						pF	V=0, f=1 MHz
Trigger LED forward current	I _{FT} (I _{FC}) #2	Typical	0.4	1	0.8	1	–	1	mA	G3VM-351G1/351G/401G1 : I _o =100 mA G3VM-351VY : I _o =110 mA G3VM-353G : I _{oFF} =10 μA G3VM-401G : I _o =120 mA
		Maximum	1		3		0.2	3		
Release LED forward current	I _{FC} (I _{FT}) #2	Minimum	0.1			–	–	0.1	mA	G3VM-351G1/351VY/351G/401G1/401G : I _{oFF} =100 μA G3VM-353G : I _o =120 mA
		Typical	–		0.4	–	0.001	–		
Maximum resistance with output ON	R _{ON}	Typical	35 (25)		35 (22)	15	18	17	Ω	G3VM-351G1 : I _F =2 mA, I _o =100 mA Values in parentheses are for t < 1 s. G3VM-351G : I _F =5 mA, I _o =110 mA Values in parentheses are for t < 1 s. G3VM-351VY : I _F =5 mA, I _o =110 mA Values in parentheses are for t < 1 s. G3VM-353G : I _o =120 mA G3VM-401G1 : I _F =0.5 mA, I _o =100 mA, t < 1 s G3VM-401G : I _F =5 mA, I _o =120 mA
		Maximum	50 (35)			25		35		
Current leakage when the relay is open	I _{LEAK}	Typical	1	–	1	–	1	–	nA	G3VM-351G1/351VY/351G : V _{oFF} =350 V G3VM-353G : V _{oFF} =350 V, I _F =5 mA G3VM-401G1/401G : V _{oFF} =400 V
		Maximum	1,000							
Capacitance between terminals	C _{OFF}	Typical	35	30	30	65	70		pF	G3VM-351G1/351VY/351G/401G1/401G : V=0, f=1 MHz G3VM-353G : V=0, f=1 MHz, I _F =5 mA
Capacitance between I/O terminals	C _{I-O}	Typical	0.8						pF	f=1 MHz, V _S =0 V
Insulation resistance between I/O terminals	R _{I-O}	Minimum	1000						MΩ	V _{I-O} =500 VDC, RoH≤60%
		Typical	10 ⁸							
Turn-ON time	t _{ON}	Typical	1	0.3	0.5	–	2	0.3	ms	G3VM-351G1 : I _F =2 mA, R _L =200 Ω, V _{DD} =20 V G3VM-401G1 : I _F =0.5 mA, R _L =200 Ω, V _{DD} =20 V Others : I _F =5 mA, R _L =200 Ω, V _{DD} =20 V #1
		Maximum	5		1		10	1		
Turn-OFF time	t _{OFF}	Typical	1		0.1	–	1	0.1	ms	G3VM-351G1 : I _F =0.5 mA, R _L =200 Ω, V _{DD} =20 V Others : I _F =5 mA, R _L =200 Ω, V _{DD} =20 V #1
		Maximum	3	1	0.5	3	5	1		

*1. Turn-ON and Turn-OFF Times

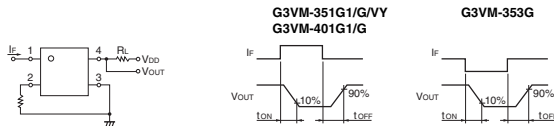

*2. These values are for Relays with NC contacts

■Recommended Operating Conditions

For usage with high reliability, Recommended Operation Conditions is a measure that takes into account the derating of Absolute Maximum Ratings and Electrical Characteristics.

Each item on this list is an independent condition, so it is not simultaneously satisfy several conditions.

Item	Symbol		G3VM-351G1	G3VM-351G	G3VM-351VY	G3VM-353G	G3VM-401G1	G3VM-401G	Unit	
Load voltage (AC peak/DC)	V _{DD}	Maximum	280						320	V
Operating LED forward current	I _F	Minimum	–						5	mA
		Typical	2		7.5		–		7.5	
		Maximum	25						0.5	
Continuous load current (AC peak/DC)	I _o	Maximum	80	100	110	120	80	120	mA	
		Minimum	–20							
Ambient operating temperature	T _a	Minimum	–20						°C	
		Maximum	65		100		65			

■Spacing and Insulation

Item	G3VM-35□G□/401G□		G3VM-351VY		Unit
	Minimum				
Creepage distances	4.0		5.0		mm
Clearance distances	4.0		5.0		
Internal isolation thickness	0.1		0.2		

G3VM-35□G□/351VY/401G□

MOS FET Relays

Engineering Data

● LED forward current vs. Ambient temperature

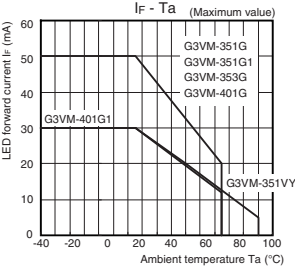

● Continuous load current vs. Ambient temperature

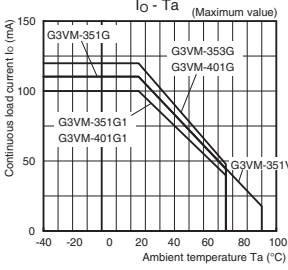

● LED forward current vs. LED forward voltage

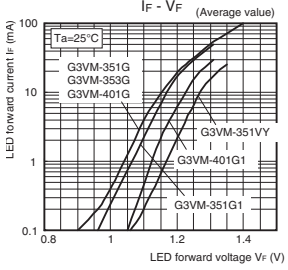

● Continuous load current vs. On-state voltage

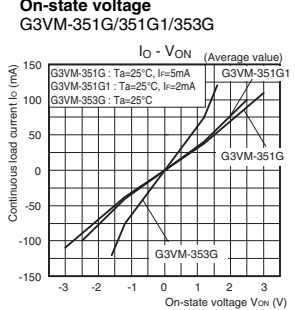

G3VM-351VY/401G/401G1

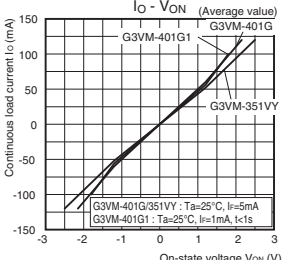

● On-state resistance vs. Ambient temperature

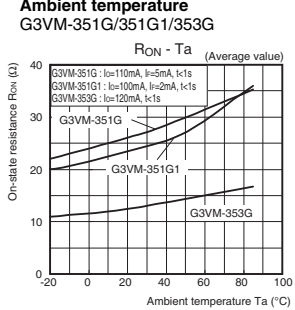

G3VM-351VY/401G/401G1

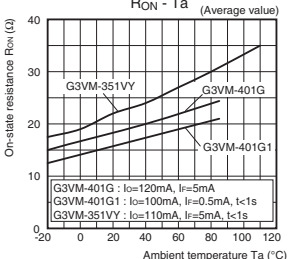

● Trigger LED forward current vs. Ambient temperature

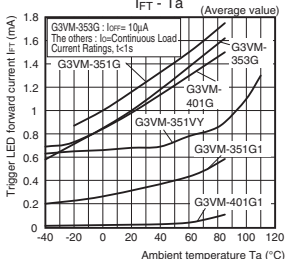

● Turn ON, Turn OFF time vs. LED forward current

G3VM-351G/351G1/353G

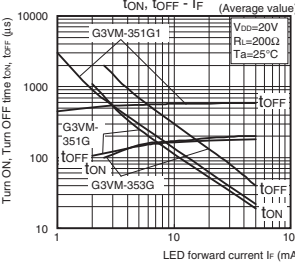

G3VM-351VY/401G/401G1

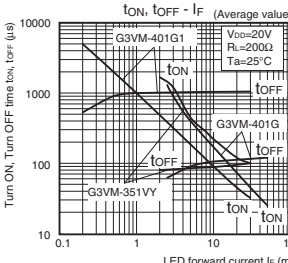

G3VM-35□G□/351VY/401G□

MOS FET Relays

Engineering Data

● **Turn ON, Turn OFF time vs. Ambient temperature**
G3VM-351G/351G1/353G

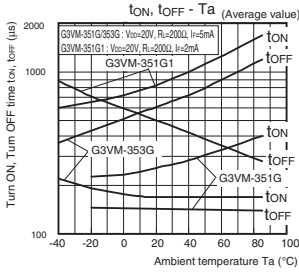

● **Current leakage vs. Load voltage**

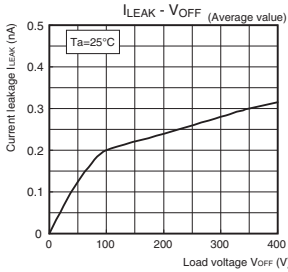

G3VM-351VY/401G/401G1

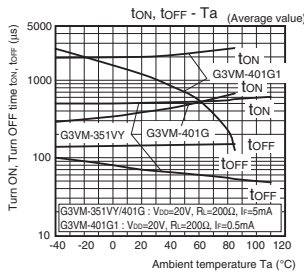

● **Current leakage vs. Ambient temperature**

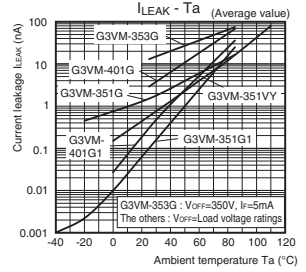

Introduction
General purpose
High-level-voltage
Multi-contact pair (2a, 2b, and 1a1)
High-current and inductive strength
Small and high-inductive strength
High-dielectric strength
Current-limiting
Low-voltage and low-resistance
Small and High-voltage
Certified Models with Standards Certification
DIP
SOP
SSOP
USOP
VSON
S-VSON
G3VM-35□G□/351VY/401G□

G3VM-35□G□/351VY/401G□

MOS FET Relays

■ Appearance / Terminal Arrangement / Internal Connections

● Appearance

SOP (Small Outline Package)

SOP 4-pin

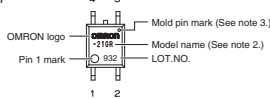

Special SOP 4-pin (G3VM-351VY)

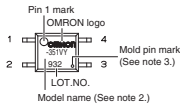
**Note:** 1. The actual product is marked differently from the image shown here.**Note:** 2. "G3VM" does not appear in the model number on the Relay.**Note:** 3. The indentation in the corner diagonally opposite from the pin 1 mark is from a pin on the mold.

● Terminal Arrangement/Internal Connections (Top View)

G3VM-351G1/G/VY

G3VM-401G1/G

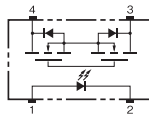

G3VM-353G

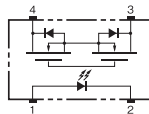

■ Dimensions (Unit: mm)

SOP (Small Outline Package)

SOP 4-pin



Surface-mounting Terminals

Weight: 0.1 g

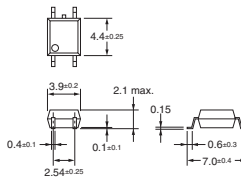

Actual Mounting Pad Dimensions

(Recommended Value, Top View)

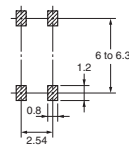
**Note:** The actual product is marked differently from the image shown here.

Special SOP 4-pin * (G3VM-351VY)



Surface-mounting Terminals

Weight: 0.1 g

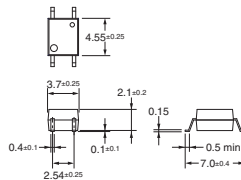

Actual Mounting Pad Dimensions

(Recommended Value, Top View)

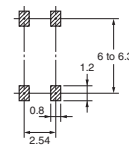

* The external dimensions are different from those of the standard SOP 4-pin, but the mounting pad dimensions are the same.

Note: The actual product is marked differently from the image shown here.

■ Approved Standards

UL recognized



Model	Approved Standards	Contact form	File No.
G3VM-351G1 G3VM-351G G3VM-401G G3VM-351VY	UL (recognized)	1a (SPST-NO)	E80555
G3VM-353G G3VM-401G1		1b (SPST-NC)	
UL certification is pending.			

Models Certified by BSI for EN/IEC Standards

Model	Approved Standards	Contact form	File No.
G3VM-401G	EN62368-1 (BSI certified)	1a (SPST-NO)	VC669262

G3VM-35□G□/351VY/401G□

MOS FET Relays

■Safety Precautions

- Refer to the *Common Precautions for All MOS FET Relays* for precautions that apply to all MOS FET Relays.

G3VM-□□H□

MOS FET Relays SOP 6-pin, General-purpose Type

General-purpose MOS FET Relays in SOP 6-pin packages for a wide range of applications

- Contact form: 1a (SPST-NO) or 1b (SPST-NC)
- Load voltage: 60 V, 200 V, 350 V, or 400 V

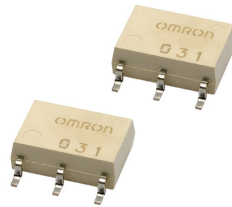

Note: The actual product is marked differently from the image shown here.

RoHS Compliant

Application Examples

- Semiconductor test equipment
- Security equipment
- Amusement equipment
- Communication equipment
- Industrial equipment
- Test & Measurement equipment
- Power circuit

Package

(Unit : mm, Average)

SOP 6-pin

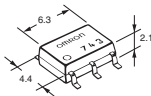

Note: The actual product is marked differently from the image shown here.

Model Number Legend

G3VM-□□□□
1 2 3 4

1. Load Voltage

6 : 60 V
20 : 200 V
35 : 350 V
40 : 400 V

2. Contact form

1 : 1a (SPST-NO)
3 : 1b (SPST-NC)

3. Package

H : SOP 6-pin

4. Other informations

When specifications overlap, serial code is added in the recorded order.

Ordering Information

Package	Contact form	Terminals	Load voltage (peak value) *	Continuous load current (peak value) *		Stick packaging		Tape packaging	
				Connection A, B	Connection C	Model	Minimum package quantity	Model	Minimum package quantity
SOP6	1a (SPST-NO)	Surface-mounting Terminals	60 V	400 mA	800 mA	G3VM-61H1	75 pcs.	G3VM-61H1(TR)	2,500 pcs.
			200 V	200 mA	400 mA	G3VM-201H1		G3VM-201H1(TR)	
	350 V		110 mA	220 mA	G3VM-351H	G3VM-351H(TR)			
			400 V	120 mA	240 mA	G3VM-353H		G3VM-353H(TR)	
G3VM-401H	G3VM-401H(TR)								

* The AC peak and DC value are given for the load voltage and continuous load current.

Note: To order tape packaging for Relays with surface-mounting terminals, add "(TR)" to the end of the model number.

■Absolute Maximum Ratings (Ta = 25°C)

Item		Symbol	G3VM-61H1	G3VM-201H1	G3VM-351H	G3VM-353H	G3VM-401H	Unit	Measurement conditions	
Input	LED forward current	I _F	50						mA	
	LED forward current reduction rate	$\Delta I_F/\text{°C}$	-0.5						mA/°C	Ta ≥ 25°C
	LED reverse voltage	V _R	5						V	
	Connection temperature	T _J	125						°C	
Load voltage (AC peak/DC)		V _{OFF}	60	200	350		400	V		
Output	Continuous load current	Connection A	I _o	400	200	110	120	mA	Connection A: AC peak/DC Connection B and C: DC	
		Connection B		800	400	220	240			
		Connection C								
	ON current reduction rate	Connection A	$\Delta I_o/\text{°C}$	-4.0	-2.0	-1.1	-1.2	mA/°C	Ta ≥ 25°C	
		Connection B Connection C		-8.0	-4.0	-2.2	-2.4			
Pulse ON current		I _{op}	1200	600	330	360	mA	t=100 ms, Duty=1/10		
Connection temperature		T _J	125						°C	
Dielectric strength between I/O *		V _{i-o}	1500						V _{rms}	AC for 1 min
Ambient operating temperature		T _a	-40 to +85						°C	With no icing or condensation
Ambient storage temperature		T _{stg}	-55 to +125						°C	
Soldering temperature		—	260						°C	10 s

* The dielectric strength between the input and output was checked by applying voltage between all pins as a group on the LED side and all pins as a group on the light-receiving side.

Connection Diagram

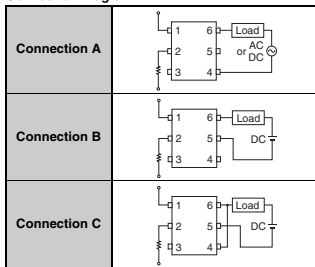

Electrical Characteristics (Ta = 25°C)

Item		Symbol	G3VM-61H1	G3VM-201H1	G3VM-351H	G3VM-353H	G3VM-401H	Unit	Measurement conditions	
Input	LED forward voltage	V _F	Minimum					V	I _F =10 mA	
			1.0							
			Typical							
	1.15									
	Maximum									
1.3										
Reverse current	I _R	Maximum	10					μA	V _R =5 V	
			30							
Capacitance between terminals	C _T	Typical	30					pF	V=0, f=1 MHz	
Trigger LED forward current	I _{FT} (I _{FC}) *2	Typical	1.6	1				mA	G3VM-61H1/201H1/351H/401H : I _o =Continuous load current ratings G3VM-353H : I _{oFF} =10 μA	
			Maximum							
3										
Release LED forward current	I _{FC} (I _{FT}) *2	Minimum	0.1					mA	G3VM-61H1/201H1/351H/401H : I _{oFF} =100 μA G3VM-353H : I _o =120 mA	
Output	Maximum resistance with output ON	R _{ON}	Typical	1	5	35 (25)	15	17	Ω	G3VM-61H1/201H1/351H/401H : I _F =5 mA, I _o =Continuous load current ratings Values in parentheses are for t < 1 s. G3VM-353H : I _o =Continuous load current ratings
				0.5						
				3						
			2.5							
			1.5							
			14							
Maximum	2									
	8									
	50 (35)									
25										
35										
1										
5										
40										
14										
20										
-										
20										
-										
Current leakage when the relay is open	I _{LEAK}	Maximum	1					μA	G3VM-61H1/201H1/351H/401H : V _{OFF} =Load voltage ratings G3VM-353H : V _{OFF} =350 V, I _F =5 mA	
Capacitance between terminals	C _{OFF}	Typical	130	100	30	65	70	pF	G3VM-61H1/201H1/351H/401H : V=0, f=1 MHz G3VM-353H : V=0, f=1 MHz, I _F =5 mA	
Capacitance between I/O terminals	C _{I-O}	Typical	0.8					pF	f=1 MHz, V _S =0 V	
Insulation resistance between I/O terminals	R _{I-O}	Minimum	1000					MΩ	V _{I-O} =500 VDC, RoHS60%	
		Typical	10 ⁸							
Turn-ON time	t _{ON}	Typical	0.8	0.6	0.3	-	0.3	ms	I _F =5 mA, R _L =200 Ω, V _{DD} =20 V *1	
		Maximum	2		1.5		1			
Turn-OFF time	t _{OFF}	Typical	0.1		-		0.1	ms	I _F =5 mA, R _L =200 Ω, V _{DD} =20 V *1	
		Maximum	0.5	1		3	1			

*1. Turn-ON and Turn-OFF Times

*2. These values are for Relays with NC contacts

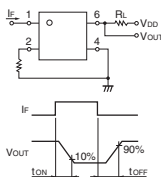

Recommended Operating Conditions

For usage with high reliability, Recommended Operation Conditions is a measure that takes into account the derating of Absolute Maximum Ratings and Electrical Characteristics.

Each item on this list is an independent condition, so it is not simultaneously satisfy several conditions.

Item	Symbol	G3VM-61H1	G3VM-201H1	G3VM-351H	G3VM-353H	G3VM-401H	Unit	
Load voltage (AC peak/DC)	V _{DD}	Maximum	48	160	280	320	V	
		Minimum	5					
Operating LED forward current	I _F	Typical	7.5			10	7.5	mA
		Maximum	25					
		Minimum	-					
Continuous load current (AC peak/DC)	I _o	Maximum	400	130	100	120	mA	
		Minimum	-					
Ambient operating temperature	T _a	Minimum	-					°C
		Maximum	65	60	65			

Spacing and Insulation

Item	Minimum	Unit
Creepage distances	4.0	mm
Clearance distances	4.0	
Internal isolation thickness	0.1	

Engineering Data

● **LED forward current vs. Ambient temperature**

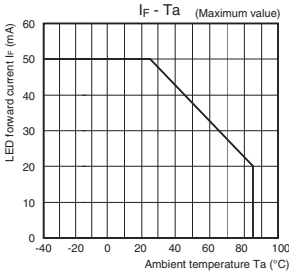

● **LED forward current vs. LED forward voltage**

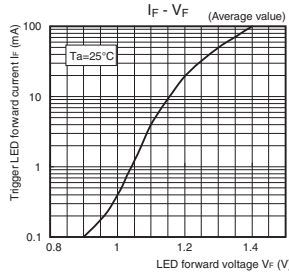

● **On-state resistance vs. Ambient temperature**
G3VM-61H1/201H1

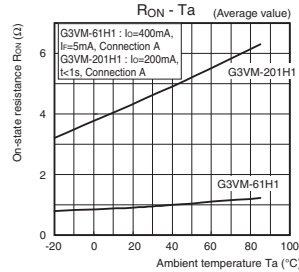

● **Continuous load current vs. Ambient temperature**
G3VM-61H1/201H1

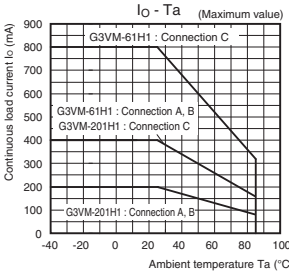

● **Continuous load current vs. On-state voltage**
G3VM-61H1/201H1

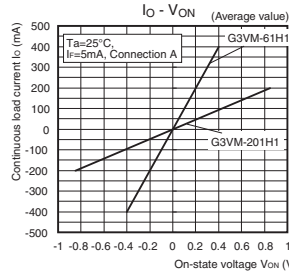

G3VM-351H/353H/401H

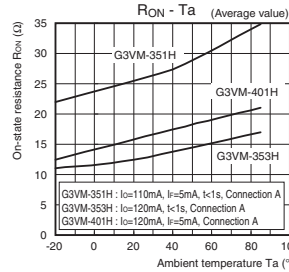

G3VM-351H/353H/401H

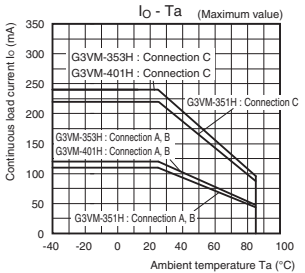

G3VM-351H/353H/401H

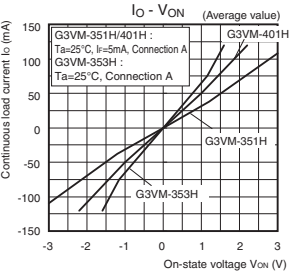

● **Trigger LED forward current vs. Ambient temperature**

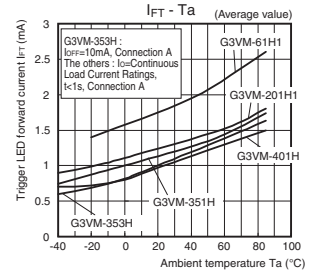

Introduction
 General purpose
 High-side-voltage
 Multi-contact pair
 High-current and low-ON-resistance
 Small and high-inductive-strength
 High-dielectric-strength
 Current-limiting
 Low-on-state-resistance and low-ON-resistance
 Small lead and High-voltage
 Certified Models with Standards Derivation
 DIP
 SOP
 SSOP
 USOP
 VSON
 S-VSON
 G3VM-□□□

G3VM-□□□

MOS FET Relays

Engineering Data

● Turn ON, Turn OFF time vs. LED forward current
G3VM-61H1/201H1

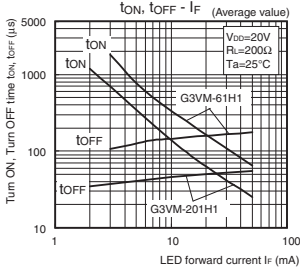

G3VM-351H/353H/401H

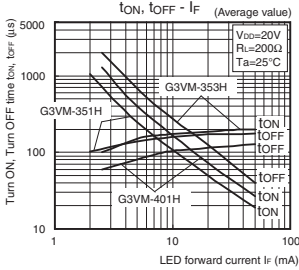

● Turn ON, Turn OFF time vs. Ambient temperature
G3VM-61H1/201H1

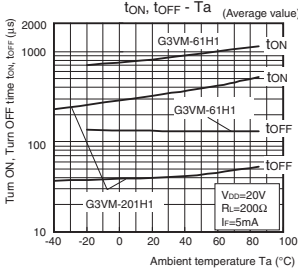

G3VM-351H/353H/401H

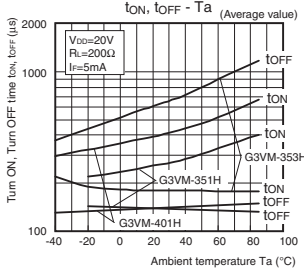

● Current leakage vs. Ambient temperature

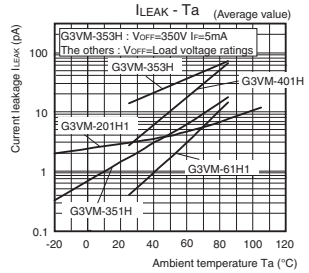

Introduction
General purpose
High-voltage
Multi-conductors (2A, 2A, and 1A)
High-current and low-on-resistance
Small and high-inductive strength
High-dielectric strength
Current-limiting
Low-on-capacitance and low-on-resistance
Small and High-load-voltage
Certified models with Solder certification
DIP
SOP
SSOP
USOP
VSON
S-VSON

G3VM-□□□

■ Appearance / Terminal Arrangement / Internal Connections

● Appearance

SOP (Small Outline Package)

SOP 6-pin

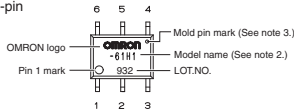

- Note:** 1. The actual product is marked differently from the image shown here.
Note: 2. "G3VM" does not appear in the model number on the Relay.
Note: 3. The indentation in the corner diagonally opposite from the pin 1 mark is from a pin on the mold.

● Terminal Arrangement/Internal Connections (Top View)

G3VM-61H1/201H1/351H/401H

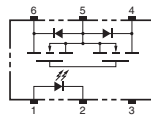

G3VM-353H

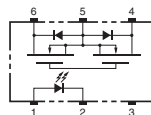

■ Dimensions (Unit: mm)



Surface-mounting Terminals

Weight: 0.13 g

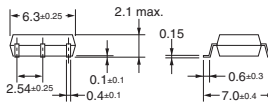
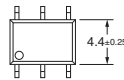

Actual Mounting Pad Dimensions

(Recommended Value, Top View)

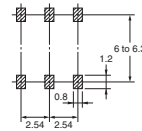

Note: The actual product is marked differently from the image shown here.

■ Approved Standards

UL recognized 

Model	Approved Standards	Contact form	File No.
G3VM-61H1 G3VM-201H1 G3VM-351H	UL (recognized)	1a (SPST-NO)	E80555
G3VM-353H		1b (SPST-NC)	
G3VM-401H		1a (SPST-NO)	

Models Certified by BSI for EN/IEC Standards

Model	Approved Standards	Contact form	File No.
G3VM-401H	EN 60950/EN 60065 (BSI certified)	1a (SPST-NO)	8884 8885

■ Safety Precautions

- Refer to the *Common Precautions for All MOS FET Relays* for precautions that apply to all MOS FET Relays.

G3VM-601G

MOS FET Relays SOP 4-pin, High-load-voltage Type

MOS FET Relays in SOP 4-pin packages for high load voltages

- Load voltage: 600 V

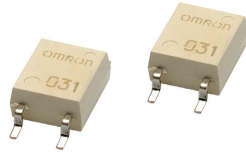

Note: The actual product is marked differently from the image shown here.

RoHS Compliant

Application Examples

- Semiconductor test equipment
- Test & Measurement equipment
- Communication equipment
- Various battery-driven devices
- Security equipment
- Industrial equipment
- Power circuit
- Amusement equipment

Package

(Unit : mm, Average)

SOP 4-pin

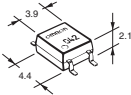

Note: The actual product is marked differently from the image shown here.

Model Number Legend

G3VM-□□□□
1 2 3 4

1. Load Voltage
60 : 600 V
2. Contact form
1 : 1a (SPST-NO)
3. Package
G : SOP 4-pin

4. Other informations

When specifications overlap, serial code is added in the recorded order.

Ordering Information

Package	Contact form	Terminals	Load voltage (peak value) *	Continuous load current (peak value) *	Stick packaging		Tape packaging	
					Model	Minimum package quantity	Model	Minimum package quantity
SOP4	1a (SPST-NO)	Surface-mounting Terminals	600 V	70 mA	G3VM-601G1	100 pcs.	G3VM-601G1(TR)	2,500 pcs.
				90 mA	G3VM-601G		G3VM-601G(TR)	

* The AC peak and DC value are given for the load voltage and continuous load current.

Note: To order tape packaging for Relays with surface-mounting terminals, add "(TR)" to the end of the model number.

Absolute Maximum Ratings (Ta = 25°C)

	Item	Symbol	G3VM-601G1	G3VM-601G	Unit	Measurement conditions
Input	LED forward current	IF	30	50	mA	
	Repetitive peak LED forward current	IFP		1	A	100 μs pulses, 100 pps
	LED forward current reduction rate	ΔI _F /°C	-0.3	-0.5	mA/°C	Ta ≥ 25°C
	LED reverse voltage	V _R		5	V	
	Connection temperature	T _J		125	°C	
Output	Load voltage (AC peak/DC)	V _{OFF}		600	V	
	Continuous load current (AC peak/DC)	I _O	70	90	mA	
	ON current reduction rate	ΔI _O /°C	-0.7	-0.9	mA/°C	Ta ≥ 25°C
	Pulse ON current	I _{OP}	210	270	mA	t=100 ms, Duty=1/10
	Connection temperature	T _J		125	°C	
	Dielectric strength between I/O *	V _i		1500	Vrms	AC for 1 min
	Ambient operating temperature	Ta		-40 to +85	°C	With no icing or condensation
	Ambient storage temperature	Tstg		-55 to +125	°C	
	Soldering temperature	-		260	°C	10 s

* The dielectric strength between the input and output was checked by applying voltage between all pins as a group on the LED side and all pins as a group on the light-receiving side.

■Electrical Characteristics (Ta = 25°C)

Item		Symbol	G3VM-601G1	G3VM-601G	Unit	Measurement conditions	
Input	LED forward voltage	V _F	Minimum	1.1	1.0	V I _F =10 mA	
			Typical	1.27	1.15		
			Maximum	1.4	1.3		
Reverse current	I _R	Maximum	10		μA	V _R =5 V	
Capacitance between terminals	C _T	Typical	30		pF	V=0, f=1 MHz	
Input	Trigger LED forward current	I _{FT}	Typical	–	0.4	mA	G3VM-601G1 : I _o =70 mA G3VM-601G : I _o =90 mA
			Maximum	0.2	1		
Input	Release LED forward current	I _{FC}	Minimum	–	0.1	mA	I _{OFF} =100 μA
			Typical	0.001	–		
Output	Maximum resistance with output ON	R _{ON}	Typical	35	45	Ω	G3VM-601G1 : I _F =0.5 mA, I _o =70 mA, t < 1 s G3VM-601G : I _F =2 mA, I _o =90 mA
			Maximum	60			
Output	Current leakage when the relay is open	I _{LEAK}	Typical	1	–	nA	V _{OFF} =600 V
			Maximum	1,000			
Output	Capacitance between terminals	C _{OFF}	Typical	75		pF	V=0, f=1 MHz
Output	Capacitance between I/O terminals	C _{I-O}	Typical	0.8		pF	f=1 MHz, V _S =0 V
Output	Insulation resistance between I/O terminals	R _{I-O}	Minimum	1000		MΩ	V _{I-O} =500 VDC, RoH±60%
			Typical	10 ⁸			
Output	Turn-ON time	t _{ON}	Typical	2		ms	G3VM-601G1 : I _F =0.5 mA, R _L =200 Ω, V _{DD} =10 V * G3VM-601G : I _F =2 mA, R _L =200 Ω, V _{DD} =10 V *
			Maximum	10	8		
Output	Turn-OFF time	t _{OFF}	Typical	1		ms	G3VM-601G1 : I _F =0.5 mA, R _L =200 Ω, V _{DD} =10 V * G3VM-601G : I _F =2 mA, R _L =200 Ω, V _{DD} =10 V *
			Maximum	5	3		

* Turn-ON and Turn-OFF Times

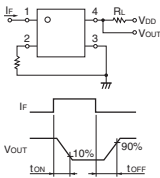

■Recommended Operating Conditions

For usage with high reliability, Recommended Operation Conditions is a measure that takes into account the derating of Absolute Maximum Ratings and Electrical Characteristics.

Each item on this list is an independent condition, so it is not simultaneously satisfy several conditions.

Item	Symbol		G3VM-601G1	G3VM-601G	Unit
Load voltage (AC peak/DC)	V _{DD}	Maximum	480		V
Operating LED forward current	I _F	Typical	0.5	2	mA
		Maximum	25		
Continuous load current (AC peak/DC)	I _o	Maximum	60	70	mA
Ambient operating temperature	T _a	Minimum	-20		
		Maximum	65		

■Spacing and Insulation

Item	Minimum	Unit
Creepage distances	4.0	mm
Clearance distances	4.0	
Internal isolation thickness	0.1	

Engineering Data

LED forward current vs. Ambient temperature

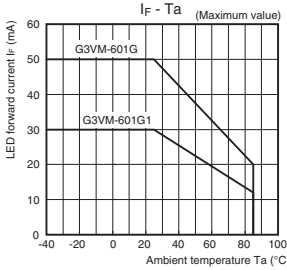

Continuous load current vs. Ambient temperature

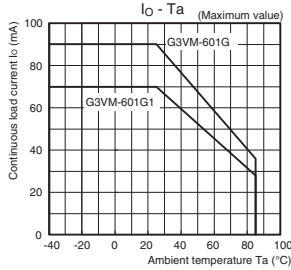

LED forward current vs. LED forward voltage

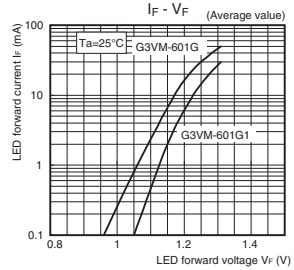

Continuous load current vs. On-state voltage

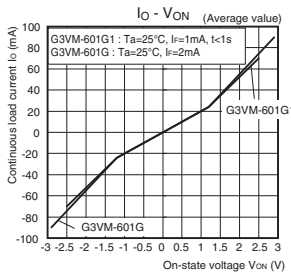

On-state resistance vs. Ambient temperature

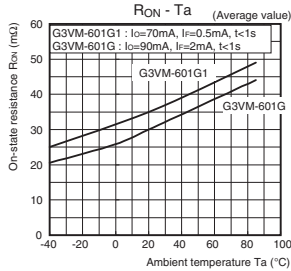

Trigger LED forward current vs. Ambient temperature

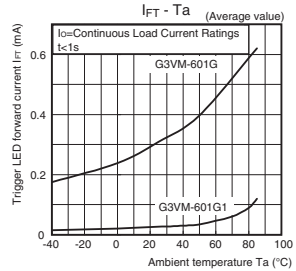

Turn ON, Turn OFF time vs. LED forward current

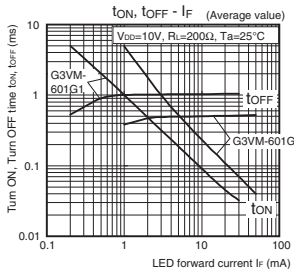

Turn ON, Turn OFF time vs. Ambient temperature

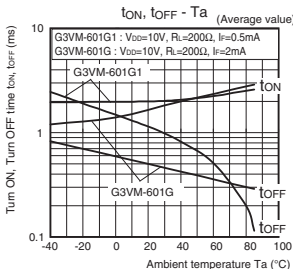

Current leakage vs. Ambient temperature

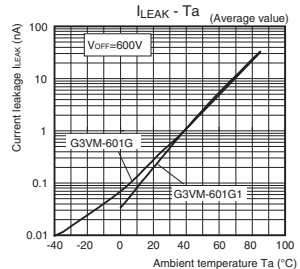

Current leakage vs. Load voltage G3VM-601G1

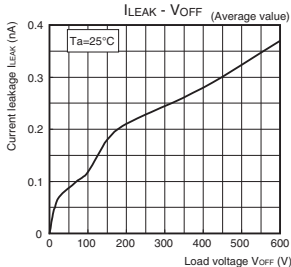

G3VM-601G

MOS FET Relays

Appearance / Terminal Arrangement / Internal Connections

● Appearance

SOP (Small Outline Package)

SOP 4-pin

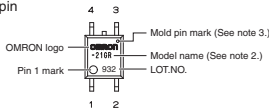
**Note 1.** The actual product is marked differently from the image shown here.**Note 2.** "G3VM" does not appear in the model number on the Relay.**Note 3.** The indentation in the corner diagonally opposite from the pin 1 mark is from a pin on the mold.

● Terminal Arrangement/Internal Connections (Top View)

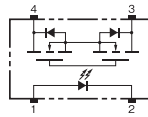

Dimensions (Unit: mm)



Surface-mounting Terminals

Weight: 0.1 g

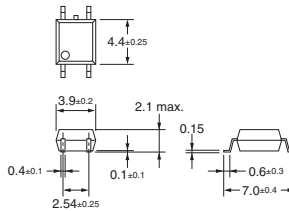

Actual Mounting Pad Dimensions

(Recommended Value, Top View)

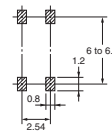
**Note:** The actual product is marked differently from the image shown here.

Approved Standards

UL recognized

Approved Standards	Contact form	File No.
UL (recognized)	1a (SPST-NO)	E80555

Safety Precautions

- Refer to the *Common Precautions for All MOS FET Relays* for precautions that apply to all MOS FET Relays.

G3VM-□C□/□F□/□CR/□FR

MOS FET Relays DIP 8-pin, Multi-contact-pair Type

MOS FET Relays in DIP 8-pin packages with multiple contact pairs for a wide range of circuits

- Contact form: 2a (DPST-NO), 2b (DPST-NC), 1a1b (SPST-NO/SPST-NC)
- Load voltage: 60 V, 350 V, or 400 V

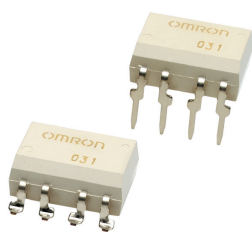

Note: The actual product is marked differently from the image shown here.

RoHS Compliant

Application Examples

- Communication equipment
- Test & Measurement equipment

Package (Unit: mm, Average)

DIP 8-pin

PCB Terminals

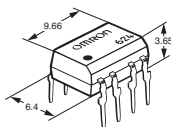

Surface-mounting Terminals

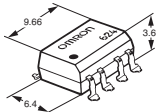

Note: The actual product is marked differently from the image shown here.

Model Number Legend

G3VM-□□□□□
1 2 3 4 5

1. Load Voltage

- 6 : 60 V
35 : 350 V
40 : 400 V

2. Contact form

- 2 : 2a (DPST-NO)
4 : 2b (DPST-NC)
5 : 1a1b

(SPST-NO/SPST-NC)

3. Package

- C : DIP 8-pin with PCB terminals
F : DIP 8-pin with surface-mounting terminals

4. Additional functions

- R: Low ON resistance

5. Other informations

When specifications overlap, serial code is added in the recorded order.

Ordering Information

Package	Contact form	Load voltage (peak value) *	Continuous load current (peak value) *	Stick packaging		Tape packaging	
				Model		Minimum package quantity	Minimum package quantity
				PCB Terminals	Surface-mounting Terminals		
DIP8	2a (DPST-NO)	60 V	500 mA	G3VM-62C1	G3VM-62F1	50 pcs.	G3VM-62F1(TR)
				G3VM-352C	G3VM-352F		G3VM-352F(TR)
	2b (DPST-NC)	350 V	150 mA	G3VM-354C	G3VM-354F		G3VM-354F(TR)
				1a1b (SPST-NO/SPST-NC)	120 mA		G3VM-355CR
	2a (DPST-NO)	400 V					G3VM-402C

* The AC peak and DC value are given for the load voltage and continuous load current.

Note: To order tape packaging for Relays with surface-mounting terminals, add "(TR)" to the end of the model number.

G3VM-□C□/□F□/□CR/□FR

MOS FET Relays

■Absolute Maximum Ratings (Ta = 25°C)

Item	Symbol	G3VM-62C1 G3VM-62F1	G3VM-352C G3VM-352F	G3VM-354C G3VM-354F	G3VM-355CR G3VM-355FR	G3VM-402C G3VM-402F	Unit	Measurement conditions	
Input	LED forward current	IF	50					mA	
	Repetitive peak LED forward current	IFP	1					A	100 μs pulses, 100 pps
	LED forward current reduction rate	ΔIF/°C	-0.5					mA/°C	Ta ≥ 25°C
	LED reverse voltage	VR	5					V	
	Connection temperature	TJ	125					°C	
Output	Load voltage (AC peak/DC)	VOFF	60	350		400		V	
	Continuous load current (AC peak/DC)	Io	500	120	150	120		mA	
	ON current reduction rate	ΔIo/°C	-5	-1.2	-1.5	-1.2		mA/°C	Ta ≥ 25°C
	Pulse ON current	Iop	1,500	360	450	360		mA	t=100 ms, Duty=1/10
	Connection temperature	TJ	125					°C	
	Dielectric strength between I/O *	Vi-o	2,500					Vrms	AC for 1 min
	Ambient operating temperature	Ta	-40 to +85					°C	With no icing or condensation
Ambient storage temperature	Tstg	-55 to +125					°C		
Soldering temperature	-	260					°C	10 s	

* The dielectric strength between the input and output was checked by applying voltage between all pins as a group on the LED side and all pins as a group on the light-receiving side.

G3VM-□C□/□F□/□CR/□FR

MOS FET Relays

■Electrical Characteristics (Ta = 25°C)

Item	Symbol		G3VM-62C1 G3VM-62F1	G3VM-352C G3VM-352F	G3VM-354C G3VM-354F	G3VM-355CR G3VM-355FR	G3VM-402C G3VM-402F	Unit	Measurement conditions
LED forward voltage	V _F	Minimum	1.0					V	I _F =10 mA
		Typical	1.15						
		Maximum	1.3						
		Reverse current	I _R	10					
Capacitance between terminals	C _T	Typical	30					pF	V=0, f=1 MHz
Trigger LED forward current	I _{FT} (I _{FC}) #2	Typical	1.6	1			mA	G3VM-62C1/62F1/352C/352F/402C/402F : I _o =Continuous load current ratings G3VM-354C/354F : I _o FF=10 μA G3VM-355CR/355FR : 1a : I _o =120 mA, 1b : I _o FF=10 μA	
		Maximum	3						
Release LED forward current	I _{FR} (I _{FT}) #2	Minimum	0.1					mA	G3VM-62C1/62F1/352C/352F/402C/402F : I _o FF=100 μA G3VM-354C/354F : I _o =150 mA G3VM-355CR/355FR : 1a : I _o FF=10 μA, 1b : I _o =120 mA
Maximum resistance with output ON	R _{ON}	Typical	1	35 (25)	15		18	Ω	G3VM-62C1/62F1/402C/402F/352C/352F : I _F =5 mA, I _o =Continuous load current ratings Values in parentheses are for t < 1 s. G3VM-354C/354F : I _o =150 mA G3VM-355CR/355FR : 1a : I _F =5 mA, I _o =120 mA, 1b : I _F =0 mA, I _o =120 mA
		Maximum	2	50 (35)	25		35		
Current leakage when the relay is open	I _{LEAK}	Maximum	1					μA	G3VM-354C/354F : V=0, f=1 MHz, I _F =5 mA G3VM-355CR/355FR : 1a : V=0, f=1 MHz, 1b : V=0, f=1 MHz, I _F =5 mA Others : V=0, f=1 MHz
Capacitance between terminals	C _{OFF}	Typical	130	30	85	65	40	pF	V=0, f=1 MHz
Capacitance between I/O terminals	C _{I-O}	Typical	0.8					pF	f=1 MHz, V _S =0 V
Insulation resistance between I/O terminals	R _{I-O}	Minimum	1000					MΩ	V _{I-O} =500 VDC, RoHS±60%
		Typical	10 ⁸						
Turn-ON time	t _{ON}	Typical	0.8	0.3	0.1	-		ms	I _F =5 mA, R _L =200 Ω, V _{OD} =20 V *1
		Maximum	2	1		1a : 1, 1b : 1	1		
Turn-OFF time	t _{OFF}	Typical	0.1	0.1	1	-		ms	I _F =5 mA, R _L =200 Ω, V _{OD} =20 V *1
		Maximum	0.5	1	3	1a : 1, 1b : 3	1		

*1. Turn-ON and Turn-OFF Times

*2. These values are for Relays with NC contacts

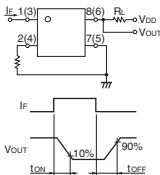

■Recommended Operating Conditions

For usage with high reliability, Recommended Operation Conditions is a measure that takes into account the derating of Absolute Maximum Ratings and Electrical Characteristics.

Each item on this list is an independent condition, so it is not simultaneously satisfy several conditions.

Item	Symbol		G3VM-62C1 G3VM-62F1	G3VM-352C G3VM-352F	G3VM-354C G3VM-354F	G3VM-355CR G3VM-355FR	G3VM-402C G3VM-402F	Unit
Load voltage (AC peak/DC)	V _{DD}	Maximum	48	280			320	V
		Minimum	5					
Operating LED forward current	I _F	Typical	7.5			-	7.5	mA
		Maximum	25					
		Continuous load current (AC peak/DC)	I _o	Maximum	500	100	150	
Ambient operating temperature	T _a	Minimum	-20					°C
		Maximum	65					

■Spacing and Insulation

Item	Minimum	Unit
Creepage distances	7.0	mm
Clearance distances	7.0	
Internal isolation thickness	0.4	

G3VM-□C□/□F□/□CR/□FR

MOS FET Relays

Engineering Data

LED forward current vs. Ambient temperature

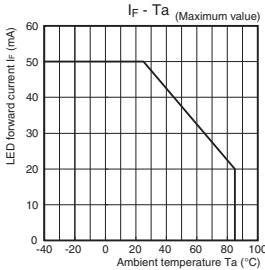

Continuous load current vs. Ambient temperature

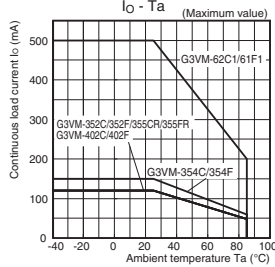

LED forward current vs. LED forward voltage

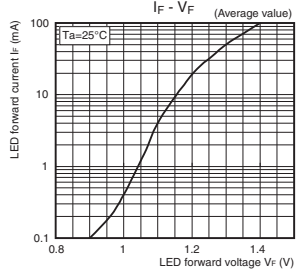

Continuous load current vs. On-state voltage

G3VM-62C1/62F1
G3VM-352C/352F/402C/402F
G3VM-355CR/355FR [SPST-NO Contacts]

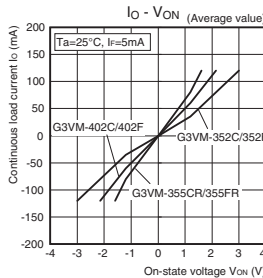
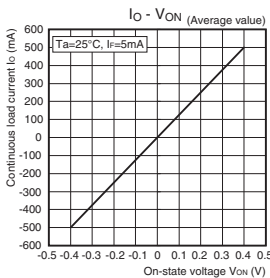

G3VM-354C/354F
G3VM-355CR/355FR [SPST-NC Contacts]

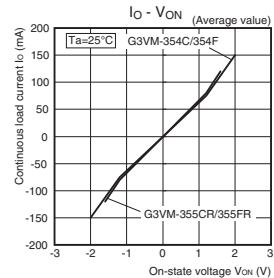

On-state resistance vs. Ambient temperature

G3VM-62C1/62F1
G3VM-352C/352F/402C/402F
G3VM-355CR/355FR [SPST-NO Contacts]

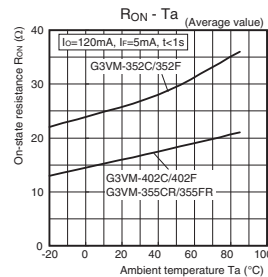
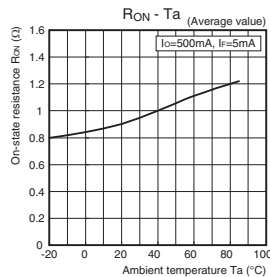

G3VM-354C/354F
G3VM-355CR/355FR [SPST-NC Contacts]

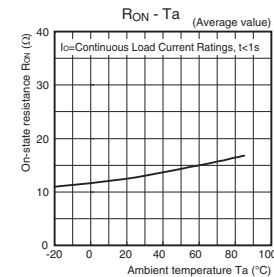

Trigger LED forward current vs. Ambient temperature

G3VM-62C1/62F1
G3VM-352C/352F/402C/402F
G3VM-355CR/355FR [SPST-NO Contacts]

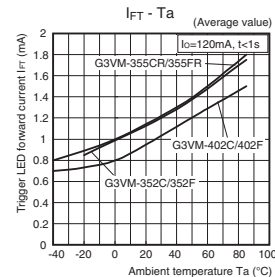
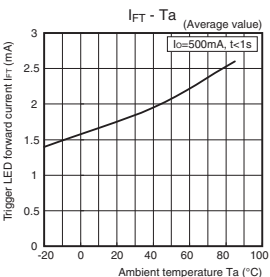

G3VM-354C/354F
G3VM-355CR/355FR [SPST-NC Contacts]

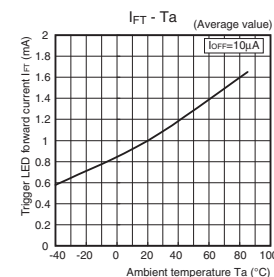

G3VM-□C□/□F□/□CR/□FR

MOS FET Relays

Engineering Data

● **Turn ON, Turn OFF time vs. LED forward current**
G3VM-62C1/62F1

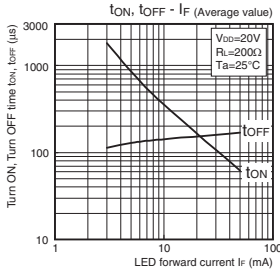

G3VM-352C/352F/402C/402F
G3VM-355CR/355FR [SPST-NO Contacts]

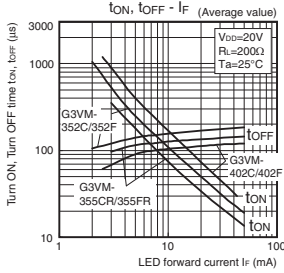

G3VM-354C/354F
G3VM-355CR/355FR [SPST-NC Contacts]

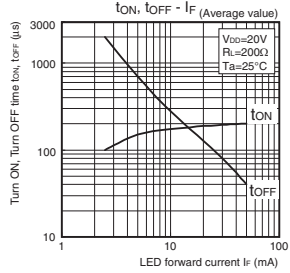

● **Turn ON, Turn OFF time vs. Ambient temperature**
G3VM-62C1/62F1

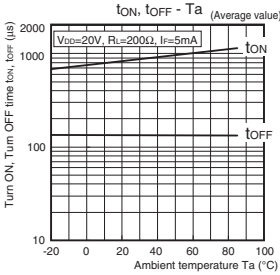

G3VM-352C/352F/402C/402F
G3VM-355CR/355FR [SPST-NO Contacts]

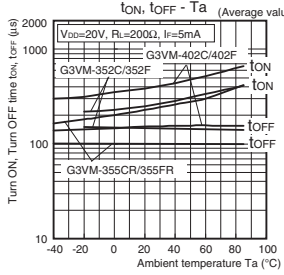

G3VM-354C/354F
G3VM-355CR/355FR [SPST-NC Contacts]

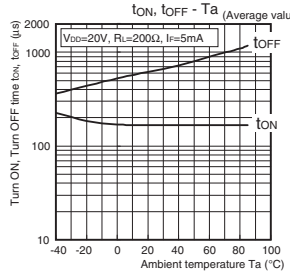

● **Current leakage vs. Ambient temperature**
G3VM-62C1/62F1/352C/352F/402C/402F
G3VM-355CR/355FR [SPST-NO Contacts]

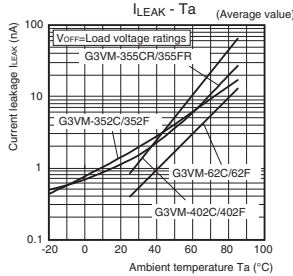

G3VM-354C/354F
G3VM-355CR/355FR [SPST-NC Contacts]

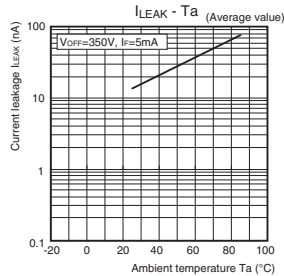

Introduction
 General-purpose
 High-voltage
 Multi-voltage
 High-current and Low-voltage
 Small and High-dielectric strength
 High-dielectric strength
 Current-limiting
 Low-voltage
 Small and High-voltage
 Certified Insulation
 DIP
 SOP
 SSOP
 USOP
 VSON
 S-VSON

G3VM-C□/□F□/□CR/□FR

G3VM-□□J□

MOS FET Relays SOP 8-pin, Multi-contact-pair Type

MOS FET Relays in SOP 8-pin packages with multiple contact pairs for a wide range of circuits

- Contact form: 2a (DPST-NO), 2b (DPST-NC), 1a1b (SPST-NO/SPST-NC)
- Load voltage: 60 V, 200 V, 350 V, or 400 V

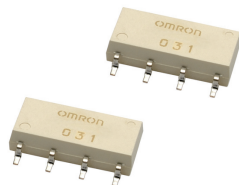

Note: The actual product is marked differently from the image shown here.

RoHS Compliant

Application Examples

- Semiconductor test equipment
- Security equipment
- Amusement equipment
- Test & Measurement equipment
- Industrial equipment
- Power circuit
- Communication equipment

Package (Unit : mm, Average)

SOP 8-pin

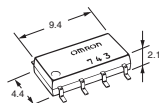

Note: The actual product is marked differently from the image shown here.

Model Number Legend

G3VM-□□□□□
1 2 3 4 5

- | | | |
|--------------------------------|--|-------------------|
| 1. Load Voltage | 2. Contact form | 3. Package |
| 6 : 60 V | 2 : 2a (DPST-NO) | J : SOP 8-pin |
| 20 : 20 V | 4 : 2b (DPST-NC) | |
| 35 : 350 V | 5 : 1a1b (SPST-NO/SPST-NC) | |
| 40 : 400 V | | |
| 4. Additional functions | 5. Other informations | |
| R: Low ON resistance | When specifications overlap, serial code is added in the recorded order. | |

Ordering Information

Package	Contact form	Terminals	Load voltage (peak value) *	Continuous load current (peak value) *	Stick packaging		Tape packaging	
					Model	Minimum package quantity	Model	Minimum package quantity
SOP8	2a (DPST-NO)	Surface-mounting Terminals	60 V	400 mA	G3VM-62J1	50 pcs.	G3VM-62J1(TR)	2,500 pcs.
			200 V	200 mA	G3VM-202J1		G3VM-202J1(TR)	
	350 V		120 mA	G3VM-355JR	G3VM-355JR(TR)			
			110 mA	G3VM-352J	G3VM-352J(TR)			
	400 V		120 mA	G3VM-354J	G3VM-354J(TR)			
				G3VM-402J	G3VM-402J(TR)			

* The AC peak and DC value are given for the load voltage and continuous load current.

Note: To order tape packaging for Relays with surface-mounting terminals, add "(TR)" to the end of the model number.

■ Absolute Maximum Ratings (Ta = 25°C)

Item		Symbol	G3VM-62J1	G3VM-202J1	G3VM-355JR	G3VM-352J	G3VM-354J	G3VM-402J	Unit	Measurement conditions	
Input	LED forward current	If	50							mA	
	LED forward current reduction rate	$\Delta I_f/\%C$	-0.5							mA/°C	Ta ≥ 25°C
	LED reverse voltage	V _R	5							V	
	Connection temperature	T _J	125							°C	
Output	Load voltage (AC peak/DC)	V _{OFF}	60	200	350		400			V	
	Continuous load current (AC peak/DC)	I _o	400	200	120	110	120			mA	
	ON current reduction rate	$\Delta I_o/\%C$	-4.0	-2.0	-1.2	-1.1	-1.2			mA/°C	Ta ≥ 25°C
	Pulse ON current	I _{op}	1,200	600	360	330	360			mA	t=100 ms, Duty=1/10
	Connection temperature	T _J	125							°C	
	Dielectric strength between I/O *	V _{I-O}	1500							V _{rms}	AC for 1 min
Ambient operating temperature	T _a	-40 to +85							°C	With no icing or condensation	
Ambient storage temperature	T _{stg}	-55 to +125							°C		
Soldering temperature	—	260							°C	10 s	

* The dielectric strength between the input and output was checked by applying voltage between all pins as a group on the LED side and all pins as a group on the light-receiving side.

Electrical Characteristics (Ta = 25°C)

Item	Symbol		G3VM-62J1	G3VM-202J1	G3VM-355JR	G3VM-352J	G3VM-354J	G3VM-402J	Unit	Measurement conditions
LED forward voltage	V _F	Minimum	1.0						V	I _F =10 mA
		Typical	1.15							
		Maximum	1.3							
Reverse current	I _R	Maximum	10						μA	V _R =5 V
Capacitance between terminals	C _T	Typical	30						pF	V=0, f=1 MHz
Trigger LED forward current	I _{FT} (I _{FC}) *2	Typical	1.6	1					mA	G3VM-62J1/202J1/352J/402J : I _O =Continuous load current ratings G3VM-355JR : 1a : I _O =120 mA, 1b : I _{OFF} =10 μA G3VM-354J : I _{OFF} =10 μA
		Maximum	3							
Release LED forward current	I _{FC} (I _{FT}) *2	Minimum	0.1						mA	G3VM-62J1/202J1/352J/402J : I _{OFF} =100 μA G3VM-355JR : 1a : I _{OFF} =10 μA, 1b : I _O =120 mA G3VM-354J : I _O =120 mA
Maximum resistance with output ON	R _{ON}	Typical	1	5	15	35 (25)	15	17	Ω	G3VM-62J1/202J1/352J/402J : I _F =5 mA, I _O =Continuous load current ratings G3VM-355JR : 1a : I _F =5 mA, I _O =120 mA, 1b : I _F =0, I _O =120 mA G3VM-352J : I _F =5 mA, I _O =110 mA, Values in parentheses are for t < 1 s. G3VM-354J : I _O =120 mA
		Maximum	2	8	25	50 (35)	25	35		
Current leakage when the relay is open	I _{LEAK}	Maximum	1						μA	G3VM-62J1/202J1/352J/402J : V _{OFF} =Load voltage ratings G3VM-355JR : 1a : V _{OFF} =350 V, I _F =5 mA G3VM-354J : V _{OFF} =350 V, I _F =5 mA
Capacitance between terminals	C _{OFF}	Typical	130	100	65	30	65	70	pF	G3VM-62J1/202J1/352J/402J : V=0, f=1 MHz G3VM-355JR : 1a : V=0, f=1 MHz, I _F =5 mA G3VM-354J : V=0, f=1 MHz, I _F =5 mA
Capacitance between I/O terminals	C _{I-O}	Typical	0.8						pF	f=1 MHz, V _S =0 V
Insulation resistance between I/O terminals	R _{I-O}	Minimum	1000						MΩ	V _{I-O} =500 VDC, RoHs60%
		Typical	10 ⁶							
Turn-ON time	t _{ON}	Typical	0.8	0.6	—	0.3	—	0.3	ms	I _F =0.5 mA, R _L =200 Ω, V _{DD} =20 V *1
		Maximum	2	1.5	1a : 1 1b : 1	—	1	—		
Turn-OFF time	t _{OFF}	Typical	0.1		—	0.1	—	0.1		
		Maximum	0.5	1	1a : 1 1b : 3	1	3	1		

*1. Turn-ON and Turn-OFF Times

*2. These values are for Relays with NC contacts

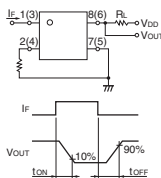

Recommended Operating Conditions

For usage with high reliability, Recommended Operation Conditions is a measure that takes into account the derating of Absolute Maximum Ratings and Electrical Characteristics.

Each item on this list is an independent condition, so it is not simultaneously satisfy several conditions.

Item	Symbol		G3VM-62J1	G3VM-202J1	G3VM-355JR	G3VM-352J	G3VM-354J	G3VM-402J	Unit
Load voltage (AC peak/DC)	V _{DD}	Maximum	48	200	280			320	V
Operating LED forward current	I _F	Minimum	5						mA
		Typical	7.5		—	10	—	7.5	
		Maximum	25						
Continuous load current (AC peak/DC)	I _O	Maximum	400	130	120	100	120		
Ambient operating temperature	T _a	Minimum	-20						°C
		Maximum	65						

■ Spacing and Insulation

Item	Minimum	Unit
Creepage distances	4.0	mm
Clearance distances	4.0	
Internal isolation thickness	0.1	

■ Engineering Data

● LED forward current vs. Ambient temperature

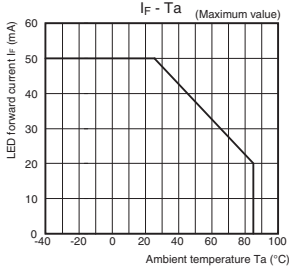

● Continuous load current vs. Ambient temperature

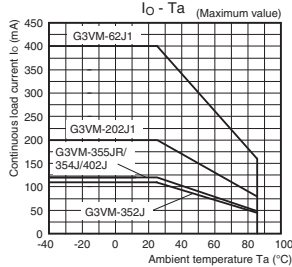

● LED forward current vs. LED forward voltage

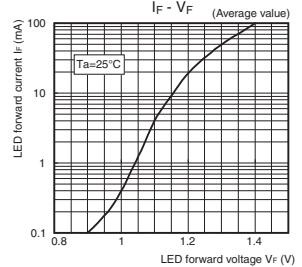

● Continuous load current vs. On-state voltage

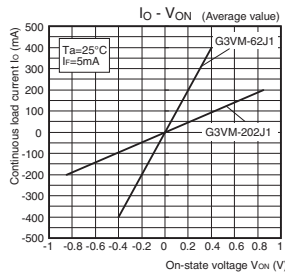

G3VM-355JR/352J/354J/402J

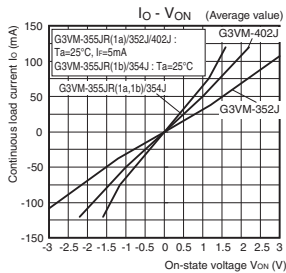

● On-state resistance vs. Ambient temperature

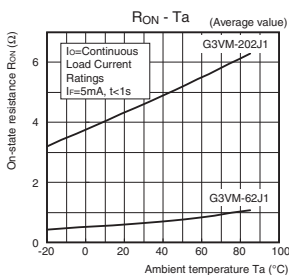

G3VM-355JR/352J/354J/402J

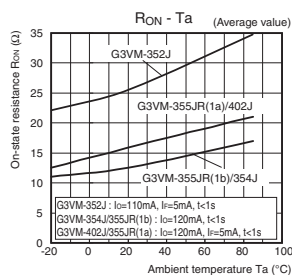

● Trigger LED forward current vs. Ambient temperature

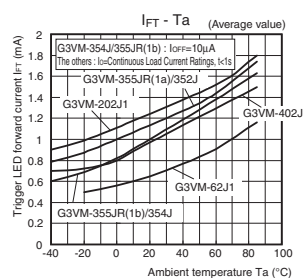

G3VM-□J□

MOS FET Relays

Engineering Data

● Turn ON, Turn OFF time vs. LED forward current
G3VM-62J1/202J1

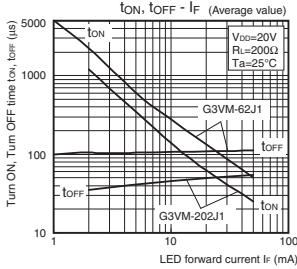

G3VM-355JR

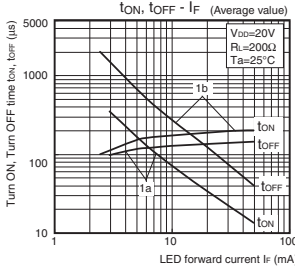

G3VM-352J/354J/402J

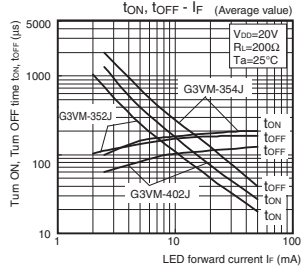

● Turn ON, Turn OFF time vs. Ambient temperature
G3VM-62J1/202J1

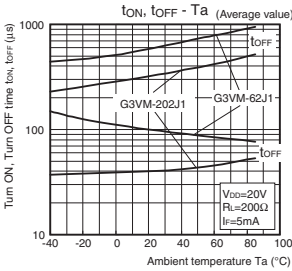

G3VM-355JR

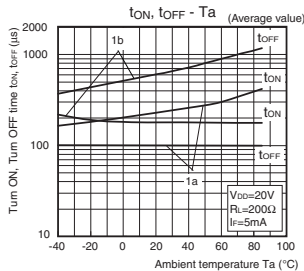

G3VM-352J/354J/402J

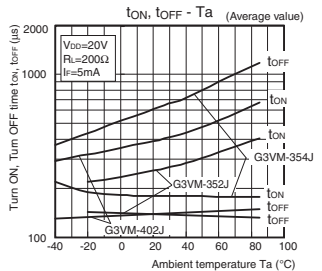

● Current leakage vs. Ambient temperature

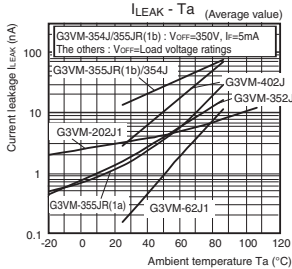

Introduction
General purpose
High-voltage
Multi-output
High-current and
Small and High-
Standard certification
DIP
SOP
SSOP
USOP
VSON
S-VSON
G3VM-□J□

G3VM-□J□

MOS FET Relays

■ Appearance / Terminal Arrangement / Internal Connections

● Appearance

SOP (Small Outline Package)

SOP 8-pin

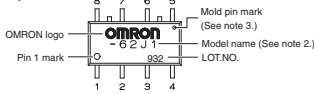

- Note:** 1. The actual product is marked differently from the image shown here.
Note: 2. "G3VM" does not appear in the model number on the Relay.
Note: 3. The indentation in the corner diagonally opposite from the pin 1 mark is from a pin on the mold.

● Terminal Arrangement/Internal Connections (Top View)

G3VM-62J1/202J1/352J/402J

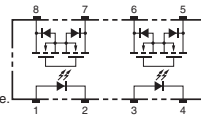

G3VM-355JR

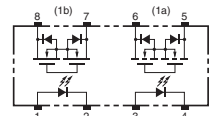

G3VM-354J

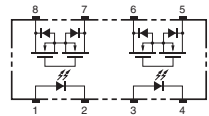

■ Dimensions (Unit: mm)

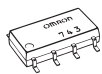

Surface-mounting Terminals

Weight: 0.2 g

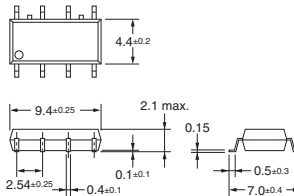

Actual Mounting Pad Dimensions

(Recommended Value, Top View)

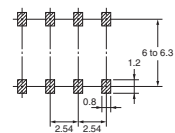

Note: The actual product is marked differently from the image shown here.

■ Approved Standards

UL recognized 

Model	Approved Standards	Contact form	File No.
G3VM-62J1	UL (recognized)	2a (DPST-NO)	E80555
G3VM-202J1		1a1b (SPST-NO/SPST-NC)	
G3VM-355JR			
G3VM-352J		2a (DPST-NO)	
G3VM-354J		2b (DPST-NC)	
G3VM-402J		2a (DPST-NO)	

Models Certified by BSI for EN/IEC Standards

Model	Approved Standards	Contact form	File No.
G3VM-402J	EN 60950/EN 60065 (BSI certified)	2a (DPST-NO)	8884 8885

■ Safety Precautions

- Refer to the *Common Precautions for All MOS FET Relays* for precautions that apply to all MOS FET Relays.

Introduction
General purpose
High-level voltage
Multi-contact pair
(2a, 2b, and 1a1b)
High-current and
Low-ON-resistance
Small and high-
frequency
High-dielectric
straight
Current-limiting
Low-output-capacitance
and low-ON-resistance
Small and High-
voltage
Certified Models with
Standards Certification
DIP
SOP
SSOP
USOP
VSON
MS-S

G3VM-□J□

G3VM-□AR/□DR

MOS FET Relays DIP 4-pin, High-current and Low-ON-resistance Type

MOS FET Relays in DIP 4-pin packages that achieve the low ON resistance and high switching capacity of a mechanical relay

- Load voltage: 20 V, 40 V, 60 V, or 100 V
- 20-V Relay: Continuous load current of 3 A max.
- 40-V Relay: Continuous load current of 2.5 A max.
- 60-V Relay: Continuous load current of 2 A max.
- 100-V Relay: Continuous load current of 1 A max.



Note: The actual product is marked differently from the image shown here.

RoHS Compliant

Application Examples

- Communication equipment
- Security equipment
- Power circuit
- Test & Measurement equipment
- Industrial equipment

Package (Unit : mm, Average)

DIP 4-pin
PCB Terminals

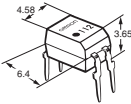

Surface-mounting Terminals

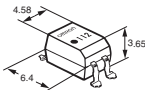

Note: The actual product is marked differently from the image shown here.

Model Number Legend

G3VM-□□□□□
1 2 3 4 5

- 1. Load Voltage**
2 : 20 V
4 : 40 V
6 : 60 V
10 : 100 V
- 2. Contact form**
1 : 1a (SPST-NO)
- 3. Package**
A : DIP 4-pin with PCB terminals
D : DIP 4-pin with surface-mounting terminals
- 4. Additional functions**
R: Low ON resistance
- 5. Other informations**
When specifications overlap, serial code is added in the recorded order.

Ordering Information

Package	Contact form	Load voltage (peak value) *	Continuous load current (peak value) *	Stick packaging		Tape packaging	
				Model		Minimum package quantity	Minimum package quantity
				PCB Terminals	Surface-mounting Terminals		
DIP4	1a (SPST-NO)	20 V	3 A	G3VM-21AR	G3VM-21DR	100 pcs.	G3VM-21DR(TR)
		40 V	2.5 A	G3VM-41AR	G3VM-41DR		G3VM-41DR(TR)
		60 V	2 A	G3VM-61AR	G3VM-61DR		G3VM-61DR(TR)
		100 V	1 A	G3VM-101AR	G3VM-101DR		G3VM-101DR(TR)

* The AC peak and DC value are given for the load voltage and continuous load current.

Note: To order tape packaging for Relays with surface-mounting terminals, add "(TR)" to the end of the model number.

G3VM-□AR/□DR

MOS FET Relays

■ Absolute Maximum Ratings (Ta = 25°C)

Item	Symbol	G3VM-21AR G3VM-21DR	G3VM-41AR G3VM-41DR	G3VM-61AR G3VM-61DR	G3VM-101AR G3VM-101DR	Unit	Measurement conditions		
Input	LED forward current	IF				30	mA		
	Repetitive peak LED forward current	IFP				1	A	100 μs pulses, 100 pps	
	LED forward current reduction rate	ΔIF/°C				-0.3	mA/°C	Ta ≥ 25°C	
	LED reverse voltage	VR				5	V		
	Connection temperature	TJ				125	°C		
Output	Load voltage (AC peak/DC)	VoFF		20	40	60	100	V	
	Continuous load current (AC peak/DC)	Io		3	2.5	2	1	A	
	ON current reduction rate	ΔIo/°C		-30	-25	-20	-10	mA/°C	Ta ≥ 25°C
	Pulse ON current	Iop		9	7.5	6	3	A	t=100 ms, Duty=1/10
	Connection temperature	TJ				125	°C		
	Dielectric strength between I/O *	Vi-o				2,500	Vrms	AC for 1 min	
	Ambient operating temperature	Ta				-40 to +85	°C	With no icing or condensation	
Ambient storage temperature	Tstg				-55 to +125	°C			
Soldering temperature	-				260	°C	10 s		

* The dielectric strength between the input and output was checked by applying voltage between all pins as a group on the LED side and all pins as a group on the light-receiving side.

G3VM-□AR/□DR

MOS FET Relays

■Electrical Characteristics (Ta = 25°C)

Item	Symbol		G3VM-21AR	G3VM-41AR	G3VM-61AR	G3VM-101AR	Unit	Measurement conditions	
			G3VM-21DR	G3VM-41DR	G3VM-61DR	G3VM-101DR			
Input	LED forward voltage	Minimum	1.18				V	If=10 mA	
		Typical	1.33						
		Maximum	1.48						
	Reverse current	Maximum	10				μA	Vr=5 V	
		Capacitance between terminals	Typical	70					pF
Trigger LED forward current	IF (IFC)	Typical	0.7	0.5			mA	Io=1 A	
		Maximum	3						
Release LED forward current	IFC (IFr)	Minimum	0.1				mA	IoFF=10 μA	
Output	Maximum resistance with output ON	Typical	40	50	80	250	mΩ	G3VM-21AR/21DR/41AR/41DR/61AR/61DR : If=5 mA, t < 1 s, Io=2 A G3VM-101AR/DR : If=5 mA, t < 1 s, Io=1 A	
		Maximum	80	150	200	700			
	Current leakage when the relay is open	ILEAK	Maximum	1				μA	Voff=Load voltage ratings
	Capacitance between terminals	COFF	Typical	300		250	200	pF	V=0, f=1 MHz
Capacitance between I/O terminals	CI-O	Typical	0.8				pF	f=1 MHz, Vs=0 V	
Insulation resistance between I/O terminals	RI-O	Minimum	1000				MΩ	Vi-o=500 VDC, RoH≤60%	
		Typical	10 ⁶						
Turn-ON time	tON	Typical	1		0.8		ms	If=5 mA, Rt=200 Ω, VDD=20 V *	
		Maximum	5						
Turn-OFF time	tOFF	Typical	0.3				ms	If=5 mA, Rt=200 Ω, VDD=20 V *	
		Maximum	1						

* Turn-ON and Turn-OFF Times

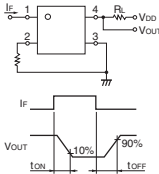

■Recommended Operating Conditions

For usage with high reliability, Recommended Operation Conditions is a measure that takes into account the derating of Absolute Maximum Ratings and Electrical Characteristics.

Each item on this list is an independent condition, so it is not simultaneously satisfy several conditions.

Item	Symbol		G3VM-21AR G3VM-21DR	G3VM-41AR G3VM-41DR	G3VM-61AR G3VM-61DR	G3VM-101AR G3VM-101DR	Unit
Load voltage (AC peak/DC)	VDD	Maximum	16	32	48	80	V
		Minimum	5				
Operating LED forward current	If	Typical	10				mA
		Maximum	25				
		Maximum	3	2.5	2	1	
Continuous load current (AC peak/DC)	Io	Maximum	3	2.5	2	1	A
		Ambient operating temperature	Ta	-20			
		Maximum	65				

■Spacing and Insulation

Item	Minimum	Unit
Creepage distances	7.0	mm
Clearance distances	7.0	
Internal isolation thickness	0.4	

G3VM-□AR/□DR

MOS FET Relays

Engineering Data

● LED forward current vs. Ambient temperature

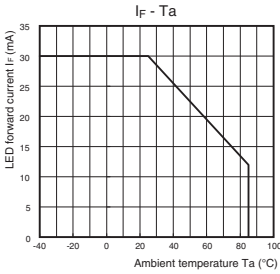

● Continuous load current vs. Ambient temperature

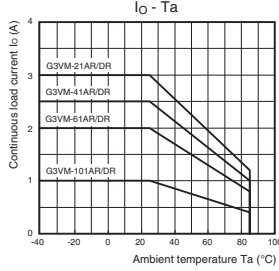

● LED forward current vs. LED forward voltage

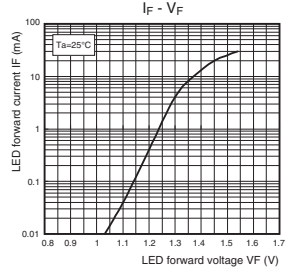

● Continuous load current vs. On-state voltage

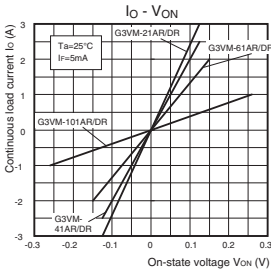

● On-state resistance vs. Ambient temperature

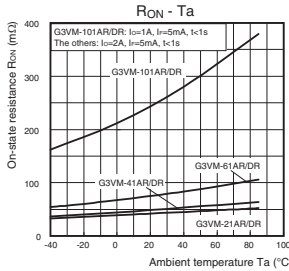

● Trigger LED forward current vs. Ambient temperature

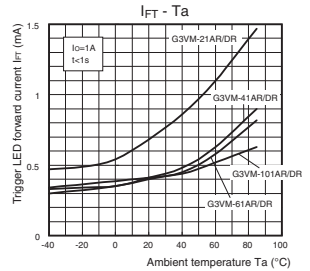

● Turn ON, Turn OFF time vs. LED forward current

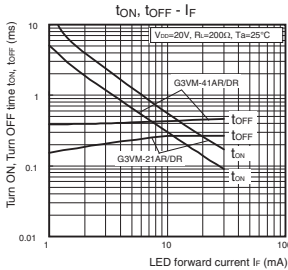

G3VM-61AR/61DR/101AR/101DR

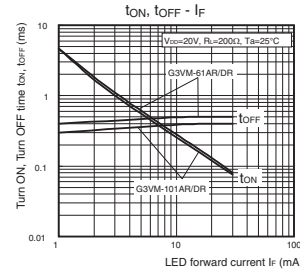

● Turn ON, Turn OFF time vs. Ambient temperature

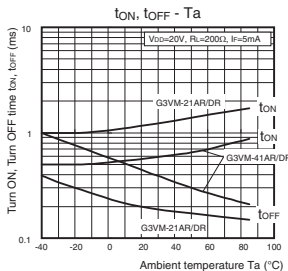

G3VM-61AR/61DR/101AR/101DR

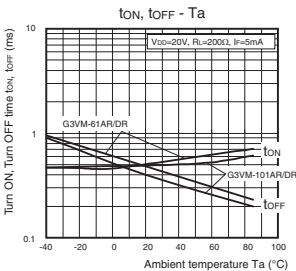

● Current leakage vs. Ambient temperature

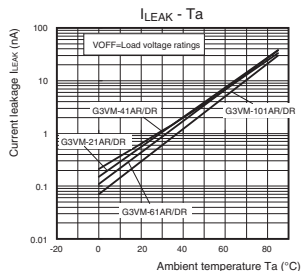

G3VM-□AR/□DR

MOS FET Relays

■ Appearance / Terminal Arrangement / Internal Connections

● Appearance

DIP (Dual Inline Package)

DIP 4-pin

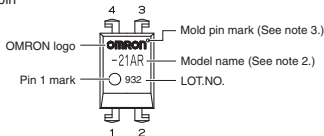
**Note:** 1. The actual product is marked differently from the image shown here.**Note:** 2. "G3VM" does not appear in the model number on the Relay.**Note:** 3. The indentation in the corner diagonally opposite from the pin 1 mark is from a pin on the mold.

● Terminal Arrangement/Internal Connections (Top View)

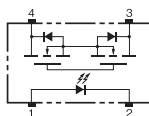

■ Dimensions (Unit: mm)



PCB Terminals

Weight: 0.25 g

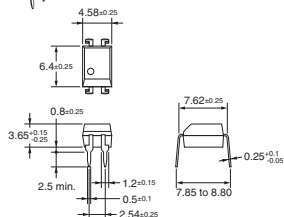

Surface-mounting Terminals

Weight: 0.25 g

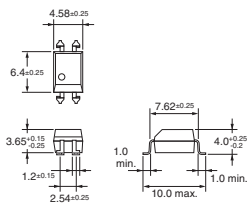

PCB Dimensions (BOTTOM VIEW)

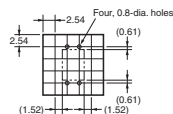

Actual Mounting Pad Dimensions

(Recommended Value, Top View)

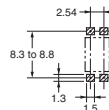
**Note:** The actual product is marked differently from the image shown here.

■ Approved Standards

UL recognized 

Approved Standards	Contact form	File No.
UL (recognized)	1a (SPST-NO)	E80555

■ Safety Precautions

- Refer to the *Common Precautions for All MOS FET Relays* for precautions that apply to all MOS FET Relays.

G3VM-□BR□/□ER□

MOS FET Relays DIP 6-pin, High-current and Low-ON-resistance Type

MOS FET Relays in DIP 6-pin packages that achieve the low ON resistance and high switching capacity of a mechanical relay

- Load voltage: 20 V, 40 V, 60 V, or 100 V
- 20-V Relay: Continuous load current of 4 A (8 A) max. *
- 40-V Relay: Continuous load current of 3.5 A (7 A) max. *
- 60-V G3VM-61BR/ER Relay: Continuous load current of 2.5 A max.
- 60-V G3VM-61BR1/ER1 Relay: Continuous load current of 3 A (6 A) max. *
- 100-V Relay: Continuous load current of 2 A (4 A) max. *

* Values in parentheses are for connection C.



Note: The actual product is marked differently from the image shown here.

RoHS Compliant

Application Examples

- Communication equipment
- Security equipment
- Power circuit
- Test & Measurement equipment
- Industrial equipment

Package (Unit : mm, Average)

DIP 6-pin
PCB Terminals

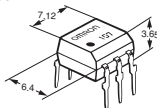

Surface-mounting Terminals

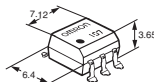

Note: The actual product is marked differently from the image shown here.

Model Number Legend

G3VM-□□□□□
1 2 3 4 5

- Load Voltage**
 - 20 V
 - 40 V
 - 60 V
 - 100 V
- Contact form**
 - 1a (SPST-NO)
- Package**
 - B : DIP 6-pin with PCB terminals
 - E : DIP 6-pin with surface-mounting terminals
- Additional functions**
 - R: Low ON resistance
- Other informations**
 - When specifications overlap, serial code is added in the recorded order.

Ordering Information

Package	Contact form	Load voltage (peak value) *	Continuous load current (peak value) *		Stick packaging			Tape packaging	
			Connection A, B	Connection C	PCB Terminals	Surface-mounting Terminals	Minimum package quantity	Model	Minimum package quantity
DIP6	1a (SPST-NO)	20 V	4 A	8 A	G3VM-21BR	G3VM-21ER	50 pcs.	G3VM-21ER(TR)	1,500 pcs.
		40 V	3.5 A	7 A	G3VM-41BR	G3VM-41ER		G3VM-41ER(TR)	
		60 V	2.5 A	—	G3VM-61BR	G3VM-61ER		G3VM-61ER(TR)	
			3 A	6 A	G3VM-61BR1	G3VM-61ER1		G3VM-61ER1(TR)	
		100 V	2 A	4 A	G3VM-101BR	G3VM-101ER		G3VM-101ER(TR)	

* The AC peak and DC value are given for the load voltage and continuous load current.

Note: To order tape packaging for Relays with surface-mounting terminals, add "(TR)" to the end of the model number.

G3VM-□BR□/□ER□

MOS FET Relays

■ Absolute Maximum Ratings (Ta = 25°C)

Item	Symbol	G3VM-21BR G3VM-21ER	G3VM-41BR G3VM-41ER	G3VM-61BR G3VM-61ER	G3VM-61BR1 G3VM-61ER1	G3VM-101BR G3VM-101ER	Unit	Measurement conditions		
Input	LED forward current	IF					30	mA		
	Repetitive peak LED forward current	IFP					1	A	100 μs pulses, 100 pps	
	LED forward current reduction rate	$\Delta I_F/\%C$					-0.3	mA/%C	Ta ≥ 25°C	
	LED reverse voltage	VR					5	V		
	Connection temperature	TJ					125	°C		
Load voltage (AC peak/DC)	V _{OFF}	20	40	60		100	V			
Output	Continuous load current	Connection A	I _o	4	3.5	2.5	3	2	A	Connection A: AC peak/DC Connection B and C: DC
		Connection B		8	7	—	6	4		
		Connection C		—	—	—	—	—		
	ON current reduction rate	Connection A	$\Delta I_o/\%C$	-40	-35	-22	-30	-20	mA/%C	Ta ≥ 25°C
		Connection B		-80	-70	—	-60	-40		
Connection C		—		—	—	—	—			
Pulse ON current	I _{op}	12	10.5	7.5	9	6	A	t _s =100 ms, Duty=1/10		
Connection temperature	T _J	125					°C			
Dielectric strength between I/O *	V _{i-o}	2,500					V _{rms}	AC for 1 min		
Ambient operating temperature	T _a	-40 to +85		-20 to +85		-40 to +85		°C	With no icing or condensation	
Ambient storage temperature	T _{stg}	-55 to +125		-40 to +125		-55 to +125		°C		
Soldering temperature	—	260					°C	10 s		

* The dielectric strength between the input and output was checked by applying voltage between all pins as a group on the LED side and all pins as a group on the light-receiving side.

Connection Diagram

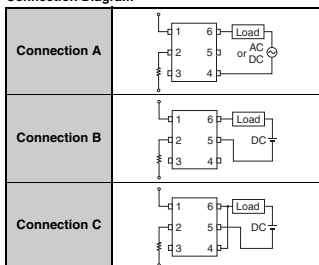

Note: Only connection A can be used for the G3VM-61BR/ER.

■Electrical Characteristics (Ta = 25°C)

Item		Symbol	G3VM-21BR G3VM-21ER	G3VM-41BR G3VM-41ER	G3VM-61BR G3VM-61ER	G3VM-61BR1 G3VM-61ER1	G3VM-101BR G3VM-101ER	Unit	Measurement conditions								
Input	LED forward voltage	V _F	Minimum				1.18		V	I _F =10 mA							
			Typical				1.33										
			Maximum				1.48										
	Reverse current	I _R	Maximum				10		μA	V _R =5 V							
Capacitance between terminals	C _T	Typical				70		pF	V=0, f=1 MHz								
Trigger LED forward current	I _{FT}	Typical	0.5		1		0.5		mA	I _O =1 A							
		Maximum	3														
Release LED forward current	I _{FC}	Minimum	0.1						mA	I _{OFF} =10 μA							
Output	Maximum resistance with output ON	R _{ON}	Connection A	Typical		20		30		65		40		100		mΩ	G3VM-21BR/21ER/41BR/41ER/ 61BR1/61ER1/101BR/101ER : I _F =5 mA, I _O =2 A (Connection A and B), I _O =4 A (Connection C), t<1 s G3VM-61BR/ER : I _F =10 mA, t=10 ms, I _O =2 A
				Maximum		50		60		100		70		200			
				Connection B	Typical		10		15				20		50		
	Connection C	Typical			5		8		-		10		25				
Current leakage when the relay is open		I _{LEAK}	Typical		-		0.001		-						μA	V _{OFF} =Load voltage ratings	
Capacitance between terminals	C _{OFF}	Typical		1000		400		1000						pF	V=0, f=1 MHz		
Capacitance between I/O terminals	C _{I-O}	Typical				0.8								pF	f=1 MHz, V _S =0 V		
Insulation resistance between I/O terminals	R _{I-O}	Minimum				1000								MΩ	V _{I-O} =500 VDC, R _{oH} ≤60%		
		Typical				10 ⁹											
Turn-ON time	t _{ON}	Typical		2.5		2		1		2				ms	G3VM-21BR/21ER/41BR/41ER/ 61BR1/61ER1/101BR/101ER : I _F =5 mA, R _L =200 Ω, V _{DD} =20 V * G3VM-61BR/ER : I _F =10 mA, R _L =200 Ω, V _{DD} =20 V *		
		Maximum		5		1.5		5									
Turn-OFF time	t _{OFF}	Typical		0.1		0.2		0.1									
		Maximum		1		0.4		1									

* Turn-ON and Turn-OFF Times

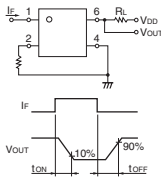

■Recommended Operating Conditions

For usage with high reliability, Recommended Operation Conditions is a measure that takes into account the derating of Absolute Maximum Ratings and Electrical Characteristics.

Each item on this list is an independent condition, so it is not simultaneously satisfy several conditions.

Item	Symbol	G3VM-21BR G3VM-21ER	G3VM-41BR G3VM-41ER	G3VM-61BR G3VM-61ER	G3VM-61BR1 G3VM-61ER1	G3VM-101BR G3VM-101ER	Unit							
Load voltage (AC peak/DC)	V _{DD}	Maximum		16		32		48		80		V		
Operating LED forward current	I _F	Minimum		5		10		5				mA		
		Typical		10		-		10						
		Maximum		25		20		25						
Continuous load current (AC peak/DC)	I _O	Maximum		4		3.5		2.5		3		2		A
		Minimum						-20						
Ambient operating temperature	T _a	Minimum				65		60		65		°C		
		Maximum												

■Spacing and Insulation

Item	Minimum	Unit
Creepage distances	7.0	mm
Clearance distances	7.0	
Internal isolation thickness	0.4	

Engineering Data

LED forward current vs. Ambient temperature

G3VM-21BR/21ER/41BR/41ER/
61BR1/61ER1/101BR/101ER

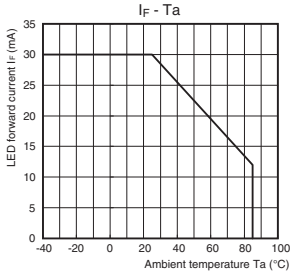

G3VM-61BR/61ER

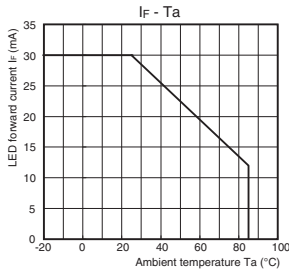

LED forward current vs. LED forward voltage

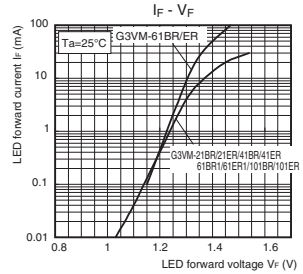

Continuous load current vs. Ambient temperature

G3VM-21BR/21ER/41BR/41ER

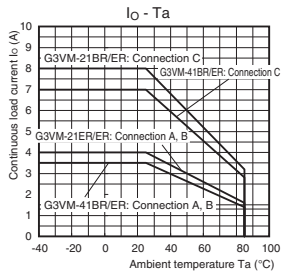

G3VM-61BR1/61ER1/101BR/101ER

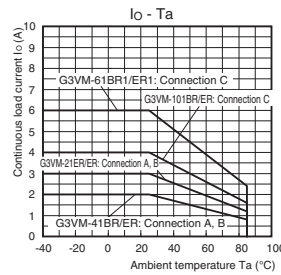

G3VM-61BR/61ER

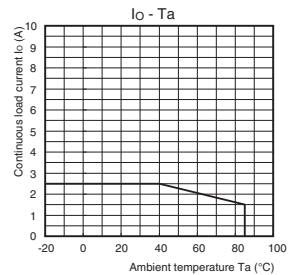

Continuous load current vs. On-state voltage

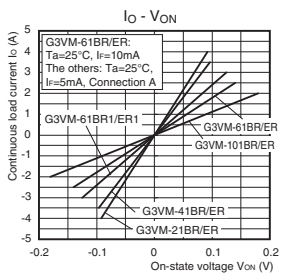

On-state resistance vs. Ambient temperature

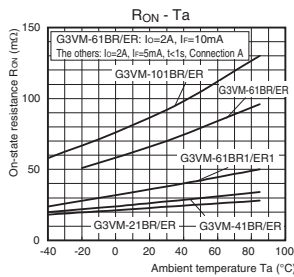

Trigger LED forward current vs. Ambient temperature

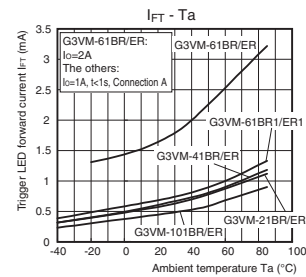

Engineering Data

● Turn ON, Turn OFF time vs.

LED forward current

G3VM-21BR/21ER/41BR/41ER

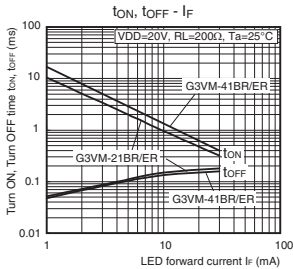

G3VM-61BR/61ER/61BR1/61ER1/101BR/101ER

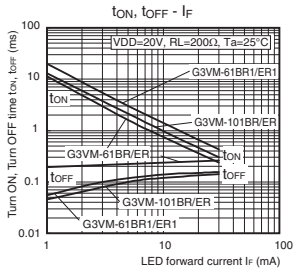

● Turn ON, Turn OFF time vs.

Ambient temperature

G3VM-21BR/21ER/41BR/41ER

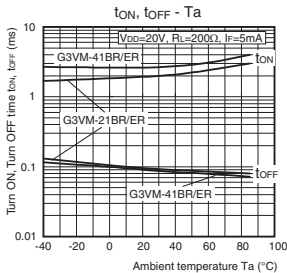

G3VM-61BR/61ER/61BR1/61ER1/101BR/101ER

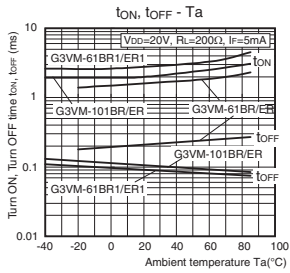

● Current leakage vs.

Ambient temperature

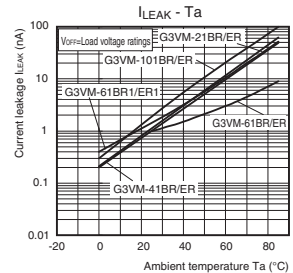

Appearance / Terminal Arrangement / Internal Connections

● Appearance

DIP (Dual In-line Package)

DIP 6-pin

G3VM-21BR/ER, -41BR/ER, -61BR1/ER1, -101BR/ER

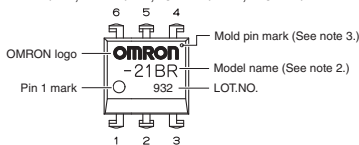

Special DIP 6-pin *

G3VM-61BR/ER

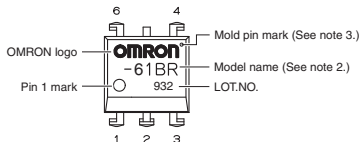

● Terminal Arrangement/Internal Connections (Top View)

G3VM-21BR/ER, -41BR/ER, -61BR1/ER1, -101BR/ER

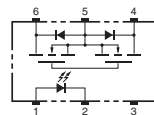

G3VM-61BR/ER

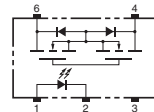

Note: 1. The actual product is marked differently from the image shown here.

Note: 2. "G3VM" does not appear in the model number on the Relay.

Note: 3. The indentation in the corner diagonally opposite from the pin 1 mark is from a pin on the mold.

* The external dimensions of the standard DIP 6-pin are the same, but the number of terminals is different.

G3VM-□BR□/□ER□

MOS FET Relays

■Dimensions (Unit: mm)

G3VM-21BR/41BR/61BR1/101BR

PCB Terminals

Weight: 0.4 g

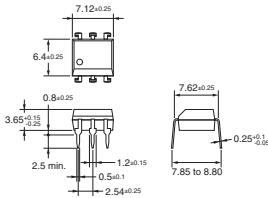

G3VM-21ER/41ER/61ER1/101ER

Surface-mounting Terminals

Weight: 0.4 g

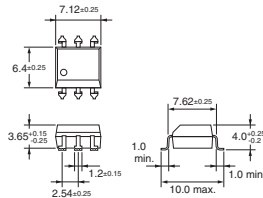

PCB Dimensions (BOTTOM VIEW)

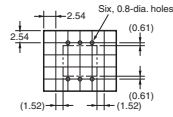

Actual Mounting Pad Dimensions

(Recommended Value, Top View)

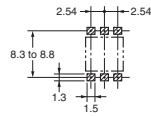

Note: The actual product is marked differently from the image shown here.

G3VM-61BR

PCB Terminals

Weight: 0.4 g

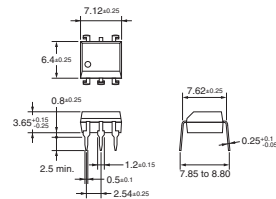

G3VM-61ER

Surface-mounting Terminals

Weight: 0.4 g

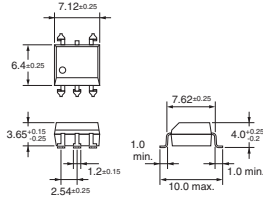

PCB Dimensions (BOTTOM VIEW)

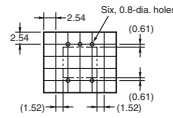

Actual Mounting Pad Dimensions

(Recommended Value, Top View)

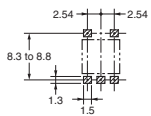

Note: The actual product is marked differently from the image shown here.

■Approved Standards

UL recognized 

Approved Standards	Contact form	File No.
UL (recognized)	1a (SPST-NO)	E80555

■Safety Precautions

- Refer to the *Common Precautions for All MOS FET Relays* for precautions that apply to all MOS FET Relays.

G3VM-□□CR□/□FR□

MOS FET Relays DIP 8-pin, High-Current and Low-ON-resistance Type

The highest class load current of MOS FET Relays realized with DIP8 package

- Contact form: 1a (SPST-NO)
- Load voltage: 60 V, 100 V, 200 V, 400 V, or 600 V
- 60-V Relay: Continuous load current of 5 A (10 A) max. *
- 100-V Relay: Continuous load current of 3 A (6 A) max. *
- 200-V Relay: Continuous load current of 1.5 A (3 A) max. *
- 400-V Relay: Continuous load current of 0.4 A (0.8 A) max. *
- 600-V Relay: Continuous load current of 0.6 A (1.2 A) max. *

* Values in parentheses are for connection C.

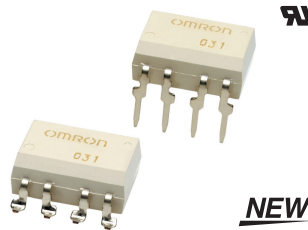

NEW

Note: The actual product is marked differently from the image shown here.

RoHS Compliant

Application Examples

- Communication equipment
- Test & Measurement equipment
- Security equipment
- Industrial equipment
- Power circuit

Package (Unit : mm, Average)

DIP 8-pin

PCB Terminals

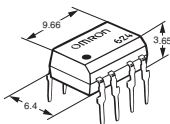

Surface-mounting Terminals

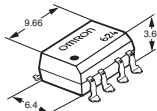

Note: The actual product is marked differently from the image shown here.

Model Number Legend

G3VM-□□□□□

1 2 3 4 5

1. Load Voltage

6 : 60 V
10 : 100 V
20 : 200 V
40 : 400 V
60 : 600 V

2. Contact form

1 : 1a (SPST-NO)

3. Package

C : DIP 8-pin with PCB terminals
F : DIP 8-pin with surface-mounting terminals

4. Additional functions

R : Low ON resistance

5. Other informations

When specifications overlap, serial code is added in the recorded order.

Ordering Information

Package	Contact form	Load voltage (peak value) *	Continuous load current (peak value) *	Stick packaging			Tape packaging	
				Model		Minimum package quantity	Model	Minimum package quantity
				PCB Terminals	Surface-mounting Terminals			
DIP8	1a (SPST-NO)	60 V	5 A	G3VM-61CR1	G3VM-61FR1	50 pcs.	G3VM-61FR1 (TR05)	500 pcs.
		100 V	3 A	G3VM-101CR	G3VM-101FR		G3VM-101FR (TR05)	
		200 V	1.5 A	G3VM-201CR	G3VM-201FR		G3VM-201FR (TR05)	
		400 V	0.4 A	G3VM-401CR	G3VM-401FR		G3VM-401FR (TR05)	
		600 V	0.6 A	G3VM-601CR	G3VM-601FR		G3VM-601FR (TR05)	

* The AC peak and DC value are given for the load voltage and continuous load current.

Note: To order tape packaging for Relays with surface-mounting terminals, add "(TR05)" to the end of the model number.

G3VM-□CR□/□FR□

MOS FET Relays

■ Absolute Maximum Ratings (Ta = 25°C)

Item		Symbol	G3VM-61CR1 G3VM-61FR1	G3VM-101CR G3VM-101FR	G3VM-201CR G3VM-201FR	G3VM-401CR G3VM-401FR	G3VM-601CR G3VM-601FR	Unit	Measurement conditions	
Input	LED forward current	IF	30						mA	
	Repetitive peak LED forward current	IFP	1						A	100 μs pulses, 100 pps
	LED forward current reduction rate	ΔIF/°C	-0.3						mA/°C	Ta ≥ 25°C
	LED reverse voltage	VR	5						V	
	Connection temperature	TJ	125						°C	
Load voltage (AC peak/DC)		V _{OFF}	60	100	200	400	600	V		
Output	Continuous load current	Connection A	5	3	1.5	0.4	0.6	A	Connection A: AC peak/DC Connection B and C: DC	
		Connection B	5	3	1.5	0.4	0.6			
		Connection C	10	6	3	0.8	1.2			
	ON current reduction rate	Connection A	ΔI _o /°C	-50	-30	-15	-4	-6	mA/°C	Ta ≥ 25°C
		Connection B	-50	-30	-15	-4	-6			
		Connection C	-100	-60	-30	-8	-12			
Pulse ON current		I _{op}	15	9	4.5	1.2	1.8	A	t=100 ms, Duty=1/10	
Connection temperature		TJ	125						°C	
Dielectric strength between I/O *		V _{i-o}	2,500						Vrms	AC for 1 min
Ambient operating temperature		Ta	-40 to +85	-40 to +110		-40 to +85		°C	With no icing or condensation	
Ambient storage temperature		Tstg	-55 to +125						°C	
Soldering temperature		-	260						°C	10 s

* The dielectric strength between the input and output was checked by applying voltage between all pins as a group on the LED side and all pins as a group on the light-receiving side.

Connection Diagram

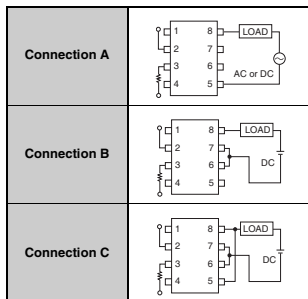

G3VM-□CR□/□FR□

MOS FET Relays

■Electrical Characteristics (Ta = 25°C)

Item		Symbol	G3VM-61CR1 G3VM-61FR1	G3VM-101CR G3VM-101FR	G3VM-201CR G3VM-201FR	G3VM-401CR G3VM-401FR	G3VM-601CR G3VM-601FR	Unit	Measurement conditions	
Input	LED forward voltage	V _F	Minimum	1.5				V	I _F =10 mA	
			Typical	1.64						
			Maximum	1.8						
	Reverse current	I _R	Maximum	10				μA	V _R =5 V	
	Capacitance between terminals	C _T	Typical	70				pF	V=0, f=1MHz	
Trigger LED forward current	I _{FT}	Typical	0.28	0.3	0.3	0.2	0.23	mA	G3VM-61CR1/FR1 : I _o =1 A G3VM-101CR/FR : I _o =1 A G3VM-201CR/FR : I _o =1 A G3VM-401CR/FR : I _o =0.4 A G3VM-601CR/FR : I _o =0.6 A	
		Maximum	5	5	5	1	5			
Release LED forward current	I _{FC}	Minimum	0.01				mA	G3VM-61CR1/FR1 : I _{off} =1 μA G3VM-101CR/FR : I _{off} =1 μA G3VM-201CR/FR : I _{off} =1 μA G3VM-401CR/FR : I _{off} =10 μA G3VM-601CR/FR : I _{off} =1 μA		
		Typical	0.19	-	0.19	0.17				
Maximum resistance with output ON	Connection A	R _{ON}	Typical	0.022	0.06	0.25	3	1.3	Ω	G3VM-61CR1/FR1 : I _o =1 A, I _F =5 mA, t < 1 s G3VM-101CR/FR : I _o =1 A, I _F =5 mA, t < 1 s G3VM-201CR/FR : I _o =1 A, I _F =5 mA, t < 1 s G3VM-401CR/FR : I _o =0.4 A, I _F =2 mA, t < 1 s G3VM-601CR/FR : I _o =0.6 A, I _F =5 mA, t < 1 s
			Maximum	0.05	0.15	0.5	5	2		
			Connection B	Maximum	0.025	0.075	0.25	2.5		1
Connection C	Maximum	0.013		0.075	0.25	1.3	0.5	G3VM-61CR1/FR1 : I _o =1 A, I _F =2 mA, t < 1 s G3VM-101CR/FR : I _o =1 A, I _F =5 mA, t < 1 s G3VM-201CR/FR : I _o =1 A, I _F =5 mA, t < 1 s G3VM-401CR/FR : I _o =0.8 A, I _F =2 mA, t < 1 s G3VM-601CR/FR : I _o =1.2 A, I _F =2 mA, t < 1 s		
	Current leakage when the relay is open	I _{LEAK}	Typical	0.01	0.02	0.1	0.001	0.05	μA	V _{off} =Load Voltage Ratings
Maximum			10	1	1	1	10			
Capacitance between terminals	C _{OFF}	Typical	850	720	400	410	4,300	pF	V=0, f=1 MHz	
Capacitance between I/O terminals	C _{I-O}	Typical	0.8				pF	f=1 MHz, V _s =0 V		
Insulation resistance between I/O terminals	R _{I-O}	Minimum	1,000				MΩ	V _{I-O} =500 VDC, R _{oH} =60%		
		Typical	10 ⁸							
Turn-ON time	t _{ON}	Typical	2.5	1.5	0.25	0.22	0.8	ms	I _F =5 mA, R _L =200 Ω, V _{DD} =20 V *	
Maximum	5				1	3				
Turn-OFF time	t _{OFF}	Typical	0.1		0.08	0.07	1			
		Maximum								

* Turn-ON and Turn-OFF Times

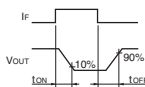
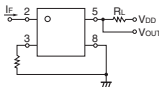

■Recommended Operating Conditions

For usage with high reliability, Recommended Operation Conditions is a measure that takes into account the derating of Absolute Maximum Ratings and Electrical Characteristics.

Each item on this list is an independent condition, so it is not simultaneously satisfy several conditions.

Item	Symbol		G3VM-61CR1 G3VM-61FR1	G3VM-101CR G3VM-101FR	G3VM-201CR G3VM-201FR	G3VM-401CR G3VM-401FR	G3VM-601CR G3VM-601FR	Unit
			Load voltage (AC peak/DC)	V _{DD}	Maximum	48	80	
Operating LED forward current	I _F	Typical	5	5	5	2	5	mA
		Maximum	25					
Continuous load current (AC peak/DC)	I _o	Maximum	5	3	1.5	0.4	0.6	A
Ambient operating temperature	T _a	Minimum	-40				85	°C
		Maximum						

■Spacing and Insulation

Item	Minimum	Unit
Creepage distances	7.0	mm
Clearance distances	7.0	
Internal isolation thickness	0.4	

Engineering Data

LED forward current vs. Ambient temperature

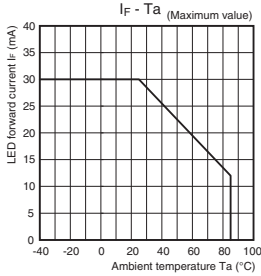

LED forward current vs. LED forward voltage

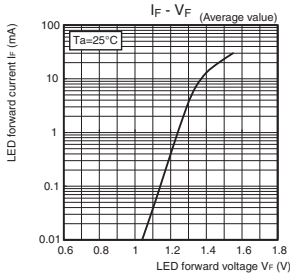

On-state resistance vs. Ambient temperature

G3VM-61CR1/61FR1
G3VM-101CR/101FR/201CR/201FR

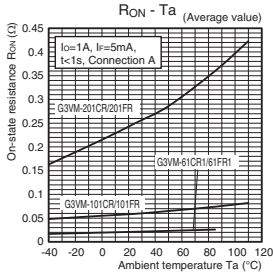

Continuous load current vs. Ambient temperature

G3VM-61CR1/61FR1
G3VM-101CR/101FR/201CR/201FR

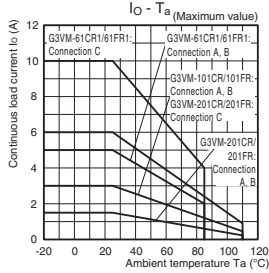

Continuous load current vs. On-state voltage

G3VM-61CR1/61FR1
G3VM-101CR/101FR/201CR/201FR

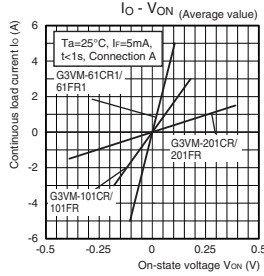

G3VM-401CR/401FR/601CR/601FR

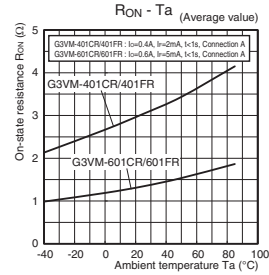

G3VM-401CR/401FR/601CR/601FR

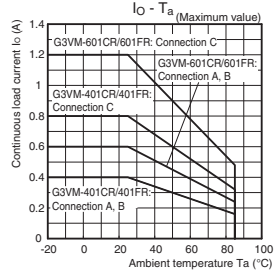

G3VM-401CR/401FR/601CR/601FR

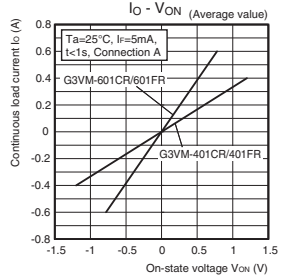

Trigger LED forward current vs. Ambient temperature

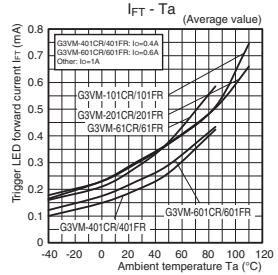

G3VM-□CR□/□FR□

MOS FET Relays

Engineering Data

Turn ON, Turn OFF time vs. LED forward current

G3VM-61CR1/61FR1 G3VM-401CR/401FR/601CR/601FR
 G3VM-101CR/101FR/201CR/201FR

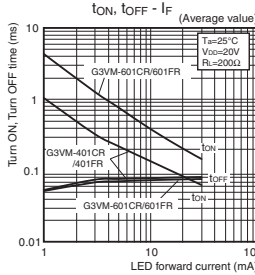
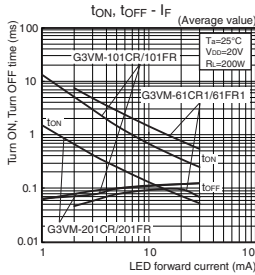

Turn ON, Turn OFF time vs. Ambient temperature

G3VM-61CR1/61FR1 G3VM-401CR/401FR/601CR/601FR
 G3VM-101CR/101FR/201CR/201FR

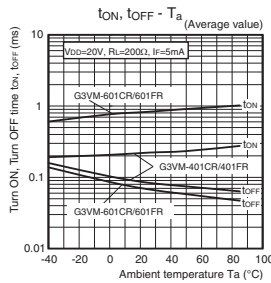
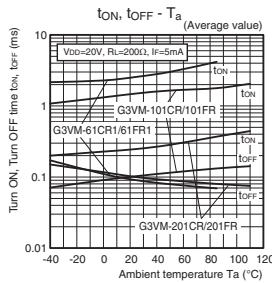

Current leakage vs. Ambient temperature

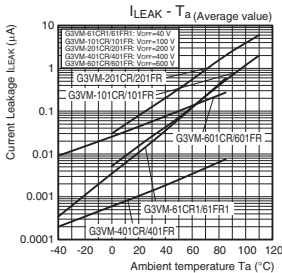

Appearance / Terminal Arrangement / Internal Connections

Appearance

DIP (Dual Inline Package)

DIP 8-pin

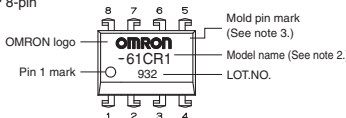

Terminal Arrangement/Internal Connections (Top View)

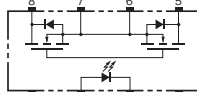

Note: 1. The actual product is marked differently from the image shown here.

Note: 2. "G3VM" does not appear in the model number on the Relay.

Note: 3. The indentation in the corner diagonally opposite from the pin 1 mark is from a pin on the mold.

G3VM-□CR□/□FR□**MOS FET Relays****■Dimensions** (Unit: mm)**DIP 8-pin****PCB Terminals**

Weight: 0.54 g

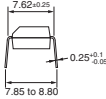
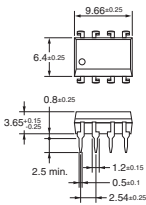
**Surface-mounting Terminals**

Weight: 0.54 g

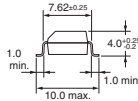
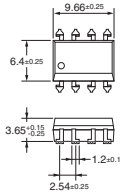
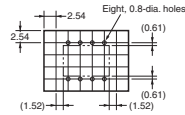
**PCB Dimensions (BOTTOM VIEW)****Actual Mounting Pad Dimensions**

(Recommended Value, Top View)

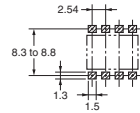
**Note:** The actual product is marked differently from the image shown here.**■Approved Standards**

UL recognized

Model	Approved Standards	Contact form	File No.
G3VM-61CR1 G3VM-61FR1	UL (recognized)	1a (SPST-NO)	E80555
G3VM-101CR G3VM-101FR			
G3VM-201CR G3VM-201FR			
G3VM-401CR G3VM-401FR			
G3VM-601CR G3VM-601FR			
G3VM-601FR			

■Safety Precautions

- Refer to the *Common Precautions for All MOS FET Relays* for precautions that apply to all MOS FET Relays.

G3VM-41GR8/61GR□/61VR

MOS FET Relays SOP 4-pin, High-current and Low-ON-resistance Type

MOS FET Relays in SOP4-pin that featuring the low ON resistance and high switching capacity as a mechanical relay.

- Load voltage: 40 V or 60 V
- 40-V Relay: Continuous load current of 1 A max.
- 60-V Relay: Continuous load current of 1.7 A max.

RoHS Compliant

Application Examples

- Semiconductor test equipment
- Test & Measurement equipment
- Communication equipment
- Security equipment
- Industrial equipment
- Power circuit
- Amusement equipment

Package

(Unit : mm, Average)

SOP 4-pin

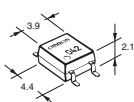

Special SOP 4-pin

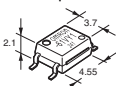

Note: The actual product is marked differently from the image shown here.

Model Number Legend

G3VM-□□□□□
1 2 3 4 5

- Load Voltage**
4 : 40 V
6 : 60 V
- Contact form**
1 : 1a (SPST-NO)
- Package**
G : SOP 4-pin
V : Special SOP 4-pin
- Additional function**
R : Low ON resistance
- Other informations**
When specifications overlap, serial code is added in the recorded order.

Ordering Information

Package	Contact form	Terminals	Load voltage (peak value) *	Continuous load current (peak value) *	Stick packaging		Tape packaging	
					Model	Minimum package quantity	Model	Minimum package quantity
SOP4	1a (SPST-NO)	Surface-mounting Terminals	40 V	1000 mA	G3VM-41GR8	100 pcs.	G3VM-41GR8(TR)	2,500 pcs.
				1400 mA	G3VM-61GR1		G3VM-61GR1(TR)	
			60 V	1700 mA	G3VM-61GR2	100 pcs.	G3VM-61VR	500 pcs.
							G3VM-61VR(TR)	3,000 pcs.
						G3VM-61GR2(TR05)	2,500 pcs.	

* The AC peak and DC value are given for the load voltage and continuous load current.

Note: To order tape packaging for Relays with surface-mounting terminals, add "(TR)" or "(TR05)" to the end of the model number.

Absolute Maximum Ratings (Ta = 25°C)

Item	Symbol	G3VM-41GR8	G3VM-61GR1	G3VM-61VR	G3VM-61GR2	Unit	Measurement conditions	
Input	LED forward current	If	30	50	30	mA	Ta ≥ 25°C	
	LED forward current reduction rate	ΔIf/°C	-0.3	-0.5	-0.3	mA/°C		
	LED reverse voltage	Vr	5		6	5		V
Connection temperature		Tj	125			°C		
Load voltage (AC peak/DC)		Voff	40		60	V		
Output	Continuous load current (AC peak/DC)	Io	1000		1400	1700	mA	
	ON current reduction rate	ΔIo/°C	-13.3		-14	-17	mA/°C	
	Pulse ON current	Iop	2	3	4.2	5	A	t=100 ms, Duty=1/10
	Connection temperature	Tj	125				°C	
Dielectric strength between I/O *		Vi-o	1500		3750	1500	Vrms	AC for 1 min
Ambient operating temperature		Ta	-40 to +85	-20 to +85	-40 to +110	-40 to +85	°C	With no icing or condensation
Ambient storage temperature		Tstg	-55 to +125		-40 to +125	-55 to +125	°C	
Soldering temperature		-	260				°C	10 s

* The dielectric strength between the input and output was checked by applying voltage between all pins as a group on the LED side and all pins as a group on the light-receiving side.



NEW

Note: The actual product is marked differently from the image shown here.

Introduction
General purpose
High-side voltage
Multi-contact pair (2a, 2b, and 1a1)
High current and Low ON-resistance
Small and high dielectric strength
High dielectric strength
Current limiting
Low ON-resistance and Low ON-resistance
Small and High-side voltage
Certified Models with Standards Certification

G3VM-41GR8/61GR1/61VR

G3VM-41GR8/61GR□/61VR

MOS FET Relays

Electrical Characteristics (Ta = 25°C)

Item	Symbol	G3VM-41GR8	G3VM-61GR1	G3VM-61VR	G3VM-61GR2	Unit	Measurement conditions	
LED forward voltage	V _F	Minimum	1.18	1.0	1.1	1.18	V I _F =10 mA	
		Typical	1.33	1.15	1.27	1.33		
		Maximum	1.48	1.3	1.4	1.48		
Reverse current	I _R	Maximum 10				μA	V _R =5 V	
Capacitance between terminals	C _T	Typical 70	15	70		pF	V=0, f=1 MHz	
Trigger LED forward current	I _{FT}	Typical	1		0.6	mA	G3VM-41GR8/61GR1/61GR2: I _o =100 mA G3VM-61VR: I _o =1400 mA	
		Maximum	3					
Release LED forward current	I _{FC}	Minimum	0.1			mA	I _{OFF} =100 μA	
Maximum resistance with output ON	R _{ON}	Typical	0.1	0.25	0.13	0.08	Ω	G3VM-61GR2/61VR : I _F =5mA, I _o = Continuous load current ratings, t<1s G3VM-41GR8/61GR1: I _F =5mA, I _o = Continuous load current ratings
		Maximum	0.13	0.7	0.25	0.13		
Current leakage when the relay is open	I _{LEAK}	Typical	-				nA	G3VM-41GR8: V _{OFF} =30 V G3VM-61GR1/61VR/61GR2: V _{OFF} =60 V
		Maximum	1	100	1000	10		
Capacitance between terminals	C _{OFF}	Typical	300	90	100	250	pF	V=0, f=1 MHz
Capacitance between I/O terminals	C _{I-O}	Typical	0.8				pF	f=1 MHz, V _S =0 V
Insulation resistance between I/O terminals	R _{I-O}	Minimum	1000				MΩ	V _{I-O} =500 VDC, RoH≤60%
		Typical	10 ⁸					
Turn-ON time	t _{ON}	Typical	1.2	1.4	2	0.7	ms	I _F =5 mA, R _L =200 Ω, V _{DD} =20 V *
		Maximum	3					
Turn-OFF time	t _{OFF}	Typical	0.2	0.6	0.1	0.1	ms	I _F =5 mA, R _L =200 Ω, V _{DD} =20 V *
		Maximum	0.5	1	0.5	0.5		

* Turn-ON and Turn-OFF Times

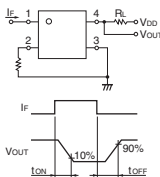

Recommended Operating Conditions

For usage with high reliability, Recommended Operation Conditions is a measure that takes into account the derating of Absolute Maximum Ratings and Electrical Characteristics.

Each item on this list is an independent condition, so it is not simultaneously satisfy several conditions.

Item	Symbol	G3VM-41GR8	G3VM-61GR1	G3VM-61VR	G3VM-61GR2	Unit	
Load voltage (AC peak/DC)	V _{DD}	Maximum 32	48			V	
Operating LED forward current	I _F	Maximum	5				mA
		Typical	10	7.5	10		
		Maximum	20	25			
Continuous load current (AC peak/DC)	I _o	Maximum 1000	1400		1300	°C	
Ambient operating temperature	T _a	Minimum	-20				
		Maximum	60	100	65		

Spacing and Insulation

Item	G3VM-□GR□	G3VM-61VR	Unit
	Minimum		
Creepage distances	4.0	5.0	mm
Clearance distances	4.0	5.0	
Internal isolation thickness	0.1	0.2	

G3VM-41GR8/61GR□/61VR

MOS FET Relays

Engineering Data

LED forward current vs. Ambient temperature

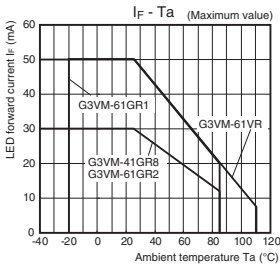

Continuous load current vs. Ambient temperature

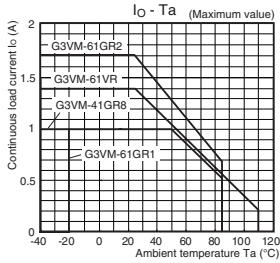

LED forward current vs. LED forward voltage

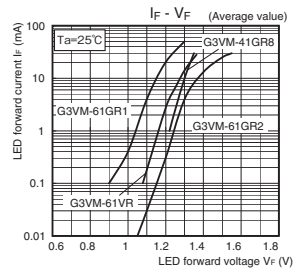

Continuous load current vs. On-state voltage

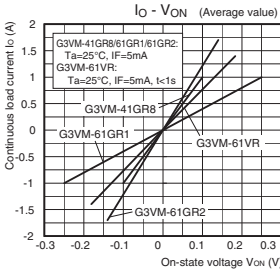

On-state resistance vs. Ambient temperature

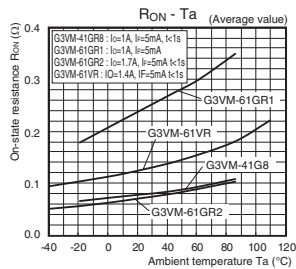

Trigger LED forward current vs. Ambient temperature

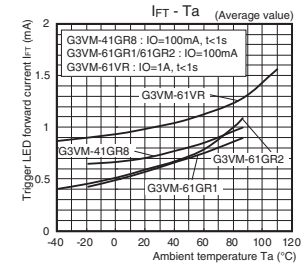

Turn ON, Turn OFF time vs. LED forward current

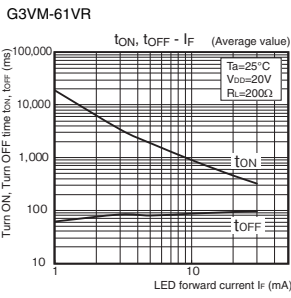
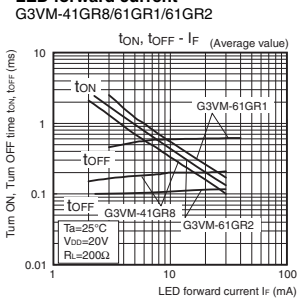

Turn ON, Turn OFF time vs. Ambient temperature

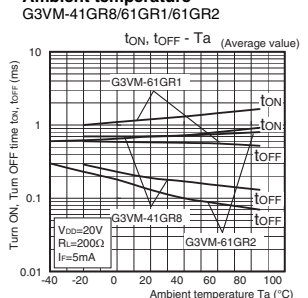

G3VM-61VR

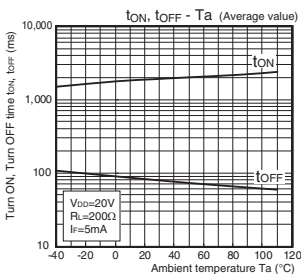

Current leakage vs. Ambient temperature

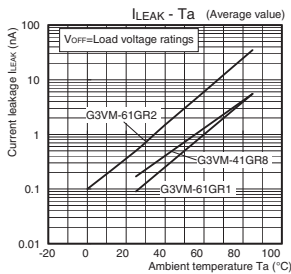

G3VM-61VR

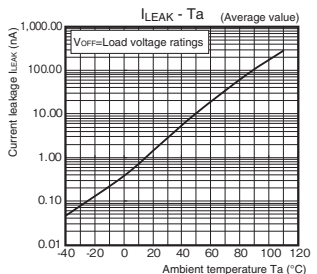

G3VM-41GR8/61GR□/61VR

MOS FET Relays

■Appearance / Terminal Arrangement / Internal Connections

●Appearance

SOP (Small Outline Package)

SOP 4-pin

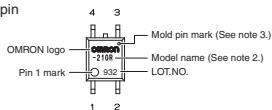
**Note: 1.** The actual product is marked differently from the image shown here.**Note: 2.** "G3VM" does not appear in the model number on the Relay.**Note: 3.** The indentation in the corner diagonally opposite from the pin 1 mark is from a pin on the mold.

●Terminal Arrangement/Internal Connections (Top View)

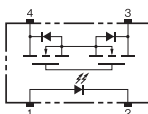

■Dimensions (Unit: mm)

SOP (Small Outline Package)

SOP 4-pin



Surface-mounting Terminals

Weight: 0.1 g

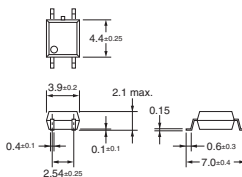

Actual Mounting Pad Dimensions

(Recommended Value, Top View)

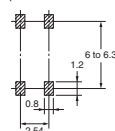
**Note:** The actual product is marked differently from the image shown here.

Special SOP 4-pin * (G3VM-61VR)



Surface-mounting Terminals

Weight: 0.1 g

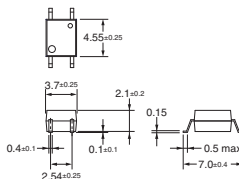

Actual Mounting Pad Dimensions

(Recommended Value, Top View)

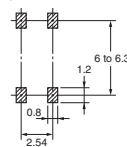

* The external dimensions are different from those of the standard SOP 4-pin, but the mounting pad dimensions are the same.

Note: The actual product is marked differently from the image shown here.

■Approved Standards

UL recognized

Model	Approved Standards	Contact form	File No.
G3VM-41GR8 G3VM-61GR1 G3VM-61GR2 G3VM-61VR	UL (recognized)	1a (SPST-NO)	E80555

■Safety Precautions

- Refer to the *Common Precautions for All MOS FET Relays* for precautions that apply to all MOS FET Relays.

G3VM-21HR/31HR/41HR/61HR/61HR1

MOS FET Relays SOP 6-pin, High-current and Low-ON-resistance Type

MOS FET Relays in SOP 6-pin packages that achieve the low ON resistance and high switching capacitance of a mechanical relay

- Load voltage: 20 V, 30 V, 40 V, or 60 V
- 20-V Relay: Continuous load current of 2.5 A (5 A) max. *
- 30-V Relay: Continuous load current of 4 A (8 A) max. *
- 40-V Relay: Continuous load current of 2.5 A (5 A) max. *
- 60-V Relay: Continuous load current of 3.3 A (6.6 A) max. *

* Values in parentheses are for connection C.

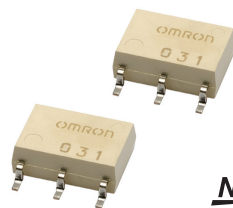

NEW

Note: The actual product is marked differently from the image shown here.

RoHS Compliant

Application Examples

- Semiconductor test equipment
- Security equipment
- Amusement equipment
- Communication equipment
- Industrial equipment
- Test & Measurement equipment
- Power circuit

Package (Unit : mm, Average)

SOP 6-pin

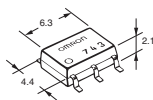

Note: The actual product is marked differently from the image shown here.

Model Number Legend

G3VM-□□□□□
1 2 3 4 5

- 1. Load Voltage**
2 : 20 V
3 : 30 V
4 : 40 V
6 : 60 V
- 2. Contact form**
1 : 1a (SPST-NO)
H : SOP 6-pin
- 3. Package**
H : SOP 6-pin
- 4. Additional functions**
R : Low ON resistance
- 5. Other informations**
When specifications overlap, serial code is added in the recorded order.

Ordering Information

Package	Contact form	Terminals	Load voltage (peak value) *	Continuous load current (peak value) *		Stick packaging		Tape packaging	
				Connection A, B	Connection C	Model	Minimum package quantity	Model	Minimum package quantity
SOP6	1a (SPST-NO)	Surface-mounting Terminals	20 V	2.5 A	5 A	G3VM-21HR	75	G3VM-21HR(TR)	2,500
			30 V	4 A	8 A	G3VM-31HR		G3VM-31HR(TR05)	500
			40 V	2.5 A	5 A	G3VM-41HR		G3VM-41HR(TR)	2,500
			60 V	2.3 A	4.6 A	G3VM-61HR		G3VM-61HR(TR)	2,500
				3.3 A	6.6 A	G3VM-61HR1		G3VM-61HR1(TR05)	500

* The AC peak and DC value are given for the load voltage and continuous load current.

Note: To order tape packaging for Relays with surface-mounting terminals, add "(TR)" to the end of the model number.

G3VM-21HR/31HR/41HR/61HR/61HR1 MOS FET Relays

■ Absolute Maximum Ratings (Ta = 25°C)

Item		Symbol	G3VM-21HR	G3VM-31HR	G3VM-41HR	G3VM-61HR	G3VM-61HR1	Unit	Measurement conditions	
Input	LED forward current	IF	30						mA	
	LED forward current reduction rate	$\Delta I_f/\%C$	-0.3						mA/°C	Ta ≥ 25°C
	LED reverse voltage	VR	5						V	
	Connection temperature	TJ	125						°C	
Load voltage (AC peak/DC)		V _{OFF}	20	30	40	60		V		
Output	Continuous load current	Connection A	Io	2500	4000	2500	2300	3300	mA	Connection A: AC peak/DC Connection B and C: DC
		Connection B		5000	8000	5000	4600	6600		
		Connection C								
	ON current reduction rate	Connection A	$\Delta I_o/\%C$	-33.3	-40	-33.3	-30.7	-33	mA/°C	G3VM-31HR/61HR1: Ta ≥ 25°C Others: Ta ≥ 50°C
		Connection B		-66.7	-80	-66.7	-61.3	-66		
	Connection C									
Pulse ON current		I _{op}	7.5	12	7.5	7	10	A	t=100 ms, Duty=1/10	
Connection temperature		TJ	125						°C	
Dielectric strength between I/O *		V _{i-o}	1500						V _{rms}	AC for 1 min
Ambient operating temperature		Ta	-40 to +85						°C	With no icing or condensation
Ambient storage temperature		Tstg	-55 to +125						°C	
Soldering temperature		-	260						°C	10 s

* The dielectric strength between the input and output was checked by applying voltage between all pins as a group on the LED side and all pins as a group on the light-receiving side.

Connection Diagram

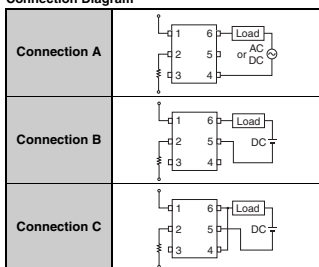

G3VM-21HR/31HR/41HR/61HR/61HR1 MOS FET Relays

■Electrical Characteristics (Ta = 25°C)

Item		Symbol	G3VM-21HR	G3VM-31HR	G3VM-41HR	G3VM-61HR	G3VM-61HR1	Unit	Measurement conditions	
Input	LED forward voltage	V _F	Minimum	1.18				V	I _F =10 mA	
			Typical	1.33						
			Maximum	1.48						
	Reverse current	I _R	Maximum	10				μA	V _R =5 V	
	Capacitance between terminals	C _T	Typical	70				pF	V=0, f=1 MHz	
Trigger LED forward current	I _{FT}	Typical	–	0.3	0.4		0.2	mA	G3VM-61HR1 : I _o =2000 mA Others : I _o =100 mA	
		Maximum	3							
		Release LED forward current	I _{FC}	Minimum	0.1					mA
Output	Maximum resistance with output ON	R _{ON}	Typical	0.02	0.02	0.03	0.04	0.03	Ω	G3VM-31HR: I _F =5 mA I _o =4 A (Connection A, B) I _o =8 A (C connections), t<1s Others: I _F =5 mA I _o =2 A (Connection A, B) I _o =4 A (C connections), t<1s
				0.01	0.008	0.015	0.02	0.015		
				0.005	0.004	0.008	0.01	0.008		
				0.05	0.04	0.06	0.07	0.06		
				0.025	0.02	0.03	0.04	–		
				–	0.01	–		–		
Current leakage when the relay is open	I _{LEAK}	Typical	–				nA	V _{OFF} = Load voltage ratings		
Maximum	10	1000	10	20						
Capacitance between terminals	C _{OFF}	Typical	1000	1100	1000	700	pF	V=0, f=1 MHz		
		Maximum	–						1500	
		Capacitance between I/O terminals	C _{I-O}	Typical	0.8				pF	f=1 MHz, V _s =0 V
Insulation resistance between I/O terminals	R _{I-O}	Minimum	1000				MΩ	V _{I-O} =500 VDC, RoHs:60%		
		Typical	10 ⁸							
Turn-ON time	t _{ON}	Typical	1.5	1.1	1.0	0.6	ms	G3VM-21HR : I _F =5 mA, R _L =200 Ω, V _{DD} =10 V * Others : I _F =5 mA, R _L =200 Ω, V _{DD} =20 V *		
Maximum	5									
Turn-OFF time	t _{OFF}	Typical	0.1	0.1	0.15	0.2	ms			
		Maximum	1							

* Turn-ON and Turn-OFF Times

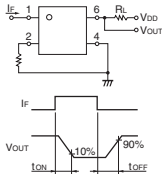

■Recommended Operating Conditions

For usage with high reliability, Recommended Operation Conditions is a measure that takes into account the derating of Absolute Maximum Ratings and Electrical Characteristics.

Each item on this list is an independent condition, so it is not simultaneously satisfy several conditions.

Item	Symbol	G3VM-21HR	G3VM-31HR	G3VM-41HR	G3VM-61HR	G3VM-61HR1	Unit	
Load voltage (AC peak/DC)	V _{DD}	Maximum	20	24	40	60	48	V
		Minimum	5					
Operating LED forward current	I _F	Typical	10		7.5		10	mA
		Maximum	20	25	20		25	
Continuous load current (AC peak/DC)	I _o	Maximum	2000	4000	2000	1800	3300	
Ambient operating temperature	T _a	Minimum	-20				°C	
		Maximum	65					

■Spacing and Insulation

Item	Minimum	Unit
Creepage distances	4.0	mm
Clearance distances	4.0	
Internal isolation thickness	0.1	

G3VM-21HR/31HR/41HR/61HR/61HR1 MOS FET Relays

Engineering Data

LED forward current vs. Ambient temperature

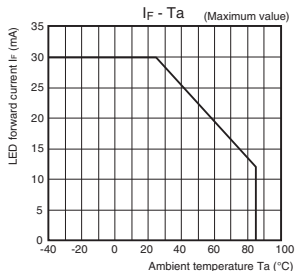

LED forward current vs. LED forward voltage

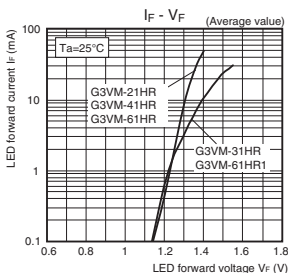

On-state resistance vs. Ambient temperature

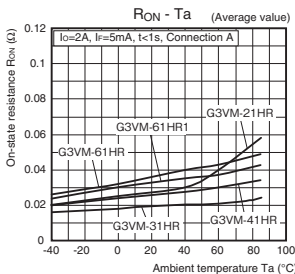

Turn ON, Turn OFF time vs. LED forward current

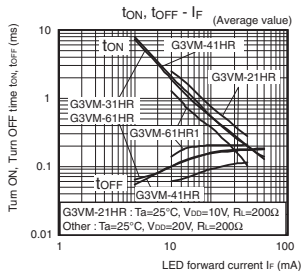

Continuous load current vs. Ambient temperature

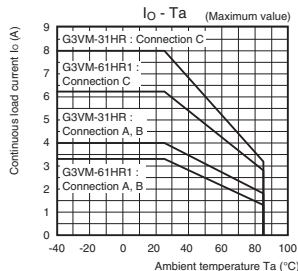

Continuous load current vs. On-state voltage

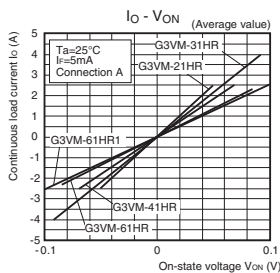

Trigger LED forward current vs. Ambient temperature

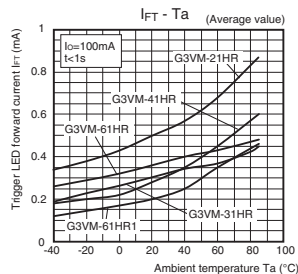

G3VM-21HR/41HR/61HR

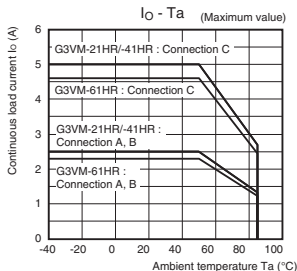

G3VM-21HR/31HR/41HR/61HR/61HR1 MOS FET Relays

Engineering Data

Turn ON, Turn OFF time vs. Ambient temperature

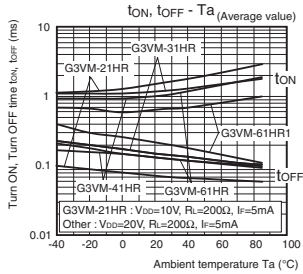

Current leakage vs. Load voltage

G3VM-21HR/41HR/61HR

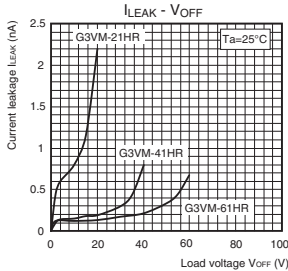

Current leakage vs. Ambient temperature

G3VM-31HR/61HR1

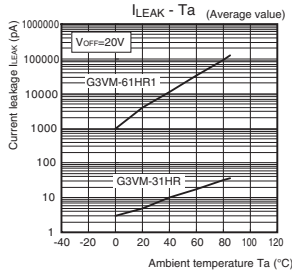

Output terminal capacitance vs. Load voltage

G3VM-21HR/41HR/61HR

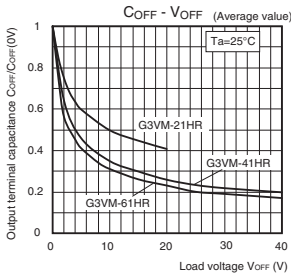

G3VM-21HR/31HR/41HR/61HR/61HR1 MOS FET Relays

■ Appearance / Terminal Arrangement / Internal Connections

● Appearance

SOP (Small Outline Package)

SOP 6-pin

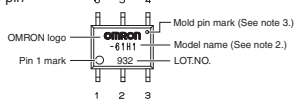

- Note:** 1. The actual product is marked differently from the image shown here.
Note: 2. "G3VM" does not appear in the model number on the Relay.
Note: 3. The indentation in the corner diagonally opposite from the pin 1 mark is from a pin on the mold.

● Terminal Arrangement/Internal Connections (Top View)

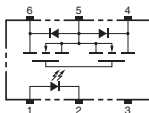

■ Dimensions (Unit: mm)



Surface-mounting Terminals

Weight: 0.13 g

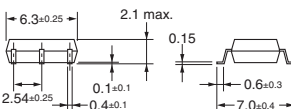
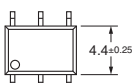

Actual Mounting Pad Dimensions

(Recommended Value, Top View)

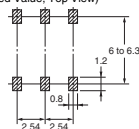

Note: The actual product is marked differently from the image shown here.

■ Approved Standards

UL recognized 

Approved Standards	Contact form	File No.
UL (recognized)	1a (SPST-NO)	E80555

■ Safety Precautions

- Refer to the *Common Precautions for All MOS FET Relays* for precautions that apply to all MOS FET Relays.

G3VM-81HR/101HR/101HR1

MOS FET Relays SOP 6-pin, High-current and Low-ON-resistance Type

MOS FET Relays in SOP 6-pin packages that achieve the low ON resistance and high switching capacitance of a mechanical relay

- Load voltage: 80 V/100 V
- 80-V Relay: Continuous load current of 1.25 A (2.5 A) max. *
- 100-V Relay: Continuous load current of 2 A (4 A) max. *

* Values in parentheses are for connection C.

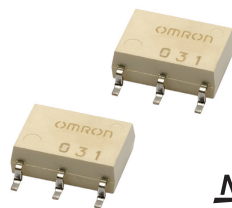
**NEW**

Note: The actual product is marked differently from the image shown here.

RoHS Compliant

Application Examples

- Semiconductor test equipment
- Security equipment
- Amusement equipment
- Communication equipment
- Industrial equipment
- Test & Measurement equipment
- Power circuit

Package (Unit : mm, Average)

SOP 6-pin

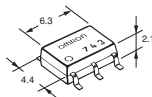

Note: The actual product is marked differently from the image shown here.

Model Number Legend

G3VM-□□□□□
1 2 3 4 5

- 1. Load Voltage**
8 : 80 V
10 : 100 V
- 2. Contact form**
1 : 1a (SPST-NO)
- 3. Package**
H : SOP 6-pin
- 4. Additional functions**
R : Low ON resistance
- 5. Other informations**
When specifications overlap, serial code is added in the recorded order.

Ordering Information

Package	Contact form	Terminals	Load voltage (peak value) *	Continuous load current (peak value) *		Stick packaging		Tape packaging	
				Connection A, B	Connection C	Model	Minimum package quantity	Model	Minimum package quantity
SOP6	1a (SPST-NO)	Surface-mounting Terminals	80 V	1.25 A	2.5 A	G3VM-81HR	75	G3VM-81HR(TR)	2,500
			100 V	1.4 A	2.8 A	G3VM-101HR		G3VM-101HR(TR)	2,500
			100 V	2.0 A	4.0 A	G3VM-101HR1		G3VM-101HR1(TR05)	500

* The AC peak and DC value are given for the load voltage and continuous load current.

Note: To order tape packaging for Relays with surface-mounting terminals, add "(TR)" to the end of the model number.

G3VM-81HR/101HR/101HR1

MOS FET Relays

■ Absolute Maximum Ratings (Ta = 25°C)

Item	Symbol	G3VM-81HR	G3VM-101HR	G3VM-101HR1	Unit	Measurement conditions		
Input	LED forward current	IF	50	30		mA		
	LED forward current reduction rate	$\Delta I_F/^\circ\text{C}$	-0.5	-0.3		mA/°C	Ta $\geq 25^\circ\text{C}$	
	LED reverse voltage	Vr	5			V		
	Connection temperature	TJ	125			°C		
Output	Load voltage (AC peak/DC)	V _{OFF}	80	100		V		
	Continuous load current	Connection A	Io	1250	1400	2000	mA	Connection A: AC peak/DC Connection B and C: DC
		Connection B		2500	2800	4000		
		Connection C						
	ON current reduction rate	Connection A	$\Delta I_o/^\circ\text{C}$	-12.5	-18.7	-20	mA/°C	G3VM-101HR : Ta $\geq 50^\circ\text{C}$ Others : Ta $\geq 25^\circ\text{C}$
		Connection B		-25.0	-37.3	-40		
		Connection C						
	Pulse ON current	I _{op}	3.75	4	6	A	t=100 ms, Duty=1/10	
	Connection temperature	TJ	125			°C		
	Dielectric strength between I/O *	V _{I-O}	1500			V _{rms}	AC for 1 min	
Ambient operating temperature	Ta	-20 to +85	-40 to +85		°C	With no icing or condensation		
Ambient storage temperature	T _{stg}	-40 to +125	-55 to +125		°C			
Soldering temperature	—	260			°C	10 s		

* The dielectric strength between the input and output was checked by applying voltage between all pins as a group on the LED side and all pins as a group on the light-receiving side.

Connection Diagram

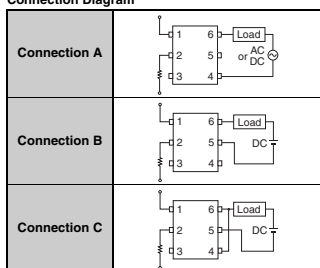

DIP

SOP

SSOP

USOP

VSON

S-VSON

G3VM-81HR/101HR/101HR1

G3VM-81HR/101HR/101HR1

MOS FET Relays

Electrical Characteristics (Ta = 25°C)

Item		Symbol	G3VM-81HR	G3VM-101HR	G3VM-101HR1	Unit	Measurement conditions	
Input	LED forward voltage	V _F	Minimum	1.0	1.18	V	I _F =10 mA	
			Typical	1.15	1.33			
			Maximum	1.3	1.48			
	Reverse current	I _R	Maximum	10		μA	V _R =5 V	
	Capacitance between terminals	C _T	Typical	15	70	pF	V=0, f=1 MHz	
Trigger LED forward current	I _{FT}	Typical	2	0.4	mA	G3VM-81HR : I _o =1250 mA Others : I _o =100 mA		
		Maximum	5	3				
Release LED forward current	I _{FC}	Minimum	0.2	0.1	0.1	mA	I _{OFF} =10 μA	
Output	Maximum resistance with output ON	R _{ON}	Typical	Connection A	0.11	0.1	0.045	G3VM-81HR : I _F =5 mA, I _o = Continuous load current ratings G3VM-101HR/101HR1 : I _F =5 mA, I _o = Continuous load current ratings, t < 1 s
				Connection B	0.06	0.05	0.022	
				Connection C	0.03	0.025	0.011	
			Maximum	Connection A	0.15	0.2	0.07	
				Connection B	0.08	0.1	0.035	
				Connection C	0.04	-	0.018	
Current leakage when the relay is open	I _{LEAK}	Typical	1.2	-	-	nA	G3VM-81HR : V _{OFF} =20 V, Ta=50°C Others : V _{OFF} = Load voltage ratings	
		Maximum	1.5	10	1000			
Capacitance between terminals	C _{OFF}	Typical	460	1000	500	pF	G3VM-81HR : V=0, f=100 MHz Others : V=0, f=1 MHz	
		Maximum	1000	-	-			
Capacitance between I/O terminals	C _{I-O}	Typical	0.8		pF		f=1 MHz, V _S =0 V	
Insulation resistance between I/O terminals	R _{I-O}	Minimum	1000			MΩ	V _{I-O} =500 VDC, RoHS=60%	
		Typical	10 ⁸					
Turn-ON time	t _{ON}	Typical	2.0	1.0	1.1	ms	I _F =5 mA, R _L =200 Ω, V _{DD} =20 V *	
		Maximum	3.0	5.0				
Turn-OFF time	t _{OFF}	Typical	0.7	0.15	0.1	ms	I _F =5 mA, R _L =200 Ω, V _{DD} =20 V *	
		Maximum	1.0					

* Turn-ON and Turn-OFF Times

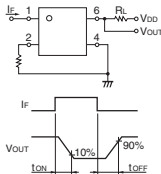

Recommended Operating Conditions

For usage with high reliability, Recommended Operation Conditions is a measure that takes into account the derating of Absolute Maximum Ratings and Electrical Characteristics.

Each item on this list is an independent condition, so it is not simultaneously satisfy several conditions.

Item	Symbol	G3VM-81HR	G3VM-101HR	G3VM-101HR1	Unit	
Load voltage (AC peak/DC)	V _{DD}	Maximum	64	100	80	V
		Minimum	5			
Operating LED forward current	I _F	Typical	-	7.5	10	mA
		Maximum	30	20	25	
		Maximum	1250	1100	2000	
Continuous load current (AC peak/DC)	I _o	Maximum	1250	1100	2000	mA
		Minimum	25	-	-20	
		Maximum	60	-	65	
Ambient operating temperature	T _a	Minimum	25	-20	°C	
		Maximum	60	65		

Spacing and Insulation

Item	Minimum	Unit
Creepage distances	4.0	mm
Clearance distances	4.0	
Internal isolation thickness	0.1	

G3VM-81HR/101HR/101HR1

MOS FET Relays

Engineering Data

LED forward current vs. Ambient temperature

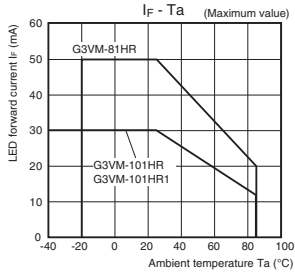

LED forward current vs. LED forward voltage

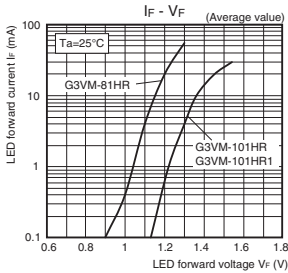

On-state resistance vs. Ambient temperature

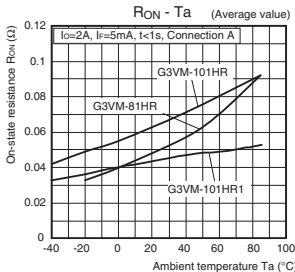

Turn ON, Turn OFF time vs. LED forward current

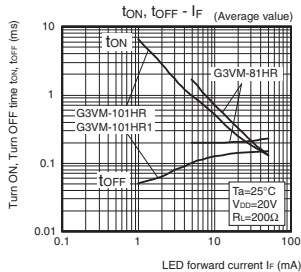

Continuous load current vs. Ambient temperature

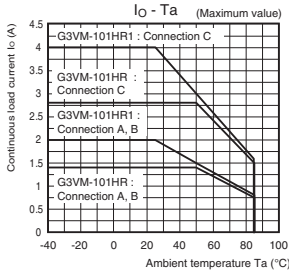

Continuous load current vs. On-state voltage

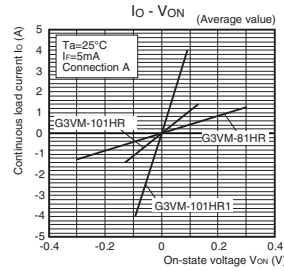

Trigger LED forward current vs. Ambient temperature

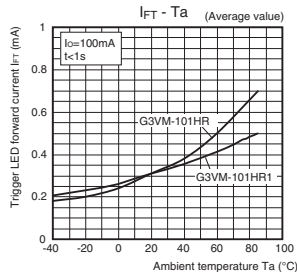

G3VM-81HR

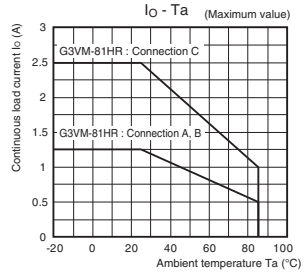

G3VM-81HR

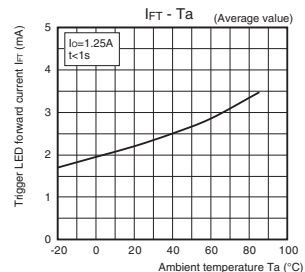

G3VM-81HR/101HR/101HR1

MOS FET Relays

Engineering Data

Turn ON, Turn OFF time vs. Ambient temperature

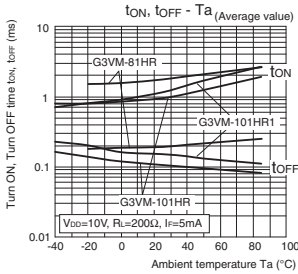

Current leakage vs. Load voltage

G3VM-101HR

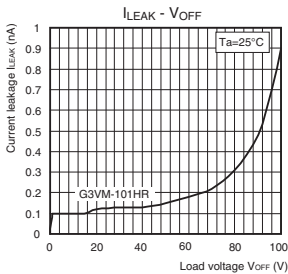

Current leakage vs. Ambient temperature

G3VM-81HR/101HR1

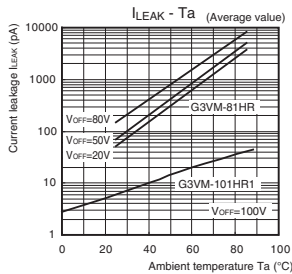

Output terminal capacitance vs. Load voltage

G3VM-101HR

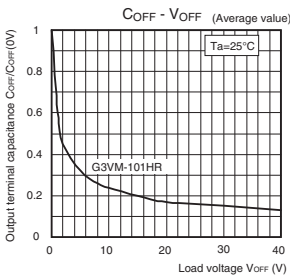

Introduction

General purpose

High load voltage

Multi-contact pair (2a, 2b, and 1a1)

High current and Low ON-resistance

Small and High dielectric strength

High dielectric strength

Current limiting

Low output impedance and ON-resistance

Small and High Standoff voltage

Certified Models with Standards Certification

DIP

SOP

SSOP

USOP

VSON

S-VSON

G3VM-81HR/101HR/101HR1

G3VM-81HR/101HR/101HR1

MOS FET Relays

■ Appearance / Terminal Arrangement / Internal Connections

● Appearance

SOP (Small Outline Package)

SOP 6-pin

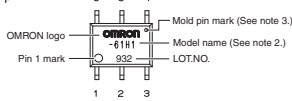

- Note:** 1. The actual product is marked differently from the image shown here.
Note: 2. "G3VM" does not appear in the model number on the Relay.
Note: 3. The indentation in the corner diagonally opposite from the pin 1 mark is from a pin on the mold.

● Terminal Arrangement/Internal Connections (Top View)

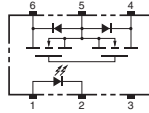

■ Dimensions (Unit: mm)



Surface-mounting Terminals

Weight: 0.13 g

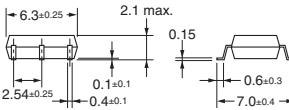
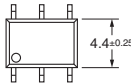

Actual Mounting Pad Dimensions

(Recommended Value, Top View)

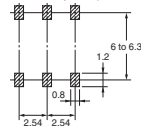

Note: The actual product is marked differently from the image shown here.

■ Approved Standards

UL recognized 

Approved Standards	Contact form	File No.
UL (recognized)	1a (SPST-NO)	E80555

■ Safety Precautions

- Refer to the *Common Precautions for All MOS FET Relays* for precautions that apply to all MOS FET Relays.

G3VM-31QR/61QR2/101QR1

MOS FET Relays S-VSON 4-pin, High-current and Low-ON-resistance Type

World's smallest * class New S-VSON Package

- Load voltage 30 V/60 V/100 V.
- 30-V Relay: Continuous load current of 1.5 A max.
- 60-V Relay: Continuous load current of 1.0 A max.
- 100-V Relay: Continuous load current of 0.65 A max.
- High Ambient operating temperature: -40°C to +110°C

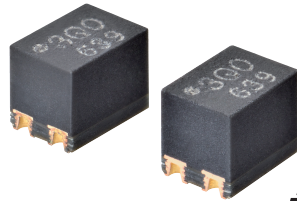

NEW

Note: The actual product is marked differently from the image shown here.

* As of March 2018 Survey by OMRON.

RoHS Compliant

Application Examples

- Semiconductor test equipment
- Test & measurement equipment
- Communication equipment
- Data loggers

Package (Unit : mm, Average)

S-VSON4 pin

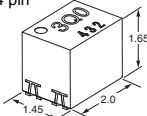

Note: The actual product is marked differently from the image shown here.

Model Number Legend

G3VM-□□□□□
1 2 3 4 5

1. Load Voltage

- 3: 30 V
- 6: 60 V
- 10: 100 V

4. Additional functions

- R: Low On-resistance

2. Contact form Package type

- 1: 1a (SPST-NO)

5. Other informations

When specifications overlap, serial code is added in the recorded order.

3. Package type

- Q: S-VSON 4 pin

Ordering Information

Package type	Contact form	Terminals	Load voltage (peak value) *	Continuous load current (peak value) *	Packing/Tape cut		Packing/Tape & reel	
					Model	Minimum package quantity	Model	Minimum package quantity
S-VSON4	1a (SPST-NO)	Surface-mounting Terminals	30 V	1,500 mA	G3VM-31QR	1 pc.	G3VM-31QR (TR05)	500 pcs.
			60 V	1,000 mA	G3VM-61QR2		G3VM-61QR2 (TR05)	
			100 V	650 mA	G3VM-101QR1		G3VM-101QR1 (TR05)	

* The AC peak and DC value are given for the load voltage and continuous load current.

Note: When ordering tape packing, add "(TR05)" (500 pcs/reel) to the model number.

Ask your OMRON representative for orders under 500 pcs. We can supply products with the tape already cut.

Tape-cut S-VSON is packaged without humidity resistance. Use manual soldering to mount them.

Refer to common precautions.

Introduction
General purpose
High-side-voltage
Multi-contact pair (2a, 2b, and 1a1)
High current and Low-ON-resistance
Small and high-impedance strength
High-dielectric strength
Current-limiting
Low-ohmic-resistance and Low-ON-resistance
Small and High-side-voltage
Certified Models with Standards Derivation
DIP
SOP
SSOP
USOP
VSON
S-VSON
G3VM-31QR/61QR2/101QR1

G3VM-31QR/61QR2/101QR1

MOS FET Relays

Absolute Maximum Ratings (Ta = 25°C)

Item	Symbol	G3VM-31QR	G3VM-61QR2	G3VM-101QR1	Unit	Measurement conditions	
Input	LED forward current	IF	30		mA		
	LED forward current reduction rate	$\Delta I_F/^\circ\text{C}$	-0.3		mA/°C	Ta \geq 25°C	
	LED reverse voltage	VR	5		V		
Connection temperature	TJ	125		°C			
Output	Load voltage (AC peak/DC)	V _{OFF}	30	60	100	V	
	Continuous load current (AC peak/DC)	IO	1500	1000	650	mA	
	ON current reduction rate	$\Delta I_O/^\circ\text{C}$	-15	-10	-6.5	mA/°C	Ta \geq 25°C
	Pulse ON current	I _{OP}	4.5	3	2	A	t _{ON} 100 ms, Duty=1/10
	Connection temperature	TJ	125		°C		
	Dielectric strength between I/O *	V _{I-O}	500		V _{rms}	AC for 1 min	
	Ambient operating temperature	Ta	-40 to +110		°C		
Ambient storage temperature	T _{stg}	-40 to +125		°C	With no icing or condensation		
Soldering temperature	-	260		°C	10 s		

* The dielectric strength between the input and output was checked by applying voltage between all pins as a group on the LED side and all pins as a group on the light-receiving side.

Electrical Characteristics (Ta = 25°C)

Item	Symbol	G3VM-31QR	G3VM-61QR2	G3VM-101QR1	Unit	Measurement conditions	
Input	LED forward voltage	Minimum	1.1		V	I _F =10 mA	
		Typical	1.21				
		Maximum	1.4				
Reverse current	I _R	Maximum		10	μA	V _R =5 V	
Capacity between terminals	C _T	Typical		30	pF	V=0, f=1 MHz	
Trigger LED forward current	I _{FT}	Typical	0.6	0.7	mA	I _O =100 mA	
		Maximum	3				
Release LED forward current	I _{FC}	Minimum		0.1	mA	I _{OFF} =10 μA	
Maximum resistance with output ON	R _{ON}	Typical	0.1	0.2	0.4	Ω	G3VM-31QR/61QR2, I _O =1000 mA, I _F =5 mA, t _c <1 s G3VM-101QR1, I _O =650 mA, I _F =5 mA, t _c <1 s
		Maximum	0.2	0.3	0.6		
Current leakage when the relay is open	I _{LEAK}	Maximum		1	1000 (1)	nA	G3VM-31QR : V _{OFF} =20 V G3VM-61QR2 : V _{OFF} =60 V (V _{OFF} =50 V) G3VM-101QR1 : V _{OFF} =100 V (V _{OFF} =80 V)
Capacity between terminals	C _{OFF}	Typical	120	80	50	pF	V=0, f=100 MHz, t<1 s
		Maximum	-	150	-		
Capacity between I/O terminals	C _{I-O}	Typical		1	0.9	pF	f=1 MHz, V _S =0 V
Insulation resistance between I/O terminals	R _{I-O}	Typical		10 ⁸		MΩ	V _{I-O} =500 VDC, R _{oH} ≤60%
Turn-ON time	t _{ON}	Typical	0.8	0.75	0.6	ms	I _F =5 mA, R _L =200 Ω, V _{DD} =20 V *
		Maximum	2				
Turn-OFF time	t _{OFF}	Typical	0.05	0.04		ms	I _F =5 mA, R _L =200 Ω, V _{DD} =20 V *
		Maximum	1	0.3			

* Turn-ON and Turn-OFF Times



Recommended Operating Conditions

For usage with high reliability, Recommended Operation Conditions is a measure that takes into account the derating of Absolute Maximum Ratings and Electrical Characteristics.

Each item on this list is an independent condition, so it is not simultaneously satisfy several conditions.

Item	Symbol	G3VM-31QR	G3VM-61QR2	G3VM-101QR1	Unit	
Load voltage (AC peak/DC)	V _{DD}	Maximum	24	48	80	V
Operating LED forward current	I _F	Minimum	5		mA	
		Typical	7.5			
		Maximum	20			
Continuous load current (AC peak/DC)	I _O	Maximum	1300	1000	650	
		Minimum	-20			
Ambient operating temperature	Ta	Maximum		100	°C	

G3VM-31QR/61QR2/101QR1

MOS FET Relays

Engineering Data

●LED forward current vs. Ambient temperature

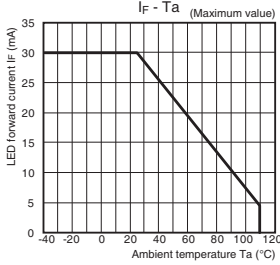

●Continuous load current vs. Ambient temperature

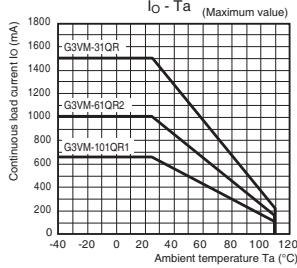

●LED forward current vs. LED forward voltage

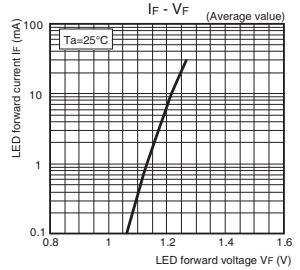

●Continuous load current vs. On-state voltage

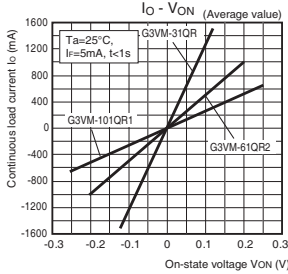

●On-state resistance vs. Ambient temperature

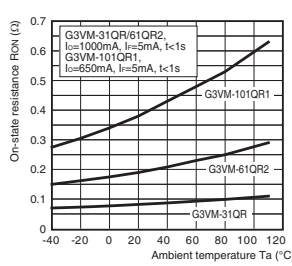

●Trigger LED forward current vs. Ambient temperature

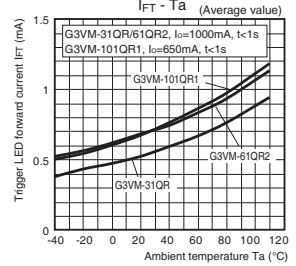

●Turn ON, Turn OFF time vs. LED forward current

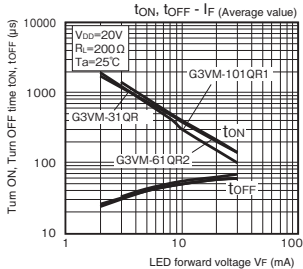

●Turn ON, Turn OFF time vs. Ambient temperature

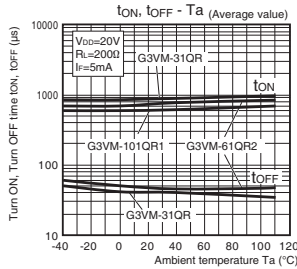

●Current leakage vs. Load voltage

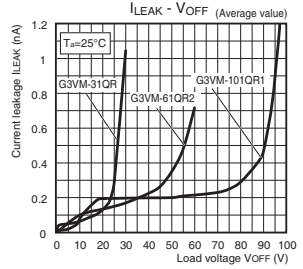

●Current leakage vs. Ambient temperature

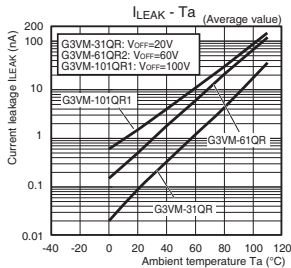

●Output terminal capacitance vs. Load voltage

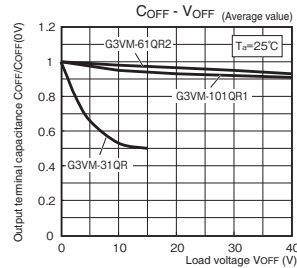

Introduction
 General purpose
 High-side-voltage
 Multi-contact pair
 (2A, 2b, and 1a1b)
 Low-voltage resistance
 High-current and high-dielectric strength
 Small and high-strength
 High-dielectric strength
 Current-limiting
 Low-voltage-resistance load-voltage
 Small and High-Standards Derivation
 Certified Models with
 VSON
 DIP
 SOP
 SSOP
 USOP
 VSON
 S-VSON
 G3VM-31QR/61QR2/101QR1

G3VM-31QR/61QR2/101QR1

MOS FET Relays

■ Appearance / Terminal Arrangement / Internal Connections

■ Appearance

S-VSON (Super-Very Small Outline Non-leaded)

S-VSON4 pin

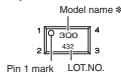

* Actual model name marking for each model

Model	Marking
G3VM-31QR	3Q0
G3VM-61QR2	6Q2
G3VM-101QR1	AQ1

■ Terminal Arrangement/Internal Connections (Top View)

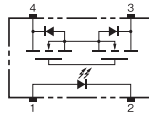

- Note 1. The actual product is marked differently from the image shown here.
2. "G3VM" does not appear in the model number on the Relay.

■ Dimensions (Unit: mm)

Surface-mounting Terminals

Weight: 0.01 g

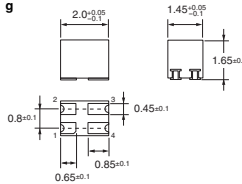
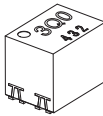

Note: The actual product is marked differently from the image shown here.

Actual Mounting Pad Dimensions

(Recommended Value, Top View)

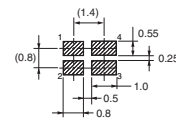

Unless otherwise specified, the dimensional tolerance is ± 0.1 mm.

■ Safety Precautions

- Refer to "Common Precautions" for all G3VM models.

G3VM-□AY□/□DY□

MOS FET Relays DIP 4-pin, Small and High-dielectric-strength Type

Small DIP 4-pin package with Dielectric Strength of 5,000 VAC between I/O

- Load voltage: 40 V, 60 V, 200 V, 350 V, 400 V, or 600 V
- Standard type: Trigger LED forward current 3 mA (max.)
- High sensitive type: Trigger LED forward current 2 mA (max.)



Note: The actual product is marked differently from the image shown here.

RoHS Compliant

Application Examples

- Electrical power unit
- Security equipment
- Medical equipment
- Test & measurement equipment
- Industrial equipment

Package (Unit : mm, Average)

DIP 4-pin

PCB Terminals

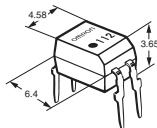

Surface-mounting Terminals

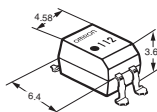

Note: The actual product is marked differently from the image shown here.

Model Number Legend

G3VM-□□□□□
1 2 3 4 5

1. Load Voltage

- 4: 40 V
- 6: 60 V
- 20: 200 V
- 35: 350 V
- 40: 400 V
- 60: 600 V

2. Contact form

- 1: 1a (SPST-NO)

4. Additional functions

- Y: Dielectric strength between I/O above 2,500 V type

3. Package

- A: DIP4 pin PCB terminals
- D: DIP4 pin Surface-mounting Terminals

5. Other informations

- When specifications overlap, serial code is added in the recorded order.

G3VM-□AY□/□DY□

MOS FET Relays

■ Ordering Information

● Standard type

Package	Contact form	Load voltage (peak value) *	Continuous load current (peak value) *	Stick packaging			Tape packaging	
				Model		Minimum package quantity	Model	Minimum package quantity
				PCB terminals	Surface-mounting Terminals		Surface-mounting Terminals	
DIP4	1a (SPST-NO)	40 V	2000 mA	G3VM-41AY1	G3VM-41DY1	100 pcs.	G3VM-41DY1 (TR05)	500 pcs.
		60 V	500 mA	G3VM-61AY1	G3VM-61DY1		G3VM-61DY1 (TR05)	
		200 V	250 mA	G3VM-201AY1	G3VM-201DY1		G3VM-201DY1 (TR05)	
		350 V	100 mA	G3VM-351AY1	G3VM-351DY1		G3VM-351DY1 (TR05)	
		400 V	120 mA	G3VM-401AY1	G3VM-401DY1		G3VM-401DY1 (TR05)	
		600 V	90 mA	G3VM-601AY1	G3VM-601DY1		G3VM-601DY1 (TR05)	

* The AC peak and DC value are given for the load voltage and continuous load current.

Note: To order tape packaging for Relays with surface-mounting terminals, add "(TR05)" to the end of the model number.

● High sensitive type

Package	Contact form	Load voltage (peak value) *	Continuous load current (peak value) *	Stick packaging			Tape packaging	
				Model		Minimum package quantity	Model	Minimum package quantity
				PCB terminals	Surface-mounting Terminals		Surface-mounting Terminals	
DIP4	1a (SPST-NO)	40 V	2000 mA	G3VM-41AY	G3VM-41DY	100 pcs.	G3VM-41DY (TR)	1,500 pcs.
		60 V	500 mA	G3VM-61AY	G3VM-61DY		G3VM-61DY (TR)	
		200 V	250 mA	G3VM-201AY	G3VM-201DY		G3VM-201DY (TR)	
		350 V	100 mA	G3VM-351AY	G3VM-351DY		G3VM-351DY (TR)	
		400 V	120 mA	G3VM-401AY	G3VM-401DY		G3VM-401DY (TR)	
		600 V	90 mA	G3VM-601AY	G3VM-601DY		G3VM-601DY (TR)	

* The AC peak and DC value are given for the load voltage and continuous load current.

Note: To order tape packaging for Relays with surface-mounting terminals, add "(TR)" to the end of the model number.

■ Absolute Maximum Ratings (Ta = 25°C)

● Standard type, High sensitive type

Item	Symbol	G3VM-41AY1	G3VM-61AY1	G3VM-201AY1	G3VM-351AY1	G3VM-401AY1	G3VM-601AY1	Unit	Measurement conditions						
		G3VM-41DY1	G3VM-61DY1	G3VM-201DY1	G3VM-351DY1	G3VM-401DY1	G3VM-601DY1								
Input	LED forward current	If						30	mA						
	Repetitive peak LED forward current	IFP						1	A	100 μs pulses, 100 pps					
	LED forward current reduction rate	ΔIf/°C						-0.3	mA/°C	Ta≥25°C					
	LED reverse voltage	Vr						5	V						
Output	Connection temperature	Tj						125	°C						
	Load voltage (AC peak/DC)	V _{OFF}		40	60	200	350	400	600	V					
	Continuous load current (AC peak/DC)	I _o		2,000	500	250	100	120	90	mA					
	ON current reduction rate	ΔI _o /°C						-20	-5	-2.5	-1	-1.2	-0.9	mA/°C	Ta≥25°C
	Pulse ON current	I _{op}		6	1.5	0.75	0.3	0.36	0.27	A	t=100 ms, Duty=1/10				
	Connection temperature	Tj						125	°C						
	Dielectric strength between I/O *	V _{I-O}						5,000	V _{rms}	AC for 1 min					
Ambient operating temperature	Ta						-40 to +85	°C	With no icing or condensation						
Ambient storage temperature	Tstg						-55 to +125	°C							
Soldering temperature	-						260	°C	10 s						

* The dielectric strength between the input and output was checked by applying voltage between all pins as a group on the LED side and all pins as a group on the light-receiving side.

G3VM-□AY□/□DY□

MOS FET Relays

■Electrical Characteristics (Ta = 25°C)

●Standard type

Item	Symbol	Symbol	G3VM-41AY1	G3VM-61AY1	G3VM-201AY1	G3VM-351AY1	G3VM-401AY1	G3VM-601AY1	Unit	Measurement conditions
			G3VM-41DY1	G3VM-61DY1	G3VM-20DY1	G3VM-35DY1	G3VM-40DY1	G3VM-60DY1		
Input	LED forward voltage	Minimum	1.1						V	If=10 mA
		Typical	1.27							
		Maximum	1.4							
	Reverse current	IR	10						μA	Vr=5 V
	Capacitance between terminals	Ct	50						pF	V=0, f=1 MHz
Output	Trigger LED forward current	Typical	0.5	0.6				0.5	mA	G3VM-41AY1/DY1 : Io=1 A Others : Io=Continuous load current ratings
		Maximum	3							
	Release LED forward current	Ifc	0.1						mA	Ioff=10 μA
	Maximum resistance with output ON	Ron	Typical	0.09 (0.06)	0.6	5	35 (25)	22 (17)	45 (30)	Ω
Maximum	0.15 (0.10)	2	8	50 (35)	35 (28)	60 (40)				
Current leakage when the relay is open	Ileak	Maximum	1						μA	Voff=Load voltage ratings
Capacitance between terminals	Coff	Typical	300	130	90	30	80	75	pF	V=0, f=1 MHz
Capacitance between I/O terminals	Ci-o	Typical	0.8						pF	f=1 MHz, Vs=0 V
Insulation resistance between I/O terminals	Ri-o	Minimum	1000						MΩ	Vi-o=500 VDC, RoHs=60%
		Typical	10 ⁸							
Turn-ON time	ton	Typical	2.8	1	0.3		0.6	0.5	ms	G3VM-41AY1/DY1 : Rl=200 Ω, If=10 mA, VDD=20 V G3VM-601AY1/DY1 : Rl=200 Ω, If=5 mA, VDD=10 V Others : Rl=200 Ω, If=5 mA, VDD=20 V *
		Maximum	5	3		2				
Turn-OFF time	toff	Typical	0.3	0.2	0.1		0.2		ms	
		Maximum	1							

* Turn-ON and Turn-OFF Times



●High sensitive type

Item	Symbol	Symbol	G3VM-41AY	G3VM-61AY	G3VM-201AY	G3VM-351AY	G3VM-401AY	G3VM-601AY	Unit	Measurement conditions
			G3VM-41DY	G3VM-61DY	G3VM-20DY	G3VM-35DY	G3VM-40DY	G3VM-60DY		
Input	LED forward voltage	Minimum	1.45						V	If=10 mA
		Typical	1.63							
		Maximum	1.75							
	Reverse current	IR	10						μA	Vr=5 V
	Capacitance between terminals	Ct	40						pF	V=0, f=1 MHz
Output	Trigger LED forward current	Typical	0.3						mA	G3VM-41AY/DY : Io=1 A Others : Io=Continuous load current ratings
		Maximum	2							
	Release LED forward current	Ifc	0.1						mA	Ioff=10 μA
Maximum resistance with output ON	Ron	Typical	0.09 (0.06)	0.6	5	35 (25)	22 (17)	45 (30)	Ω	If=5 mA, Io=Continuous load current ratings Values in parentheses are for t < 1 s.
		Maximum	0.15 (0.10)	2	8	50 (35)	35 (28)	60 (40)		
Current leakage when the relay is open	Ileak	Maximum	1						μA	Voff=Load voltage ratings
Capacitance between terminals	Coff	Typical	300	130	90	30	80	75	pF	V=0, f=1 MHz
Capacitance between I/O terminals	Ci-o	Typical	0.8						pF	f=1 MHz, Vs=0 V
Insulation resistance between I/O terminals	Ri-o	Minimum	1000						MΩ	Vi-o=500 VDC, RoHs=60%
		Typical	10 ⁸							
Turn-ON time	ton	Typical	2	0.5	0.1		0.2		ms	G3VM-601AY/DY : Rl=200 Ω, If=5 mA, VDD=10 V Others : Rl=200 Ω, If=5 mA, VDD=20 V *
		Maximum	5	1						
Turn-OFF time	toff	Typical	0.3	0.2				ms		
		Maximum	1							

* Turn-ON and Turn-OFF Times

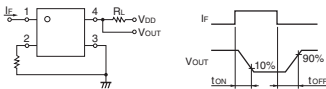

G3VM-□AY□/□DY□

MOS FET Relays

Recommended Operating Conditions

For usage with high reliability, Recommended Operation Conditions is a measure that takes into account the derating of Absolute Maximum Ratings and Electrical Characteristics.

Each item on this list is an independent condition, so it is not simultaneously satisfy several conditions.

Standard type

Item	Symbol		G3VM-41AY1	G3VM-61AY1	G3VM-201AY1	G3VM-351AY1	G3VM-401AY1	G3VM-601AY1	Unit
			G3VM-41DY1	G3VM-61DY1	G3VM-201DY1	G3VM-351DY1	G3VM-401DY1	G3VM-601DY1	
Load voltage (AC peak/DC)	V _{DD}	Maximum	32	48	160	280	320	480	V
		Minimum	5						
Operating LED forward current	I _F	Typical	7.5						mA
		Maximum	25						
		Maximum	2000	500	250	100	120	90	
Ambient operating temperature	T _a	Minimum	-20						°C
		Maximum	65						

High sensitive type

Item	Symbol		G3VM-41AY	G3VM-61AY	G3VM-201AY	G3VM-351AY	G3VM-401AY	G3VM-601AY	Unit
			G3VM-41DY	G3VM-61DY	G3VM-201DY	G3VM-351DY	G3VM-401DY	G3VM-601DY	
Load voltage (AC peak/DC)	V _{DD}	Maximum	32	48	160	280	320	480	V
		Minimum	3						
Operating LED forward current	I _F	Typical	5						mA
		Maximum	15		20				
		Maximum	2000	500	250	100	120	90	
Ambient operating temperature	T _a	Minimum	-20						°C
		Maximum	65						

Spacing and Insulation

Standard type and High sensitive type

Item		Standard	Unit
Creepage distances	Minimum	7.0	mm
	Clearance distances	7.0	
Internal isolation thickness	Minimum	0.4	

Engineering Data

●LED forward current vs. Ambient temperature

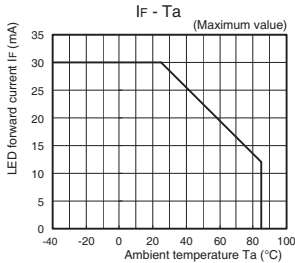

●LED forward current vs. LED forward voltage

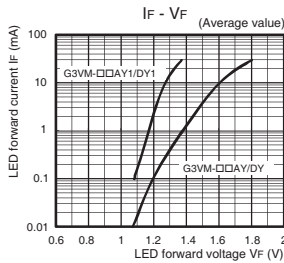

●Continuous load current vs. Ambient temperature

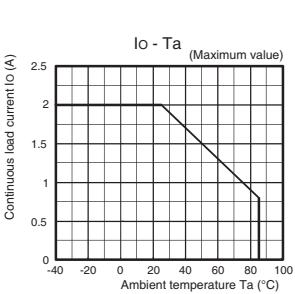

G3VM-61AY1/DY1/AY/DY G3VM-201AY1/DY1/AY/DY

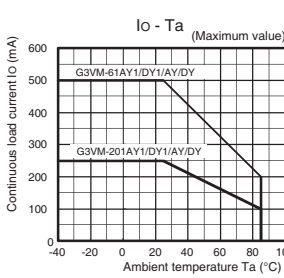

G3VM-351AY1/DY1/AY/DY G3VM-401AY1/DY1/AY/DY G3VM-601AY1/DY1/AY/DY

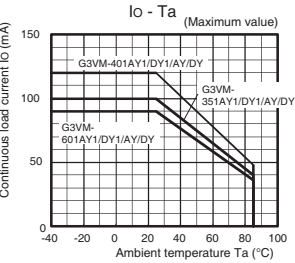

●Continuous load current vs. On-state voltage

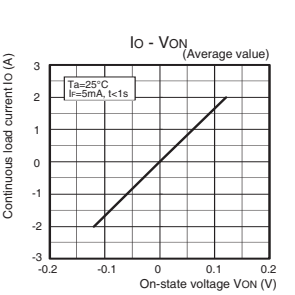

G3VM-61AY1/DY1/AY/DY G3VM-201AY1/DY1/AY/DY

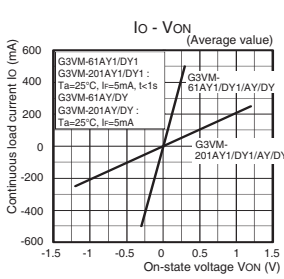

G3VM-351AY1/DY1/AY/DY G3VM-401AY1/DY1/AY/DY G3VM-601AY1/DY1/AY/DY

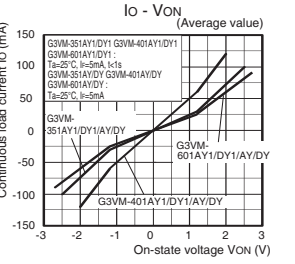

●On-state resistance vs. Ambient temperature

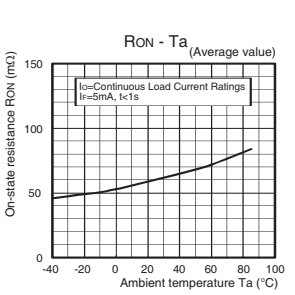

G3VM-61AY1/DY1/AY/DY G3VM-201AY1/DY1/AY/DY

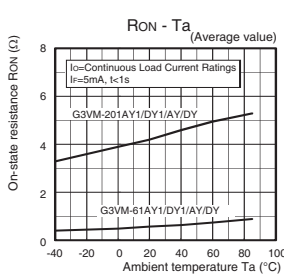

G3VM-351AY1/DY1/AY/DY G3VM-401AY1/DY1/AY/DY G3VM-601AY1/DY1/AY/DY

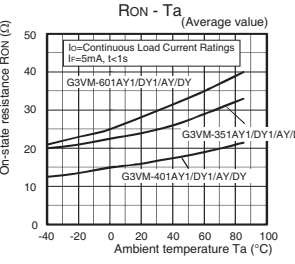

Introduction
 General purpose
 High-load-voltage
 Multi-contact pair
 Low-ON-resistance
 High-current and
 High-voltage
 Small and high-
 dielectric strength
 High-dielectric-
 strength
 Current-limiting
 Low-voltage-resistance
 and low-on-resistance
 Small and High-
 load-voltage
 Certified Models with
 Standards Certification
 DIP
 SOP
 SSOP
 USOP
 VSON
 S-VSON
 G3VM-□□AY□/□DY□

G3VM-□AY□/□DY□

MOS FET Relays

Engineering Data

● Trigger LED forward current vs. Ambient temperature

Trigger LED forward current vs. Ambient temperature
 G3VM-41AY1/DY1/AY/DY
 G3VM-61AY1/DY1/AY/DY

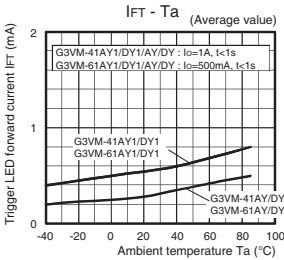

G3VM-201AY1/DY1/AY/DY
 G3VM-351AY1/DY1/AY/DY

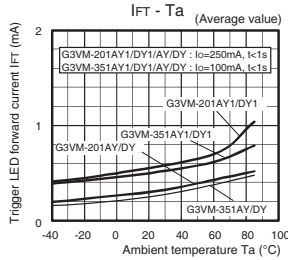

G3VM-401AY1/DY1/AY/DY
 G3VM-601AY1/DY1/AY/DY

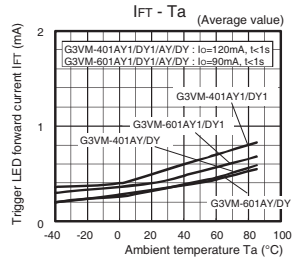

● Turn ON, Turn OFF time vs. LED forward current

Turn ON, Turn OFF time vs. LED forward current
 G3VM-41AY1/DY1
 G3VM-61AY1/DY1

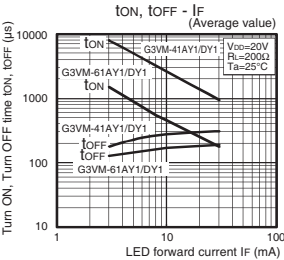

G3VM-201AY1/DY1
 G3VM-351AY1/DY1

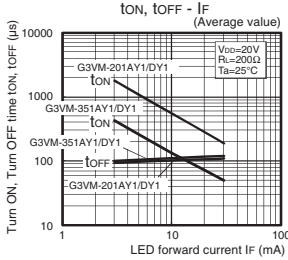

G3VM-401AY1/DY1
 G3VM-601AY1/DY1

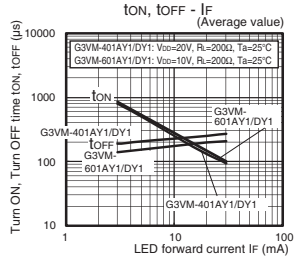

G3VM-41AY/DY
 G3VM-61AY/DY

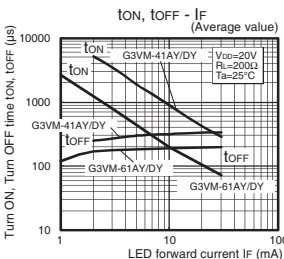

G3VM-201AY/DY
 G3VM-351AY/DY

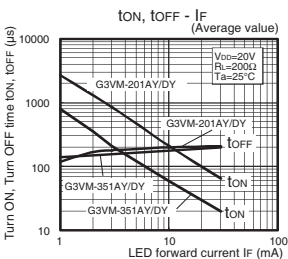

G3VM-401AY/DY
 G3VM-601AY/DY

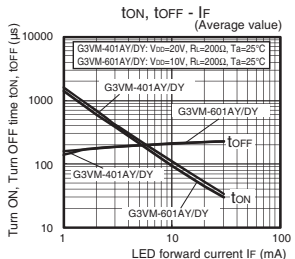

● Turn ON, Turn OFF time vs. Ambient temperature

Turn ON, Turn OFF time vs. Ambient temperature
 G3VM-41AY1/DY1
 G3VM-61AY1/DY1

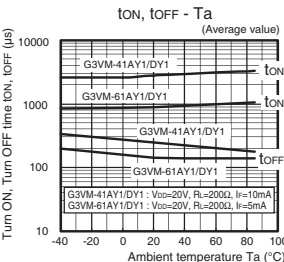

G3VM-201AY1/DY1
 G3VM-351AY1/DY1

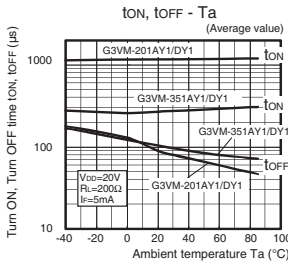

G3VM-401AY1/DY1
 G3VM-601AY1/DY1

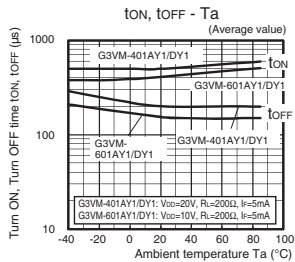

Engineering Data

Turn ON, Turn OFF time vs.

Ambient temperature

G3VM-41AY/DY
G3VM-61AY/DY

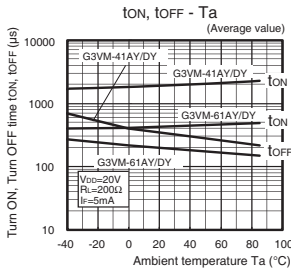

G3VM-201AY/DY
G3VM-351AY/DY

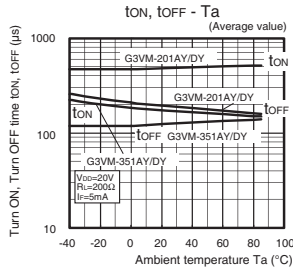

G3VM-401AY/DY
G3VM-601AY/DY

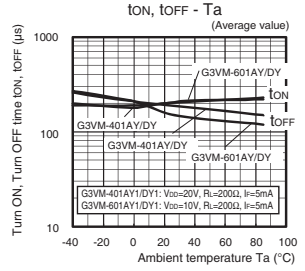

Current leakage vs.

Ambient temperature

G3VM-41AY1/DY1/AY/DY
G3VM-61AY1/DY1/AY/DY

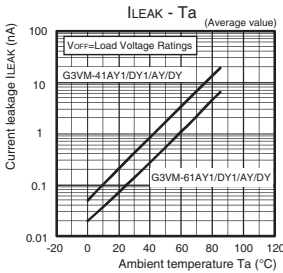

G3VM-201AY1/DY1/AY/DY
G3VM-351AY1/DY1/AY/DY

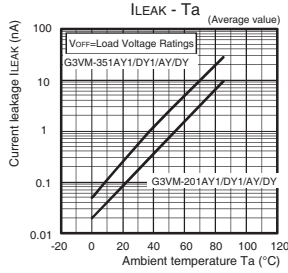

G3VM-401AY1/DY1/AY/DY
G3VM-601AY1/DY1/AY/DY

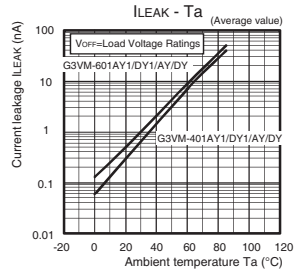

G3VM-□AY□/□DY□

MOS FET Relays

■ Appearance Terminal Arrangement Internal Connections

● Appearance

● Terminal Arrangement/Internal Connections

DIP (Dual Inline Package)

DIP 4-pin

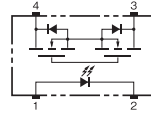
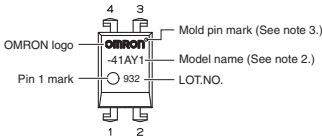
**Note:** 1. The actual product is marked differently from the image shown here.**Note:** 2. "G3VM" does not appear in the model number on the Relay.**Note:** 3. The indentation in the corner diagonally opposite from the pin 1 mark is from a pin on the mold.

■ Dimensions (Unit: mm)



PCB Terminals

Weight: 0.25 g

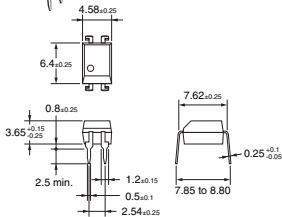

Surface-mounting Terminals

Weight: 0.25 g

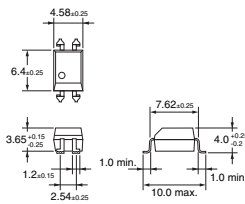

PCB Dimensions (BOTTOM VIEW)

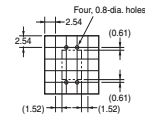

Actual Mounting Pad Dimensions

(Recommended Value, TOP VIEW)

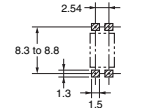
**Note:** The actual product is marked differently from the image shown here.

■ Approved Standards

UL recognized 

● Standard type and High sensitive type

Approved Standards	Contact form	File No.
UL recognized	1a (SPST-NO)	E80555

■ Safety Precautions

- Refer to the *Common Precautions for All MOS FET Relays* for precautions that apply to all MOS FET Relays.

DIP

SOP

SSOP

USOP

VSON

S-VSON

G3VM-□AY□/□DY□

G3VM-□BY/□EY

MOS FET Relays DIP 6-pin, High-dielectric-strength Type

MOS FET Relays in DIP 6-pin packages that achieve a dielectric strength of 5,000 VAC between I/O

- Load voltage: 400 V or 600 V

RoHS Compliant

Application Examples

- Electrical power unit
- Industrial equipment
- Test & Measurement equipment
- Medical equipment
- Security equipment

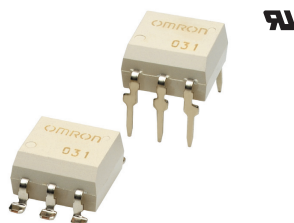

Note: The actual product is marked differently from the image shown here.

Package (Unit : mm, Average)

DIP 6-pin
PCB Terminals

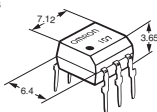

Surface-mounting Terminals

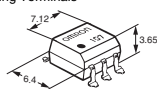

Note: The actual product is marked differently from the image shown here.

Model Number Legend

G3VM-□□□□□
1 2 3 4 5

- Load Voltage**
40 : 400 V
60 : 600 V
- Contact form**
1 : 1a (SPST-NO)
- Package**
B : DIP 6-pin with PCB terminals
E : DIP 6-pin with surface-mounting terminals
- Additional functions**
Y : Dielectric strength between I/O above 2,500 V type
- Other informations**
When specifications overlap, serial code is added in the recorded order.

Ordering Information

Package	Contact form	Load voltage (peak value) *	Continuous load current (peak value) *		Stick packaging			Tape packaging	
			Connection A, B	Connection C	Model	Minimum package quantity	Model	Minimum package quantity	
DIP6	1a (SPST-NO)	400 V	120 mA	240 mA	G3VM-401BY	G3VM-401EY	50 pcs.	G3VM-401EY(TR)	1,500 pcs.
		600 V	100 mA	200 mA	G3VM-601BY	G3VM-601EY		G3VM-601EY(TR)	

* The AC peak and DC value are given for the load voltage and continuous load current.

Note: To order tape packaging for Relays with surface-mounting terminals, add "(TR)" to the end of the model number.

Absolute Maximum Ratings (Ta = 25°C)

Item	Symbol	G3VM-401BY G3VM-401EY	G3VM-601BY G3VM-601EY	Unit	Measurement conditions	
Input	LED forward current	If	50	mA		
	Repetitive peak LED forward current	I _{FP}	1	A	100 μs pulses, 100 pps	
	LED forward current reduction rate	ΔI _F /°C	-0.5	mA/°C	Ta ≥ 25°C	
	LED reverse voltage	V _R	5	V		
	Connection temperature	T _J	125	°C		
Output	Load voltage (AC peak/DC)		400	600	V	
	Continuous load current	Connection A	120	100	mA	Connection A: AC peak/DC Connection B and C: DC
		Connection B				
		Connection C	240	200		
	ON current reduction rate	Connection A	-1.2	-1.0	mA/°C	Ta ≥ 25°C
		Connection B	-2.4	-2.0		
		Connection C	20	35		
Connection temperature	T _J	125	°C			
Dielectric strength between I/O *	V _{I-O}	5000	Vrms	AC for 1 min		
Ambient operating temperature	Ta	-40 to +85	°C	With no icing or condensation		
Ambient storage temperature	T _{stg}	-55 to +125	°C			
Soldering temperature	-	260	°C	10 s		

* The dielectric strength between the input and output was checked by applying voltage between all pins as a group on the LED side and all pins as a group on the light-receiving side.

Connection Diagram

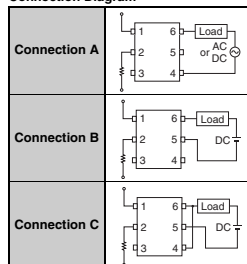

G3VM-□BY/□EY

MOS FET Relays

■Electrical Characteristics (Ta = 25°C)

Item		Symbol	G3VM-401BY G3VM-401EY	G3VM-601BY G3VM-601EY	Unit	Measurement conditions		
Input	LED forward voltage	V _F	Minimum	1	V	I _F =10 mA		
			Typical	1.15				
			Maximum	1.3				
	Reverse current	I _R	Maximum	10	μA	V _R =5 V		
	Capacitance between terminals	C _T	Typical	30	pF	V=0, f=1 MHz		
Trigger LED forward current	I _{FT}	Typical	—	1.6	mA	I _o =Continuous load current ratings		
		Maximum	3	5				
Output	Maximum resistance with output ON	R _{ON}	Typical	Connection A	17	30 (25)	Ω	G3VM-401BY/EY : I _F =5 mA, I _o =120 mA G3VM-601BY/EY : I _F =10 mA, I _o =100 mA Values in parentheses are for t < 1 s. G3VM-401BY/EY : I _F =5 mA, I _o =120 mA G3VM-601BY/EY : I _F =10 mA, I _o =100 mA G3VM-401BY/EY : I _F =5 mA, I _o =240 mA G3VM-601BY/EY : I _F =10 mA, I _o =200 mA Values in parentheses are for t < 1 s. G3VM-401BY/EY : I _F =5 mA, I _o =120 mA G3VM-601BY/EY : I _F =10 mA, I _o =100 mA G3VM-401BY/EY : I _F =5 mA, I _o =240 mA G3VM-601BY/EY : I _F =10 mA, I _o =200 mA
				Connection B	11	23		
				Connection C	6	12		
			Maximum	Connection A	35	45 (35)		
				Connection B	20	35		
				Connection C	10	18		
	Current leakage when the relay is open	I _{LEAK}	Maximum	1	μA	V _{OFF} =Load voltage ratings		
Capacitance between terminals	C _{OFF}	Typical	40	120	pF	V=0, f=1 MHz		
Capacitance between I/O terminals	C _{I-O}	Typical	0.8		pF	f=1 MHz, V _S =0 V		
Insulation resistance between I/O terminals	R _{I-O}	Minimum	1000		MΩ	V _{I-O} =500 VDC, RoHS60%		
		Typical	10 ⁶					
Turn-ON time	t _{ON}	Typical	0.3	0.2	ms	G3VM-401BY/EY : I _F =5 mA, I _o =120 mA, R _L =200Ω, V _{oD} =20V * G3VM-601BY/EY : I _F =10 mA, I _o =100 mA, R _L =200Ω, V _{oD} =20V *		
		Maximum	1.0	1.5				
Turn-OFF time	t _{OFF}	Typical	0.1	0.2	ms			
		Maximum	1.0					

* Turn-ON and Turn-OFF Times

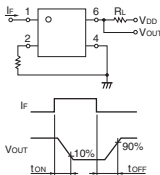

■Recommended Operating Conditions

For usage with high reliability, Recommended Operation Conditions is a measure that takes into account the derating of Absolute Maximum Ratings and Electrical Characteristics.

Each item on this list is an independent condition, so it is not simultaneously satisfy several conditions.

Item	Symbol	G3VM-401BY G3VM-401EY	G3VM-601BY G3VM-601EY	Unit
Load voltage (AC peak/DC)	V _{DD}	Maximum 320 Minimum 5	480 7.5	V
Operating LED forward current	I _F	Typical	7.5	15
		Maximum	25	
Continuous load current (AC peak/DC)	I _o	Maximum 120	100	
Ambient operating temperature	T _a	Minimum	-20	°C
		Maximum	65	

■Spacing and Insulation

Item	Minimum	Unit
Creepage distances	7.0	mm
Clearance distances	7.0	
Internal isolation thickness	0.4	

G3VM-□BY/□EY

MOS FET Relays

Engineering Data

● LED forward current vs. Ambient temperature

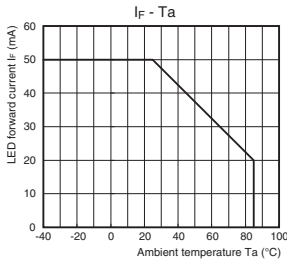

● Continuous load current vs. Ambient temperature

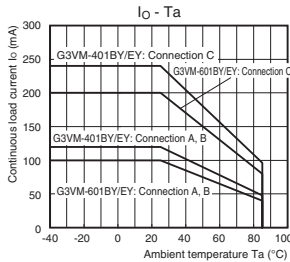

● LED forward current vs. LED forward voltage

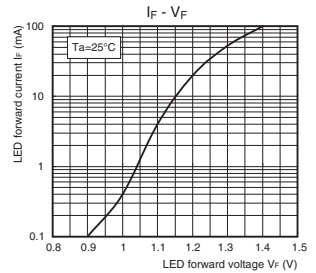

● Continuous load current vs. On-state voltage

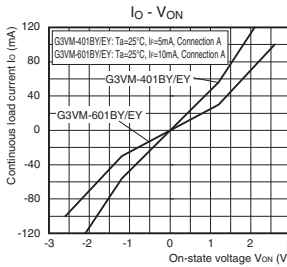

● On-state resistance vs. Ambient temperature

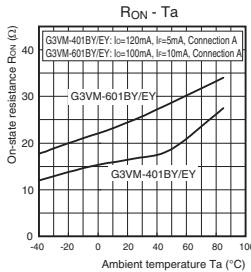

● Trigger LED forward current vs. Ambient temperature

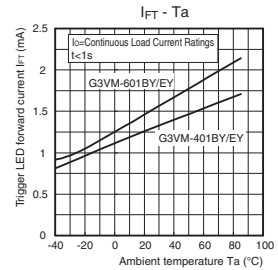

● Turn ON, Turn OFF time vs. LED forward current

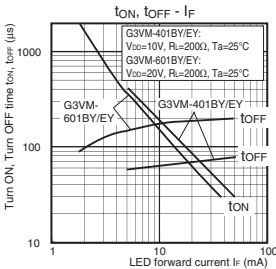

● Turn ON, Turn OFF time vs. Ambient temperature

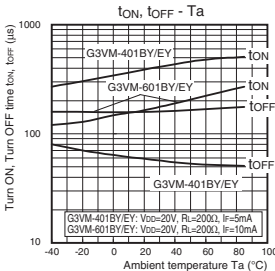

● Current leakage vs. Ambient temperature

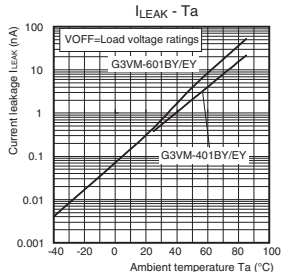

G3VM-□L/□FL/□GL

MOS FET Relays Current-limiting Type

MOS FET Relays that protect themselves from overcurrents with a current-limiting protection function

- Package: DIP 4-pin, DIP 8-pin or SOP 4-pin
- Contact form: 1a (SPST-NO) or 2a (DPST-NO)
- Load voltage: 350 V
- Current limit: 150 to 300 mA

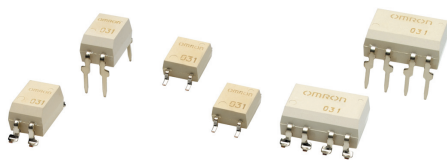

Note: The actual product is marked differently from the image shown here.

RoHS Compliant

Application Examples

- Communication equipment
- Industrial equipment
- Test & Measurement equipment

Package

(Unit : mm, Average)

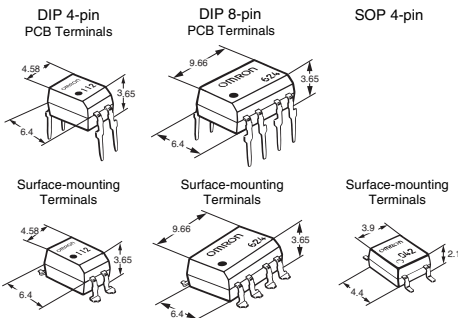

Note: The actual product is marked differently from the image shown here.

Model Number Legend

G3VM-□□□□
1 2 3 4

- Load Voltage**
35 : 350 V
- Contact form**
1 : 1a (SPST-NO)
- Package**
G : SOP 4-pin with surface-mounting terminals
- Additional functions**
L : Current limiting

Note: The model number legend for the G3VM-2L/2FL/WL/WFL is different from the above legend.

Ordering Information

Package	Contact form	Load voltage (peak value) *	Continuous load current (peak value) *	Stick packaging			Tape packaging	
				Model		Minimum package quantity	Model	Minimum package quantity
				PCB Terminals	Surface-mounting Terminals			
DIP4	1a (SPST-NO)	350 V	120 mA	G3VM-2L	G3VM-2FL	100 pcs.	G3VM-2FL(TR)	1,500 pcs.
DIP8	2a (DPST-NO)			G3VM-WL	G3VM-WFL	50 pcs.	G3VM-WFL(TR)	1,500 pcs.
SOP4	1a (SPST-NO)			-	G3VM-351GL	100 pcs.	G3VM-351GL(TR)	2,500 pcs.

* The AC peak and DC value are given for the load voltage and continuous load current.

Note: To order tape packaging for Relays with surface-mounting terminals, add "(TR)" to the end of the model number.

G3VM-□L/□FL/□GL

MOS FET Relays

■ Absolute Maximum Ratings (Ta = 25°C)

Item	Symbol	G3VM-2L G3VM-2FL	G3VM-WL G3VM-WFL	G3VM-351GL	Unit	Measurement conditions
Input	LED forward current	IF	50		mA	
	Repetitive peak LED forward current	IFP	1		A	100 μs pulses, 100 pps
	LED forward current reduction rate	ΔIf/°C	-0.5		mA/°C	Ta ≥ 25°C
	LED reverse voltage	VR	6	5	V	
	Connection temperature	TJ	125		°C	
Output	Load voltage (AC peak/DC)	V _{OFF}	350		V	
	Continuous load current (AC peak/DC)	Io	120		mA	
	ON current reduction rate	ΔIo/°C	-1.2		mA/°C	Ta ≥ 25°C
	Connection temperature	TJ	125		°C	
	Dielectric strength between I/O *	V _{I-O}	2500	1500	V _{rms}	AC for 1 min
	Ambient operating temperature	Ta	-40 to +85		°C	With no icing or condensation
	Ambient storage temperature	Tstg	-55 to +125		°C	
Soldering temperature	—	260		°C	10 s	

* The dielectric strength between the input and output was checked by applying voltage between all pins as a group on the LED side and all pins as a group on the light-receiving side.

■Electrical Characteristics (Ta = 25°C)

Item		Symbol	G3VM-2L G3VM-2FL	G3VM-WL G3VM-WFL	G3VM-351GL	Unit	Measurement conditions	
Input	LED forward voltage	V _F	Minimum	1.0		V	I _F =10 mA	
			Typical	1.15				
			Maximum	1.3				
	Reverse current	I _R	Maximum	10		μA	G3VM-2L/2FL/WL/WFL : V _R =6 V G3VM-351GL : V _R =5 V	
	Capacitance between terminals	C _T	Typical	30		pF	V=0, f=1 MHz	
Output	Trigger LED forward current	I _{FT}	Maximum	3		mA	I _O =120 mA	
	Release LED forward current	I _{FC}	Minimum	0.1		mA	G3VM-2L/2FL/WL/WFL : I _{OFF} =10 μA G3VM-351GL : I _{OFF} =100 μA	
	Maximum resistance with output ON	R _{ON}	Typical	22	15		Ω	I _F =5 mA, I _O =120 mA
			Maximum	35				
	Current leakage when the relay is open	I _{LEAK}	Maximum	1.0		μA	V _{OFF} =350 V	
Capacitance between terminals	C _{OFF}	Typical	40	70		pF	V=0, f=1 MHz	
Limit current	I _{LM}	Minimum	150		mA	I _F =5 mA, V _{DD} =5 V, t=5 ms		
		Maximum	300					
Capacitance between I/O terminals	C _{I-O}	Typical	0.8		pF	f=1 MHz, V _S =0 V		
Insulation resistance between I/O terminals	R _{I-O}	Minimum	1000		MΩ	V _{I-O} =500 VDC, R _{oH} ≤60%		
		Typical	10 ⁸					
Turn-ON time	t _{ON}	Typical	-		0.3	ms	I _F =5 mA, R _L =200 Ω, V _{DD} =2 V *	
		Maximum	1.0					
Turn-OFF time	t _{OFF}	Typical	-		0.1	ms	I _F =5 mA, R _L =200 Ω, V _{DD} =2 V *	
		Maximum	1.0					

* Turn-ON and Turn-OFF Times

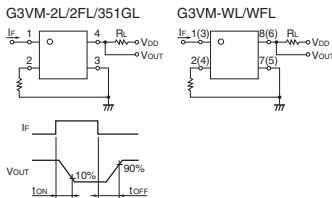

■Recommended Operating Conditions

For usage with high reliability, Recommended Operation Conditions is a measure that takes into account the derating of Absolute Maximum Ratings and Electrical Characteristics.

Each item on this list is an independent condition, so it is not simultaneously satisfy several conditions.

Item	Symbol		G3VM-2L G3VM-2FL	G3VM-WL G3VM-WFL	G3VM-351GL	Unit
Load voltage (AC peak/DC)	V _{DD}	Maximum	280			V
		Minimum	5			
Operating LED forward current	I _F	Minimum	5			mA
		Typical	7.5			
		Maximum	25			
Continuous load current (AC peak/DC)	I _O	Maximum	100			A
Ambient operating temperature	T _a	Minimum	-20			°C
		Maximum	65			

■Spacing and Insulation

Item	Minimum		Unit
	G3VM-□L/□FL	G3VM-□GL	
Creepage distances	7.0	2.5	mm
Clearance distances	7.0	2.5	
Internal isolation thickness	0.4	0.1	

Engineering Data

LED forward current vs. Ambient temperature

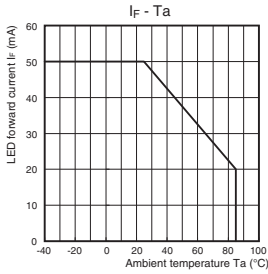

Continuous load current vs. On-state voltage

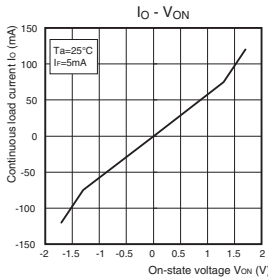

Turn ON, Turn OFF time vs. LED forward current

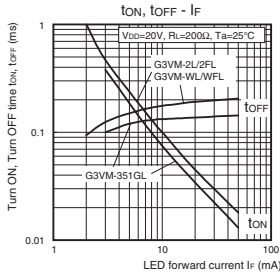

Continuous load current vs. Ambient temperature

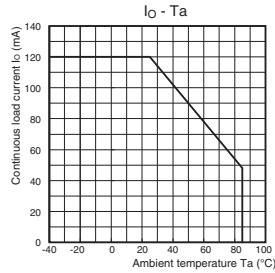

On-state resistance vs. Ambient temperature

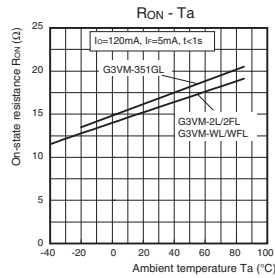

Turn ON, Turn OFF time vs. Ambient temperature

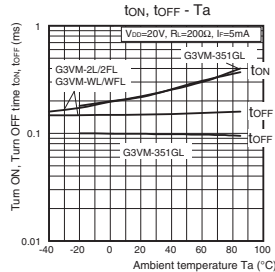

LED forward current vs. LED forward voltage

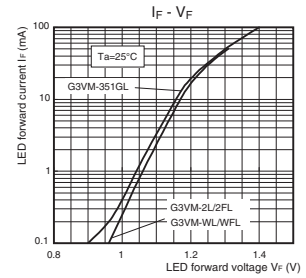

Trigger LED forward current vs. Ambient temperature

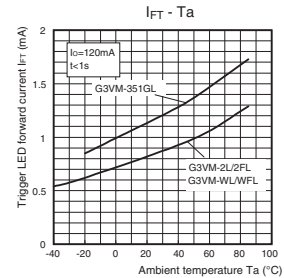

Current leakage vs. Ambient temperature

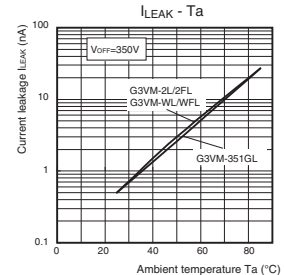

G3VM-□L/□FL/□GL

MOS FET Relays

■ Appearance / Terminal Arrangement / Internal Connections

● Appearance

DIP (Dual In-line Package)

DIP 4-pin

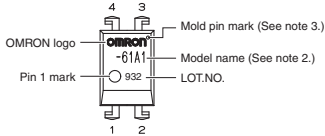

DIP 8-pin

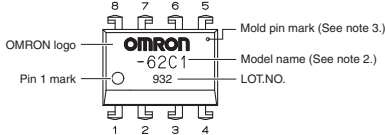

SOP (Small Outline Package)

SOP 4-pin

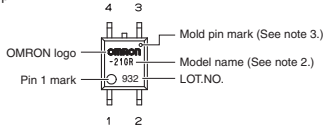
**Note: 1.** The actual product is marked differently from the image shown here.**Note: 2.** "G3VM" does not appear in the model number on the Relay.**Note: 3.** The indentation in the corner diagonally opposite from the pin 1 mark is from a pin on the mold.

● Terminal Arrangement/Internal Connections (Top View)

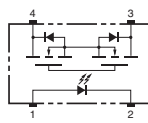
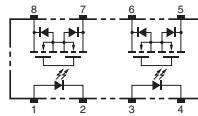
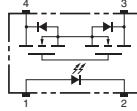

■ Dimensions (Unit: mm)

G3VM-2L

PCB Terminals

Weight: 0.4 g

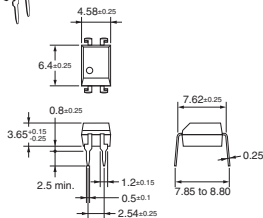

G3VM-2FL

Surface-mounting Terminals

Weight: 0.4 g

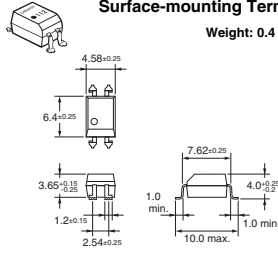

PCB Dimensions (BOTTOM VIEW)

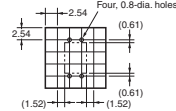

Actual Mounting Pad Dimensions (Recommended Value, TOP VIEW)

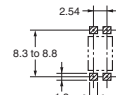
**Note:** The actual product is marked differently from the image shown here.

G3VM-WL

PCB Terminals

Weight: 0.54 g

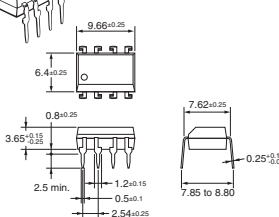

G3VM-WFL

Surface-mounting Terminals

Weight: 0.54 g

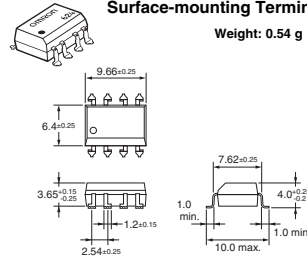

PCB Dimensions (BOTTOM VIEW)

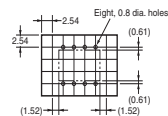

Actual Mounting Pad Dimensions (Recommended Value, TOP VIEW)

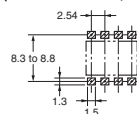
**Note:** The actual product is marked differently from the image shown here.Introduction
General purpose
High-voltage
Multi-contact pair (2a, 2b, and 1a1)
High-current and Low-Ohm resistance
Small and high-impedance strength
High-dielectric strength
Current limiting
Low-ohmic-resistance and low-voltage
Small and High-impedance strength
Certified Models with Standards Certification

G3VM-□L/□FL/□GL

DIP

SOP

SSOP

USOP

VSON

S-VSON

G3VM-□L/□FL/□GL

MOS FET Relays

■Dimensions (Unit: mm)

G3VM-351GL



Surface-mounting Terminals

Weight: 0.1 g

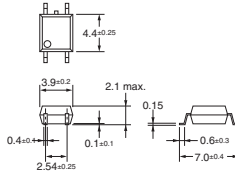

Actual Mounting Pad Dimensions (Recommended Value, TOP VIEW)

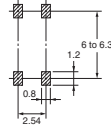

Note: The actual product is marked differently from the image shown here.

■Approved Standards

UL recognized 

Model	Approved Standards	Contact form	File No.
G3VM-2L G3VM-2FL	UL (recognized)	1a (SPST-NO)	E80555
G3VM-WL G3VM-WFL		2a (DPST-NO)	

■Safety Precautions

- Refer to the *Common Precautions for All MOS FET Relays* for precautions that apply to all MOS FET Relays.

G3VM-21GR□/41GR4/41GR5/41GR6/81GR□

MOS FET Relays SOP 4-pin, Low-output-capacitance and Low-ON-resistance Type (with Low $C \times R$)

MOS FET Relays in SOP 4-pin packages that achieve a low $C \times R$

- Load voltage: 20 V, 40 V, or 80 V
- G3VM-21GR: Low $C \times R = 5 \text{ pF} \cdot \Omega$, C_{OFF} (standard) = 1 pF, R_{ON} (standard) = 5 Ω
- G3VM-21GR1: Low $C \times R = 5 \text{ pF} \cdot \Omega$, C_{OFF} (standard) = 5 pF, R_{ON} (standard) = 1 Ω
- G3VM-41GR6: Low $C \times R = 10 \text{ pF} \cdot \Omega$, C_{OFF} (standard) = 1 pF, R_{ON} (standard) = 10 Ω
- G3VM-41GR4: Low $C \times R = 10 \text{ pF} \cdot \Omega$, C_{OFF} (standard) = 5 pF, R_{ON} (standard) = 2 Ω
- G3VM-41GR5: Low $C \times R = 10 \text{ pF} \cdot \Omega$, C_{OFF} (standard) = 10 pF, R_{ON} (standard) = 1 Ω

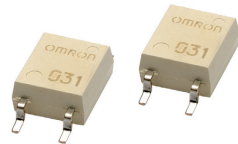

Note: The actual product is marked differently from the image shown here.

RoHS Compliant

Application Examples

- Semiconductor test equipment
- Security equipment
- Amusement equipment
- Test & Measurement equipment
- Industrial equipment
- Communication equipment
- Power circuit

Package

(Unit : mm, Average)

SOP 4-pin

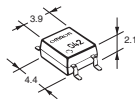

Note: The actual product is marked differently from the image shown here.

Model Number Legend

G3VM-□□□□□
1 2 3 4 5

1. Load Voltage
2: 20 V
4: 40 V
8: 80 V
2. Contact form
1: 1a (SPST-NO)
3. Package
G: SOP 4-pin
4. Additional functions
R: Low ON resistance
5. Other informations

When specifications overlap, serial code is added in the recorded order.

Ordering Information

Package	Contact form	Terminals	Load voltage (peak value) *	Continuous load current (peak value) *	Stick packaging		Tape packaging	
					Model	Minimum package quantity	Model	Minimum package quantity
SOP4	1a (SPST-NO)	Surface-mounting Terminals	20 V	160 mA	G3VM-21GR	100 pcs.	G3VM-21GR(TR)	2,500 pcs.
				300 mA	G3VM-21GR1		G3VM-21GR1(TR)	
			40 V	120 mA	G3VM-41GR6		G3VM-41GR6(TR)	
				250 mA	G3VM-41GR4		G3VM-41GR4(TR)	
			80 V	300 mA	G3VM-41GR5		G3VM-41GR5(TR)	
				40 mA	G3VM-81GR		G3VM-81GR(TR)	
	200 mA	G3VM-81GR1	G3VM-81GR1(TR)					

* The AC peak and DC value are given for the load voltage and continuous load current.

Note: To order tape packaging for Relays with surface-mounting terminals, add "(TR)" to the end of the model number.

Absolute Maximum Ratings ($T_a = 25^\circ\text{C}$)

Item	Symbol	G3VM-21GR	G3VM-21GR1	G3VM-41GR6	G3VM-41GR4	G3VM-41GR5	G3VM-81GR	G3VM-81GR1	Unit	Measurement conditions	
Input	LED forward current	I_F			50				mA		
	LED forward current reduction rate	$\Delta I_F/\text{C}$			-0.5				mA/°C	$T_a \geq 25^\circ\text{C}$	
	LED reverse voltage	V_R			5				V		
	Connection temperature	T_J			125				°C		
Output	Load voltage (AC peak/DC)	V_{OFF}	20		40		80		V		
	Continuous load current (AC peak/DC)	I_O	160	300	120	250	300	40	200	mA	
	ON current reduction rate	$\Delta I_O/\text{C}$	-1.6	-3.0	-1.2	-2.5	-3.0	-0.4	-2.0	mA/°C	$T_a \geq 25^\circ\text{C}$
	Pulse ON current	I_{OP}	480	900	360	750	900	120	600	mA	$t=100 \text{ ms}$, $Duty=1/10$
	Connection temperature	T_J			125					°C	
	Dielectric strength between I/O *	$V_{I/O}$			1500					Vrms	AC for 1 min
	Ambient operating temperature	T_a			-20 to +85					°C	With no icing or condensation
	Ambient storage temperature	T_{stg}	-40 to +125		-55 to +125			-40 to +125		°C	
	Soldering temperature	-			260					°C	10 s

* The dielectric strength between the input and output was checked by applying voltage between all pins as a group on the LED side and all pins as a group on the light-receiving side.

Introduction
General purpose
High-side voltage
Multi-contact pair
High-current and
Low-ON-resistance
Small and high-
high-dielectric-
strength
Current-limiting
Low-voltage
Small and High-
side voltage
Certified Models with
standards derivation

G3VM-21GR□/41GR4/41GR5/41GR6/81GR□ MOS FET Relays

■Electrical Characteristics (Ta = 25°C)

Item	Symbol		G3VM-21GR	G3VM-21GR1	G3VM-41GR6	G3VM-41GR4	G3VM-41GR5	G3VM-81GR	G3VM-81GR1	Unit	Measurement conditions		
Input	LED forward voltage	Minimum	1.0							V	If=10 mA		
		Typical	1.15										
		Maximum	1.3										
	Reverse current	Ir	10							μA	Vr=5 V		
	Capacitance between terminals	Ct	15							pF	V=0, f=1 MHz		
Trigger LED forward current	IFT	Maximum	4				3		mA	G3VM-21GR/21GR1/41GR4/41GR5/41GR6 : Io=100 mA G3VM-81GR : Io=40 mA G3VM-81GR1 : Io=200 mA			
Release LED forward current	IFC	Minimum	0.2				0.1		mA	IorF=10μA			
Output	Maximum resistance with output ON	Typical	5	1	10	2	1	16	5	Ω	G3VM-21GR/21GR1/41GR4/41GR5/41GR6 : If=5 mA, Io=Continuous load current ratings, t<1s G3VM-81GR/81GR1 : If=5 mA, Io=Continuous load current ratings		
		Maximum	8	1.5	15	3	1.5	25	8				
	Current leakage when the relay is open	I _{LEAK}	1							nA	G3VM-21GR/21GR1 : V _{OFF} =20 V, Ta=50°C G3VM-41GR4/41GR5/41GR6 : V _{OFF} =30 V, Ta=50°C G3VM-81GR : V _{OFF} =80 V, Ta=60°C G3VM-81GR1 : V _{OFF} =80 V, Ta=50°C		
	Capacitance between terminals	C _{OFF}	Typical	1	5	1	5	10	2.5	6.5	pF	G3VM-21GR/21GR1/41GR4/41GR5/41GR6 : V=0, f=100 MHz, t<1 s G3VM-81GR/81GR1 : V=0, f=100 MHz, t<10 s	
Maximum	2.5	12	2	7	14	3.5	11						
Capacitance between I/O terminals	C _{I-O}	Typical	0.8				0.7		pF	f=1 MHz, V _S =0 V			
Insulation resistance between I/O terminals	R _{I-O}	Minimum	1000							MΩ	V _{I-O} =500 VDC, R _{oH} ≤60%		
		Typical	10 ⁸										
Turn-ON time	t _{ON}	Typical	-							0.07	0.13	ms	G3VM-21GR/21GR1/41GR4/41GR5/41GR6 : If=10 mA, R _L =200 Ω, V _{DD} =20 V * G3VM-81GR/81GR1 : If=5 mA, R _L =200 Ω, V _{DD} =10 V *
		Maximum	0.5										
Turn-OFF time	t _{OFF}	Typical	-							0.07	0.17		
		Maximum	0.5										

* Turn-ON and Turn-OFF Times

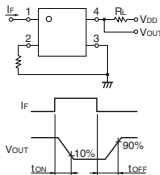

■Recommended Operating Conditions

For usage with high reliability, Recommended Operation Conditions is a measure that takes into account the derating of Absolute Maximum Ratings and Electrical Characteristics.

Each item on this list is an independent condition, so it is not simultaneously satisfy several conditions.

Item	Symbol		G3VM-21GR	G3VM-21GR1	G3VM-41GR6	G3VM-41GR4	G3VM-41GR5	G3VM-81GR	G3VM-81GR1	Unit
Load voltage (AC peak/DC)	V _{DD}	Maximum	20		32			64		V
		Minimum	7		10			5		
Operating LED forward current	If	Maximum	30		30			30		mA
		Minimum	160		300	120	250	300	40	
Continuous load current (AC peak/DC)	Io	Maximum	160		300	120	250	300	40	200
		Minimum	-		-20			-		
Ambient operating temperature	Ta	Minimum	-							°C
		Maximum	60							

■Spacing and Insulation

Item	Minimum	Unit
Creepage distances	4.0	mm
Clearance distances	4.0	
Internal isolation thickness	0.1	

G3VM-21GR□/41GR4/41GR5/41GR6/81GR□

MOS FET Relays

Engineering Data

LED forward current vs. Ambient temperature

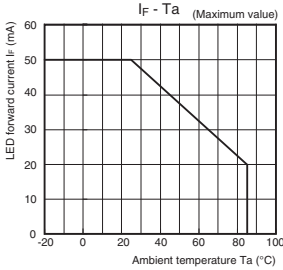

Continuous load current vs. Ambient temperature

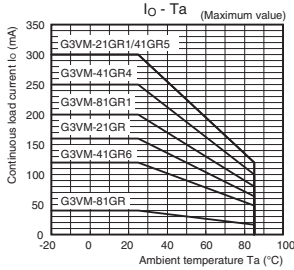

LED forward current vs. LED forward voltage

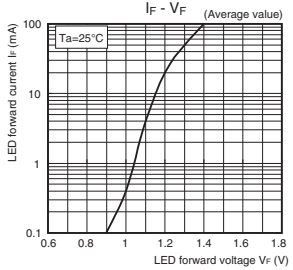

Continuous load current vs. On-state voltage

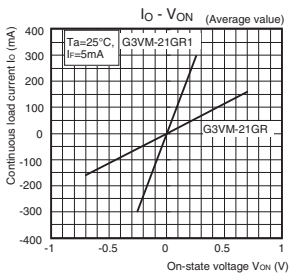

G3VM-41GR6/41GR4/41GR5

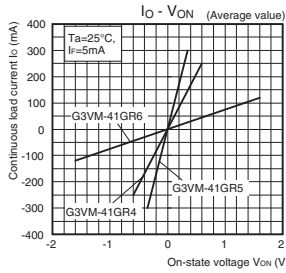

G3VM-81GR/81GR1

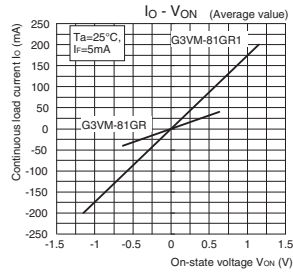

On-state resistance vs. Ambient temperature

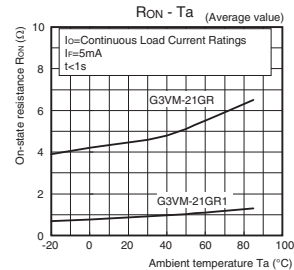

G3VM-41GR6/41GR4/41GR5

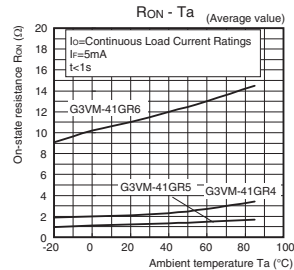

G3VM-81GR/81GR1

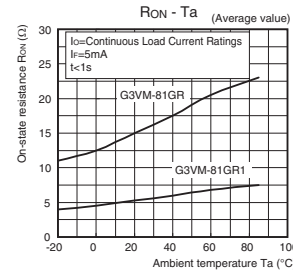

Trigger LED forward current vs. Ambient temperature

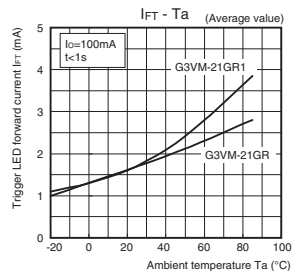

G3VM-41GR6/41GR4/41GR5

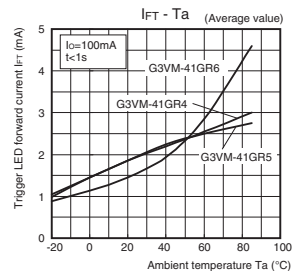

G3VM-81GR/81GR1

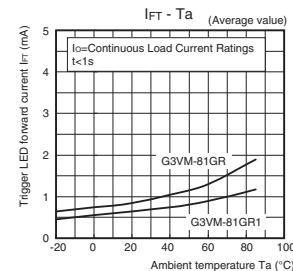

G3VM-21GR□/41GR4/41GR5/41GR6/81GR□ MOS FET Relays

Engineering Data

● Turn ON, Turn OFF time vs. LED forward current

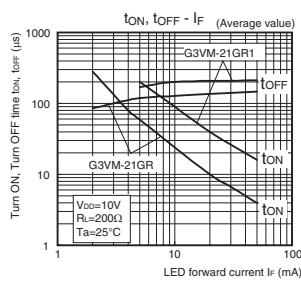

G3VM-41GR6/41GR4/41GR5

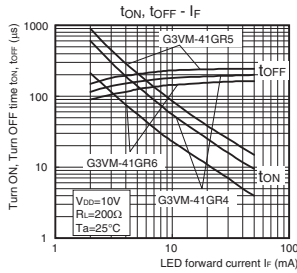

G3VM-81GR/81GR1

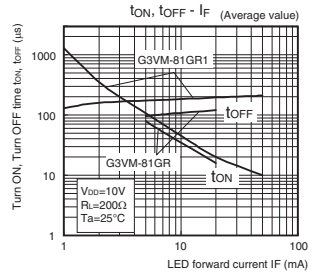

● Turn ON, Turn OFF time vs. Ambient temperature

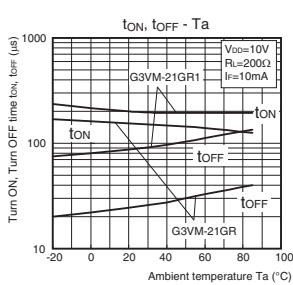

G3VM-41GR6/41GR4/41GR5

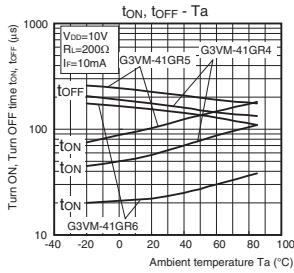

G3VM-81GR/81GR1

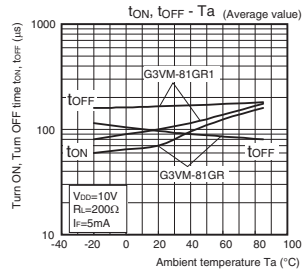

● Current leakage vs. Load voltage

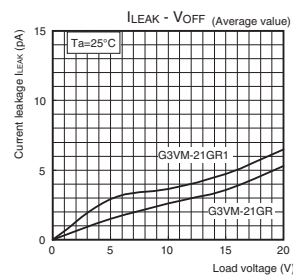

G3VM-41GR6/41GR4/41GR5

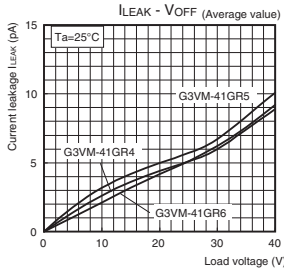

G3VM-81GR/81GR1

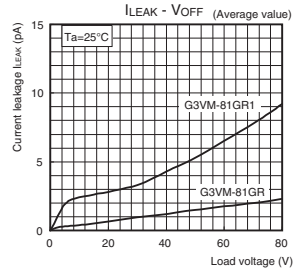

● Output terminal capacitance vs. Load voltage

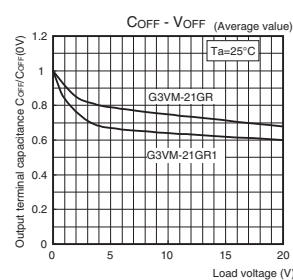

G3VM-41GR6/41GR4/41GR5

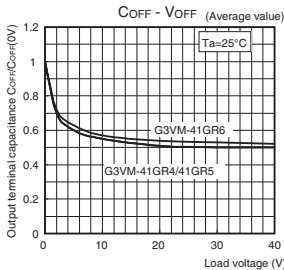

G3VM-81GR/81GR1

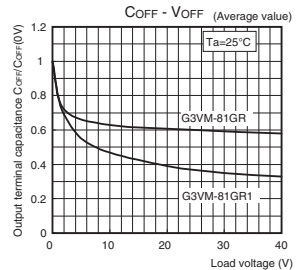

G3VM-21GR□/41GR4/41GR5/41GR6/81GR□ MOS FET Relays

■ Appearance / Terminal Arrangement / Internal Connections

● Appearance

SOP (Small Outline Package)

SOP 4-pin

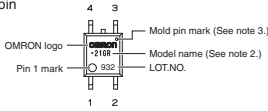

Note 1: The actual product is marked differently from the image shown here.

Note 2: "G3VM" does not appear in the model number on the Relay.

Note 3: The indentation in the corner diagonally opposite from the pin 1 mark is from a pin on the mold.

● Terminal Arrangement/Internal Connections (Top View)

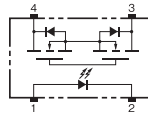

■ Dimensions (Unit: mm)



Surface-mounting Terminals

Weight: 0.1 g

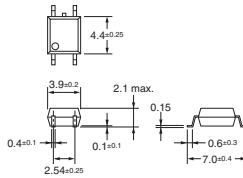

Actual Mounting Pad Dimensions (Recommended Value, TOP VIEW)

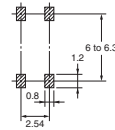

Note: The actual product is marked differently from the image shown here.

■ Approved Standards

UL recognized 

Approved Standards	Contact form	File No.
UL (recognized)	1a (SPST-NO)	E80555

■ Safety Precautions

- Refer to the *Common Precautions for All MOS FET Relays* for precautions that apply to all MOS FET Relays.

G3VM-21LR

MOS FET Relays SSOP, Low-output-capacitance and Low-ON-resistance Type (with Low C × R)

MOS FET Relays in SSOP packages that achieve a low C × R

- Load voltage: 20 V
- G3VM-21LR: Low C × R = 5 pF·Ω, C_{OFF} (standard) = 1 pF, R_{ON} (standard) = 5 Ω
- G3VM-21LR10: Low C × R = 2.4 pF·Ω, C_{OFF} (standard) = 0.8 pF, R_{ON} (standard) = 3 Ω
- G3VM-21LR1: Low C × R = 4 pF·Ω, C_{OFF} (standard) = 5 pF, R_{ON} (standard) = 0.8 Ω
- G3VM-21LR11: Low C × R = 7.2 pF·Ω, C_{OFF} (standard) = 40 pF, R_{ON} (standard) = 0.18 Ω

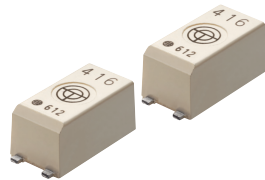

Note: The actual product is marked differently from the image shown here.

RoHS Compliant

Application Examples

- Semiconductor test equipment
- Communication equipment
- Test & Measurement equipment
- Data loggers

Package

(Unit : mm, Average)

SSOP 4-pin

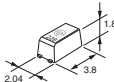

Note: The actual product is marked differently from the image shown here.

Model Number Legend

G3VM-□□□□□
1 2 3 4 5

- Load Voltage**
2 : 20 V
- Contact form**
1 : 1a (SPST-NO) L : SSOP 4-pin
- Package**
- Additional functions**
R : Low ON resistance
- Other informations**
When specifications overlap, serial code is added in the recorded order.

Ordering Information

Package	Contact form	Terminals	Load voltage (peak value) *	Continuous load current (peak value) *	Tape cut packaging		Tape packaging	
					Model	Minimum package quantity	Model	Minimum package quantity
SSOP4	1a (SPST-NO)	Surface-mounting Terminals	20 V	160 mA	G3VM-21LR	1 pc.	G3VM-21LR(TR05)	500 pcs.
				200 mA	G3VM-21LR10		G3VM-21LR10(TR05)	
				450 mA	G3VM-21LR1		G3VM-21LR1(TR05)	
				900 mA	G3VM-21LR11		G3VM-21LR11(TR05)	

* The AC peak and DC value are given for the load voltage and continuous load current.

Note: To order tape packaging for Relays with surface-mounting terminals, add "(TR05)" to the end of the model number.

Tape-cut SSOPs are packaged without humidity resistance. Use manual soldering to mount them. Refer to common precautions.

Absolute Maximum Ratings (T_a = 25°C)

Item	Symbol	G3VM-21LR	G3VM-21LR10	G3VM-21LR1	G3VM-21LR11	Unit	Measurement conditions
LED forward current	I _F	50	30	50	50	mA	
LED forward current reduction rate	ΔI _F /°C	-0.5	-0.3		-0.5	mA/°C	T _a ≥ 25°C
LED reverse voltage	V _R			5		V	
Connection temperature	T _J			125		°C	
Load voltage (AC peak/DC)	V _{OFF}			20		V	
Continuous load current (AC peak/DC)	I _O	160	200	450	900	mA	
ON current reduction rate	ΔI _O /°C	-1.6	-2.0	-4.5	-12	mA/°C	G3VM-21LR11 : T _a ≥ 50°C Others : T _a ≥ 25°C
Pulse ON current	I _{OP}	480	600	1,350	2,700	mA	t _s = 100 ms, Duty = 1/10
Connection temperature	T _J			125		°C	
Dielectric strength between I/O *	V _{I-O}			1500		V _{RMS}	AC for 1 min
Ambient operating temperature	T _a			-20 to +85		°C	With no icing or condensation
Ambient storage temperature	T _{stg}			-40 to +125		°C	
Soldering temperature	-			260		°C	10 s

* The dielectric strength between the input and output was checked by applying voltage between all pins as a group on the LED side and all pins as a group on the light-receiving side.

■Electrical Characteristics (Ta = 25°C)

Item		Symbol	G3VM-21LR	G3VM-21LR10	G3VM-21LR1	G3VM-21LR11	Unit	Measurement conditions	
Input	LED forward voltage	V _F	Minimum	1.0	1.15	1.0		V	G3VM-21LR10 : I _F =5 mA G3VM-21LR/21LR1/21LR11 : I _F =10 mA
			Typical	1.15	1.35	1.15			
			Maximum	1.3	1.45	1.3			
	Reverse current	I _R	Maximum	10				μA	V _R =5 V
	Capacitance between terminals	C _T	Typical	15	70	15		pF	V=0, f=1 MHz
Output	Trigger LED forward current	I _{FT}	Maximum	4	3	4	3	mA	I _O =100 mA
	Release LED forward current	I _{FC}	Minimum	0.2	0.1	0.2	0.1	mA	I _{OFF} =10 μA
	Maximum resistance with output ON	R _{ON}	Typical	5	3	0.8	0.18	Ω	G3VM-21LR/21LR1 : I _F =5 mA, I _O =Continuous load current ratings, t _F =10 ms G3VM-21LR10/21LR11 : I _F =5 mA, I _O =Continuous load current ratings, t _F <1 s
			Maximum	8	5	1.2	0.22		
	Current leakage when the relay is open	I _{LEAK}	Typical	-				nA	G3VM-21LR/21LR1: V _{OFF} =20 V, Ta=50°C G3VM-21LR10/21LR11 : V _{OFF} =20 V
			Maximum	1	0.2	1			
	Capacitance between terminals	C _{OFF}	Typical	1	0.8	5	40	pF	G3VM-21LR10 : V=0, f=100 MHz G3VM-21LR/21LR1/21LR11 : V=0, f=100 MHz, t<1 s
Maximum			2.5	1.1	12	-			
Capacitance between I/O terminals	C _{I-O}	Typical	0.8	0.3	0.8	0.3	pF	f=1 MHz, V _S =0 V	
Insulation resistance between I/O terminals	R _{I-O}	Minimum	1000				MΩ	V _{I-O} =500 VDC, RoHS60%	
		Typical	10 ⁸						
Turn-ON time	t _{ON}	Typical	0.06	-	0.2	0.3	ms	I _F =5 mA, R _L =200 Ω, V _{DD} =10 V *	
		Maximum	0.5	0.2	0.5	2			
Turn-OFF time	t _{OFF}	Typical	0.12	-	0.2				
		Maximum	0.5	0.2	0.5	1			

* Turn-ON and Turn-OFF Times

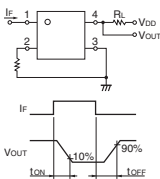

■Recommended Operating Conditions

For usage with high reliability, Recommended Operation Conditions is a measure that takes into account the derating of Absolute Maximum Ratings and Electrical Characteristics.

Each item on this list is an independent condition, so it is not simultaneously satisfy several conditions.

Item	Symbol		G3VM-21LR	G3VM-21LR10	G3VM-21LR1	G3VM-21LR11	Unit
Load voltage (AC peak/DC)	V _{DD}	Maximum	20				V
		Minimum	10	-	10	-	
Operating LED forward current	I _F	Maximum	30	20	30	20	mA
		Maximum	160	200	450	900	
Ambient operating temperature	Ta	Minimum	-20				°C
		Maximum	60				

■Spacing and Insulation

Item	Minimum	Unit
Creepage distances	2.5	mm
Clearance distances	2.5	
Internal isolation thickness	0.1	

G3VM-21LR□

MOS FET Relays

■ Engineering Data

● LED forward current vs. Ambient temperature

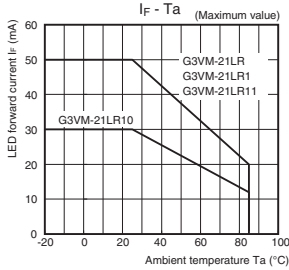

● Continuous load current vs. On-state voltage

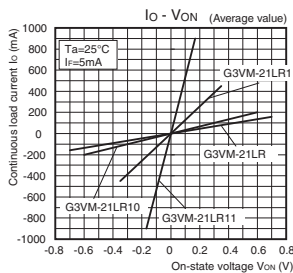

● Trigger LED forward current vs. Ambient temperature

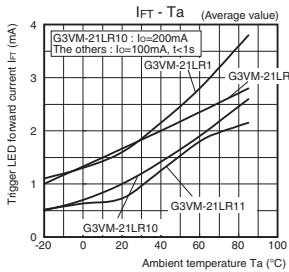

● Continuous load current vs. Ambient temperature

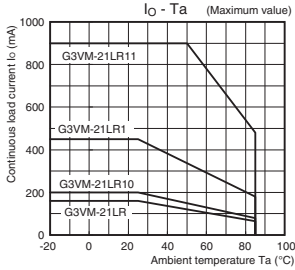
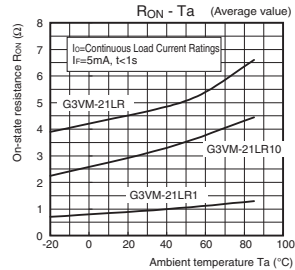
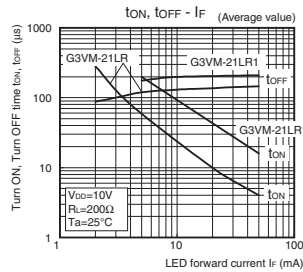
● On-state resistance vs. Ambient temperature
G3VM-21LR/21LR10/21LR1● Turn ON, Turn OFF time vs. LED forward current
G3VM-21LR/21LR1

● LED forward current vs. LED forward voltage

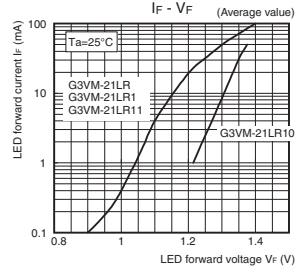

G3VM-21LR11

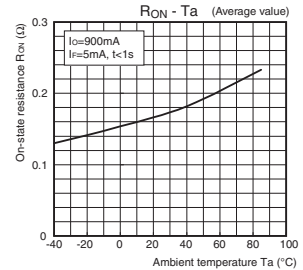

G3VM-21LR10/21LR1

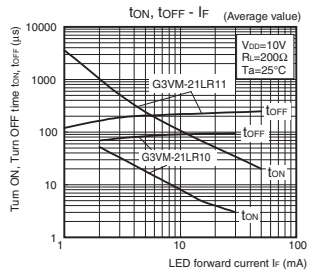

Engineering Data

Turn ON, Turn OFF time vs. Ambient temperature G3VM-21LR/21LR1

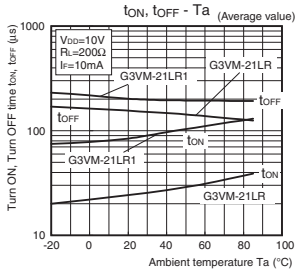

Current leakage vs. Load voltage G3VM-21LR/21LR1

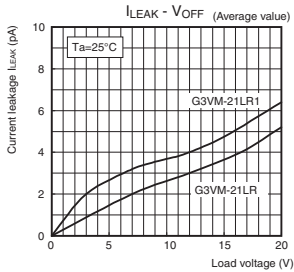

G3VM-21LR10/21LR11

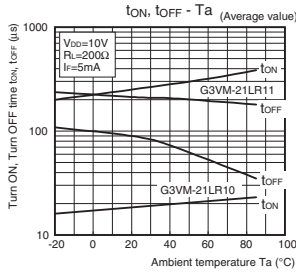

G3VM-21LR11

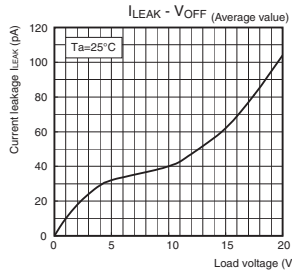

Current leakage vs. Ambient temperature G3VM-21LR10

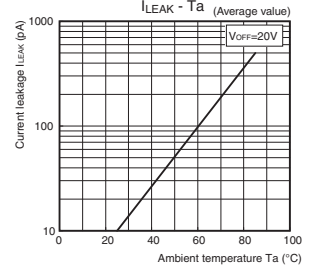

Output terminal capacitance vs. Load voltage G3VM-21LR/21LR1/21LR11

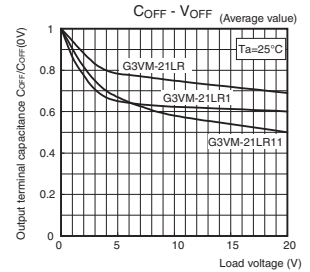

G3VM-21LR□

MOS FET Relays

■ Appearance / Terminal Arrangement / Internal Connections

● Appearance

SSOP (Shrink Small Outline Package)
SSOP 4-pin

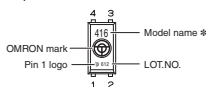

Note: 1. The actual product is marked differently from the image shown here.

Note: 2. "G3VM" does not appear in the model number on the Relay.

* Actual model name marking for each model

Model	Marking
G3VM-21LR	210
G3VM-21LR10	21A
G3VM-21LR11	211
G3VM-21LR11	21B

● Terminal Arrangement/ Internal Connections (Top View)

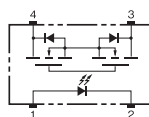

■ Dimensions (Unit: mm)



Surface-mounting Terminals

Weight: 0.03 g

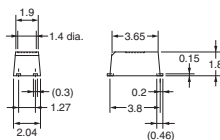

Unless otherwise specified, the dimensional tolerance is ± 0.1 mm.

Actual Mounting Pad Dimensions

(Recommended Value, TOP VIEW)

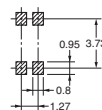

Note: The actual product is marked differently from the image shown here.

■ Approved Standards

UL recognized 

Approved Standards	Contact form	File No.
UL (recognized)	1a (SPST-NO)	E80555

■ Safety Precautions

- Refer to the *Common Precautions for All MOS FET Relays* for precautions that apply to all MOS FET Relays.

G3VM-41LR

MOS FET Relays SSOP, Low-output-capacitance and Low-ON-resistance Type (with Low C × R)

MOS FET Relays in SSOP packages that achieve a low C × R

- Load voltage : 40 V
- G3VM-41LR10 : Low C × R = 5.4 pF·Ω, C_{OFF} (standard) = 0.45 pF, R_{ON} (standard) = 12 Ω
- G3VM-41LR6 : Low C × R = 10 pF·Ω, C_{OFF} (standard) = 1 pF, R_{ON} (standard) = 10 Ω
- G3VM-41LR11 : Low C × R = 4.9 pF·Ω, C_{OFF} (standard) = 0.7 pF, R_{ON} (standard) = 7 Ω
- G3VM-41LR4 : Low C × R = 10 pF·Ω, C_{OFF} (standard) = 5 pF, R_{ON} (standard) = 2 Ω
- G3VM-41LR5 : Low C × R = 10 pF·Ω, C_{OFF} (standard) = 10 pF, R_{ON} (standard) = 1 Ω



Note: The actual product is marked differently from the image shown here.

RoHS Compliant

Application Examples

- Semiconductor test equipment
- Communication equipment
- Test & Measurement equipment
- Data loggers

Package

(Unit : mm, Average)

SSOP 4-pin

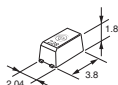

Note: The actual product is marked differently from the image shown here.

Model Number Legend

G3VM-□□□□□
1 2 3 4 5

1. Load Voltage 2. Contact form 3. Package
4 : 40 V 1 : 1a (SPST-NO) L : SSOP 4-pin

4. Additional functions 5. Other informations

R: Low ON resistance

When specifications overlap, serial code is added in the recorded order.

Ordering Information

Package	Contact form	Terminals	Load voltage (peak value) *	Continuous load current (peak value) *	Tape cut packaging		Tape packaging	
					Model	Minimum package quantity	Model	Minimum package quantity
SSOP4	1a (SPST-NO)	Surface-mounting Terminals	40 V	120 mA	G3VM-41LR10	1 pc.	G3VM-41LR10(TR05)	500 pcs.
				140 mA	G3VM-41LR6		G3VM-41LR6(TR05)	
				250 mA	G3VM-41LR11		G3VM-41LR11(TR05)	
				300 mA	G3VM-41LR4		G3VM-41LR4(TR05)	
					G3VM-41LR5		G3VM-41LR5(TR05)	

* The AC peak and DC value are given for the load voltage and continuous load current.

Note: To order tape packaging for Relays with surface-mounting terminals, add "(TR05)" to the end of the model number.

Tape-cut SSOPs are packaged without humidity resistance. Use manual soldering to mount them. Refer to common precautions.

Absolute Maximum Ratings (Ta = 25°C)

Item	Symbol	G3VM-41LR10	G3VM-41LR6	G3VM-41LR11	G3VM-41LR4	G3VM-41LR5	Unit	Measurement conditions	
Input	LED forward current	If	30	50	30	50	mA		
	LED forward current reduction rate	ΔI _F /°C	-0.3	-0.5	-0.3	-0.5	mA/°C	Ta ≥ 25°C	
	LED reverse voltage	V _R			5		V		
Output	Connection temperature	T _J			125		°C		
	Load voltage (AC peak/DC)	V _{OFF}			40		V		
	Continuous load current (AC peak/DC)	I _O	120		140	250	300	mA	
	ON current reduction rate	ΔI _O /°C	-1.2		-1.4	-2.5	-3.0	mA/°C	Ta ≥ 25°C
	Pulse ON current	I _{OP}	360		420	750	900	mA	t=100 ms, Duty=1/10
	Connection temperature	T _J			125			°C	
	Dielectric strength between I/O *	V _{I/O}			1500			Vrms	AC for 1 min
	Ambient operating temperature	T _a			-20 to +85			°C	With no icing or condensation
	Ambient storage temperature	T _{stg}			-40 to +125			°C	
Soldering temperature	-			260			°C	10 s	

* The dielectric strength between the input and output was checked by applying voltage between all pins as a group on the LED side and all pins as a group on the light-receiving side.

Introduction
General purpose
High-speed voltage
Multi-contact pair
High-current and
High-ON-resistance
Small and high-
High-dielectric-
High-dielectric-
Current-limiting
Low-voltage-specification
Small and High-
Certified Models with
Standards Derivation

G3VM-41LR□

G3VM-41LR□

MOS FET Relays

■Electrical Characteristics (Ta = 25°C)

Item	Symbol		G3VM-41LR10	G3VM-41LR6	G3VM-41LR11	G3VM-41LR4	G3VM-41LR5	Unit	Measurement conditions
LED forward voltage	V _F	Minimum	1.15	1.0	1.15	1.0		V	G3VM-41LR4/41LR5/41LR6 : I _F =10 mA G3VM-41LR10/41LR11 : I _F =5 mA
		Typical	1.35	1.15	1.3	1.15			
		Maximum	1.45	1.3	1.45	1.3			
		Reverse current	I _r	Maximum					
Capacitance between terminals	C _T	Typical	70	15	70	15		pF	V=0, f=1 MHz
Trigger LED forward current	I _{FT}	Maximum	3	4	3	4		mA	I _o =100 mA
Release LED forward current	I _{FC}	Minimum	0.1	0.2	0.1	0.2		mA	G3VM-41LR4/41LR5/41LR6/41LR10 : I _{oFF} =10 μA G3VM-41LR11 : I _{oFF} =1 μA
Maximum resistance with output ON	R _{ON}	Typical	12	10	7	2	1	Ω	G3VM-41LR4/41LR6 : I _F =5 mA, I _o =Continuous load current ratings, t=10 ms G3VM-41LR5/41LR10/41LR11 : I _F =5 mA, I _o =Continuous load current ratings, t<1 s
		Maximum	14	15	10	3	1.5		
Current leakage when the relay is open	I _{LEAK}	Typical	0.01	–	0.01	–		nA	G3VM-41LR4/41LR5/41LR6: V _{OFF} =30 V, Ta=50°C G3VM-41LR10/41LR11 : V _{OFF} =35 V
		Maximum	0.2	1	0.2	1			
Capacitance between terminals	C _{OFF}	Typical	0.45	1	0.7	5	10	pF	V=0, f=100 MHz, t<1 s
		Maximum	0.8	2	1.3	7	14		
Capacitance between I/O terminals	C _{I-O}	Typical	0.3	0.8	0.3	0.8		pF	f=1 MHz, V _s =0 V
Insulation resistance between I/O terminals	R _{I-O}	Minimum	1000					MΩ	V _{I-O} =500 VDC, R _{oH} ±60%
		Typical	10 ⁸						
Turn-ON time	t _{ON}	Typical	–	0.05	–	0.12	0.2	ms	I _F =5 mA, R _L =200 Ω, V _{DD} =10 V *
		Maximum	0.2	0.5	0.2	0.5			
Turn-OFF time	t _{OFF}	Typical	–	0.12	–	0.14	0.2	ms	I _F =5 mA, R _L =200 Ω, V _{DD} =10 V *
		Maximum	0.3	0.5	0.2	0.5			

* Turn-ON and Turn-OFF Times

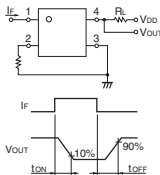

■Recommended Operating Conditions

For usage with high reliability, Recommended Operation Conditions is a measure that takes into account the derating of Absolute Maximum Ratings and Electrical Characteristics.

Each item on this list is an independent condition, so it is not simultaneously satisfy several conditions.

Item	Symbol		G3VM-41LR10	G3VM-41LR6	G3VM-41LR11	G3VM-41LR4	G3VM-41LR5	Unit	
Load voltage (AC peak/DC)	V _{DD}	Maximum	32						V
		Minimum	–	10	–	10			
Operating LED forward current	I _F	Minimum	20	30	20	30		mA	
		Maximum	120		140	250	300		
Continuous load current (AC peak/DC)	I _o	Maximum	120		140	250	300		
Ambient operating temperature	Ta	Minimum	-20					°C	
		Maximum	60						

■Spacing and Insulation

Item	Minimum	Unit
Creepage distances	2.5	mm
Clearance distances	2.5	
Internal isolation thickness	0.1	

G3VM-41LR□

MOS FET Relays

Engineering Data

LED forward current vs. Ambient temperature

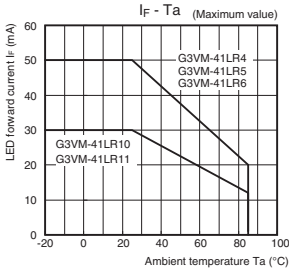

Continuous load current vs. On-state voltage

G3VM-41LR6/41LR4/41LR5

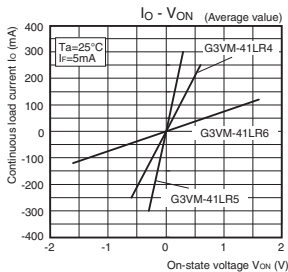

Trigger LED forward current vs. Ambient temperature

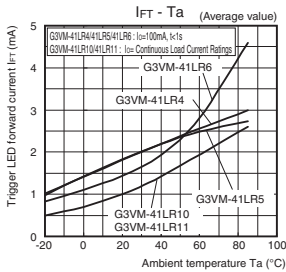

Continuous load current vs. Ambient temperature

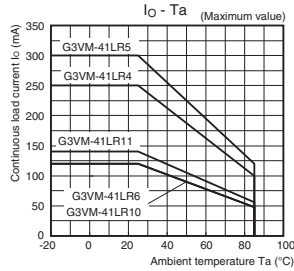

G3VM-41LR10/41LR11

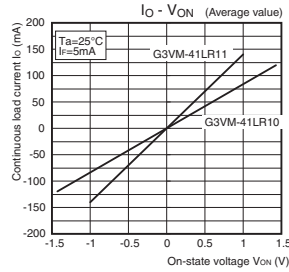

Turn ON, Turn OFF time vs. LED forward current

G3VM-41LR6/41LR4/41LR5

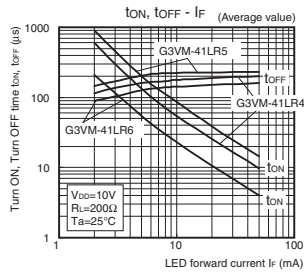

LED forward current vs. LED forward voltage

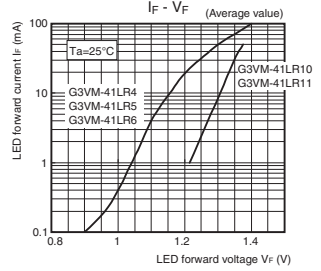

On-state resistance vs. Ambient temperature

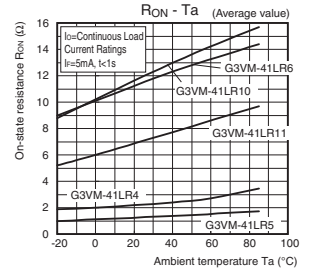

G3VM-41LR10/41LR11

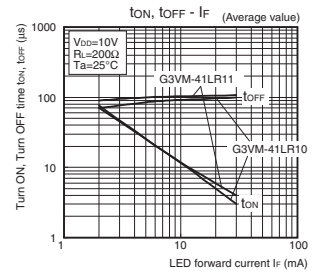

Introduction
General purpose
High-side voltage
Multi-contact pair (2a, 2b, and 1a1b)
High-current and Low-On-resistance
Small and high inductive strength
High-dielectric strength
Current-limiting
Low-voltage resistance
Small and High-side voltage
Certified Models with Standards Certification
DIP
SOP
SSOP
USOP
VSON
S-VSON
G3VM-41LR□

G3VM-41LR□

MOS FET Relays

Engineering Data

Turn ON, Turn OFF time vs. Ambient temperature G3VM-41LR6/41LR4/41LR5

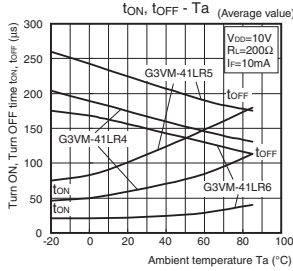

Current leakage vs. Load voltage G3VM-41LR6/41LR4/41LR5

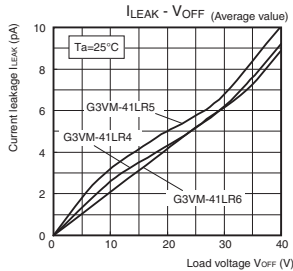

G3VM-41LR10/41LR11

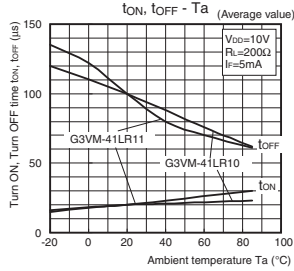

Output terminal capacitance vs. Load voltage G3VM-41LR6/41LR4/41LR5

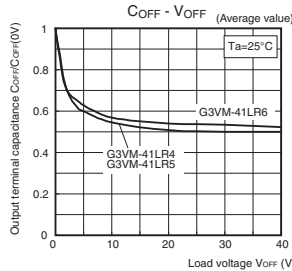

Current leakage vs. Ambient temperature G3VM-41LR10/41LR11

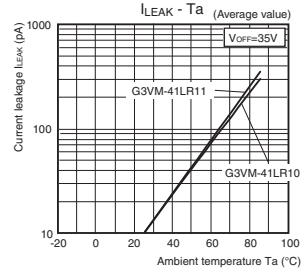

G3VM-41LR□

MOS FET Relays

■ Appearance / Terminal Arrangement / Internal Connections

● Appearance

SSOP (Shrink Small Outline Package)

SSOP 4-pin

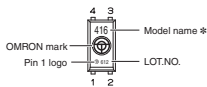

Note: 1. The actual product is marked differently from the image shown here.

Note: 2. "G3VM" does not appear in the model number on the Relay.

* Actual model name marking for each model

Model	Marking
G3VM-41LR10	41A
G3VM-41LR6	41B
G3VM-41LR11	41B
G3VM-41LR4	41A
G3VM-41LR5	41S

● Terminal Arrangement/ Internal Connections (Top View)

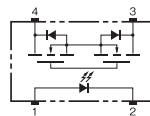

■ Dimensions (Unit: mm)



Surface-mounting Terminals

Weight: 0.03 g

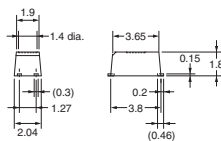

Actual Mounting Pad Dimensions (Recommended Value, TOP VIEW)

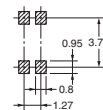

Note: The actual product is marked differently from the image shown here.

■ Approved Standards

UL recognized 

Approved Standards	Contact form	File No.
UL (recognized)	1a (SPST-NO)	E80555

■ Safety Precautions

- Refer to the *Common Precautions for All MOS FET Relays* for precautions that apply to all MOS FET Relays.

G3VM-21PR

MOS FET Relays USOP, Low-output-capacitance and Low-ON-resistance Type (with Low $C \times R$)

USOP Package with Low Output Capacitance and ON Resistance

- Load voltage: 20 V
- G3VM-21PR10: Low $C \times R = 2.4 \text{ pF} \cdot \Omega$, C_{OFF} (standard) = 0.8 pF, R_{ON} (standard) = 3 Ω
- G3VM-21PR1: Low $C \times R = 3 \text{ pF} \cdot \Omega$, C_{OFF} (standard) = 5 pF, R_{ON} (standard) = 0.6 Ω
- G3VM-21PR11: Low $C \times R = 7.2 \text{ pF} \cdot \Omega$, C_{OFF} (standard) = 40 pF, R_{ON} (standard) = 0.18 Ω

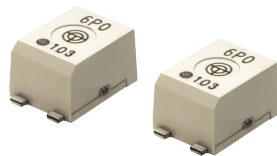

Note: The actual product is marked differently from the image shown here.

RoHS Compliant

Application Examples

- Semiconductor test equipment
- Communication equipment
- Test & measurement equipment
- Data loggers

Package (Unit : mm, Average)

USOP 4-pin

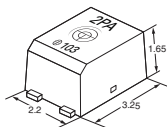

Note: The actual product is marked differently from the image shown here.

Model Number Legend

G3VM-□□□□□
1 2 3 4 5

1. Load Voltage

2: 20 V

4. Additional functions

R: Low On-resistance

2. Contact form

1: 1a (SPST-NO)

5. Other informations

When specifications overlap, serial code is added in the recorded order.

3. Package

P: USOP 4 pin

Ordering Information

Package	Contact form	Terminals	Load voltage (peak value) *	Continuous load current (peak value) *	Tape cut packaging		Tape packaging	
					Model	Minimum package quantity	Model	Minimum package quantity
USOP4	1a (SPST-NO)	Surface-mounting Terminals	20 V	200 mA	G3VM-21PR10	1 pc.	G3VM-21PR10(TR05)	500 pcs.
				450 mA	G3VM-21PR1		G3VM-21PR1(TR05)	
				900 mA	G3VM-21PR11		G3VM-21PR11(TR05)	

Note: To order tape packaging for Relays with surface-mounting terminals, add "(TR05)" to the end of the model number.

Tape-cut USOPs are packaged without humidity resistance. Use manual soldering to mount them.

Refer to common precautions.

* The AC peak and DC value are given for the load voltage and continuous load current.

■Absolute Maximum Ratings (Ta = 25°C)

Item		Symbol	G3VM-21PR10	G3VM-21PR1	G3VM-21PR11	Unit	Measurement conditions
Input	LED forward current	IF	50			mA	
	LED forward current reduction rate	$\Delta I_F/\text{°C}$	-0.5			mA/°C	Ta≥25°C
	LED reverse voltage	VR	5			V	
Connection temperature		TJ	125			°C	
Output	Load voltage (AC peak/DC)	V _{OFF}	20			V	
	Continuous load current (AC peak/DC)	Io	200	450	900	mA	
	ON current reduction rate	$\Delta I_o/\text{°C}$	-2.0	-4.5	-12	mA/°C	G3VM-21PR10/21PR1 : Ta ≥ 25°C G3VM-21PR11 : Ta ≥ 50°C
	Pulse ON current	I _{op}	600	1,300	2,700	mA	I _o =100 ms, Duty=1/10
	Connection temperature	TJ	125			°C	
	Dielectric strength between I/O *	V _{i-o}	500			V _{rms}	AC for 1 min
Ambient operating temperature		Ta	-40 to +85			°C	
Ambient storage temperature		T _{stg}	-40 to +125			°C	With no icing or condensation
Soldering temperature		-	260			°C	10 s

* The dielectric strength between the input and output was checked by applying voltage between all pins as a group on the LED side and all pins as a group on the light-receiving side.

■Electrical Characteristics (Ta = 25°C)

Item		Symbol	G3VM-21PR10	G3VM-21PR1	G3VM-21PR11	Unit	Measurement conditions
Input	LED forward voltage	Minimum	1.0			V	I _F =10 mA
		Typical	1.15				
		Maximum	1.3				
	Reverse current	I _R	10			μA	V _R =5 V
Capacitance between terminals	C _T	15			pF	V=0, f=1 MHz	
Trigger LED forward current	I _{FT}	Typical	0.6			mA	I _o =100 mA
		Maximum	3				
Release LED forward current	I _{FC}	0.1			mA	I _{OFF} =10 μA	
Maximum resistance with output ON	R _{ON}	Typical	3	0.6	0.18	Ω	I _F =5 mA, t<1 s I _o =Continuous load current ratings
		Maximum	5	1.2	0.22		
Current leakage when the relay is open	I _{LEAK}	1			nA	V _{OFF} =20 V	
Capacitance between terminals	C _{OFF}	Typical	5			pF	V=0, f=100 MHz, t<1 s
		Maximum	1.1	12	-		
Capacitance between I/O terminals	C _{i-o}	0.4			pF	f=1 MHz, V _S =0 V	
Insulation resistance between I/O terminals	R _{i-o}	Minimum	1000			MΩ	V _{i-o} =500VDC, RoH≤60%
		Typical	10 ⁶				
Turn-ON time	t _{ON}	Typical	0.04	0.2	0.5	ms	I _F =5 mA, R _L =200 Ω, V _{DD} =10 V *1
		Maximum	0.2	0.5	2		
Turn-OFF time	t _{OFF}	Typical	0.13	0.2	0.1	ms	I _F =5 mA, V _{DD} =0.25 V, T _r (in)=25 ps *2
		Maximum	0.2	0.5	1		
Equivalent rise time	ERT	Typical	-	40	-	ps	I _F =5 mA, V _{DD} =0.25 V, T _r (in)=25 ps *2
		Maximum	-	90	-		

*1. Turn-ON and Turn-OFF Times

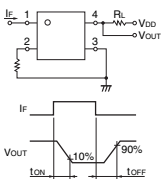

*2. Equivalent Rise Time

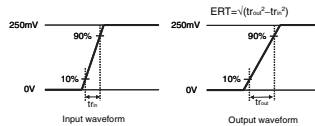

■Recommended Operating Conditions

For usage with high reliability, Recommended Operation Conditions is a measure that takes into account the derating of Absolute Maximum Ratings and Electrical Characteristics.

Each item on this list is an independent condition, so it is not simultaneously satisfy several conditions.

Item	Symbol	G3VM-21PR10	G3VM-21PR1	G3VM-21PR11	Unit
Load voltage (AC peak/DC)	V _{DD}	Maximum	16		V
		Minimum	5		
Operating LED forward current	I _F	Typical	7.5		mA
		Maximum	20		
		Continuous load current (AC peak/DC)	Io	200	
Ambient operating temperature	Ta	Minimum	-20		°C
		Maximum	65		

G3VM-21PR□

MOS FET Relays

Engineering Data

LED forward current vs. Ambient temperature

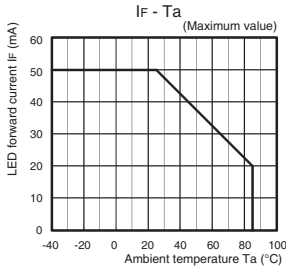

Continuous load current vs. Ambient temperature

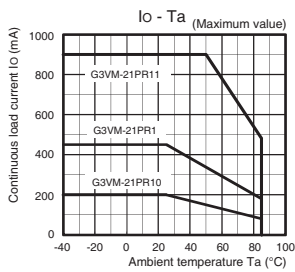

LED forward current vs. LED forward voltage

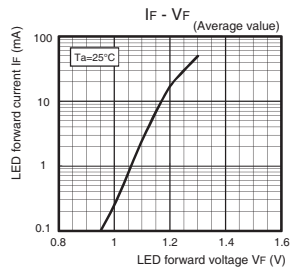

Continuous load current vs. On-state voltage

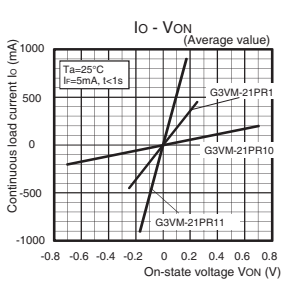

On-state resistance vs. Ambient temperature

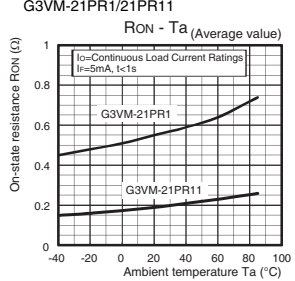

G3VM-21PR10

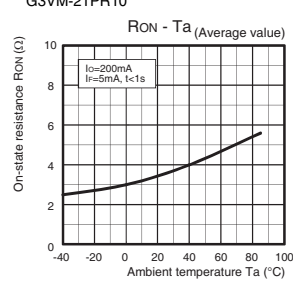

Trigger LED forward current vs. Ambient temperature

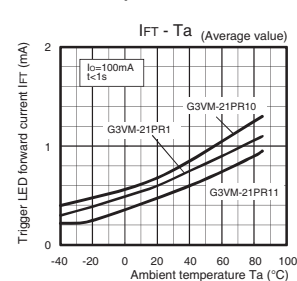

Turn ON, Turn OFF time vs. LED forward current

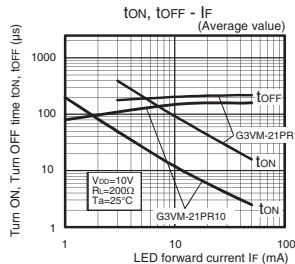

G3VM-21PR11

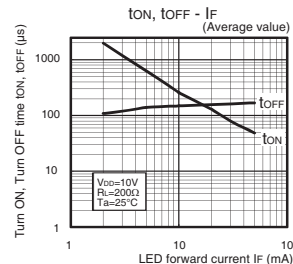

Introduction
General-purpose
High-load-voltage
Multi-load-voltage (2A, 2A, and 1A)
High-current and Low-on-resistance
Small and light
High-dielectric strength
High-dielectric strength
Current-limiting
Transient capacitance and low-on-resistance
Small and High-load-voltage
Scientific notation
DIP
SOP
SSOP
USOP
VSON
S-VSON
G3VM-21PR□

Engineering Data

Turn ON, Turn OFF time vs. Ambient temperature G3VM-21PR10/21PR1

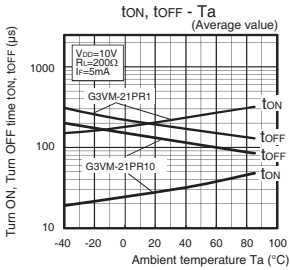

G3VM-21PR11

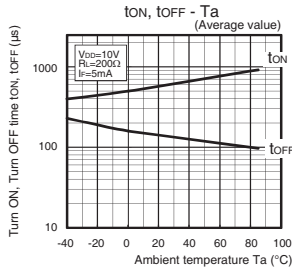

Current leakage vs. Load voltage

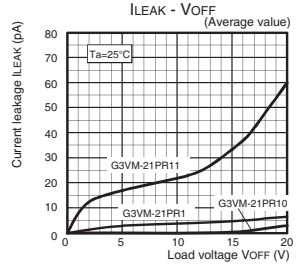

Output terminal capacitance vs. Load voltage

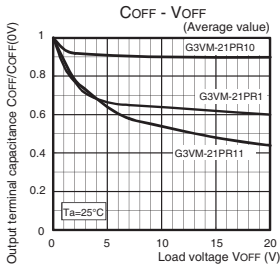

G3VM-21PR□

MOS FET Relays

■ Appearance / Terminal Arrangement / Internal Connections

● Appearance

USOP (Ultra Small Outline Package)

USOP 4-pin

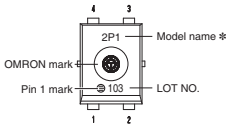

* Actual model name marking for each model

Model	Marking
G3VM-21PR10	2PA
G3VM-21PR1	2P1
G3VM-21PR11	2PB

Note: 1. The actual product is marked differently from the image shown here.

Note: 2. "G3VM" does not appear in the model number on the Relay.

● Terminal Arrangement/Internal Connections (Top View)

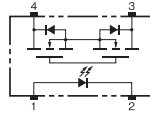

■ Dimensions (Unit: mm)

Surface-mounting Terminals

Weight: 0.03 g

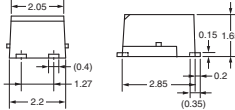
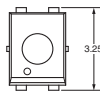
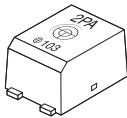

Unless otherwise specified, the dimensional tolerance is ± 0.2 mm.

Actual Mounting Pad Dimensions

(Recommended Value, Top View)

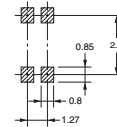

Unless otherwise specified, the dimensional tolerance is ± 0.2 mm.

Note: The actual product is marked differently from the image shown here.

■ Approved Standards

UL recognized 

Approved Standards	Contact form	File No.
UL recognized	1a (SPST-NO)	E80555

■ Safety Precautions

- Refer to the *Common Precautions for All MOS FET Relays* for precautions that apply to all MOS FET Relays.

G3VM-41PR□/51PR

MOS FET Relays USOP, Low-output-capacitance and Low-ON-resistance Type (with Low C × R)

USOP Package with Low Output Capacitance and ON Resistance

- Load voltage: 40 V or 50 V
- G3VM-41PR12: Low C × R = 4.5 pF·Ω, C_{OFF} (standard) = 0.3 pF, R_{ON} (standard) = 15 Ω
- G3VM-41PR6: Low C × R = 10 pF·Ω, C_{OFF} (standard) = 1 pF, R_{ON} (standard) = 10 Ω
- G3VM-41PR10: Low C × R = 5.4 pF·Ω, C_{OFF} (standard) = 0.45 pF, R_{ON} (standard) = 12 Ω
- G3VM-41PR11: Low C × R = 4.9 pF·Ω, C_{OFF} (standard) = 0.7 pF, R_{ON} (standard) = 7 Ω
- G3VM-41PR5: Low C × R = 10 pF·Ω, C_{OFF} (standard) = 10 pF, R_{ON} (standard) = 1 Ω
- G3VM-51PR: Low C × R = 12 pF·Ω, C_{OFF} (standard) = 12 pF, R_{ON} (standard) = 1 Ω



Note: The actual product is marked differently from the image shown here.

RoHS Compliant

Application Examples

- Semiconductor test equipment
- Communication equipment
- Test & measurement equipment
- Data loggers

Package (Unit : mm, Average)

USOP 4-pin

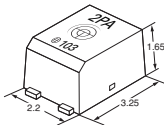

Note: The actual product is marked differently from the image shown here.

Model Number Legend

G3VM-□□□□□
1 2 3 4 5

1. Load Voltage

- 4: 40 V
- 5: 50 V

2. Contact form

- 1: 1a (SPST-NO)

3. Package

- P: USOP 4-pin

4. Additional functions

- R: Low On-resistance

5. Other informations

When specifications overlap, serial code is added in the recorded order.

Ordering Information

Package	Contact form	Terminals	Load voltage (peak value) *	Continuous load current (peak value) *	Tape cut packaging		Tape packaging	
					Model	Minimum package quantity	Model	Minimum package quantity
USOP4	1a (SPST-NO)	Surface-mounting Terminals	40 V	100 mA	G3VM-41PR12	1 pc.	G3VM-41PR12(TR05)	500 pcs.
				120 mA	G3VM-41PR6		G3VM-41PR6(TR05)	
				140 mA	G3VM-41PR10		G3VM-41PR10(TR05)	
				300 mA	G3VM-41PR11		G3VM-41PR11(TR05)	
				300 mA	G3VM-41PR5		G3VM-41PR5(TR05)	
50 V	300 mA	G3VM-51PR	G3VM-51PR(TR05)					

Note: To order tape packaging for Relays with surface-mounting terminals, add "(TR05)" to the end of the model number.

Tape-cut USOPs are packaged without humidity resistance. Use manual soldering to mount them.

Refer to common precautions.

* The AC peak and DC value are given for the load voltage and continuous load current.

RoHS

Introduction

General purpose

High-speed-voltage

Multi-contact pair

High-current and Low-ON-resistance

Small and high- dielectric-strength

High-dielectric-strength

Current-limiting

Low-output-capacitance and Low-ON-resistance

Small and High-speed-voltage

Certified Models with Standards Certification

DIP

SOP

SSOP

USOP

VSON

S-VSON

G3VM-41PR□/51PR

G3VM-41PR□/51PR

MOS FET Relays

■Absolute Maximum Ratings (Ta = 25°C)

Item	Symbol	G3VM-41PR12	G3VM-41PR6	G3VM-41PR10	G3VM-41PR11	G3VM-41PR5	G3VM-51PR	Unit	Measurement conditions	
Input	LED forward current	IF	50						mA	
	LED forward current reduction rate	$\Delta I/F^{\circ}C$	-0.5						$mA/^{\circ}C$	Ta \geq 25°C
	LED reverse voltage	VR	5						V	
Connection temperature		TJ	125						°C	
Load voltage (AC peak/DC)		Voff	40		50				V	
Output	Continuous load current (AC peak/DC)	Io	100	120	140	300		mA		
	ON current reduction rate	$\Delta I_o/^{\circ}C$	-1.0	-1.2	-1.4	-3		$mA/^{\circ}C$	Ta \geq 25°C	
	Pulse ON current	Iop	300	360	420	900		mA	t \leq 100 ms, Duty=1/10	
Connection temperature		TJ	125						°C	
Dielectric strength between I/O (See note 1.)		Vio	500						Vrms	AC for 1 min
Ambient operating temperature		Ta	-40 to +85						°C	
Ambient storage temperature		Tstg	-40 to +125						°C	With no icing or condensation
Soldering temperature		-	260						°C	10 s

Note: 1. The dielectric strength between the input and output was checked by applying voltage between all pins as a group on the LED side and all pins as a group on the light-receiving side.

■Electrical Characteristics (Ta = 25°C)

Item	Symbol		G3VM-41PR12	G3VM-41PR6	G3VM-41PR10	G3VM-41PR11	G3VM-41PR5	G3VM-51PR	Unit	Measurement conditions	
Input	LED forward voltage	VF	Minimum		1.0					V	If=10 mA
		Typical		1.15							
		Maximum		1.3							
Reverse current	IR	Maximum	10						μA	VR=5 V	
Capacitance between terminals	CT	Typical	15						pF	V=0, f=1 MHz	
Trigger LED forward current	IFT	Typical	1.0	0.6	0.5	1.0	0.6	0.5	mA	Io=100 mA	
		Maximum	3								
Release LED forward current	IFC	Minimum	0.1				0.2		mA	Ioff=10 μA	
Maximum resistance with output ON	ROn	Typical	15	10	12	7	1		Ω	If=5 mA, t<1 s Io=Continuous load current ratings	
		Maximum	20	15	14	10	1.5				
Current leakage when the relay is open	Ileak	Maximum	1	0.2	1					nA	Voff=Load voltage ratings
Capacitance between terminals	COFF	Typical	0.3	1	0.45	0.7	10	12	pF	V=0, f=100 MHz, t<1 s	
		Maximum	0.6	2	0.8	1.3	14	-			
Capacitance between I/O terminals	CI-O	Typical	0.4						pF	f=1 MHz, Vs=0 V	
Insulation resistance between I/O terminals	RI-O	Minimum	1000						M Ω	Vi-o=500 VDC, RoH \leq 60%	
		Typical	10 ⁸								
Turn-ON time	tON	Typical	0.04	0.05	0.03	0.04	0.2		ms	If=5 mA, RL=200 Ω , VDD=20 V *1	
		Maximum	0.2				0.5				
Turn-OFF time	tOFF	Typical	0.12	0.16	0.2	0.14	0.2	0.1	ms	If=5 mA, RL=200 Ω , VDD=20 V *1	
		Maximum	0.2	0.3		0.2	0.3	0.4			
Equivalent rise time	ERT	Typical	-				40		ps	If=5 mA, VDD=0.25 V, Tr(n)=25 ps *2	
		Maximum	-				90				

*1. Turn-ON and Turn-OFF Times

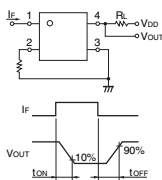

*2. Equivalent Rise Time

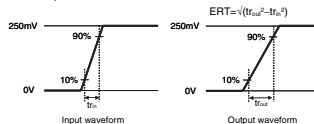

■Recommended Operating Conditions

For usage with high reliability, Recommended Operation Conditions is a measure that takes into account the derating of Absolute Maximum Ratings and Electrical Characteristics.

Each item on this list is an independent condition, so it is not simultaneously satisfy several conditions.

Item	Symbol		G3VM-41PR12	G3VM-41PR6	G3VM-41PR10	G3VM-41PR11	G3VM-41PR5	G3VM-51PR	Unit
Load voltage (AC peak/DC)	VDD	Maximum	32				40		V
		Minimum	5						
Operating LED forward current	IF	Typical	7.5						mA
		Maximum	20						
		Maximum	100	120		140	300		
Ambient operating temperature	Ta	Minimum	-20						°C
Maximum	65								

G3VM-41PR□/51PR

MOS FET Relays

Engineering Data

●LED forward current vs. Ambient temperature

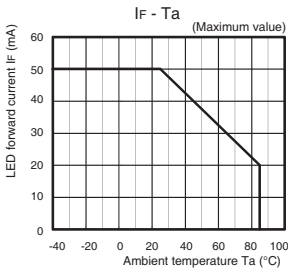

●Continuous load current vs. Ambient temperature

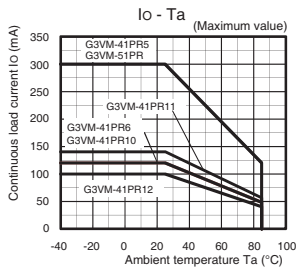

●LED forward current vs. LED forward voltage

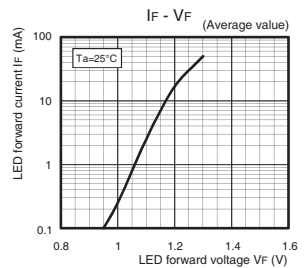

●Continuous load current vs. On-state voltage
G3VM-41PR6/41PR5

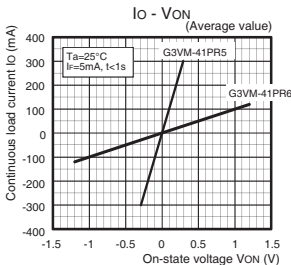

G3VM-41PR12/41PR10/41PR11/51PR

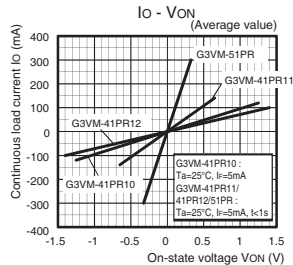

●On-state resistance vs. Ambient temperature

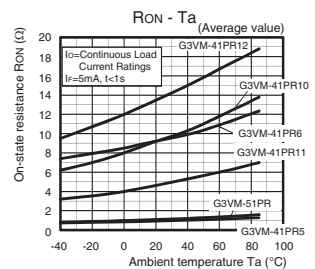

●Trigger LED forward current vs. Ambient temperature
G3VM-41PR6/41PR5

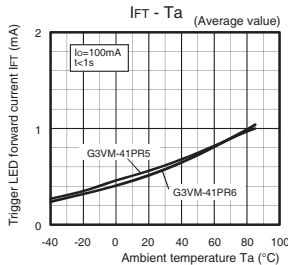

G3VM-41PR12/41PR10/41PR11/51PR

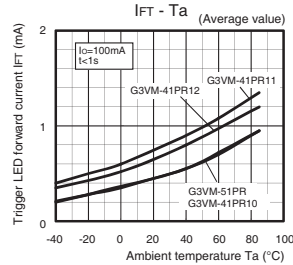

●Turn ON, Turn OFF time vs. LED forward current
G3VM-41PR6/41PR5

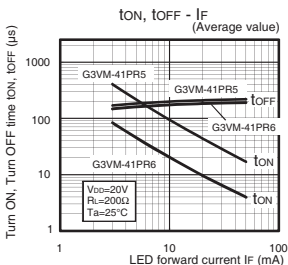

G3VM-41PR12/41PR10/41PR11

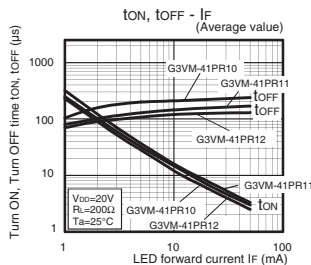

G3VM-51PR

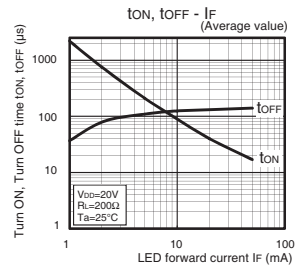

G3VM-41PR□/51PR

MOS FET Relays

Engineering Data

● **Turn ON, Turn OFF time vs. Ambient temperature**

G3VM-41PR6/41PR5

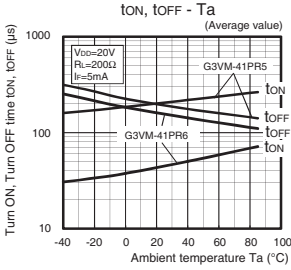

G3VM-41PR12/41PR10/41PR11

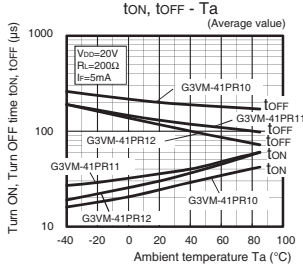

G3VM-51PR

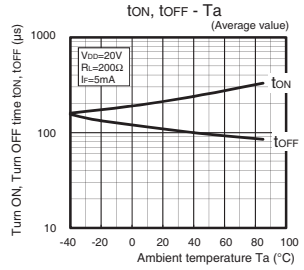

● **Output terminal capacitance vs. Load voltage**

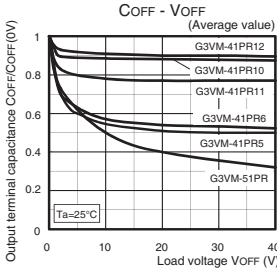

● **Current leakage vs. Load voltage**

G3VM-41PR6/41PR5

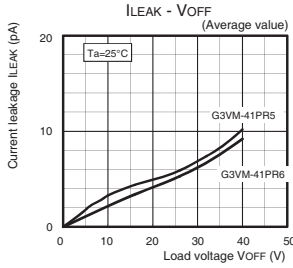

G3VM-41PR12/41PR10/41PR11/51PR

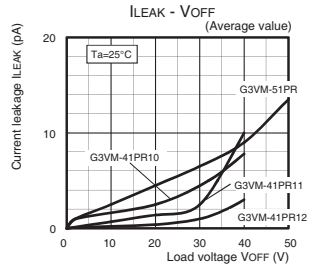

G3VM-41PR□/51PR

MOS FET Relays

■ Appearance / Terminal Arrangement / Internal Connections

● Appearance

USOP (Ultra Small Outline Package)

USOP 4-pin

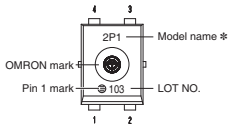

* Actual model name marking for each model

Model	Marking
G3VM-41PR12	4PC
G3VM-41PR6	4P6
G3VM-41PR10	4PA
G3VM-41PR11	4PB
G3VM-41PR5	4P5
G3VM-51PR	5P0

● Terminal Arrangement/Internal Connections (Top View)

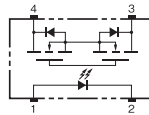
**Note:** 1. The actual product is marked differently from the image shown here.**Note:** 2. "G3VM" does not appear in the model number on the Relay.

■ Dimensions (Unit: mm)

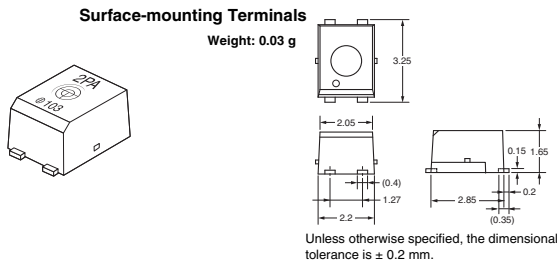

Actual Mounting Pad Dimensions

(Recommended Value, Top View)

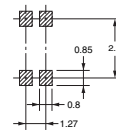
Unless otherwise specified, the dimensional tolerance is ± 0.2 mm.**Note:** The actual product is marked differently from the image shown here.

■ Approved Standards

UL recognized 

Approved Standards	Contact form	File No.
UL recognized	1a (SPST-NO)	E80555

■ Safety Precautions

- Refer to the *Common Precautions for All MOS FET Relays* for precautions that apply to all MOS FET Relays.

G3VM-21UR

MOS FET Relays VSON, Low-output-capacitance and Low-ON-resistance Type (with Low C × R)

World's smallest class New VSON Package with Low Output Capacitance and Low ON Resistance

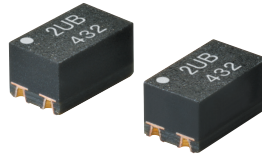

Note: The actual product is marked differently from the image shown here.

- Load voltage: 20 V
- G3VM-21UR10: Low $C \times R = 2.4 \text{ pF} \cdot \Omega$, C_{OFF} (standard) = 0.8 pF, R_{ON} (standard) = 3 Ω
- G3VM-21UR1: Low $C \times R = 4 \text{ pF} \cdot \Omega$, C_{OFF} (standard) = 5 pF, R_{ON} (standard) = 0.8 Ω
- G3VM-21UR11: Low $C \times R = 7.2 \text{ pF} \cdot \Omega$, C_{OFF} (standard) = 40 pF, R_{ON} (standard) = 0.18 Ω

RoHS Compliant

Application Examples

- Semiconductor test equipment
- Communication equipment
- Test & measurement equipment
- Data loggers

Package (Unit : mm, Average)

VSON 4-pin

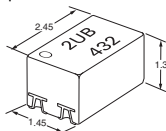

Note: The actual product is marked differently from the image shown here.

Model Number Legend

G3VM-

1	2	3	4	5

- Load Voltage**
2: 20 V
- Contact form**
1: 1a (SPST-NO)
- Package**
U: VSON 4-pin
- Additional functions**
R: Low On-resistance
- Other informations**
When specifications overlap, serial code is added in the recorded order.

Ordering Information

Package	Contact form	Terminals	Load voltage (peak value) *	Continuous load current (peak value) *	Tape cut packaging		Tape packaging	
					Model	Minimum package quantity	Model	Minimum package quantity
VSON4	1a (SPST-NO)	Surface-mounting Terminals	20 V	200 mA	G3VM-21UR10	1 pc.	G3VM-21UR10(TR05)	500 pcs.
				450 mA	G3VM-21UR1		G3VM-21UR1(TR05)	
				1,000 mA	G3VM-21UR11		G3VM-21UR11(TR05)	

Note: To order tape packaging for Relays with surface-mounting terminals, add "(TR05)" to the end of the model number. Tape-cut VSONs are packaged without humidity resistance. Use manual soldering to mount them. Refer to common precautions.

* The AC peak and DC value are given for the load voltage and continuous load current.

■Absolute Maximum Ratings (Ta = 25°C)

Item		Symbol	G3VM-21UR10	G3VM-21UR1	G3VM-21UR11	Unit	Measurement conditions
Input	LED forward current	IF	30			mA	
	LED forward current reduction rate	$\Delta I_F/^\circ\text{C}$	-0.3			$\text{mA}/^\circ\text{C}$	Ta \geq 25°C
	LED reverse voltage	VR	5			V	
	Connection temperature	TJ	125			°C	
Output	Load voltage (AC peak/DC)	VOFF	20			V	
	Continuous load current (AC peak/DC)	Io	200	450	1,000	mA	
	ON current reduction rate	$\Delta I_O/^\circ\text{C}$	-2	-4.5	-10	$\text{mA}/^\circ\text{C}$	Ta \geq 25°C
	Pulse ON current	Iop	0.6	1.3	3	A	t=100 ms, Duty=1/10
	Connection temperature	TJ	125			°C	
	Dielectric strength between I/O *	Vi-o	300			Vrms	AC for 1 min
	Ambient operating temperature	Ta	-40 to +85			°C	With no icing or condensation
Ambient storage temperature	Tstg	-40 to +125			°C		
Soldering temperature	-	260			°C	10 s	

* The dielectric strength between the input and output was checked by applying voltage between all pins as a group on the LED side and all pins as a group on the light-receiving side.

■Electrical Characteristics (Ta = 25°C)

Item		Symbol	G3VM-21UR10	G3VM-21UR1	G3VM-21UR11	Unit	Measurement conditions
Input	LED forward voltage	Minimum	1.1			V	IF=10 mA
		Typical	1.27				
		Maximum	1.4				
	Reverse current	IR	10			μA	VR=5 V
Capacitance between terminals	CT	30			pF	V=0, f=1 MHz	
Trigger LED forward current	IFT	Typical	1	0.6	-	mA	Io=100 mA
		Maximum	3				
Release LED forward current	IFC	Minimum	0.1			mA	I _{OFF} =10 μA
Maximum resistance with output ON	RON	Typical	3	0.8	0.18	Ω	IF=5 mA, t \leq 1 s, Io=Continuous load current ratings
		Maximum	5	1.2	0.22		
Current leakage when the relay is open	I _{LEAK}	Maximum	1			nA	V _{OFF} =20 V
Capacitance between terminals	COFF	Typical	0.8	5	40	pF	V=0, f=100 MHz, t \leq 1 s
		Maximum	1.1	12	-		
Capacitance between I/O terminals	CI-O	Typical	1		0.4	pF	f=1 MHz, Vs=0 V
Insulation resistance between I/O terminals	Ri-O	Typical	10 ⁸			M Ω	Vi-o=500 VDC, RoH \leq 60%
Turn-ON time	tON	Typical	0.05	0.17	-	ms	IF=5 mA, RL=200 Ω , V _{DD} =10 V *
		Maximum	0.2	0.4	2		
Turn-OFF time	tOFF	Typical	0.02		-	ms	IF=5 mA, RL=200 Ω , V _{DD} =10 V *
		Maximum	0.2	0.4	1		

* Turn-ON and Turn-OFF Times

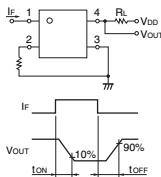

■Recommended Operating Conditions

For usage with high reliability, Recommended Operation Conditions is a measure that takes into account the derating of Absolute Maximum Ratings and Electrical Characteristics.

Each item on this list is an independent condition, so it is not simultaneously satisfy several conditions.

Item	Symbol	G3VM-21UR10	G3VM-21UR1	G3VM-21UR11	Unit
Load voltage (AC peak/DC)	VDD	Maximum		16	V
		Minimum		5	
Operating LED forward current	IF	Typical		7.5	mA
		Maximum		20	
		Maximum	200	450	
Ambient operating temperature	Ta	Minimum		-20	°C
	Maximum		65		

G3VM-21UR□

MOS FET Relays

Engineering Data

LED forward current vs. Ambient temperature

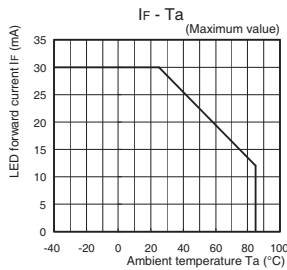

Continuous load current vs. Ambient temperature

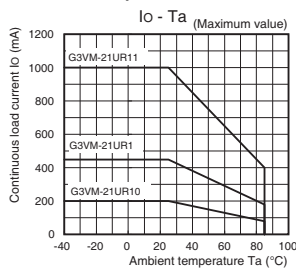

LED forward current vs. LED forward voltage

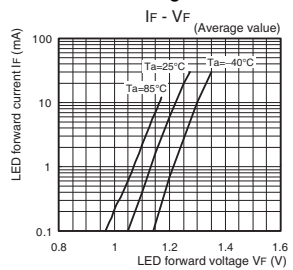

Continuous load current vs. On-state voltage

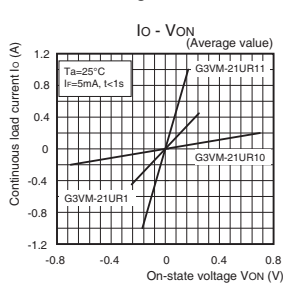

On-state resistance vs. Ambient temperature

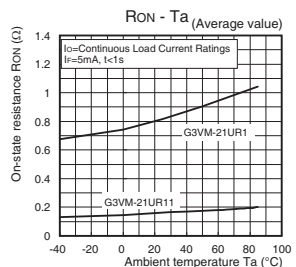

G3VM-21UR10

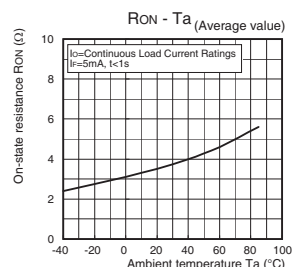

Trigger LED forward current vs. Ambient temperature

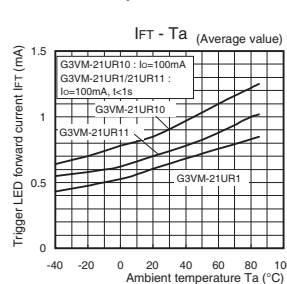

Turn ON, Turn OFF time vs. LED forward current

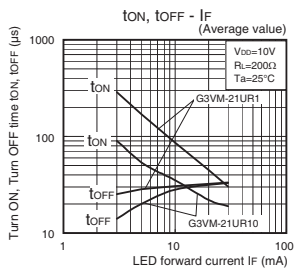

G3VM-21UR11

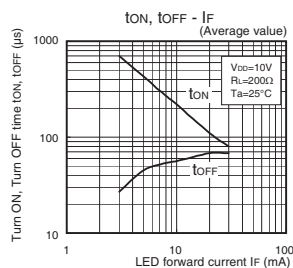

Engineering Data

Turn ON, Turn OFF time vs. Ambient temperature G3VM-21UR10/21UR1

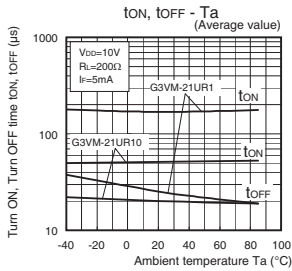

Output terminal capacitance vs. Load voltage

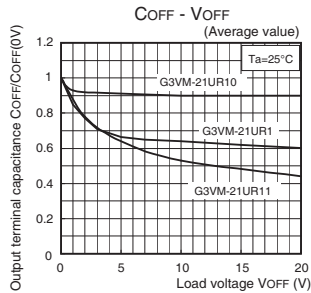

G3VM-21UR11

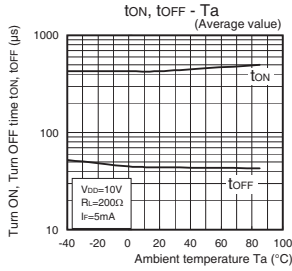

Current leakage vs. Load voltage

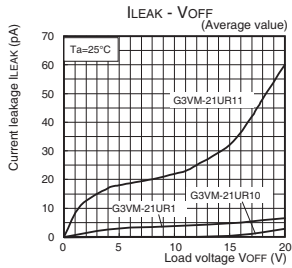

Current leakage vs. Ambient temperature

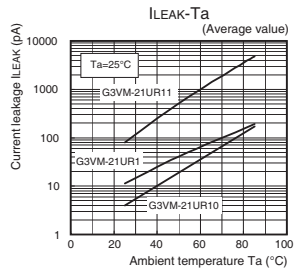

G3VM-21UR□

MOS FET Relays

■ Appearance / Terminal Arrangement / Internal Connections

● Appearance

VSON (Very Small Outline Non-leaded)

VSON 4-pin

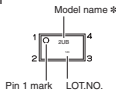

* Actual model name marking for each model

Model	Marking
G3VM-21UR10	2UA
G3VM-21UR1	2U1
G3VM-21UR11	2UB

Note: 1. The actual product is marked differently from the image shown here.

Note: 2. "G3VM" does not appear in the model number on the Relay.

● Terminal Arrangement/Internal Connections (Top View)

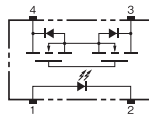

■ Dimensions (Unit: mm)

Surface-mounting Terminals

Weight: 0.01 g

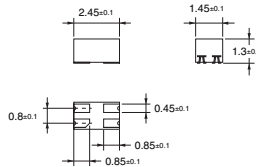
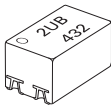

Note: The actual product is marked differently from the image shown here.

Actual Mounting Pad Dimensions

(Recommended Value, Top View)

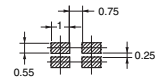
Unless otherwise specified, the dimensional tolerance is ± 0.1 mm.

■ Approved Standards

Applying for UL recognition

■ Safety Precautions

- Refer to the *Common Precautions for All MOS FET Relays* for precautions that apply to all MOS FET Relays.

G3VM-41UR□/51UR

MOS FET Relays VSON, Low-output-capacitance and Low-ON-resistance Type (with Low C × R)

World's smallest class New VSON Package with Low Output Capacitance and Low ON Resistance

- Load voltage: 40 V or 50 V
- G3VM-41UR12: Low C × R = 4.5 pF·Ω, C_{OFF} (standard) = 0.3 pF, R_{ON} (standard) = 15 Ω
- G3VM-41UR10: Low C × R = 5.4 pF·Ω, C_{OFF} (standard) = 0.45 pF, R_{ON} (standard) = 12 Ω
- G3VM-41UR11: Low C × R = 4.9 pF·Ω, C_{OFF} (standard) = 0.7 pF, R_{ON} (standard) = 7 Ω
- G3VM-51UR: Low C × R = 12 pF·Ω, C_{OFF} (standard) = 12 pF, R_{ON} (standard) = 1 Ω

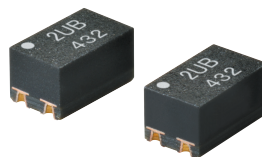

Note: The actual product is marked differently from the image shown here.

RoHS Compliant

Application Examples

- Semiconductor test equipment
- Communication equipment
- Test & measurement equipment
- Data loggers

Package (Unit : mm, Average)

VSON 4-pin

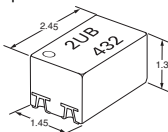

Note: The actual product is marked differently from the image shown here.

Model Number Legend

G3VM-□□□□□
1 2 3 4 5

1. Load Voltage

- 4: 40 V
- 5: 50 V

4. Additional functions

- R: Low On-resistance

2. Contact form

- 1: 1a (SPST-NO)

3. Package

- U: VSON 4-pin

5. Other informations

When specifications overlap, serial code is added in the recorded order.

Ordering Information

Package	Contact form	Terminals	Load voltage (peak value) *	Continuous load current (peak value) *	Tape cut packaging		Tape packaging	
					Model	Minimum package quantity	Model	Minimum package quantity
VSON4	1a (SPST-NO)	Surface-mounting Terminals	40 V	100 mA	G3VM-41UR12	1 pc.	G3VM-41UR12(TR05)	500 pcs.
				120 mA	G3VM-41UR10		G3VM-41UR10(TR05)	
				140 mA	G3VM-41UR11		G3VM-41UR11(TR05)	
			50 V	300 mA	G3VM-51UR		G3VM-51UR(TR05)	

Note: To order tape packaging for Relays with surface-mounting terminals, add "(TR05)" to the end of the model number.

Tape-cut VSONs are packaged without humidity resistance. Use manual soldering to mount them.

Refer to common precautions.

* The AC peak and DC value are given for the load voltage and continuous load current.

G3VM-41UR□/51UR

MOS FET Relays

■ Absolute Maximum Ratings (Ta = 25°C)

Item	Symbol	G3VM-41UR12	G3VM-41UR10	G3VM-41UR11	G3VM-51UR	Unit	Measurement conditions
LED forward current	IF	30				mA	
LED forward current reduction rate	$\Delta I_f/^\circ\text{C}$	-0.3				mA/°C	Ta=25°C
LED reverse voltage	VR	5				V	
Connection temperature	TJ	125				°C	
Load voltage (AC peak/DC)	V _{OFF}	40				V	
Continuous load current (AC peak/DC)	Io	100	120	140	300	mA	
ON current reduction rate	$\Delta I_o/^\circ\text{C}$	-1.0	-1.2	-1.4	-3	mA/°C	Ta=25°C
Pulse ON current	I _{op}	300	360	420	900	mA	t=100 ms, Duty=1/10
Connection temperature	TJ	125				°C	
Dielectric strength between I/O *	V _{IO}	300				V _{rms}	AC for 1 min
Ambient operating temperature	Ta	-40 to +85				°C	
Ambient storage temperature	T _{stg}	-40 to +125				°C	With no icing or condensation
Soldering temperature	-	260				°C	10 s

* The dielectric strength between the input and output was checked by applying voltage between all pins as a group on the LED side and all pins as a group on the light-receiving side.

■ Electrical Characteristics (Ta = 25°C)

Item	Symbol	G3VM-41UR12	G3VM-41UR10	G3VM-41UR11	G3VM-51UR	Unit	Measurement conditions	
Input	LED forward voltage	Minimum	1.1				V	I _f =10 mA
		Typical	1.27					
		Maximum	1.4					
Reverse current	I _R	10				μA	V _R =5 V	
Capacitance between terminals	C _T	30				pF	V=0, f=1 MHz	
Trigger LED forward current	I _{FT}	Typical	0.9	-	0.7	-	mA	I _o =100 mA
		Maximum	3					
Release LED forward current	I _{FC}	0.1				mA	I _{OFF} =10 μA	
Maximum resistance with output ON	R _{ON}	Typical	15	12	7	1	Ω	I _f =5 mA, t<1 s, I _o =Continuous load current ratings
		Maximum	20	14	10	1.5		
Current leakage when the relay is open	I _{LEAK}	1				nA	V _{OFF} =Load voltage ratings	
Capacitance between terminals	C _{OFF}	Typical	0.3	0.45	0.7	12	pF	V=0, f=100 MHz, t<1 s
		Maximum	0.6	0.8	1.3	20		
Capacitance between I/O terminals	C _{IO}	1				pF	f=1 MHz, V _s =0 V	
Insulation resistance between I/O terminals	R _{IO}	10 ⁸				MΩ	V _{IO} =500 VDC, R _{oH} ≤60%	
Turn-ON time	t _{ON}	Typical	0.05	-	0.06	-	ms	I _f =5 mA, R _L =200 Ω, V _{DD} =20 V *1
		Maximum	0.2					
Turn-OFF time	t _{OFF}	Typical	0.03	-	0.03	-	ms	I _f =5 mA, V _{DD} =0.25 V, Tr(in)=25 ps *2
		Maximum	0.2	0.3	0.2	0.4		
Equivalent rise time	ERT	Typical	-				ps	I _f =5 mA, V _{DD} =0.25 V, Tr(in)=25 ps *2
		Maximum	-					

*1. Turn-ON and Turn-OFF Times

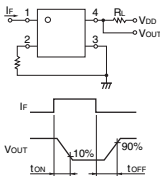

*2. Equivalent Rise Time

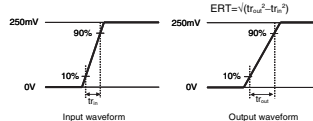

■ Recommended Operating Conditions

For usage with high reliability, Recommended Operation Conditions is a measure that takes into account the derating of Absolute Maximum Ratings and Electrical Characteristics.

Each item on this list is an independent condition, so it is not simultaneously satisfy several conditions.

Item	Symbol	G3VM-41UR12	G3VM-41UR10	G3VM-41UR11	G3VM-51UR	Unit
Load voltage (AC peak/DC)	V _{DD}	Maximum	32			V
		Minimum	40			
Operating LED forward current	I _f	Minimum	5			mA
		Typical	7.5			
		Maximum	20			
Continuous load current (AC peak/DC)	I _o	Maximum	100	120	140	300
		Minimum	-			
Ambient operating temperature	Ta	Minimum	-20			°C
		Maximum	65			

G3VM-41UR□/51UR

MOS FET Relays

Engineering Data

LED forward current vs. Ambient temperature

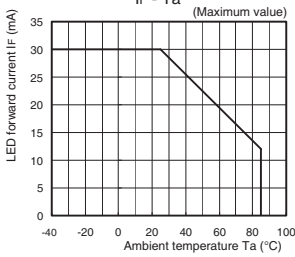

Continuous load current vs. Ambient temperature

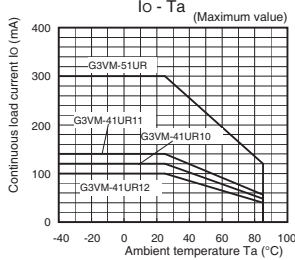

LED forward current vs. LED forward voltage

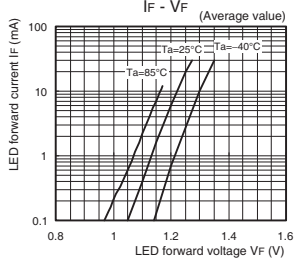

Continuous load current vs. On-state voltage

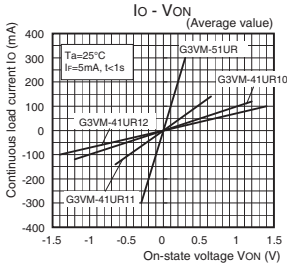

On-state resistance vs. Ambient temperature

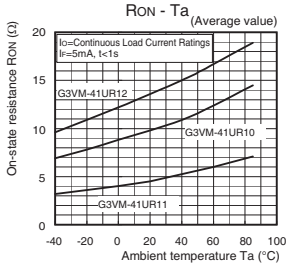

G3VM-51UR

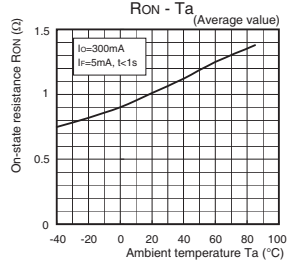

Trigger LED forward current vs. Ambient temperature

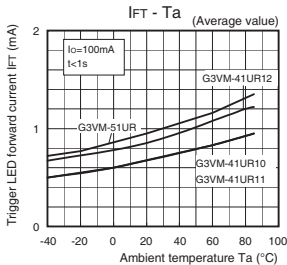

Turn ON, Turn OFF time vs. LED forward current

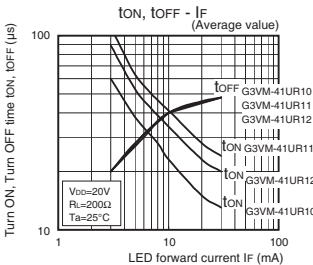

G3VM-51UR

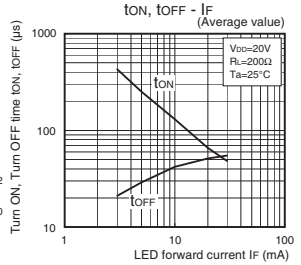

Introduction
General purpose
High-side voltage
Multi-contact pair (2a, 2b, and 1a1b)
High-current and high-on-resistance
Small and high-impedance strength
High-dielectric strength
Current-limiting and on-resistance
Low-voltage impedance and on-resistance
Small and High-impedance
Certified Models with Standards Certification
DIP
SOP
SSOP
USOP
VSON
MS-S

G3VM-41UR□/51UR

G3VM-41UR□/51UR

MOS FET Relays

Engineering Data

● **Turn ON, Turn OFF time vs. Ambient temperature**
G3VM-41UR12/41UR10/41UR11

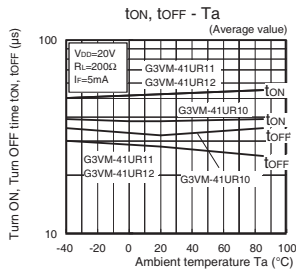

G3VM-51UR

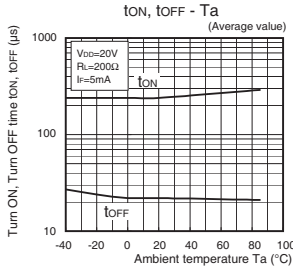

● **Current leakage vs. Load voltage**

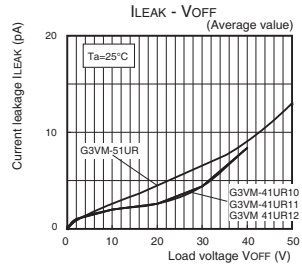

● **Current leakage vs. Ambient temperature**

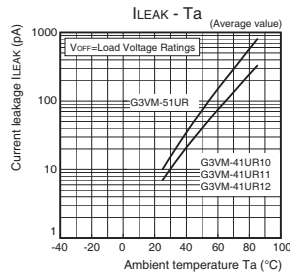

● **Output terminal capacitance vs. Load voltage**

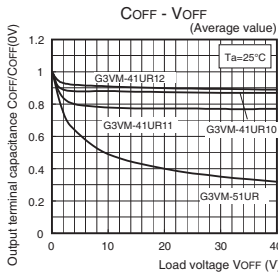

Introduction

General-purpose

High-load-voltage

Multi-contact-type (2A, 2A, and 1A)

High-current and Low-ON-resistance

Small and high-impedance-switching

High-electric-strength

Current-limiting

Terminal capacitance and low-ON-resistance

Small and High-load-voltage

Certified models with Standard Certification

DIP

SOP

SSOP

USOP

VSON

S-VSON

G3VM-41UR□/51UR

G3VM-41UR□/51UR

MOS FET Relays

■ Appearance / Terminal Arrangement / Internal Connections

● Appearance

VSON (Very Small Outline Non-leaded)

VSON 4-pin

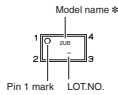

* Actual model name marking for each model

Model	Marking
G3VM-41UR12	4UC
G3VM-41UR10	4UA
G3VM-41UR11	4UB
G3VM-51UR	5U0

● Terminal Arrangement/Internal Connections (Top View)

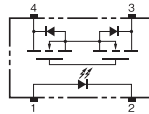

Note: 1. The actual product is marked differently from the image shown here.
Note: 2. "G3VM" does not appear in the model number on the Relay.

■ Dimensions (Unit: mm)

Surface-mounting Terminals

Weight: 0.01 g

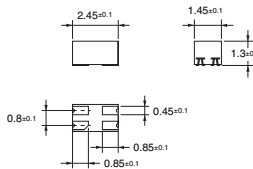
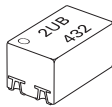

Actual Mounting Pad Dimensions

(Recommended Value, Top View)

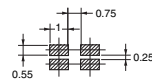

Unless otherwise specified, the dimensional tolerance is ± 0.1 mm.

Note: The actual product is marked differently from the image shown here.

■ Approved Standards

Applying for UL recognition

■ Safety Precautions

- Refer to the *Common Precautions for All MOS FET Relays* for precautions that apply to all MOS FET Relays.

G3VM-41QR10/61QR

MOS FET Relays S-VSON 4-pin, Low-output-capacitance and Low-ON-resistance Type (with Low C × R)

World's smallest class * New S-VSON Package with Low Output Capacitance and Low ON Resistance

- Load voltage: 40 V / 60 V.
- G3VM-41QR10: Low C × R = 4.95 pF·Ω, C_{OFF} (standard) = 0.45 pF, R_{ON} (standard) = 11 Ω
- G3VM-61QR: Low C × R = 13.2 pF·Ω, C_{OFF} (standard) = 12 pF, R_{ON} (standard) = 1.1 Ω
- High Ambient operating temperature: -40°C to +110°C

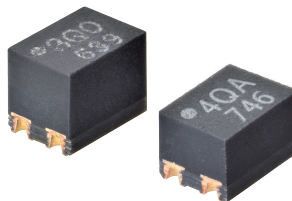
**NEW**

Note: The actual product is marked differently from the image shown here.

* As of March 2018 Survey by OMRON.

RoHS Compliant

Application Examples

- Semiconductor test equipment
- Test & measurement equipment
- Communication equipment
- Data loggers

Package (Unit: mm, Average)

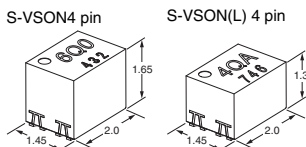

Note: The actual product is marked differently from the image shown here.

Model Number Legend

G3VM-□□□□□
1 2 3 4 5

1. Load Voltage

4: 40V

6: 60 V

4. Additional functions

R: Low On-resistance

2. Contact form Package type 3. Package type

1: 1a (SPST-NO)

Q: S-VSON 4 pin

S-VSON(L)* 4 pin

* (L): Low profile type

5. Other informations

When specifications overlap, serial code is added in the recorded order.

Ordering Information

Package type	Contact form	Terminals	Load voltage (peak value) *	Continuous load current (peak value) *	Packing/Tape cut		Packing/Tape & reel	
					Model	Minimum package quantity	Model	Minimum package quantity
S-VSON4(L)4	1a	Surface-mounting Terminals	40 V	120 mA	G3VM-41QR10	1 pc.	G3VM-41QR10 (TR05)	500 pcs.
S-VSON4	(SPST-NO)		60 V	400 mA	G3VM-61QR		G3VM-61QR (TR05)	

* The AC peak and DC value are given for the load voltage and continuous load current.

Note: When ordering tape packing, add "(TR05)" (500 pcs/reel) to the model number.

Ask your OMRON representative for orders under 500 pcs. We can supply products with the tape already cut. Tape-cut S-VSON is packaged without humidity resistance. Use manual soldering to mount them.

Refer to common precautions.

G3VM-41QR10/61QR

MOS FET Relays

■ Absolute Maximum Ratings (Ta = 25°C)

Item		Symbol	G3VM-41QR10	G3VM-61QR	Unit	Measurement conditions	
Input	LED forward current	I _F	30		mA		
	LED forward current reduction rate	ΔI _F /°C	-0.3		mA/°C	Ta ≥ 25°C	
	LED reverse voltage	V _R	6		V		
Connection temperature		T _J	125		°C		
Output	Load voltage (AC peak/DC)	V _{OFF}	40	60	V		
	Continuous load current (AC peak/DC)	I _o	120	400	mA		
	ON current reduction rate	ΔI _o /°C	-1.2	-4	mA/°C	Ta ≥ 25°C	
	Pulse ON current	I _{OP}	0.36	1.2	A	t = 100 ms, Duty = 1/10	
	Connection temperature		T _J	125		°C	
	Dielectric strength between I/O *		V _{i-o}	500		Vrms	AC for 1 min
Ambient operating temperature		T _a	-40 to +110		°C	With no icing or condensation	
Ambient storage temperature		T _{stg}	-40 to +125		°C		
Soldering temperature		-	260		°C	10 s	

* The dielectric strength between the input and output was checked by applying voltage between all pins as a group on the LED side and all pins as a group on the light-receiving side.

■ Electrical Characteristics (Ta = 25°C)

Item		Symbol	G3VM-41QR10	G3VM-61QR	Unit	Measurement conditions	
Input	LED forward voltage	Minimum	1.1		V	I _F = 10 mA	
		Typical	1.21				
		Maximum	1.4				
	Reverse current	I _R	Maximum	10	μA	V _R = 5 V	
	Capacity between terminals	C _T	Typical	30	pF	V = 0, f = 1 MHz	
Output	Trigger LED forward current	Typical	0.8	-	mA	I _o = 100 mA	
		Maximum	3				
	Release LED forward current	I _{FC}	Minimum	0.1	mA	I _{OFF} = 10 μA	
	Maximum resistance with output ON	R _{ON}	Typical	11	1.1	Ω	G3VM-41QR10: I _F = 5 mA, t < 1s, I _o = 120 mA G3VM-61QR: I _F = 5 mA, t < 1s, I _o = 400 mA
			Maximum	14	1.5		
Current leakage when the relay is open	I _{LEAK}	Maximum	1	1000 (1)	nA	G3VM-41QR10: V _{OFF} = 40 V G3VM-61QR: V _{OFF} = 60 V (V _{OFF} = 50 V)	
Capacity between terminals	C _{OFF}	Typical	0.45	12	pF	V = 0, f = 100 MHz, t < 1s	
		Maximum	0.8	20			
Capacity between I/O terminals	C _{I-O}	Typical	1	0.9	pF	f = 1 MHz, V _S = 0V	
Insulation resistance between I/O terminals	R _{I-O}	Typical	10 ⁸		MΩ	V _{i-o} = 500 VDC, RoHs60%	
Turn-ON time	t _{ON}	Typical	0.08	-	ms	I _F = 5 mA, R _L = 200 Ω, V _{DD} = 20 V I _F = 10 mA, R _L = 200 Ω, V _{DD} = 20 V *	
		Maximum	0.2	0.5 (0.25)			
Turn-OFF time	t _{OFF}	Typical	0.04	-	ms	I _F = 5 mA, R _L = 200 Ω, V _{DD} = 20 V *	
		Maximum	0.3	0.3 (0.3)			

* Turn-ON and Turn-OFF Times

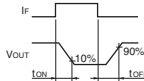
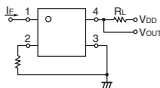

■ Recommended Operating Conditions

For usage with high reliability, Recommended Operation Conditions is a measure that takes into account the derating of Absolute Maximum Ratings and Electrical Characteristics.

Each item on this list is an independent condition, so it is not simultaneously satisfy several conditions.

Item	Symbol		G3VM-41QR10	G3VM-61QR	Unit
Load voltage (AC peak/DC)	V _{DD}	Maximum	32	48	V
		Minimum	5		
Operating LED forward current	I _F	Typical	7.5		mA
		Maximum	20		
		Minimum	-		
Continuous load current (AC peak/DC)	I _o	Maximum	120	400	
		Minimum	-20		
Ambient operating temperature	T _a	Minimum	-20		°C
		Maximum	85	100	

G3VM-41QR10/61QR

MOS FET Relays

■ Engineering Data

● LED forward current vs. Ambient temperature

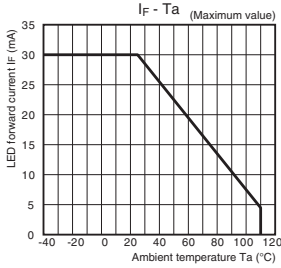

● Continuous load current vs. Ambient temperature

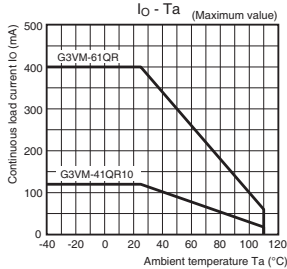

● LED forward current vs. LED forward voltage

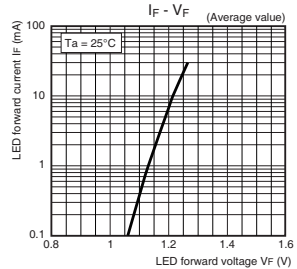

● Continuous load current vs. On-state voltage

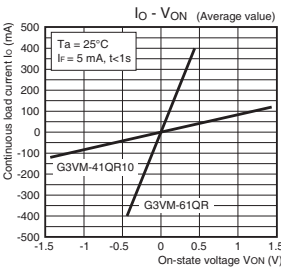

● On-state resistance vs. Ambient temperature

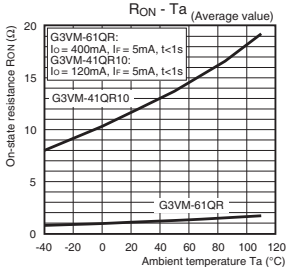

● Trigger LED forward current vs. Ambient temperature

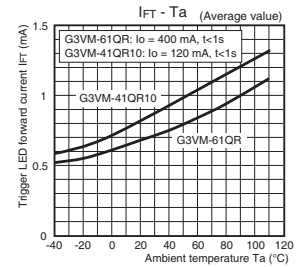

● Turn ON, Turn OFF time vs. LED forward current

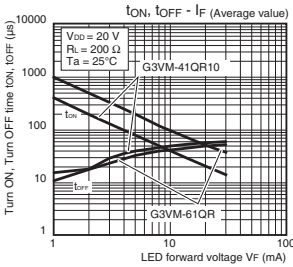

● Turn ON, Turn OFF time vs. Ambient temperature

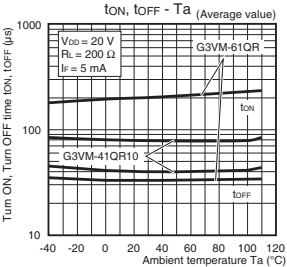

● Current leakage vs. Load voltage

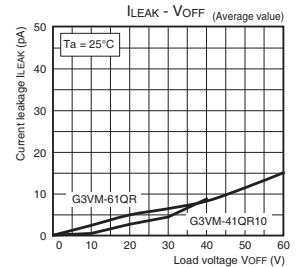

● Current leakage vs. Ambient temperature

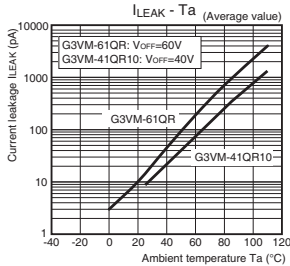

● Output terminal capacitance vs. Load voltage

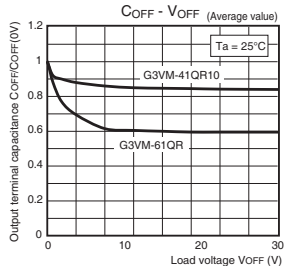

G3VM-41QR10/61QR

MOS FET Relays

Appearance / Terminal Arrangement / Internal Connections

Appearance

S-VSON (Super-Very Small Outline Non-leaded)

S-VSON4 pin / S-VSON(L)4 pin

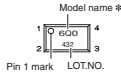

* Actual model name marking for each model

Model	Marking
G3VM-41QR10	4QA
G3VM-61QR	6Q0

Terminal Arrangement/Internal Connections (Top View)

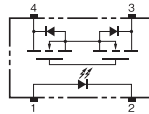

- Note 1.** The actual product is marked differently from the image shown here.
2. "G3VM" does not appear in the model number on the Relay.

Dimensions (Unit: mm)

S-VSON (Super-Very Small Outline Non-leaded)

S-VSON4 pin

Surface-mounting Terminals

Weight: 0.01 g

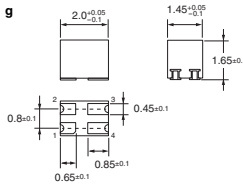
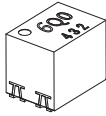

- Note:** The actual product is marked differently from the image shown here.
 S-VSON(L)4 pin

Surface-mounting Terminals

Weight: 0.01 g

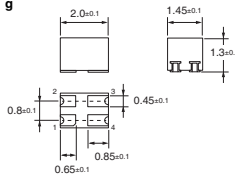
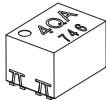

- Note:** The actual product is marked differently from the image shown here.

Safety Precautions

- Refer to "Common Precautions" for all G3VM models.

Actual Mounting Pad Dimensions

(Recommended Value, Top View)

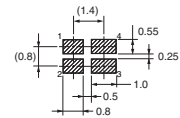

Unless otherwise specified, the dimensional tolerance is ± 0.1 mm.

Actual Mounting Pad Dimensions

(Recommended Value, Top View)

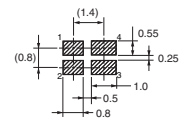

Unless otherwise specified, the dimensional tolerance is ± 0.1 mm.

G3VM-61LR/81LR/101LR

MOS FET Relays SSOP, Small and High-load-voltage Type

MOS FET Relays in SSOP packages for high load voltages

• Load voltage: 60 V, 80 V, or 100 V

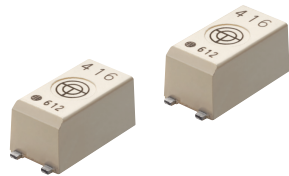

Note: The actual product is marked differently from the image shown here.

RoHS Compliant

Application Examples

- Semiconductor test equipment
- Communication equipment
- Test & Measurement equipment
- Data loggers

Package (Unit : mm, Average)

SSOP 4-pin

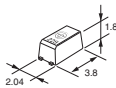

Note: The actual product is marked differently from the image shown here.

Model Number Legend

G3VM-□□□□□
1 2 3 4 5

- Load Voltage**
6 : 60 V
8 : 80 V
10 : 100 V
- Contact form**
1 : 1a (SPST-NO)
- Package**
L : SSOP 4-pin

- Additional functions**
R : Low ON resistance

- Other informations**
When specifications overlap, serial code is added in the recorded order.

Ordering Information

Package	Contact form	Terminals	Load voltage (peak value) *	Continuous load current (peak value) *	Tape cut packaging		Tape packaging	
					Model	Minimum package quantity	Model	Minimum package quantity
SSOP4	1a (SPST-NO)	Surface-mounting Terminals	60 V	400 mA	G3VM-61LR	1 pc.	G3VM-61LR(TR05)	500 pcs.
			80 V	120 mA	G3VM-81LR		G3VM-81LR(TR05)	
			100 V	80 mA	G3VM-101LR		G3VM-101LR(TR05)	

* The AC peak and DC value are given for the load voltage and continuous load current.

Note: To order tape packaging for Relays with surface-mounting terminals, add "(TR05)" to the end of the model number.

Tape-cut SSOPs are packaged without humidity resistance. Use manual soldering to mount them. Refer to common precautions.

Absolute Maximum Ratings (Ta = 25°C)

Item	Symbol	G3VM-61LR	G3VM-81LR	G3VM-101LR	Unit	Measurement conditions	
Input	LED forward current	IF	50		mA		
	LED forward current reduction rate	ΔIF/C	-0.5		mA/°C	Ta ≥ 25°C	
	LED reverse voltage	VR	5		V		
	Connection temperature	TJ	125		°C		
Output	Load voltage (AC peak/DC)	VOFF	60	80	100	V	
	Continuous load current (AC peak/DC)	Io	400	120	80	mA	
	ON current reduction rate	ΔIo/°C	-4	-1.2	-0.8	mA/°C	Ta ≥ 25°C
	Pulse ON current	Iop	1200	360	240	mA	t=100 ms, Duty=1/10
	Connection temperature	TJ	125		°C		
	Dielectric strength between I/O *	Vi-o	1500		Vrms	AC for 1 min	
	Ambient operating temperature	Ta	-20 to +85		°C	With no icing or condensation	
	Ambient storage temperature	Tstg	-40 to +125		°C		
Soldering temperature	-	260		°C	10 s		

* The dielectric strength between the input and output was checked by applying voltage between all pins as a group on the LED side and all pins as a group on the light-receiving side.

G3VM-61LR/81LR/101LR

MOS FET Relays

■Electrical Characteristics (Ta = 25°C)

Item	Symbol		G3VM-61LR	G3VM-81LR	G3VM-101LR	Unit	Measurement conditions
LED forward voltage	V _F	Minimum	1.0			V	I _F =10 mA
		Typical	1.15				
		Maximum	1.3				
Reverse current	I _R	Maximum	10			μA	V _R =5 V
Capacitance between terminals	C _T	Typical	15			pF	V=0, f=1 MHz
Trigger LED forward current	I _{FT}	Typical	2		1	mA	G3VM-61LR : I _o =100 mA G3VM-81LR : I _o =120 mA G3VM-101LR : I _o =80 mA
		Maximum	5				
Release LED forward current	I _{FC}	Minimum	0.2	0.1	0.2	mA	G3VM-61LR/81LR : I _{oFF} =10 μA G3VM-101LR : I _{oFF} =1 μA
Maximum resistance with output ON	R _{ON}	Typical	1	7.5	8	Ω	G3VM-61LR : I _F =5 mA, I _o =Continuous load current ratings G3VM-81LR/101LR : I _F =10 mA, I _o =Continuous load current ratings, t=10 ms
		Maximum	1.5	12	14		
Current leakage when the relay is open	I _{LEAK}	Maximum	1,000			nA	G3VM-61LR : V _{oFF} =60 V G3VM-81LR : V _{oFF} =80 V, Ta=60°C G3VM-101LR : V _{oFF} =80 V
Capacitance between terminals	C _{OFF}	Typical	20	5	6	pF	V=0, f=100 MHz, t<1 s
		Maximum	30	7	8		
Capacitance between I/O terminals	C _{I-O}	Typical	0.3	0.8	0.6	pF	f=1 MHz, V _S =0 V
Insulation resistance between I/O terminals	R _{I-O}	Minimum	1000			MΩ	V _{I-O} =500 VDC, RoHS≤60%
		Typical	10 ⁶				
Turn-ON time	t _{ON}	Typical	0.3			ms	G3VM-81LR : I _F =10 mA, R _L =200 Ω, V _{oD} =20 V G3VM-61LR/101LR : I _F =5 mA, R _L =200 Ω, V _{oD} =20 V *
		Maximum	1	0.25	0.3		
Turn-OFF time	t _{OFF}	Typical	0.2			ms	G3VM-81LR : I _F =10 mA, R _L =200 Ω, V _{oD} =20 V G3VM-61LR/101LR : I _F =5 mA, R _L =200 Ω, V _{oD} =20 V *
		Maximum	1	0.2	0.3		

* Turn-ON and Turn-OFF Times

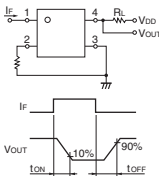

■Recommended Operating Conditions

For usage with high reliability, Recommended Operation Conditions is a measure that takes into account the derating of Absolute Maximum Ratings and Electrical Characteristics.

Each item on this list is an independent condition, so it is not simultaneously satisfy several conditions.

Item	Symbol		G3VM-61LR	G3VM-81LR	G3VM-101LR	Unit
Load voltage (AC peak/DC)	V _{oD}	Maximum	48	64	80	V
Operating LED forward current	I _F	Minimum	10			mA
		Maximum	20	30		
Continuous load current (AC peak/DC)	I _o	Maximum	400	120	80	
Ambient operating temperature	T _a	Minimum	-20			°C
		Maximum	70	60		

■Spacing and Insulation

Item	Minimum	Unit
Creepage distances	2.5	mm
Clearance distances	2.5	
Internal isolation thickness	0.1	

G3VM-61LR/81LR/101LR

MOS FET Relays

Engineering Data

LED forward current vs. Ambient temperature

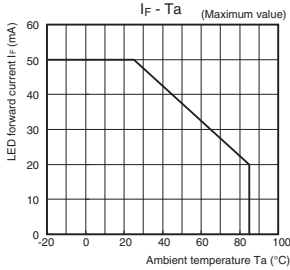

Continuous load current vs. Ambient temperature

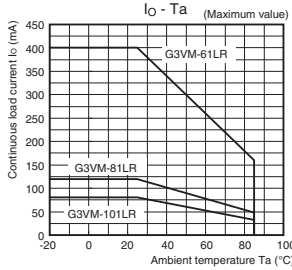

LED forward current vs. LED forward voltage

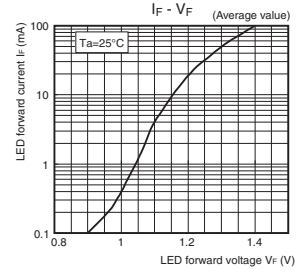

Continuous load current vs. On-state voltage

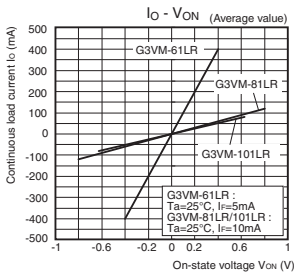

On-state resistance vs. Ambient temperature

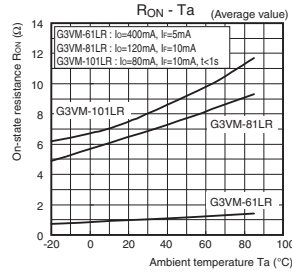

Trigger LED forward current vs. Ambient temperature

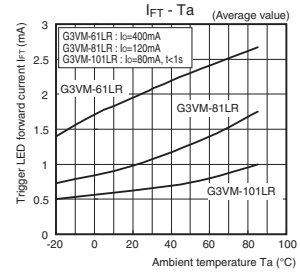

Turn ON, Turn OFF time vs. LED forward current

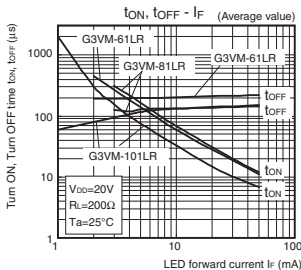

Turn ON, Turn OFF time vs. Ambient temperature

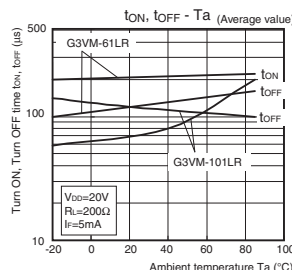

G3VM-81LR

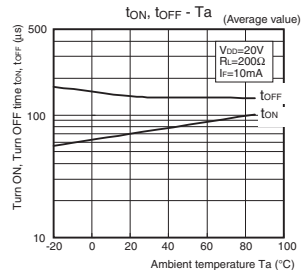

Current leakage vs. Ambient temperature

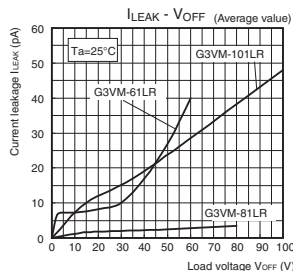

Output terminal capacitance vs. Load voltage

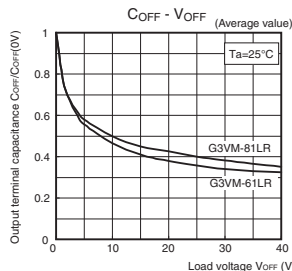

G3VM-101LR

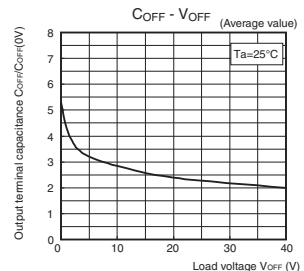

G3VM-61LR/81LR/101LR

MOS FET Relays

■ Appearance / Terminal Arrangement / Internal Connections

● Appearance

SSOP (Shrink Small Outline Package)
SSOP 4-pin

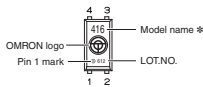

* Actual model name marking for each model

Model	Marking
G3VM-61LR	610
G3VM-81LR	810
G3VM-101LR	101

Note 1: The actual product is marked differently from the image shown here.
Note 2: "G3VM" does not appear in the model number on the Relay.

● Terminal Arrangement/ Internal Connections (Top View)

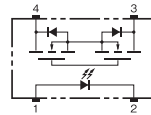

■ Dimensions (Unit: mm)



Surface-mounting Terminals

Weight: 0.03 g

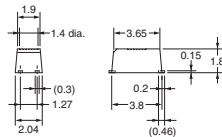

Unless otherwise specified, the dimensional tolerance is ± 0.1 mm.

Actual Mounting Pad Dimensions (Recommended Value, TOP VIEW)

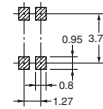

Note: The actual product is marked differently from the image shown here.

■ Approved Standards

UL recognized 

Approved Standards	Contact form	File No.
UL (recognized)	1a (SPST-NO)	E80555

■ Safety Precautions

- Refer to the *Common Precautions for All MOS FET Relays* for precautions that apply to all MOS FET Relays.

G3VM-61PR□/71PR/81PR/101PR

MOS FET Relays USOP, Small and High-load-voltage Type

USOP Package with High Load voltage

- Load voltage: 60 V, 75 V, 80 V, or 100 V
- G3VM-61PR1: Low $C \times R = 7 \text{ pF} \cdot \Omega$, C_{OFF} (standard) = 0.7 pF, R_{ON} (standard) = 10 Ω

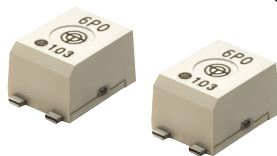

Note: The actual product is marked differently from the image shown here.

RoHS Compliant

Application Examples

- Semiconductor test equipment
- Communication equipment
- Test & measurement equipment
- Data loggers

Package (Unit : mm, Average)

USOP 4-pin

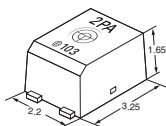

Note: The actual product is marked differently from the image shown here.

Model Number Legend

G3VM-□□□□□
1 2 3 4 5

1. Load Voltage

- 6: 60 V
- 7: 75 V
- 8: 80 V
- 10: 100 V

2. Contact form

- 1: 1a (SPST-NO)

4. Additional functions

- R: Low On-resistance

3. Package

- P: USOP 4-pin

5. Other informations

- When specifications overlap, serial code is added in the recorded order.

Ordering Information

Package	Contact form	Terminals	Load voltage (peak value) *	Continuous load current (peak value) *	Tape cut packaging		Tape packaging	
					Model	Minimum package quantity	Model	Minimum package quantity
USOP4	1a (SPST-NO)	Surface-mounting Terminals	60 V	120 mA	G3VM-61PR1	1 pc.	G3VM-61PR1(TR05)	500 pcs.
			75 V	400 mA	G3VM-61PR		G3VM-61PR(TR05)	
			80 V	120 mA	G3VM-71PR		G3VM-71PR(TR05)	
			100 V	100 mA	G3VM-81PR		G3VM-81PR(TR05)	
						G3VM-101PR	G3VM-101PR(TR05)	

Note: To order tape packaging for Relays with surface-mounting terminals, add "(TR05)" to the end of the model number.

Tape-cut USOPs are packaged without humidity resistance. Use manual soldering to mount them.

Refer to common precautions.

* The AC peak and DC value are given for the load voltage and continuous load current.

G3VM-61PR□/71PR/81PR/101PR**MOS FET Relays****■Absolute Maximum Ratings (Ta = 25°C)**

Item		Symbol	G3VM-61PR1	G3VM-61PR	G3VM-71PR	G3VM-81PR	G3VM-101PR	Unit	Measurement conditions
Input	LED forward current	IF	50					mA	Ta≥25°C
	LED forward current reduction rate	ΔIf/°C	-0.5					mA/°C	
	LED reverse voltage	Vr	5					V	
Connection temperature		Tj	125					°C	
Output	Load voltage (AC peak/DC)	Voff	60		75	80	100	V	
	Continuous load current (AC peak/DC)	Io	120	400		120	100	mA	
	ON current reduction rate	ΔIo/°C	-1.2	-4		-1.2	-1	mA/°C	Ta≥25°C
	Pulse ON current	Iop	360	1,200		360	300	mA	t=100 ms, Duty=1/10
	Connection temperature	Tj	125					°C	
	Dielectric strength between I/O *	Vl-o	500					Vrms	AC for 1 min
Ambient operating temperature		Ta	-40 to +85					°C	With no icing or condensation
Ambient storage temperature		Tstg	-40 to +125					°C	
Soldering temperature		-	260					°C	10 s

* The dielectric strength between the input and output was checked by applying voltage between all pins as a group on the LED side and all pins as a group on the light-receiving side.

■Electrical Characteristics (Ta = 25°C)

Item		Symbol	G3VM-61PR1	G3VM-61PR	G3VM-71PR	G3VM-81PR	G3VM-101PR	Unit	Measurement conditions		
Input	LED forward voltage	VF	Minimum	1.0				V	If=10 mA		
			Typical	1.15							
			Maximum	1.3							
	Reverse current	IR	Maximum				10	μA	Vr=5 V		
Capacitance between terminals		CT	Typical				15	pF	V=0, f=1 MHz		
Trigger LED forward current	IFT	Typical	1.0	0.5		0.6	0.5	mA	Io=100 mA		
		Maximum	3								
Release LED forward current		IFC	Minimum	0.1	0.2	0.1		mA	IOFF=10 μA		
			Typical	10	1		7			8	
Output	Maximum resistance with output ON		RON	Minimum	1		0.1		Ω	G3VM-61PR : If=5 mA, Io=400 mA Others : If=5 mA, Io=Continuous load current ratings, t<1 s	
				Maximum	15	1.5		12			14
	Current leakage when the relay is open		I _{LEAK}	Maximum	1			0.02	0.2	nA	Voff=Load voltage ratings
				Typical	0.7	20	30	5	6	pF	G3VM-61PR : V=0, f=1 MHz, t<1 s Others : V=0, f=100 MHz, t<1 s
Capacitance between terminals		COFF	Maximum	1.3	30	-	7	8			
Capacitance between I/O terminals		Cl-o	Typical	0.4	0.3	0.4		pF	f=1 MHz, Vs=0 V		
Insulation resistance between I/O terminals		Rl-o	Maximum	1000				MΩ	Vi-o=500 VDC, RoH≤60%		
			Typical	10 ⁹							
Turn-ON time		TON	Typical	0.04	0.3	0.4	0.14	0.12	ms	If=5 mA, Rt=200 Ω, VDD=20 V *	
			Maximum	0.2	0.5	2	0.5	0.3			
Turn-OFF time		TOFF	Typical	0.12	0.3	0.2	0.16	0.18			
			Maximum	0.2	0.5	1	0.2	0.3			

* Turn-ON and Turn-OFF Times

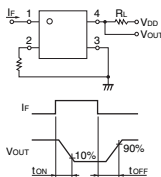
**■Recommended Operating Conditions**

For usage with high reliability, Recommended Operation Conditions is a measure that takes into account the derating of Absolute Maximum Ratings and Electrical Characteristics.

Each item on this list is an independent condition, so it is not simultaneously satisfy several conditions.

Item		Symbol	G3VM-61PR1	G3VM-61PR	G3VM-71PR	G3VM-81PR	G3VM-101PR	Unit	
Load voltage (AC peak/DC)		VDD	Maximum		48	60	64	80	V
Operating LED forward current	IF	Minimum					5	mA	
		Typical					7.5		
		Maximum					20		
Continuous load current (AC peak/DC)		Io	Maximum	120	400		120	100	
Ambient operating temperature		Ta	Minimum					-20	°C
			Maximum					65	

G3VM-61PR□/71PR/81PR/101PR

MOS FET Relays

Engineering Data

LED forward current vs. Ambient temperature

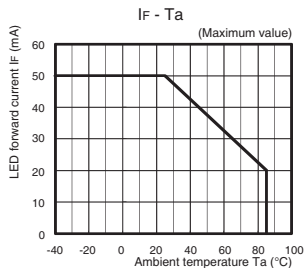

Continuous load current vs. Ambient temperature

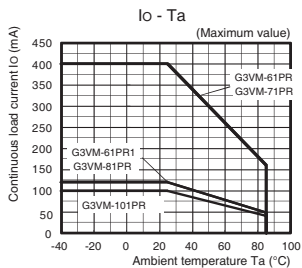

LED forward current vs. LED forward voltage

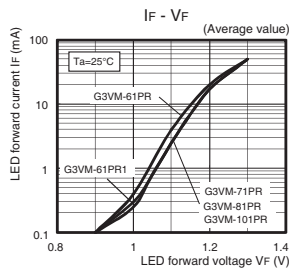

Continuous load current vs. On-state voltage

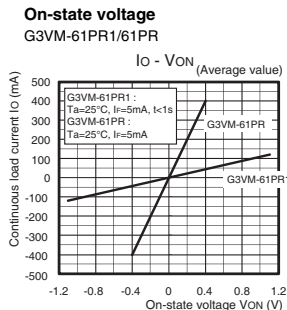

G3VM-71PR/81PR/101PR

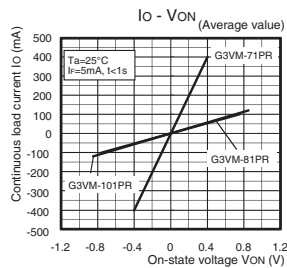

On-state resistance vs. Ambient temperature

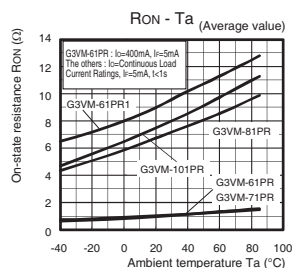

Trigger LED forward current vs. Ambient temperature

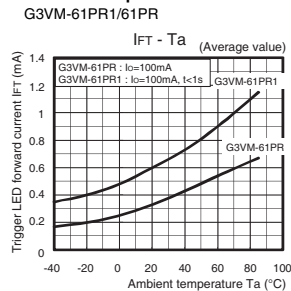

G3VM-71PR/81PR/101PR

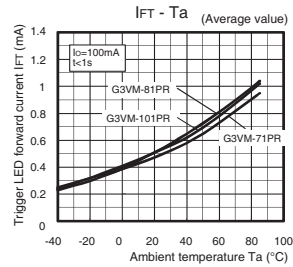

Turn ON, Turn OFF time vs. LED forward current

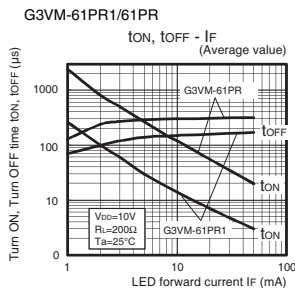

G3VM-71PR/81PR/101PR

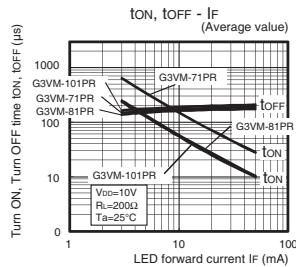

Engineering Data

Turn ON, Turn OFF time vs. Ambient temperature

G3VM-61PR1/61PR

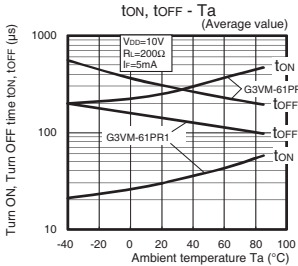

Output terminal capacitance vs. Load voltage

G3VM-61PR1/61PR

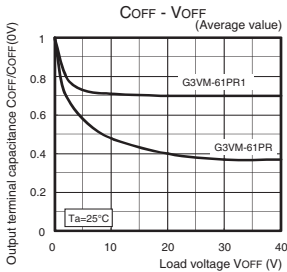

G3VM-71PR/81PR/101PR

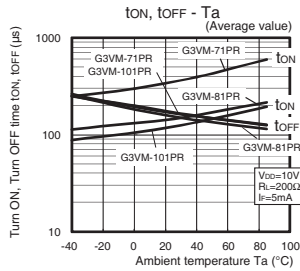

G3VM-71PR/81PR/101PR

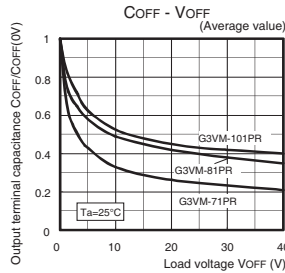

Current leakage vs. Load voltage

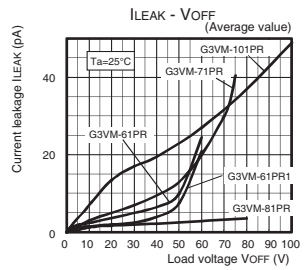

Current leakage vs. Ambient temperature

G3VM-71PR

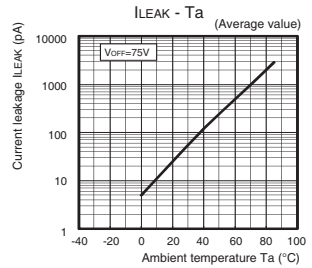

G3VM-61PR□/71PR/81PR/101PR

MOS FET Relays

■ Appearance / Terminal Arrangement / Internal Connections

● Appearance

USOP (Ultra Small Outline Package)

USOP 4-pin

* Actual model name marking for each model

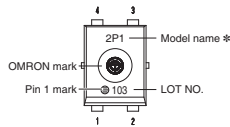

Model	Marking
G3VM-61PR1	6P1
G3VM-61PR	6P0
G3VM-71PR	7P0
G3VM-81PR	8P0
G3VM-101PR	AP0

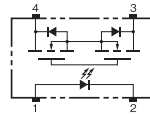

Note: 1. The actual product is marked differently from the image shown here.

Note: 2. "G3VM" does not appear in the model number on the Relay.

■ Dimensions (Unit: mm)

Surface-mounting Terminals

Weight: 0.03 g

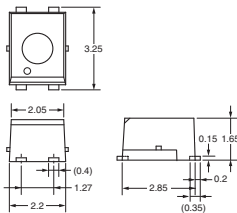
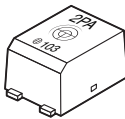

Unless otherwise specified, the dimensional tolerance is ± 0.2 mm.

Actual Mounting Pad Dimensions

(Recommended Value, Top View)

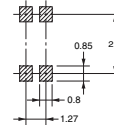

Unless otherwise specified, the dimensional tolerance is ± 0.2 mm.

Note: The actual product is marked differently from the image shown here.

■ Approved Standards

UL recognized



Approved Standards	Contact form	File No.
UL recognized	1a (SPST-NO)	E80555

■ Safety Precautions

- Refer to the *Common Precautions for All MOS FET Relays* for precautions that apply to all MOS FET Relays.

G3VM-61UR□/81UR□/101UR

MOS FET Relays VSON, Small and High-load-voltage Type

World's smallest class New VSON Package with High Load voltage

- Load voltage: 60 V, 80 V, or 100 V
- G3VM-61UR1: Low $C \times R = 7 \text{ pF} \cdot \Omega$, C_{OFF} (standard) = 0.7 pF,
 R_{ON} (standard) = 10 Ω

RoHS Compliant

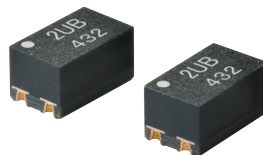

Note: The actual product is marked differently from the image shown here.

Application Examples

- Semiconductor test equipment
- Communication equipment
- Test & measurement equipment
- Data loggers

Package (Unit : mm, Average)

VSON 4-pin

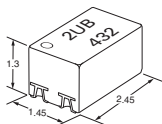

Note: The actual product is marked differently from the image shown here.

Model Number Legend

G3VM-□□□□□
 1 2 3 4 5

1. Load Voltage

- 6: 60 V
- 8: 80 V
- 10: 100 V

2. Contact form

- 1: 1a (SPST-NO)

4. Additional functions

- R: Low On-resistance

3. Package

- U: VSON 4-pin

5. Other informations

When specifications overlap, serial code is added in the recorded order.

Ordering Information

Package	Contact form	Terminals	Load voltage (peak value) *	Continuous load current (peak value) *	Tape cut packaging		Tape packaging	
					Model	Minimum package quantity	Model	Minimum package quantity
VSON4	1a (SPST-NO)	Surface-mounting Terminals	60 V	120 mA	G3VM-61UR1	1 pc.	G3VM-61UR1(TR05)	500 pcs.
				400 mA	G3VM-61UR		G3VM-61UR(TR05)	
			80 V	120 mA	G3VM-81UR		G3VM-81UR(TR05)	
				200 mA	G3VM-81UR1		G3VM-81UR1(TR05)	
100 V	100 mA	G3VM-101UR	G3VM-101UR(TR05)					

Note: To order tape packaging for Relays with surface-mounting terminals, add "(TR05)" to the end of the model number.

Tape-cut VSONs are packaged without humidity resistance. Use manual soldering to mount them.

Refer to common precautions.

* The AC peak and DC value are given for the load voltage and continuous load current.

G3VM-61UR□/81UR□/101UR

MOS FET Relays

■ Absolute Maximum Ratings (Ta = 25°C)

Item	Symbol	G3VM-61UR□	G3VM-61UR	G3VM-81UR	G3VM-81UR1	G3VM-101UR	Unit	Measurement conditions	
Input	LED forward current	IF	30				mA		
	LED forward current reduction rate	$\Delta I_F/\%$	-0.3				mA/°C	Ta=25°C	
	LED reverse voltage	Vr	5				V		
Connection temperature		Tj	125				°C		
Output	Load voltage (AC peak/DC)	V _{OFF}	60		80		100	V	
	Continuous load current (AC peak/DC)	I _o	120	400	120	200	100	mA	
	ON current reduction rate	$\Delta I_o/\%$	-1.2	-4.0	-1.2	-2	-1	mA/°C	Ta=25°C
	Pulse ON current	I _{op}	360	1200	360	600	300	mA	t=100 ms, Duty=1/10
	Connection temperature		Tj	125				°C	
	Dielectric strength between I/O *		V _{i-o}	300				V _{rms}	AC for 1 min
Ambient operating temperature		Ta	-40 to +85				°C		
Ambient storage temperature		T _{stg}	-40 to +125				°C	With no icing or condensation	
Soldering temperature		-	260				°C	10 s	

* The dielectric strength between the input and output was checked by applying voltage between all pins as a group on the LED side and all pins as a group on the light-receiving side.

■ Electrical Characteristics (Ta = 25°C)

Item	Symbol	G3VM-61UR□	G3VM-61UR	G3VM-81UR	G3VM-81UR1	G3VM-101UR	Unit	Measurement conditions	
Input	LED forward voltage	Minimum	1.1				V	I _F =10 mA	
		Typical	1.27						
		Maximum	1.4						
Reverse current	I _r	10				μA	V _R =5 V		
Capacitance between terminals	C _T	30				pF	V=0, f=1 MHz		
Output	Trigger LED forward current	Typical	3				mA	I _o =100 mA	
		Maximum	3						
	Release LED forward current	I _{FC}	0.1				mA	I _{OFF} =10 μA	
Maximum resistance with output ON	R _{ON}	Typical	10	1.0	7	6	8	Ω	I _F =5 mA, t<1 s, I _o =Continuous load current ratings
		Maximum	15	1.5	12	8	14		
Current leakage when the relay is open	I _{LEAK}	1		0.02	1	0.2	nA	V _{OFF} =Load voltage ratings	
Capacitance between terminals	C _{OFF}	Typical	0.7	20	5	6.5	6	pF	V=0, f=100 MHz, t<1 s
		Maximum	1.3	-	7	11	8		
Capacitance between I/O terminals	C _{I-O}	1				pF	f=1 MHz, V _S =0 V		
Insulation resistance between I/O terminals	R _{I-O}	10 ⁸				MΩ	V _{I-O} =500 VDC, R _{oH} =60%		
Turn-ON time	t _{ON}	Typical	0.05	-		-		ms	I _F =5 mA, R _L =200 Ω, V _{DD} =20 V *
		Maximum	0.2	0.5		0.4			
Turn-OFF time	t _{OFF}	Typical	0.015	-		-		ms	I _F =5 mA, R _L =200 Ω, V _{DD} =20 V *
		Maximum	0.2	0.5		0.4			

* Turn-ON and Turn-OFF Times

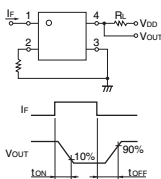

■ Recommended Operating Conditions

For usage with high reliability, Recommended Operation Conditions is a measure that takes into account the derating of Absolute Maximum Ratings and Electrical Characteristics.

Each item on this list is an independent condition, so it is not simultaneously satisfy several conditions.

Item	Symbol	G3VM-61UR1	G3VM-61UR	G3VM-81UR	G3VM-81UR1	G3VM-101UR	Unit
Load voltage (AC peak/DC)	V _{DD}	Maximum	48		64		V
		Minimum	5				
Operating LED forward current	I _F	Typical	7.5				mA
		Maximum	20				
		Minimum	-				
Continuous load current (AC peak/DC)	I _o	120	400	120	200	100	
Ambient operating temperature	Ta	Minimum	-20				°C
		Maximum	65				

G3VM-61UR□/81UR□/101UR

MOS FET Relays

Engineering Data

LED forward current vs. Ambient temperature

IF - Ta

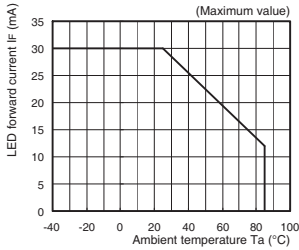

Continuous load current vs. Ambient temperature

Io - Ta

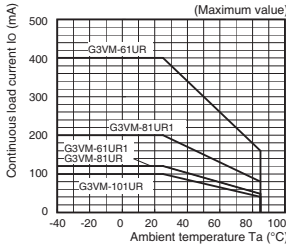

LED forward current vs. LED forward voltage

IF - Vf

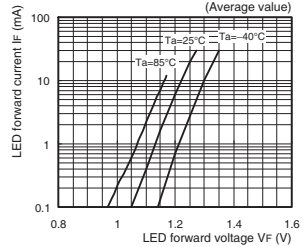

Continuous load current vs. On-state voltage

G3VM-61UR1/61UR

Io - VON

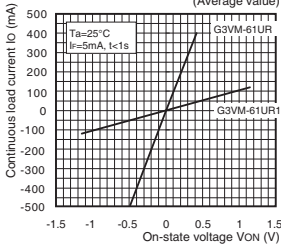

G3VM-81UR/81UR1/101UR

Io - VON

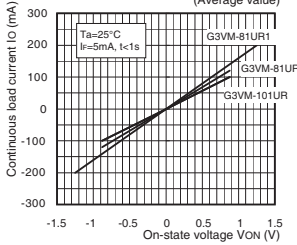

On-state resistance vs. Ambient temperature

RON - Ta

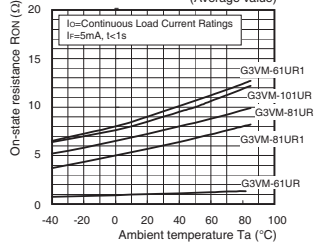

Trigger LED forward current vs. Ambient temperature

IFT - Ta

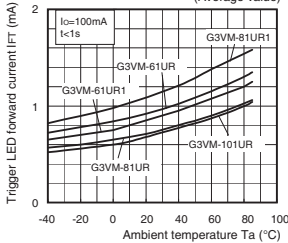

Turn ON, Turn OFF time vs. LED forward current

G3VM-61UR1/61UR

tON, tOFF - IF

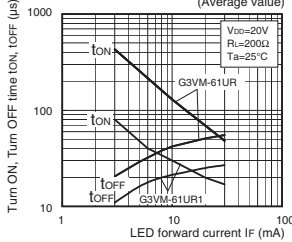

G3VM-81UR/81UR1/101UR

tON, tOFF - IF

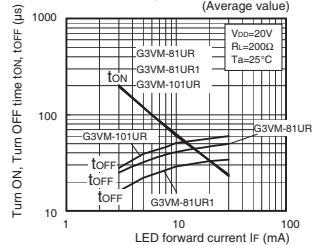

Introduction
 General purpose
 High-side voltage
 Multi-contact pair
 Low-VOL resistance
 High-current and
 inductive strength
 Small and high
 High-dielectric
 strength
 Current-limiting
 Low-voltage-resistance
 and low-on-resistance
 Small and High-
 Voltage
 Certified Models with
 Standards Derivation
 DIP
 SOP
 SSOP
 USOP
 VSON
 05S-S
 G3VM-61UR□/81UR□/101UR

G3VM-61UR□/81UR□/101UR

MOS FET Relays

Engineering Data

● Turn ON, Turn OFF time vs. Ambient temperature
G3VM-61UR1/61UR

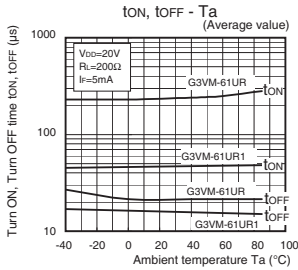

G3VM-81UR/81UR1/101UR

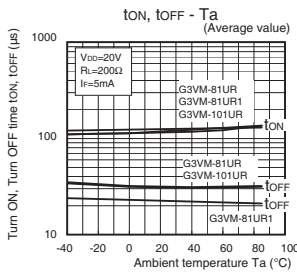

● Current leakage vs. Load voltage

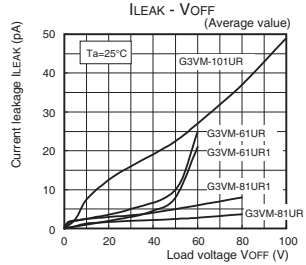

● Current leakage vs. Ambient temperature

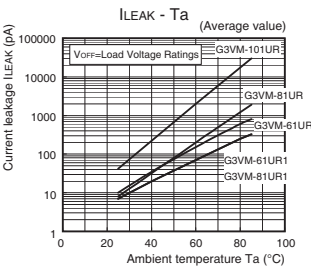

● Output terminal capacitance vs. Load voltage

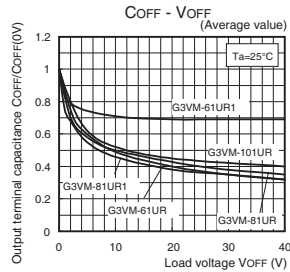

Introduction

General-purpose

High-load-voltage

Multi-contact type (2A, 2A, and 1A1)

High-current and Low-on-resistance

Small and high inductive strength

High-electric strength

Current-limiting

Low-voltage-capacitance and low-on-resistance

Small and High load-voltage

Certified models with Standard Certification

DIP

SOP

SSOP

USOP

VSON

S-VSON

G3VM-61UR□/81UR□/101UR

G3VM-61UR□/81UR□/101UR

MOS FET Relays

■ Appearance / Terminal Arrangement / Internal Connections

● Appearance

VSON (Very Small Outline Non-leaded)

VSON 4-pin

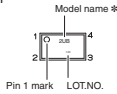

* Actual model name marking for each model

Model	Marking
G3VM-61UR1	6U1
G3VM-61UR	6U0
G3VM-81UR	8U0
G3VM-81UR1	8U1
G3VM-101UR	AU0

Note: 1. The actual product is marked differently from the image shown here.

Note: 2. "G3VM" does not appear in the model number on the Relay.

● Terminal Arrangement/Internal Connections (Top View)

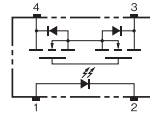

■ Dimensions (Unit: mm)

Surface-mounting Terminals

Weight: 0.01 g

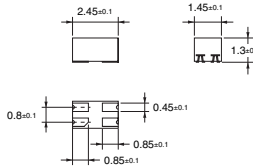
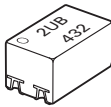

Actual Mounting Pad Dimensions

(Recommended Value, Top View)

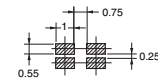
Unless otherwise specified, the dimensional tolerance is ± 0.1 mm.

Note: The actual product is marked differently from the image shown here.

■ Approved Standards

Applying for UL recognition

■ Safety Precautions

- Refer to the *Common Precautions for All MOS FET Relays* for precautions that apply to all MOS FET Relays.

Models with Standards Certification

July 2018

Consult your OMRON sales representative for specific models with standard approvals.

●MOS FET Relay DIP (Dual Inline Package)

Model	Standard	Contact	Standard No.	Coil ratings	Page
G3VM-21AR/DR	UL Approved Models (Recognized)	1a (SPST-NO)	E80555	3000 mA 20 V (AC peak/DC)	110
G3VM-21BR/ER	UL Approved Models (Recognized)	1a (SPST-NO)	E80555	4000 mA 20 V (AC peak/DC)	115
G3VM-41AY/DY	UL Approved Models (Recognized)	1a (SPST-NO)	E80555	2000 mA 40 V (AC peak/DC)	147
G3VM-41AY1/DY1	UL Approved Models (Recognized)	1a (SPST-NO)	E80555	2000 mA 40 V (AC peak/DC)	147
G3VM-41AR/DR	UL Approved Models (Recognized)	1a (SPST-NO)	E80555	2500 mA 40 V (AC peak/DC)	110
G3VM-41BR/ER	UL Approved Models (Recognized)	1a (SPST-NO)	E80555	3500 mA 40 V (AC peak/DC)	115
G3VM-61A1/D1	UL Approved Models (Recognized)	1a (SPST-NO)	E80555	500 mA 60 V (AC peak/DC)	62
G3VM-61AY/DY	UL Approved Models (Recognized)	1a (SPST-NO)	E80555	500 mA 60 V (AC peak/DC)	147
G3VM-61AY1/DY1	UL Approved Models (Recognized)	1a (SPST-NO)	E80555	500 mA 60 V (AC peak/DC)	147
G3VM-61AR/DR	UL Approved Models (Recognized)	1a (SPST-NO)	E80555	2000 mA 60 V (AC peak/DC)	110
G3VM-61B1/E1	UL Approved Models (Recognized)	1a (SPST-NO)	E80555	500 mA 60 V (AC peak/DC)	62
G3VM-61BR/ER	UL Approved Models (Recognized)	1a (SPST-NO)	E80555	2500 mA 60 V (AC peak/DC)	115
G3VM-61BR1/ER1	UL Approved Models (Recognized)	1a (SPST-NO)	E80555	3000 mA 60 V (AC peak/DC)	115
G3VM-61CR1/FR1	UL Approved Models (Recognized)	1a (SPST-NO)	E80555	500mA 60V (AC peak/DC)	121
G3VM-62C1/F1	UL Approved Models (Recognized)	2a (DPST-NO)	E80555	500 mA 60 V (AC peak/DC)	98
G3VM-101AR/DR	UL Approved Models (Recognized)	1a (SPST-NO)	E80555	1000 mA 100 V (AC peak/DC)	110
G3VM-101BR/ER	UL Approved Models (Recognized)	1a (SPST-NO)	E80555	2000 mA 100 V (AC peak/DC)	115
G3VM-101CR/FR	UL Approved Models (Recognized)	1a (SPST-NO)	E80555	3000mA 100V (AC peak/DC)	121
G3VM-201AY/DY	UL Approved Models (Recognized)	1a (SPST-NO)	E80555	250 mA 200 V (AC peak/DC)	147
G3VM-201AY1/DY1	UL Approved Models (Recognized)	1a (SPST-NO)	E80555	250 mA 200 V (AC peak/DC)	147
G3VM-201CR/FR	UL Approved Models (Recognized)	1a (SPST-NO)	E80555	1500mA 200V (AC peak/DC)	121
G3VM-351AY/DY	UL Approved Models (Recognized)	1a (SPST-NO)	E80555	100 mA 350 V (AC peak/DC)	147
G3VM-351AY1/DY1	UL Approved Models (Recognized)	1a (SPST-NO)	E80555	100 mA 350 V (AC peak/DC)	147
G3VM-2L2/FL	UL Approved Models (Recognized)	1a (SPST-NO)	E80555	120 mA 350 V (AC peak/DC)	159
G3VM-351A/D	UL Approved Models (Recognized)	1a (SPST-NO)	E80555	120 mA 350 V (AC peak/DC)	62
	EN62368-1 Approved Models (BSI certified)	1a (SPST-NO)	VC669156	---	
G3VM-353A/D	UL Approved Models (Recognized)	1b (SPST-NC)	E80555	150 mA 350 V (AC peak/DC)	62
G3VM-351B/E	UL Approved Models (Recognized)	1a (SPST-NO)	E80555	120 mA 350 V (AC peak/DC)	62
G3VM-353B/E	UL Approved Models (Recognized)	1b (SPST-NC)	E80555	150 mA 350 V (AC peak/DC)	62
G3VM-352C/F	UL Approved Models (Recognized)	2a (DPST-NO)	E80555	120 mA 350 V (AC peak/DC)	98
	EN62368-1 Approved Models (BSI certified)	2a (DPST-NO)	VC669156	---	
G3VM-WLWFL	UL Approved Models (Recognized)	2a (DPST-NO)	E80555	120 mA 350 V (AC peak/DC)	159
G3VM-354C/F	UL Approved Models (Recognized)	2b (DPST-NC)	E80555	150 mA 350 V (AC peak/DC)	98
G3VM-401A/D	UL Approved Models (Recognized)	1a (SPST-NO)	E80555	120 mA 400 V (AC peak/DC)	62
G3VM-401AY/DY	UL Approved Models (Recognized)	1a (SPST-NO)	E80555	120 mA 400 V (AC peak/DC)	147
G3VM-401AY1/DY1	UL Approved Models (Recognized)	1a (SPST-NO)	E80555	120 mA 400 V (AC peak/DC)	147
G3VM-401B/E	UL Approved Models (Recognized)	1a (SPST-NO)	E80555	120 mA 400 V (AC peak/DC)	62
G3VM-401BY/EY	UL Approved Models (Recognized)	1a (SPST-NO)	E80555	120 mA 400 V (AC peak/DC)	155
G3VM-401CR/FR	UL Approved Models (Recognized)	1a (SPST-NO)	E80555	400mA 400V (AC peak/DC)	121
G3VM-402C/F	UL Approved Models (Recognized)	2a (DPST-NO)	E80555	120 mA 400 V (AC peak/DC)	98
G3VM-601AY/DY	UL Approved Models (Recognized)	1a (SPST-NO)	E80555	90 mA 600 V (AC peak/DC)	147
G3VM-601AY1/DY1	UL Approved Models (Recognized)	1a (SPST-NO)	E80555	90 mA 600 V (AC peak/DC)	147
G3VM-601BY/EY	UL Approved Models (Recognized)	1a (SPST-NO)	E80555	100 mA 600 V (AC peak/DC)	155
G3VM-601CR/FR	UL Approved Models (Recognized)	1a (SPST-NO)	E80555	600mA 600V (AC peak/DC)	121

Models with Standards Certification

July 2018

Consult your OMRON sales representative for specific models with standard approvals.

SOP (Small Outline Package)

Model	Standard	Contact	Standard No.	Coil ratings	Page
G3VM-21GR	UL Approved Models (Recognized)	1a (SPST-NO)	E80555	160 mA 20 V (AC peak/DC)	165
G3VM-21GR1	UL Approved Models (Recognized)	1a (SPST-NO)	E80555	300 mA 20 V (AC peak/DC)	165
G3VM-21HR	UL Approved Models (Recognized)	1a (SPST-NO)	E80555	2500 mA 20 V (AC peak/DC)	131
G3VM-31HR	UL Approved Models (Recognized)	1a (SPST-NO)	E80555	4000mA 30V (AC peak/DC)	131
G3VM-41GR6	UL Approved Models (Recognized)	1a (SPST-NO)	E80555	120 mA 40 V (AC peak/DC)	165
G3VM-41GR4	UL Approved Models (Recognized)	1a (SPST-NO)	E80555	250 mA 40 V (AC peak/DC)	165
G3VM-41GR5	UL Approved Models (Recognized)	1a (SPST-NO)	E80555	300 mA 40 V (AC peak/DC)	165
G3VM-41GR8	UL Approved Models (Recognized)	1a (SPST-NO)	E80555	1000 mA 40 V (AC peak/DC)	127
G3VM-41HR	UL Approved Models (Recognized)	1a (SPST-NO)	E80555	2500 mA 40 V (AC peak/DC)	131
G3VM-61VY1	UL Approved Models (Recognized)	1a (SPST-NO)	E80555	100 mA 60 V (AC peak/DC)	68
G3VM-61G1	UL Approved Models (Recognized)	1a (SPST-NO)	E80555	400 mA 60 V (AC peak/DC)	68
G3VM-61G2	UL Approved Models (Recognized)	1a (SPST-NO)	E80555	400 mA 60 V (AC peak/DC)	68
G3VM-61G3	UL Approved Models (Recognized)	1a (SPST-NO)	E80555	400 mA 60 V (AC peak/DC)	68
G3VM-61VY2	UL Approved Models (Recognized)	1a (SPST-NO)	E80555	500mA 60V (AC peak/DC)	68
G3VM-61VY3	UL Approved Models (Recognized)	1a (SPST-NO)	E80555	700mA 60V (AC peak/DC)	68
G3VM-61GR1	UL Approved Models (Recognized)	1a (SPST-NO)	E80555	1000 mA 60 V (AC peak/DC)	127
G3VM-61GR2	UL Approved Models (Recognized)	1a (SPST-NO)	E80555	1700mA 60V (AC peak/DC)	127
G3VM-61VR	UL Approved Models (Recognized)	1a (SPST-NO)	E80555	1400mA 60V (AC peak/DC)	127
G3VM-63G	UL Approved Models (Recognized)	1b (SPST-NC)	E80555	500mA 60V (AC peak/DC)	68
G3VM-61H1	UL Approved Models (Recognized)	1a (SPST-NO)	E80555	400 mA 60 V (AC peak/DC)	88
G3VM-61HR	UL Approved Models (Recognized)	1a (SPST-NO)	E80555	2300 mA 60 V (AC peak/DC)	131
G3VM-61HR1	UL Approved Models (Recognized)	1a (SPST-NO)	E80555	3300mA 60V (AC peak/DC)	131
G3VM-62J1	UL Approved Models (Recognized)	2a (DPST-NO)	E80555	400 mA 60 V (AC peak/DC)	104
G3VM-81GR	UL Approved Models (Recognized)	1a (SPST-NO)	E80555	40 mA 80 V (AC peak/DC)	165
G3VM-81GR1	UL Approved Models (Recognized)	1a (SPST-NO)	E80555	200 mA 80 V (AC peak/DC)	165
G3VM-81G1	UL Approved Models (Recognized)	1a (SPST-NO)	E80555	350 mA 80 V (AC peak/DC)	73
G3VM-81HR	UL Approved Models (Recognized)	1a (SPST-NO)	E80555	1250 mA 80 V (AC peak/DC)	137
G3VM-101HR	UL Approved Models (Recognized)	1a (SPST-NO)	E80555	1400 mA 100 V (AC peak/DC)	137
G3VM-101HR1	UL Approved Models (Recognized)	1a (SPST-NO)	E80555	2000mA 100V (AC peak/DC)	137
G3VM-201G	UL Approved Models (Recognized)	1a (SPST-NO)	E80555	50 mA 200 V (AC peak/DC)	77
G3VM-201G1	UL Approved Models (Recognized)	1a (SPST-NO)	E80555	200 mA 200 V (AC peak/DC)	77
G3VM-201G2	UL Approved Models (Recognized)	1a (SPST-NO)	E80555	200 mA 200 V (AC peak/DC)	77
G3VM-S5	UL Approved Models (Recognized)	1a (SPST-NO)	E80555	200 mA 200 V (AC peak/DC)	77
G3VM-201H1	UL Approved Models (Recognized)	1a (SPST-NO)	E80555	200 mA 200 V (AC peak/DC)	88
G3VM-202J1	UL Approved Models (Recognized)	2a (DPST-NO)	E80555	200 mA 200 V (AC peak/DC)	104
G3VM-351G1	UL Approved Models (Recognized)	1a (SPST-NO)	E80555	100 mA 350 V (AC peak/DC)	82
G3VM-351G	UL Approved Models (Recognized)	1a (SPST-NO)	E80555	110 mA 350 V (AC peak/DC)	82
G3VM-351VY	UL Approved Models (Recognized)	1a (SPST-NO)	E80555	110mA 350V (AC peak/DC)	82
G3VM-353G	UL Approved Models (Recognized)	1b (SPST-NC)	E80555	120 mA 350 V (AC peak/DC)	82
G3VM-351H	UL Approved Models (Recognized)	1a (SPST-NO)	E80555	110 mA 350 V (AC peak/DC)	88
G3VM-353H	UL Approved Models (Recognized)	1b (SPST-NO)	E80555	120 mA 350 V (AC peak/DC)	88
G3VM-355JR	UL Approved Models (Recognized)	1a1b (SPST-NO/SPST-NC)	E80555	120 mA 350 V (AC peak/DC)	104
G3VM-352J	UL Approved Models (Recognized)	2a (DPST-NO)	E80555	110 mA 350 V (AC peak/DC)	104
G3VM-354J	UL Approved Models (Recognized)	2b (DPST-NC)	E80555	120 mA 350 V (AC peak/DC)	104
G3VM-401G1	UL certification pending.	1a (SPST-NO)	E80555	100 mA 400 V (AC peak/DC)	82
G3VM-401G	UL Approved Models (Recognized)	1a (SPST-NO)	E80555	120 mA 400 V (AC peak/DC)	82
	EN62368-1 Approved Models (BSI certified)	1a (SPST-NO)	VC669262	---	
G3VM-401H	UL Approved Models (Recognized)	1a (SPST-NO)	E80555	120 mA 400 V (AC peak/DC)	88
	EN62368-1 Approved Models (BSI certified)	1a (SPST-NO)	VC669262	---	
G3VM-402J	UL Approved Models (Recognized)	2a (DPST-NO)	E80555	120 mA 400 V (AC peak/DC)	104
	EN62368-1 Approved Models (BSI certified)	2a (DPST-NO)	VC669262	---	
G3VM-601G1	UL Approved Models (Recognized)	1a (SPST-NO)	E80555	70 mA 600 V (AC peak/DC)	94
G3VM-601G	UL Approved Models (Recognized)	1a (SPST-NO)	E80555	90 mA 600 V (AC peak/DC)	94

Models with Standards Certification

July 2018

Consult your OMRON sales representative for specific models with standard approvals.

SSOP (Shrink Small Outline Package)

Model	Standard	Contact	Standard No.	Coil ratings	Page
G3VM-21LR	UL Approved Models (Recognized)	1a (SPST-NO)	E80555	160 mA 20 V (AC peak/DC)	170
G3VM-21LR10	UL Approved Models (Recognized)	1a (SPST-NO)	E80555	200 mA 20 V (AC peak/DC)	170
G3VM-21LR1	UL Approved Models (Recognized)	1a (SPST-NO)	E80555	450 mA 20 V (AC peak/DC)	170
G3VM-21LR11	UL Approved Models (Recognized)	1a (SPST-NO)	E80555	900 mA 20 V (AC peak/DC)	170
G3VM-41LR10	UL Approved Models (Recognized)	1a (SPST-NO)	E80555	120 mA 40 V (AC peak/DC)	175
G3VM-41LR6	UL Approved Models (Recognized)	1a (SPST-NO)	E80555	120 mA 40 V (AC peak/DC)	175
G3VM-41LR11	UL Approved Models (Recognized)	1a (SPST-NO)	E80555	140 mA 40 V (AC peak/DC)	175
G3VM-41LR4	UL Approved Models (Recognized)	1a (SPST-NO)	E80555	250 mA 40 V (AC peak/DC)	175
G3VM-41LR5	UL Approved Models (Recognized)	1a (SPST-NO)	E80555	300 mA 40 V (AC peak/DC)	175
G3VM-61LR	UL Approved Models (Recognized)	1a (SPST-NO)	E80555	400 mA 60 V (AC peak/DC)	204
G3VM-81LR	UL Approved Models (Recognized)	1a (SPST-NO)	E80555	120 mA 80 V (AC peak/DC)	204
G3VM-101LR	UL Approved Models (Recognized)	1a (SPST-NO)	E80555	80 mA 100 V (AC peak/DC)	204

USOP (Ultra Small Outline Package)

Model	Standard	Contact	Standard No.	Coil ratings	Page
G3VM-21PR10	UL Approved Models (Recognized)	1a (SPST-NO)	E80555	200 mA 20 V (AC peak/DC)	180
G3VM-21PR1	UL Approved Models (Recognized)	1a (SPST-NO)	E80555	450 mA 20 V (AC peak/DC)	180
G3VM-21PR11	UL Approved Models (Recognized)	1a (SPST-NO)	E80555	900 mA 20 V (AC peak/DC)	180
G3VM-41PR12	UL Approved Models (Recognized)	1a (SPST-NO)	E80555	100 mA 40 V (AC peak/DC)	185
G3VM-41PR10	UL Approved Models (Recognized)	1a (SPST-NO)	E80555	120 mA 40 V (AC peak/DC)	185
G3VM-41PR6	UL Approved Models (Recognized)	1a (SPST-NO)	E80555	120 mA 40 V (AC peak/DC)	185
G3VM-41PR11	UL Approved Models (Recognized)	1a (SPST-NO)	E80555	140 mA 40 V (AC peak/DC)	185
G3VM-41PR5	UL Approved Models (Recognized)	1a (SPST-NO)	E80555	300 mA 40 V (AC peak/DC)	185
G3VM-51PR	UL Approved Models (Recognized)	1a (SPST-NO)	E80555	300 mA 50 V (AC peak/DC)	185
G3VM-61PR1	UL Approved Models (Recognized)	1a (SPST-NO)	E80555	120 mA 60 V (AC peak/DC)	208
G3VM-61PR	UL Approved Models (Recognized)	1a (SPST-NO)	E80555	400 mA 60 V (AC peak/DC)	208
G3VM-71PR	UL Approved Models (Recognized)	1a (SPST-NO)	E80555	400 mA 75 V (AC peak/DC)	208
G3VM-81PR	UL Approved Models (Recognized)	1a (SPST-NO)	E80555	120 mA 80 V (AC peak/DC)	208
G3VM-101PR	UL Approved Models (Recognized)	1a (SPST-NO)	E80555	100 mA 100 V (AC peak/DC)	208

VSON (Very Small Outline Non-leaded)

Model	Standard	Contact	Standard No.	Coil ratings	Page
G3VM-21UR10	UL certification pending.	1a (SPST-NO)	E80555	200 mA 20 V (AC peak/DC)	190
G3VM-21UR1	UL certification pending.	1a (SPST-NO)	E80555	450 mA 20 V (AC peak/DC)	190
G3VM-21UR11	UL certification pending.	1a (SPST-NO)	E80555	1000 mA 20 V (AC peak/DC)	190
G3VM-41UR12	UL certification pending.	1a (SPST-NO)	E80555	100 mA 40 V (AC peak/DC)	195
G3VM-41UR10	UL certification pending.	1a (SPST-NO)	E80555	120 mA 40 V (AC peak/DC)	195
G3VM-41UR11	UL certification pending.	1a (SPST-NO)	E80555	140 mA 40 V (AC peak/DC)	195
G3VM-51UR	UL certification pending.	1a (SPST-NO)	E80555	300 mA 50 V (AC peak/DC)	195
G3VM-61UR1	UL certification pending.	1a (SPST-NO)	E80555	120 mA 60 V (AC peak/DC)	213
G3VM-61UR	UL certification pending.	1a (SPST-NO)	E80555	400 mA 60 V (AC peak/DC)	213
G3VM-81UR	UL certification pending.	1a (SPST-NO)	E80555	120 mA 80 V (AC peak/DC)	213
G3VM-81UR1	UL certification pending.	1a (SPST-NO)	E80555	200 mA 80 V (AC peak/DC)	213
G3VM-101UR	UL certification pending.	1a (SPST-NO)	E80555	100 mA 100 V (AC peak/DC)	213

A Selection Guide is available in addition to this MOS FET Relay General Catalog.

- The Selection Guide allows you to easily search for products using tables of basic specifications.
- You can use simple searches in the Selection Guide and then check for details in this General Catalog.
- Basic information is summarized in the booklet so that you can easily take the Selection Guide with you wherever you might need it.

Let us know how we can help you.

Please check each region's Terms & Conditions by region website.

OMRON Corporation Electronic and Mechanical Components Company

Regional Contact

Americas

<https://www.components.omron.com/>

Asia-Pacific

<https://ecb.omron.com.sg/>

Korea

<https://www.omron-ecb.co.kr/>

Europe

<http://components.omron.eu/>

China

<https://www.ecb.omron.com.cn/>

Japan

<https://www.omron.co.jp/ecb/>

OUR CERTIFICATE

DiGi provide top-quality products and perfect service for customer worldwide through standardization, technological innovation and continuous improvement. DiGi through third-party certification, we stricly control the quality of products and services. Welcome your RFQ to

Email: Info@DiGi-Electronics.com



Tel: +00  857-30501935

RFQ Email: Info@DiGi-Electronics.com

DiGi is a global authorized distributor of electronic components.