

EDZ951/5 Datasheet

www.digi-electronics.com



<https://www.DiGi-Electronics.com>

DiGi Electronics Part Number	EDZ951/5-DG
Manufacturer	On Shore Technology Inc.
Manufacturer Product Number	EDZ951/5
Description	TERM BLOCK PLUG 5POS STR 5.08MM
Detailed Description	5 Position Terminal Block Plug, Female Sockets 0.200" (5.08mm) Free Hanging (In-Line)

This model EDZ951/5 is available at DiGi Electronics.

DiGi Electronics offers a global database of semiconductor and electronic component datasheets.

We welcome your inquiries regarding pricing, lead time, or other product-related questions.

 [Request a Quote](#)

 [Datasheet Search](#)



Tel: +00 852-30501935

RFQ Email: Info@DiGi-Electronics.com

DiGi is a global authorized distributor of electronic components.

Purchase and inquiry

Manufacturer Product Number:

EDZ951/5

Series:

EDZ951

Type:

Plug, Female Sockets

Positions Per Level:

5

Pitch:

0.200" (5.08mm)

Plug Wire Entry:

-

Mounting Type:

Free Hanging (In-Line)

Voltage - UL:

300 V

Wire Gauge or Range - mm²:

2.5mm²

Operating Temperature:

-30°C ~ 105°C

Features:

-

Ingress Protection:

-

Torque - Screw:

0.5 Nm (4.4 Lb-In)

Contact Material:

Copper

Contact Tail Length:

-

Base Product Number:

EDZ951

Manufacturer:

On Shore Technology Inc.

Product Status:

Active

Number of Positions:

5

Number of Levels:

1

Header Orientation:

-

Termination Style:

Screw

Current - IEC:

-

Wire Gauge or Range - AWG:

12-22 AWG

Color:

Green

Contact Mating Finish:

-

Material Flammability Rating:

UL94 V-0

Screw Size:

-

Wire Strip Length:

6mm

Housing Material:

Polyamide (PA), Nylon

Insulation Height:

-

Environmental & Export classification

RoHS Status:

ROHS3 Compliant

REACH Status:

REACH Compliant

Moisture Sensitivity Level (MSL):

Unlimited

ECCN:

EAR99

ED951/X (5.0 mm) EDZ951/X (5.08 mm)

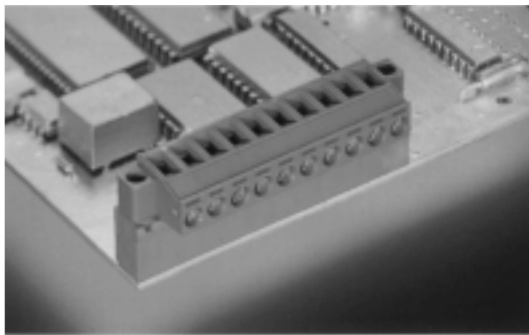

2-10 poles, Spacing 5.0 mm or 5.08 mm
insert required no. of poles \times
How to order see page 5



Ratings:

Rated Voltage	300 V	250 V
Rated Current	15 A	12 A (T60)
Wire Size	AWG 22-12	2.5 mm ²
Test Voltage		4 kV/3
Rated Torque/ScrewSize		0.5 Nm/M3

Max. Rated Cross Section

Single Wire (solid)	2.5 mm ²
Stranded Wire (flexible)	2.5 mm ²
Stranded wire with Ferrules	2.5 mm ²

Dimensions

Spacing	5.0 mm (5.08 mm)
Stripped Length	6.0 mm

Materials

Insulating Material	PA
Flammability Class	UL94 V-0
Temperature Range	-30°C/+105°C
Terminal Block	CuZn
Contact	CuSn

Color

Green

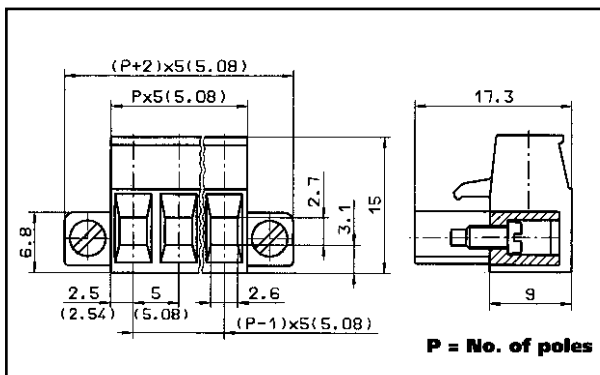

OUR CERTIFICATE

DiGi provide top-quality products and perfect service for customer worldwide through standardization, technological innovation and continuous improvement. DiGi through third-party certification, we stricly control the quality of products and services. Welcome your RFQ to

Email: Info@DiGi-Electronics.com



Tel: +00 852-30501935

RFQ Email: Info@DiGi-Electronics.com

DiGi is a global authorized distributor of electronic components.