

AIAP-01-5R6K-T Datasheet



<https://www.DiGi-Electronics.com>

DiGi Electronics Part Number	AIAP-01-5R6K-T-DG
Manufacturer	Abracon LLC
Manufacturer Product Number	AIAP-01-5R6K-T
Description	FIXED IND 5.6UH 1.6A 74 MOHM TH
Detailed Description	5.6 μ H Unshielded Wirewound Inductor 1.6 A 74mOhm Max Axial



Tel: +00 852-30501935

RFQ Email: Info@DiGi-Electronics.com

DiGi is a global authorized distributor of electronic components.

Purchase and inquiry

Manufacturer Product Number:

AIAP-01-5R6K-T

Series:

AIAP-01

Type:

Wirewound

Inductance:

5.6 μ H

Current Rating (Amps):

1.6 A

Shielding:

Unshielded

Q @ Freq:

-

Ratings:

-

Inductance Frequency - Test:

7.9 MHz

Package / Case:

Axial

Size / Dimension:

0.130" Dia x 0.360" L (3.30mm x 9.14mm)

Manufacturer:

Abracon LLC

Product Status:

Active

Material - Core:

-

Tolerance:

\pm 10%

Current - Saturation (Isat):

-

DC Resistance (DCR):

74mOhm Max

Frequency - Self Resonant:

64MHz

Operating Temperature:

-40°C ~ 105°C

Mounting Type:

Through Hole

Supplier Device Package:

-

Height - Seated (Max):

-

Environmental & Export classification

RoHS Status:

ROHS3 Compliant

REACH Status:

REACH Unaffected

HTSUS:

8504.50.8000

Moisture Sensitivity Level (MSL):

1 (Unlimited)

ECCN:

EAR99

Epoxy Coated Inductor



AIAP-01

Request Samples



Check Inventory



9.14 x ϕ 3.9mm
 10.70 x ϕ 4.6mm
RoHS/RoHS II Compliant
 MSL Level = 1

Features

- Low-cost axial leaded inductors
- High current rating
- Wide inductance range.

Applications

- Power Supplies
- Switching circuits
- TV and audio equipment
- Telecommunication devices
- RF and other filters

Electrical Specifications

Part Number	Inductance	Tolerance	DC Resistance	Self Resonant Frequency	Rated Current	Inductance Code	Dimensions
	0.1MHz/1.0V		Max	Min.	Typ.		(refer to mechanical section)
Units	μ H	%	Ω	MHz	mA		
Symbol	L	M	DCR	SRF	Idc		
AIAP-01-1R0	1.0	K	0.030	190	3300	1R0	A
AIAP-01-1R2	1.2	K	0.019	170	3200	1R2	A
AIAP-01-1R5	1.5	K	0.020	160	3100	1R5	A
AIAP-01-1R8	1.8	K	0.023	150	2900	1R8	A
AIAP-01-2R2	2.2	K	0.031	130	2600	2R2	A
AIAP-01-2R7	2.7	K	0.033	120	2500	2R7	A
AIAP-01-3R3	3.3	K	0.054	110	1900	3R3	A
AIAP-01-3R9	3.9	K	0.060	100	1800	3R9	A
AIAP-01-4R7	4.7	K	0.068	86	1700	4R7	A
AIAP-01-5R6	5.6	K	0.074	64	1600	5R6	A
AIAP-01-6R8	6.8	K	0.080	44	1600	6R8	A
AIAP-01-8R2	8.2	K	0.087	32	1500	8R2	A
AIAP-01-100	10	K	0.095	25	1500	100	A
AIAP-01-120	12	K	0.11	17	1400	120	A
AIAP-01-150	15	K	0.15	13	1200	150	A
AIAP-01-180	18	K	0.16	10	1100	180	A
AIAP-01-220	22	K	0.19	8.4	1000	220	A
AIAP-01-270	27	K	0.22	8.0	950	270	A
AIAP-01-330	33	K	0.29	7.6	910	330	A
AIAP-01-390	39	K	0.26	7.1	880	390	A
AIAP-01-470	47	K	0.35	6.0	760	470	A
AIAP-01-560	56	K	0.47	5.8	650	560	A
AIAP-01-680	68	K	0.53	4.3	610	680	A
AIAP-01-820	82	K	0.60	4.1	580	820	A
AIAP-01-101	100	K	0.67	3.9	550	101	A



5101 Hidden Creek Ln, Spicewood TX 78669
 Phone: 512-371-6159 Fax: 512-351-8858
 For terms and conditions of sales, please visit:
www.abracon.com

REVISION I: 7/2/2024

ABRACON IS
 ISO9001-2015
 CERTIFIED

Epoxy Coated Inductor



AIAP-01

Request Samples



Check Inventory



9.14 x ϕ 3.9mm
10.70 x ϕ 4.6mm
RoHS/RoHS II Compliant
MSL Level = 1

Part Number Identification

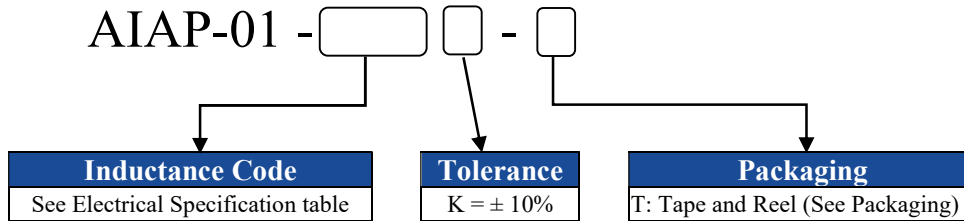

Marking

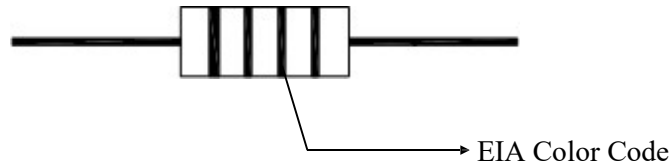

Mechanical Specifications

Part Dimensions: A

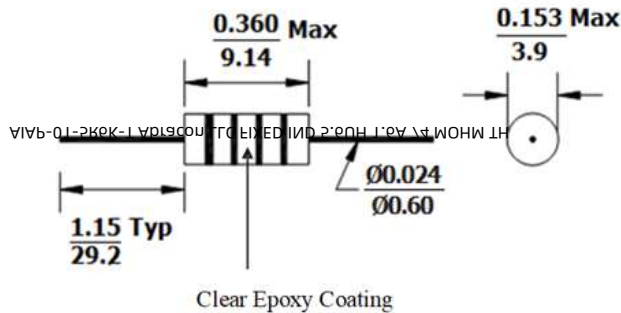

Dimensions: Inches / mm



5101 Hidden Creek Ln, Spicewood TX 78669
Phone: 512-371-6159 Fax: 512-351-8858
For terms and conditions of sales, please visit:
www.abracon.com

REVISION I: 7/2/2024

ABRACON IS
ISO9001-2015
CERTIFIED

Epoxy Coated Inductor



AIAP-01

Request Samples



Check Inventory



9.14 x ϕ 3.9mm
10.70 x ϕ 4.6mm
RoHS/RoHS II Compliant
MSL Level = 1

Part Dimensions: B

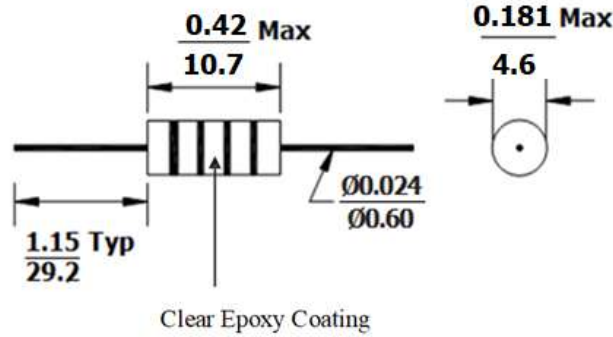

Dimensions: Inches / mm

Wave Soldering Profile

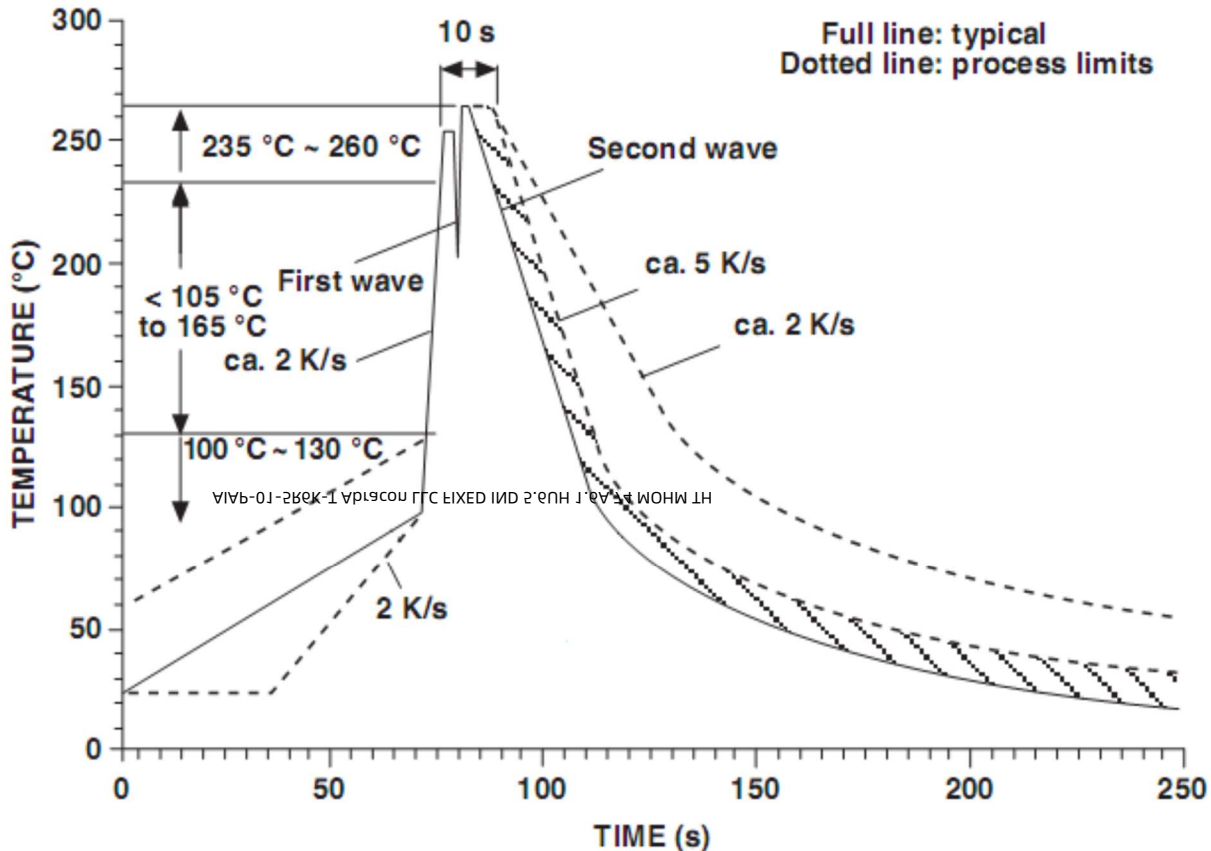

5101 Hidden Creek Ln, Spicewood TX 78669
Phone: 512-371-6159 Fax: 512-351-8858
For terms and conditions of sales, please visit:
www.abracon.com

REVISION I: 7/2/2024

ABRACON IS
ISO9001-2015
CERTIFIED

Epoxy Coated Inductor



AIAP-01

Request Samples



Check Inventory



9.14 x ϕ 3.9mm

10.70 x ϕ 4.6mm

RoHS/RoHS II Compliant

MSL Level = 1

Packaging

Tape & Reel: 2,500 pcs/reel

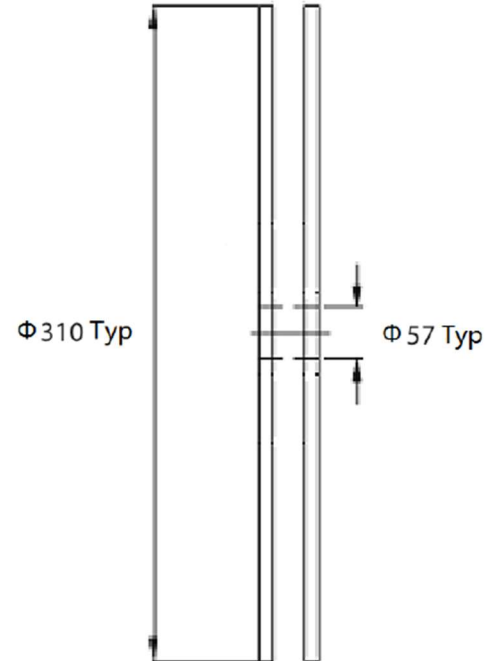
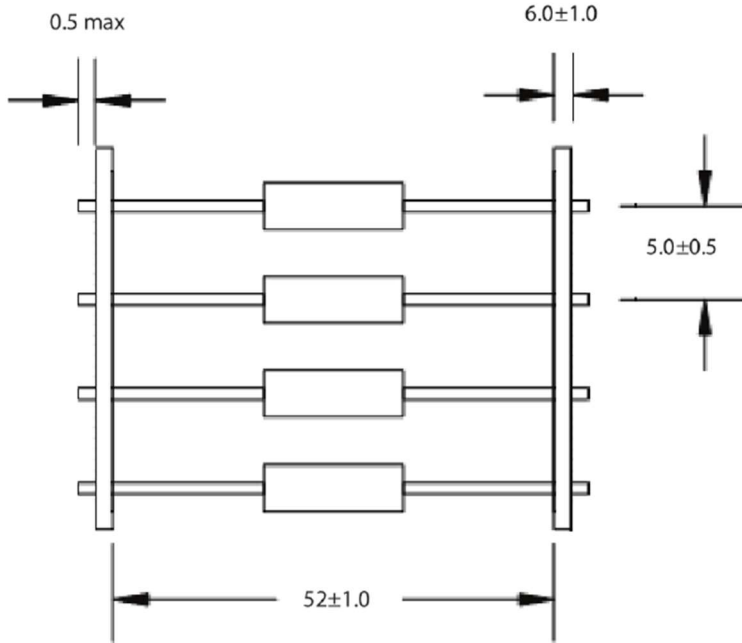

Dimensions: mm

HT MHOM R7 Aa, J HUa, 2 QH IHD 2 LLC noda1da T-KaR2-T-0-9AA

ATTENTION: Abracon LLC's products are Commercial-Off-The-Shelf (COTS, which are designed, intended and validated for use in commercial, industrial and automotive applications. The customer is responsible for testing and verifying the performance of an Abracon solution to meet their system-level requirements.



5101 Hidden Creek Ln, Spicewood TX 78669
Phone: 512-371-6159 Fax: 512-351-8858
For terms and conditions of sales, please visit:
www.abracon.com

REVISION 1: 7/2/2024

ABRACON IS
ISO9001-2015
CERTIFIED

OUR CERTIFICATE

DiGi provide top-quality products and perfect service for customer worldwide through standardization, technological innovation and continuous improvement. DiGi through third-party certification, we stricly control the quality of products and services. Welcome your RFQ to

Email: Info@DiGi-Electronics.com



Tel: +00 852-30501935

RFQ Email: Info@DiGi-Electronics.com

DiGi is a global authorized distributor of electronic components.