

ARJ11B-MASAC-MU2 Datasheet

www.digi-electronics.com



<https://www.DiGi-Electronics.com>

| | |
|------------------------------|---|
| DiGi Electronics Part Number | ARJ11B-MASAC-MU2-DG |
| Manufacturer | Abracon LLC |
| Manufacturer Product Number | ARJ11B-MASAC-MU2 |
| Description | CONN JACK 1PORT 100 BASE-T PCB |
| Detailed Description | 1 Port RJ45Through Hole 10/100 Base-T, AutoMDIX |

This model ARJ11B-MASAC-MU2 is available at DiGi Electronics.

DiGi Electronics offers a global database of semiconductor and electronic component datasheets.

We welcome your inquiries regarding pricing, lead time, or other product-related questions.

 [Request a Quote](#)

 [Datasheet Search](#)



Tel: +00 852-30501935

RFQ Email: Info@DiGi-Electronics.com

DiGi is a global authorized distributor of electronic components.

Purchase and inquiry

Manufacturer Product Number:

ARJ11B-MASAC-MU2

Series:

ARJ11B

Connector Type:

RJ45

Number of Rows:

1

Mounting Type:

Through Hole

Termination:

Solder

LED Color:

Does Not Contain LED

Shielding:

Shielded, EMI Finger

Tab Direction:

Down

Contact Finish:

Gold

Contact Finish Thickness:

6.00µin (0.152µm)

Housing Material:

-

Manufacturer:

Abracon LLC

Product Status:

Active

Number of Ports:

1

Applications:

10/100 Base-T, AutoMDIX

Orientation:

90° Angle (Right)

Height Above Board:

0.545" (13.84mm)

Number of Cores per Jack:

4

Features:

Board Lock

Contact Material:

-

Operating Temperature:

0°C ~ 70°C

Shield Material:

-

Environmental & Export classification

RoHS Status:

ROHS3 Compliant

REACH Status:

REACH Unaffected

HTSUS:

8536.69.4040

Moisture Sensitivity Level (MSL):

1 (Unlimited)

ECCN:

EAR99

RJ45 10/100 Base-T Jack with Magnetic Module

ARJ11B-MASAC-MU2 Abracon LLC CONN JACK 1PORT 100 BASE-T PCB



16.26 x 13.84 x 21.59mm

ARJ11B

RoHS
Compliant

FEATURES:

- Excellent EMI suppression
- Meet IEEE 802.3 standards and FCC mechanical requirements
- Low Cost, RoHS Compliant Reflow-able device

APPLICATIONS:

- LAN-on-Motherboard (LOM)
- SOHO (ADSL modems), Hubs.
- Suitable for CAT 5 & 6 Fast Ethernet Cable or better UTP

STANDARD SPECIFICATIONS:

Operating Temperature: - 0°C to + 70°C
Storage Temperature: - 40°C to +85°C

| Part Number | Turns Ratio ±5% | | EMI Fingers | LED (L/R) | Insertion Loss (dB max) |
|--|-----------------|------------|-------------|-----------|-------------------------|
| | TX | RX | | | 0.3-100 MHz |
| ARJ11B-MASAA-MU2 to ARJ11B-MASAI-MU2 | 1CT:1CT | 1CT:1CT | YES | --- | -1 |
| ARJ11B-MASAJ-MU2 to ARJ11B-MASAM-MU2 | 1CT:1CT | 1CT:1CT | YES | --- | -1 |
| ARJ11B-MASAN-LU2 to ARJ11B-MASBF-LU2 | 1CT:1 | 1CT:1CT | YES | --- | -1 |
| ARJ11B-MESCB-A-B-ELT2 | 1CT:1 | 1CT:1 | NO | G/Y | -1 |
| ARJ11B-MASCB-LT2 | 1CT:1 | 1CT:1 | YES | --- | -1 |
| ARJ11B-MBSCB-A-B-ELT2 | 1CT:1 | 1CT:1 | YES | G/Y | -1 |
| ARJ11B-MDSBQ-MU2 | 1CT:1CT | 1CT:1CT | NO | --- | -1 |
| ARJ11B-MESBQ-A-B-EMU2 | 1CT:1CT | 1CT:1CT | NO | G/Y | -1 |
| ARJ11B-MASBQ-MU2 | 1CT:1CT | 1CT:1CT | YES | --- | -1 |
| ARJ11B-MBSBQ-A-B-EMU2 | 1CT:1CT | 1CT:1CT | YES | G/Y | -1 |
| ARJ11B-MFSBQ-A-A-EMU2 | 1CT:1CT | 1CT:1CT | YES | G/G | -1 |
| ARJ11B-MASAJ-MU2 | 1CT:1CT | 1CT:1CT | YES | --- | -1 |
| ARJ11B-MASBR-QU2 | 1CT:1.414CT | 1CT:1CT | YES | --- | -1 |
| ARJ11B-MFSBR-A-A-EQU2 | 1CT:1.414CT | 1CT:1CT | YES | G/G | -1 |
| ARJ11B-MDSAO-LU2 | 1CT:1 | 1CT:1CT | NO | --- | -1 |
| ARJ11B-MESAO-A-B-ELU2 | 1CT:1 | 1CT:1CT | NO | G/Y | -1 |
| ARJ11B-MESAO-A-A-ELU2 | 1CT:1 | 1CT:1CT | NO | G/G | -1 |
| ARJ11B-MASAO-LU2 | 1CT:1 | 1CT:1CT | YES | --- | -1 |
| ARJ11B-MBSAO-A-B-ELU2 | 1CT:1 | 1CT:1CT | YES | G/Y | -1 |
| ARJ11B-MFSAO-A-A-ELU2 | 1CT:1 | 1CT:1CT | YES | G/G | -1 |
| ARJ11B-MFSAO-BA-A-GLU2 | 1CT:1 | 1CT:1CT | YES | YG/G | -1 |
| ARJ11B-MBSAP-A-B-ELU2 | 1CT:1 | 1CT:1CT | YES | G/Y | -1 |
| ARJ11B-MASAC-MU2 | 1CT:1CT | 1CT:1CT | YES | --- | -1 |
| ARJ11B-MASAD-OW2 | 1CT:1.41CT | 1CT:1.41CT | YES | --- | --- |
| ARJ11B-MBSAI-A-B-EMU2 | 1CT:1CT | 1CT:1CT | YES | G/Y | -1 |
| ARJ11B-MASCC-MU2 | 1CT:1CT | 1CT:1CT | YES | --- | -1 |
| ARJ11B-MESBW-B-A-EMU2 | 1CT:1CT | 1CT:1CT | NO | Y/G | -1 |



RJ45 10/100 Base-T Jack with Magnetic Module

ARJ11B-MASAC-MU2 Abracon LLC CONN JACK 1PORT 100 BASE-T PCB



16.26 x 13.84 x 21.59mm

ARJ11B

RoHS
Compliant

STANDARD SPECIFICATIONS: 25°C (contd)

| Part Number | Return Loss (dB min @ 100Ω±15Ω) | | | | Crosstalk (dB min) | | | Common Mode Rejection (dB min) | | | Hipot (Vrms) |
|--------------------------------------|---------------------------------|--------|--------|-----------|--------------------|--------|---------|--------------------------------|--------|---------|--------------|
| | 1-30 MHz | 40 MHz | 50 MHz | 60-80 MHz | 30 MHz | 60 MHz | 100 MHz | 30 MHz | 60 MHz | 100 MHz | |
| ARJ11B-MASAA-MU2 to ARJ11B-MASAI-MU2 | -18 | -16 | -14 | -12 | -45 | -40 | -35 | -35 | -30 | -25 | 1500 |
| ARJ11B-MASAJ-MU2 to ARJ11B-MASAM-MU2 | -18 | -16 | -14 | -12 | -45 | -40 | -35 | -35 | -30 | -25 | 1500 |
| ARJ11B-MASAN-LU2 to ARJ11B-MASBF-LU2 | -18 | -16 | -14 | -12 | -45 | -40 | -35 | -35 | -30 | -25 | 1500 |
| ARJ11B-MESCB-A-B-ELT2 | -18 | -16 | -12 | -10 | -40 | -35 | -30 | -30 | -20 | -20 | 1500 |
| ARJ11B-MASCB-LT2 | -18 | -16 | -12 | -10 | -40 | -35 | -30 | -30 | -20 | -20 | 1500 |
| ARJ11B-MBSCB-A-B-ELT2 | -18 | -16 | -12 | -10 | -40 | -35 | -30 | -30 | -20 | -20 | 1500 |
| ARJ11B-MDSBQ-MU2 | -18 | -16 | -12 | -10 | -40 | -35 | -30 | -30 | -20 | -20 | 1500 |
| ARJ11B-MESBQ-A-B-EMU2 | -18 | -16 | -12 | -10 | -40 | -35 | -30 | -30 | -20 | -20 | 1500 |
| ARJ11B-MASBQ-MU2 | -18 | -16 | -12 | -10 | -40 | -35 | -30 | -30 | -20 | -20 | 1500 |
| ARJ11B-MBSBQ-A-B-EMU2 | -18 | -16 | -12 | -10 | -40 | -35 | -30 | -30 | -20 | -20 | 1500 |
| ARJ11B-MFSBQ-A-A-EMU2 | -18 | -16 | -12 | -10 | -40 | -35 | -30 | -30 | -20 | -20 | 1500 |
| ARJ11B-MASAJ-MU2 | -18 | -16 | -12 | -10 | -40 | -35 | -30 | -30 | -20 | -20 | 1500 |
| ARJ11B-MASBR-QU2 | -18 | -16 | -12 | -10 | -40 | -35 | -30 | -30 | -20 | -20 | 1500 |
| ARJ11B-MFSBR-A-A-EQU2 | -18 | -16 | -12 | -10 | -40 | -35 | -30 | -30 | -20 | -20 | 1500 |
| ARJ11B-MDSAO-LU2 | -18 | -16 | -12 | -10 | -40 | -35 | -30 | -30 | -20 | -20 | 1500 |
| ARJ11B-MESAO-A-B-ELU2 | -18 | -16 | -12 | -10 | -40 | -35 | -30 | -30 | -20 | -20 | 1500 |
| ARJ11B-MESAO-A-A-ELU2 | -18 | -16 | -12 | -10 | -40 | -35 | -30 | -30 | -20 | -20 | 1500 |
| ARJ11B-MASAO-LU2 | -18 | -16 | -12 | -10 | -40 | -35 | -30 | -30 | -20 | -20 | 1500 |
| ARJ11B-MBSAO-A-B-ELU2 | -18 | -16 | -12 | -10 | -40 | -35 | -30 | -30 | -20 | -20 | 1500 |
| ARJ11B-MFSAO-A-A-ELU2 | -18 | -16 | -12 | -10 | -40 | -35 | -30 | -30 | -20 | -20 | 1500 |
| ARJ11B-MFSAO-BA-A-GLU2 | -18 | -16 | -12 | -10 | -40 | -35 | -30 | -30 | -20 | -20 | 1500 |
| ARJ11B-MBSAP-A-B-ELU2 | -18 | -16 | -12 | -10 | -40 | -35 | -30 | -30 | -20 | -20 | 1500 |
| ARJ11B-MASAC-MU2 | -18 | -16 | -12 | -10 | -40 | -35 | -30 | -30 | -20 | -20 | 1500 |
| ARJ11B-MASAD-OW2 | -- | -- | -- | -- | -40 | -35 | -30 | -30 | -20 | -20 | 1500 |
| ARJ11B-MBSAI-A-B-EMU2 | -18 | -16 | -12 | -10 | -40 | -35 | -30 | -30 | -20 | -20 | 1500 |
| ARJ11B-MASCC-MU2 | -18 | -16 | -12 | -10 | -40 | -35 | -30 | -30 | -20 | -20 | 1500 |
| ARJ11B-MESBW-B-A-EMU2 | -18 | -16 | -12 | -10 | -40 | -35 | -30 | -30 | -20 | -20 | 1500 |

Contact Abracon for more custom configurations. See options to build a custom configuration.

OPTIONS & PART IDENTIFICATION:

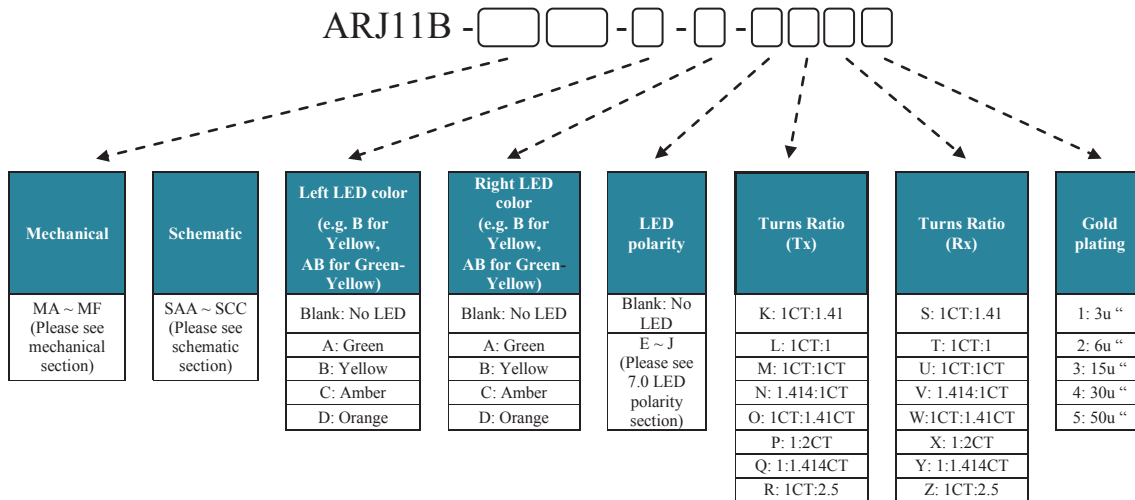

ABRACON IS
ISO 9001:2008
CERTIFIED



ABRACON
CORPORATION

Visit www.abracon.com for Terms & Conditions of Sale
30332 Esperanza, Rancho Santa Margarita, California 92688
tel 949-546-8000 | fax 949-546-8001 | www.abracon.com

Revised: 04.21.11

RJ45 10/100 Base-T Jack with Magnetic Module

ARJ11B-MASAC-MU2 Abracon LLC CONN JACK 1PORT 100 BASE-T PCB

ARJ11B

RoHS
Compliant



16.26 x 13.84 x 21.59mm

SCHEMATICS

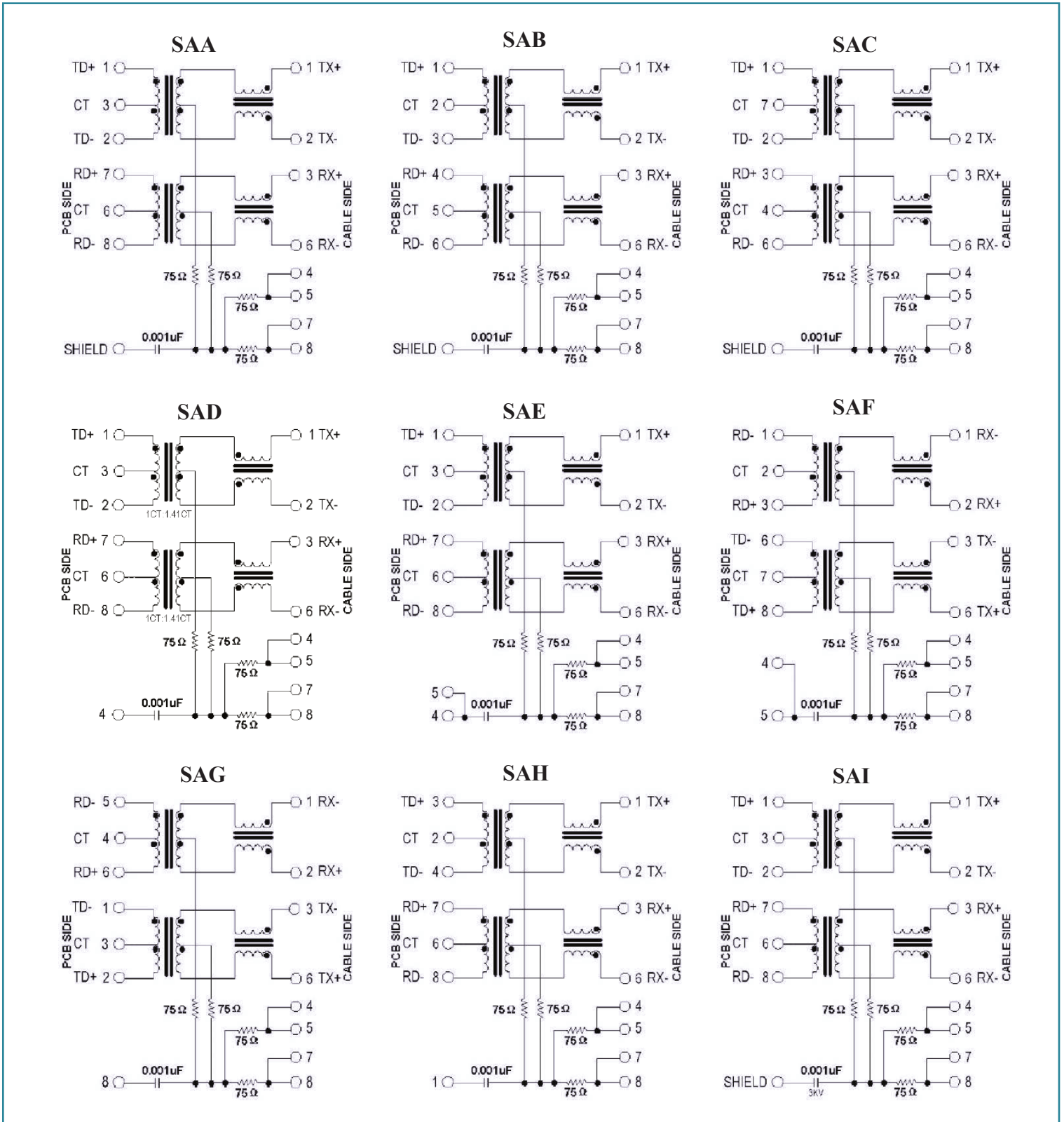

ABRACON IS
ISO 9001:2008
CERTIFIED

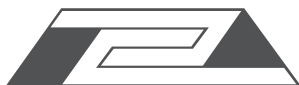

ABRACON
CORPORATION

Visit www.abracon.com for Terms & Conditions of Sale
30332 Esperanza, Rancho Santa Margarita, California 92688
tel 949-546-8000 | fax 949-546-8001 | www.abracon.com

Revised: 04.21.11

RJ45 10/100 Base-T Jack with Magnetic Module

ARJ11B-MASAC-MU2 Abracon LLC CONN JACK 1PORT 100 BASE-T PCB



16.26 x 13.84 x 21.59mm

ARJ11B

RoHS
Compliant

SCHEMATICS

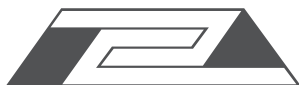
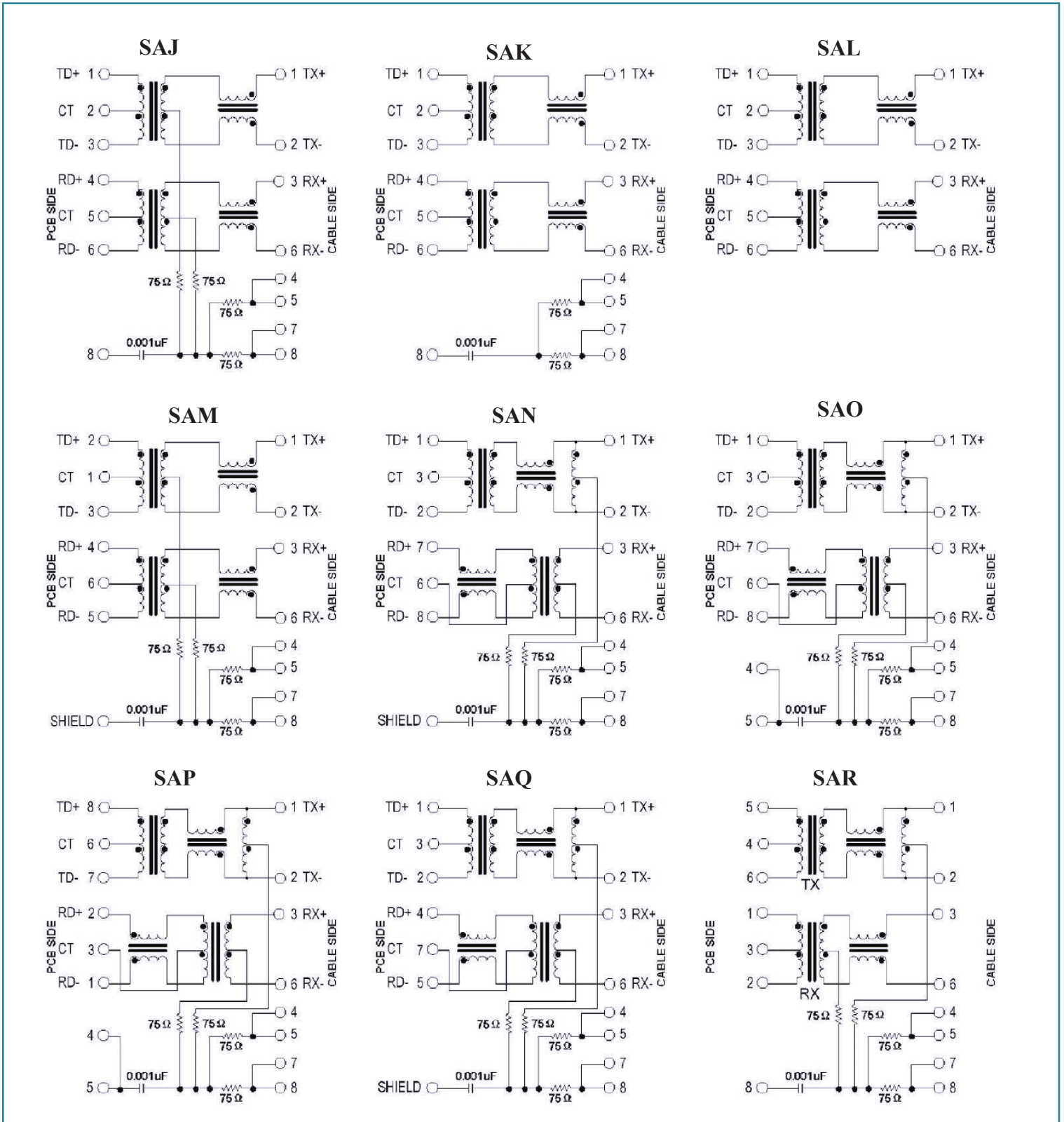

RJ45 10/100 Base-T Jack with Magnetic Module

ARJ11B-MASAC-MU2 Abracon LLC CONN JACK 1PORT 100 BASE-T PCB

ARJ11B

RoHS
Compliant



16.26 x 13.84 x 21.59mm

SCHEMATICS

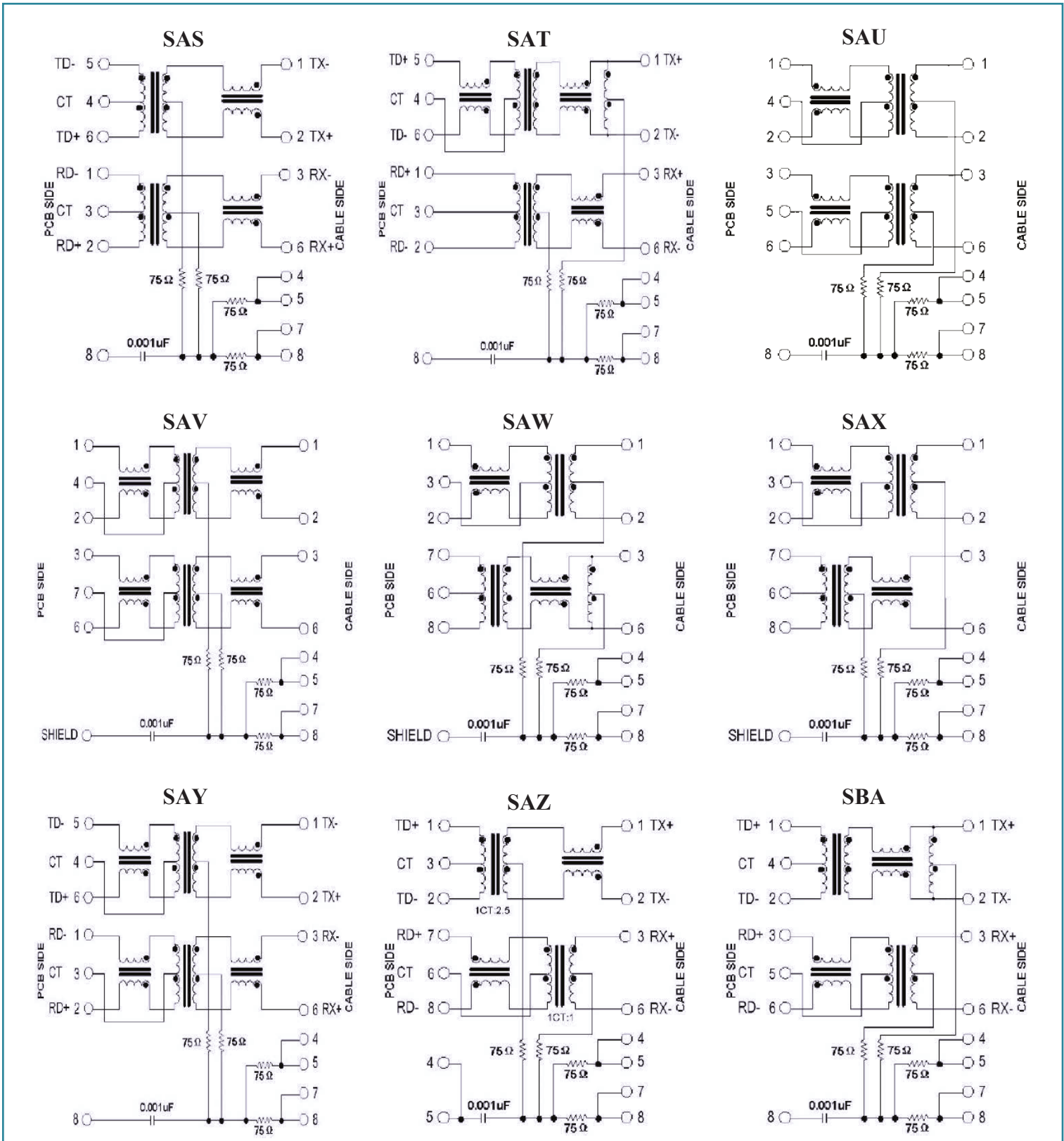

ABRACON IS
ISO 9001:2008
CERTIFIED

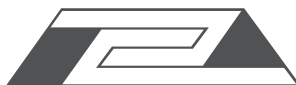

ABRACON
CORPORATION

Visit www.abracon.com for Terms & Conditions of Sale
30332 Esperanza, Rancho Santa Margarita, California 92688
tel 949-546-8000 | fax 949-546-8001 | www.abracon.com

Revised: 04.21.11

RJ45 10/100 Base-T Jack with Magnetic Module

ARJ11B-MASAC-MU2 Abracon LLC CONN JACK 1PORT 100 BASE-T PCB



16.26 x 13.84 x 21.59mm

ARJ11B

RoHS
Compliant

SCHEMATICS

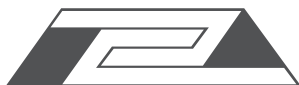
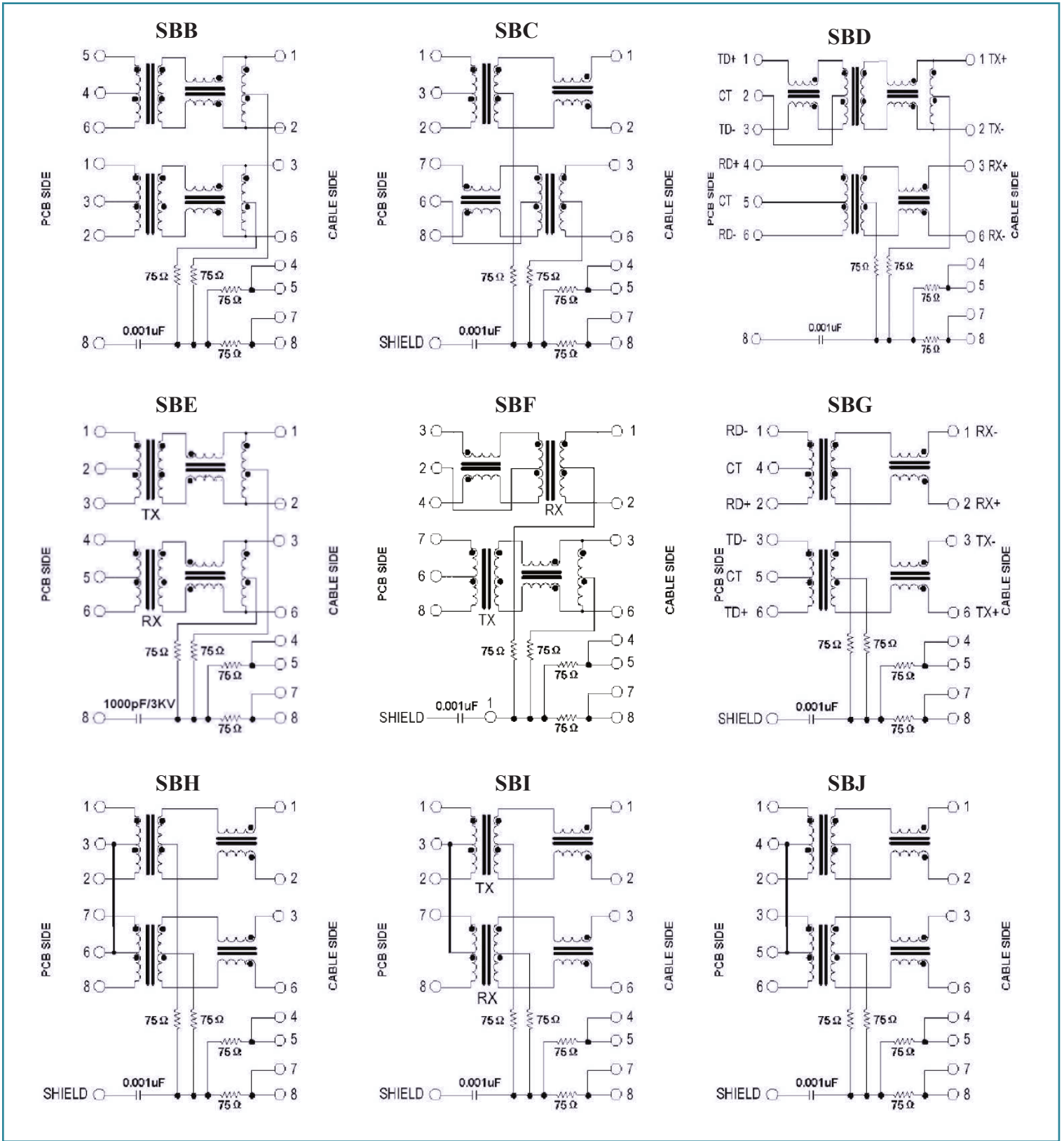

RJ45 10/100 Base-T Jack with Magnetic Module

ARJ11B-MASAC-MU2 Abracon LLC CONN JACK 1PORT 100 BASE-T PCB



16.26 x 13.84 x 21.59mm

ARJ11B

RoHS
Compliant

SCHEMATICS

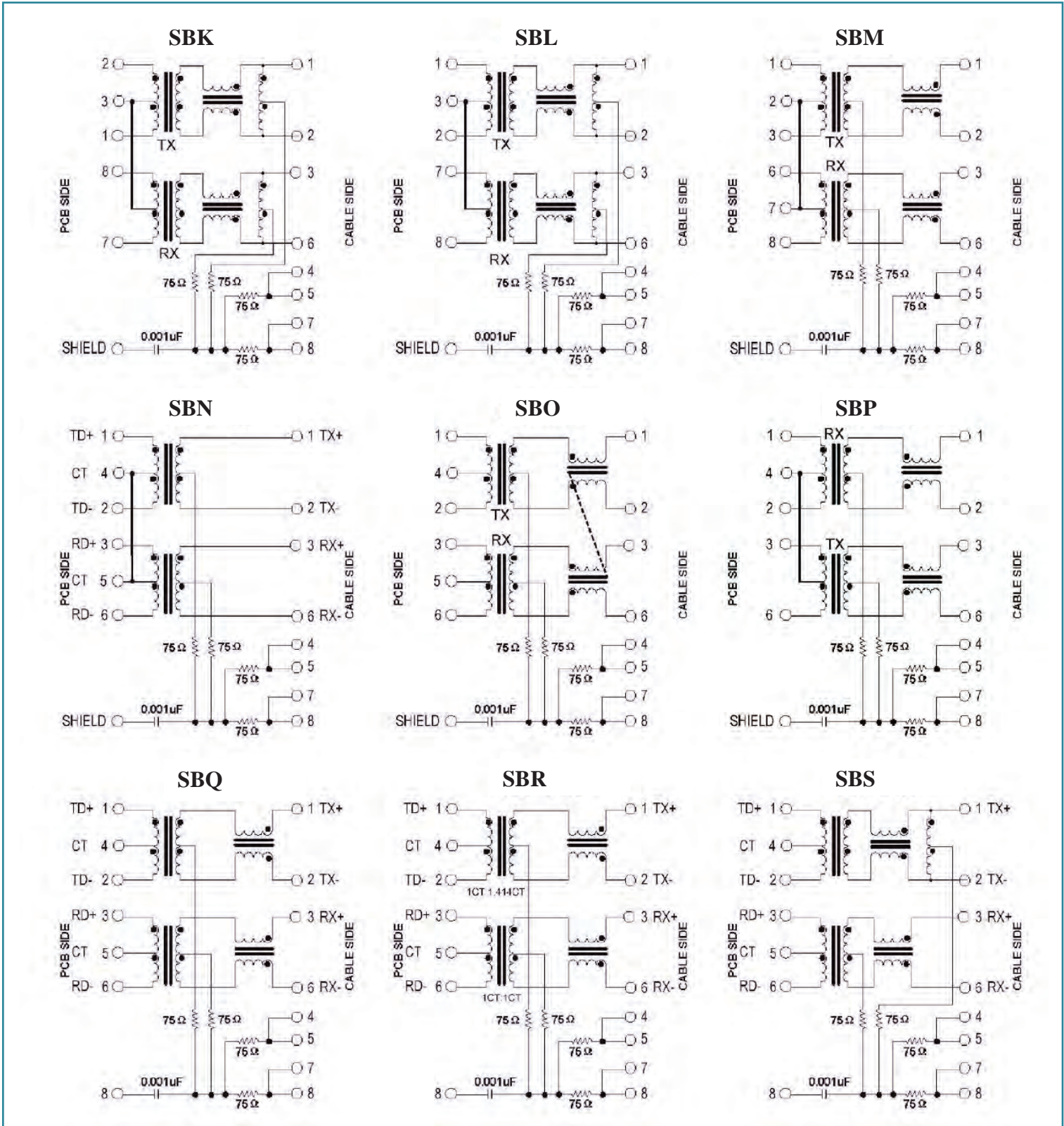

ABRACON IS
ISO 9001:2008
CERTIFIED

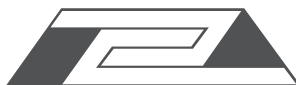

ABRACON
CORPORATION

Visit www.abracon.com for Terms & Conditions of Sale
30332 Esperanza, Rancho Santa Margarita, California 92688
tel 949-546-8000 | fax 949-546-8001 | www.abracon.com

Revised: 04.21.11

RJ45 10/100 Base-T Jack with Magnetic Module

ARJ11B-MASAC-MU2 Abracon LLC CONN JACK 1PORT 100 BASE-T PCB

ARJ11B

RoHS
Compliant



16.26 x 13.84 x 21.59mm

SCHEMATICS

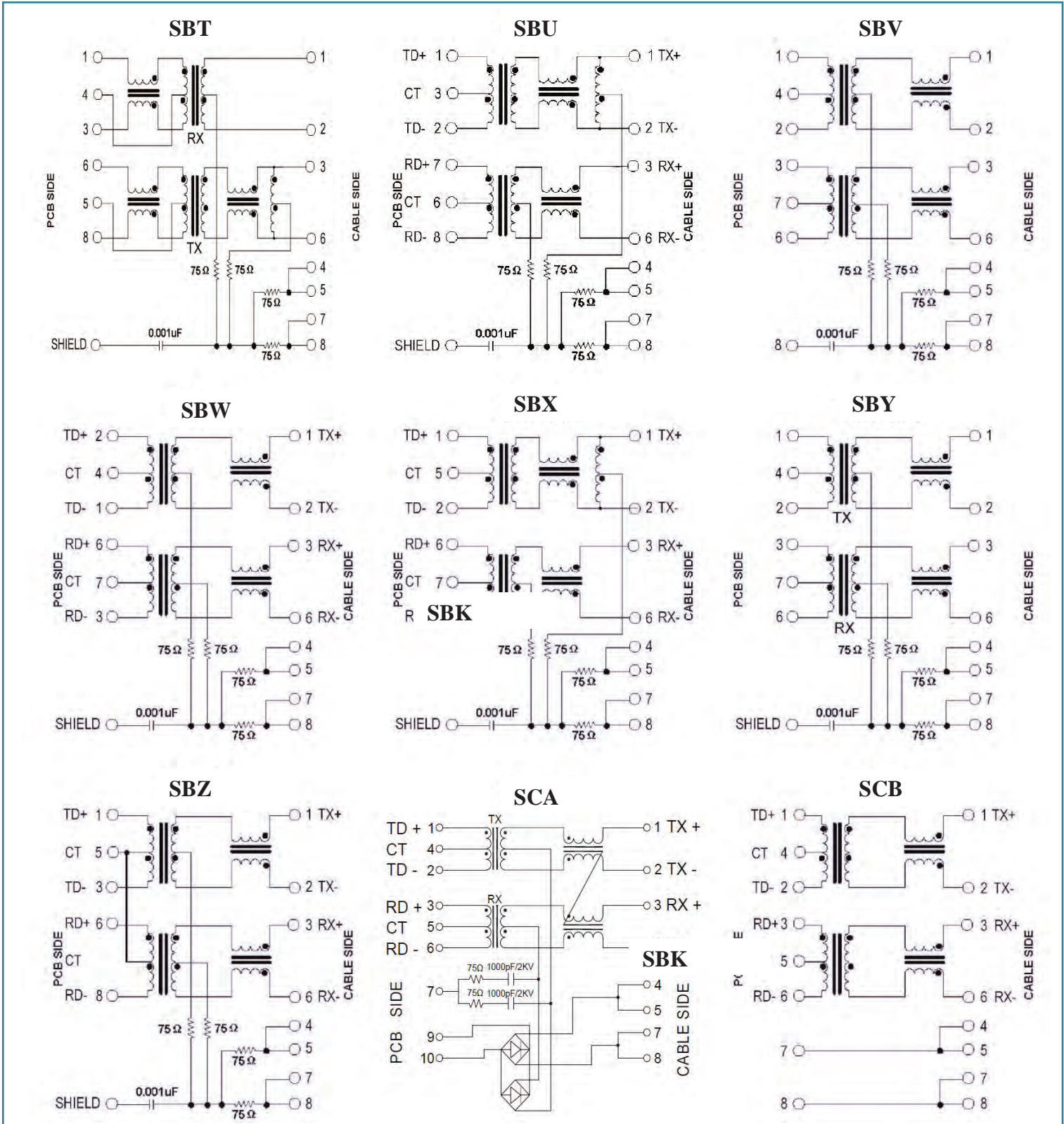

ABRACON IS
ISO 9001:2008
CERTIFIED

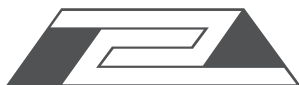

ABRACON
CORPORATION

Visit www.abracon.com for Terms & Conditions of Sale
30332 Esperanza, Rancho Santa Margarita, California 92688
tel 949-546-8000 | fax 949-546-8001 | www.abracon.com

Revised: 04.21.11

RJ45 10/100 Base-T Jack with Magnetic Module

ARJ11B-MASAC-MU2 Abracon LLC CONN JACK 1PORT 100 BASE-T PCB

ARJ11B

RoHS
Compliant



16.26 x 13.84 x 21.59mm

SCHEMATICS

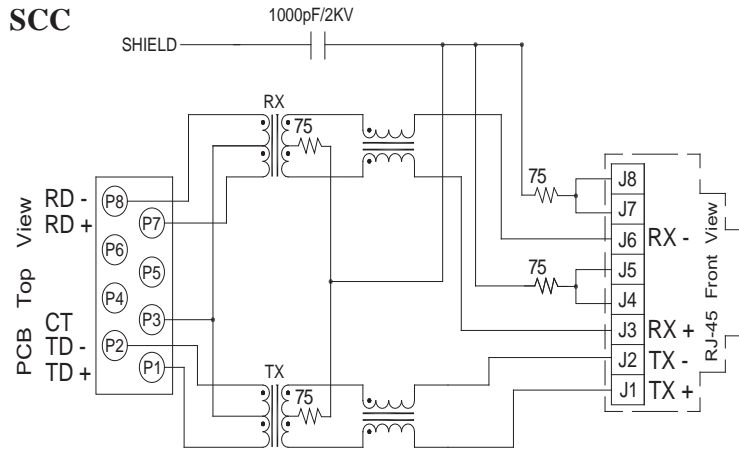

LED POLARITY

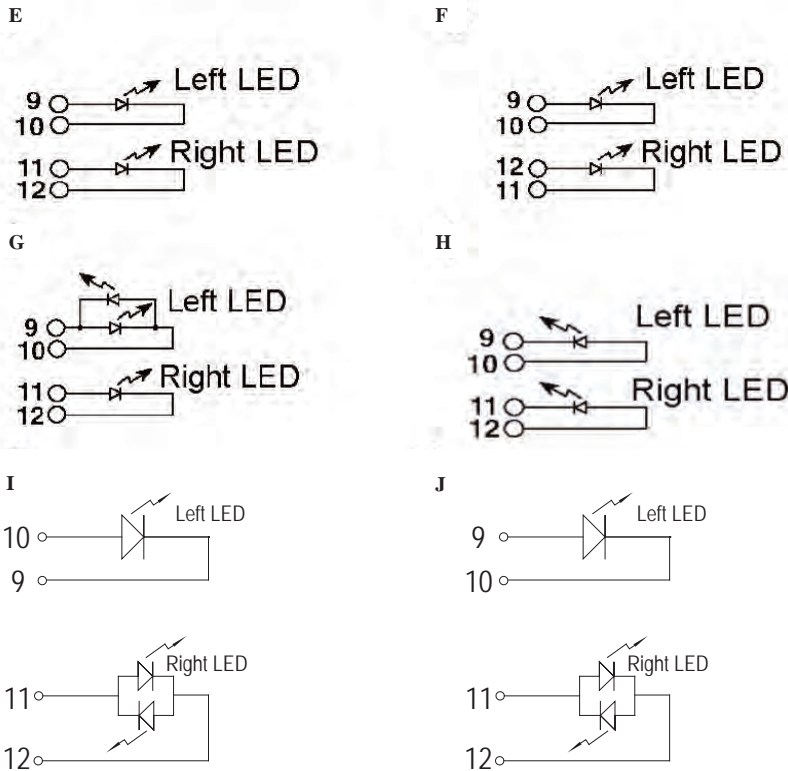

Vin=2.1Vdc TYP. 2.5Vdc MAX.

ABRACON IS
ISO 9001:2008
CERTIFIED



Visit www.abracon.com for Terms & Conditions of Sale
30332 Esperanza, Rancho Santa Margarita, California 92688
tel 949-546-8000 | fax 949-546-8001 | www.abracon.com

Revised: 04.21.11

RJ45 10/100 Base-T Jack with Magnetic Module

ARJ11B-MASAC-MU2 Abracon LLC CONN JACK 1PORT 100 BASE-T PCB



16.26 x 13.84 x 21.59mm

ARJ11B

RoHS
Compliant

REFLOW PROFILE

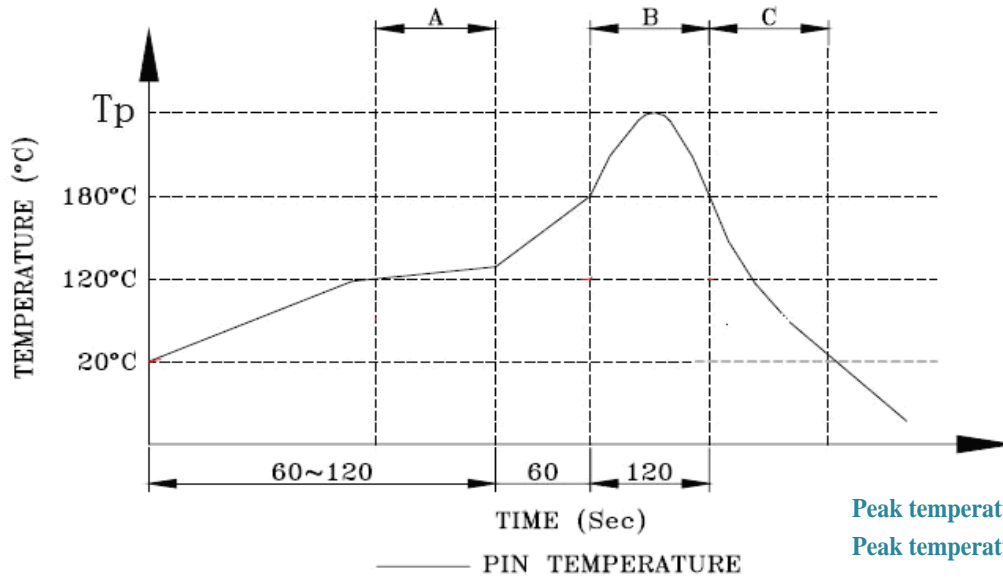

A. Preheating B. Soldering C. Gradual Cooling

TAPE & REEL:

Packing 60pcs/tray
Packaging material: PET

Outer carton unit 1320 pcs/ 22 Trays/box

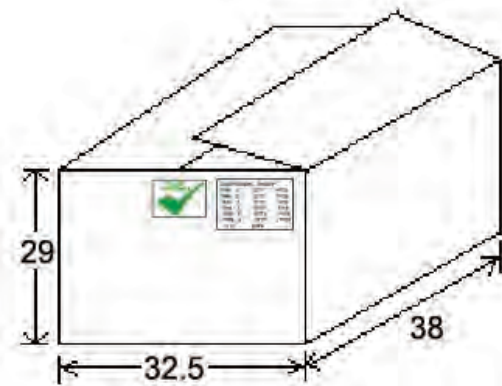
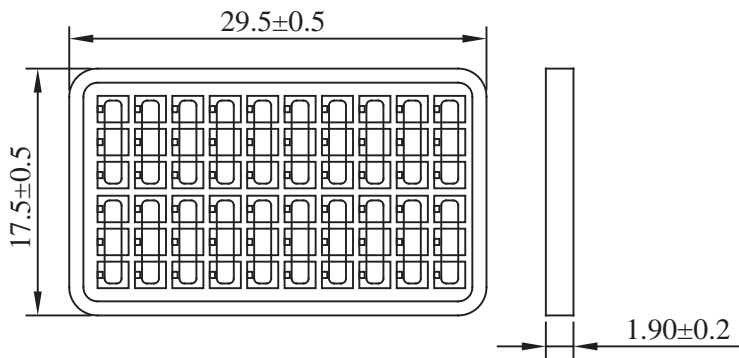

Dimensions: cm

ATTENTION: Abracon Corporation's products are COTS – Commercial-Off-The-Shelf products; suitable for Commercial, Industrial and, where designated, Automotive Applications. Abracon's products are not specifically designed for Military, Aviation, Aerospace, Life-dependant Medical applications or any application requiring high reliability where component failure could result in loss of life and/or property. For applications requiring high reliability and/or presenting an extreme operating environment, written consent and authorization from Abracon Corporation is required. Please contact Abracon Corporation for more information.

ABRACON IS
ISO 9001:2008
CERTIFIED



ABRACON
CORPORATION

Visit www.abracon.com for Terms & Conditions of Sale
30332 Esperanza, Rancho Santa Margarita, California 92688
tel 949-546-8000 | fax 949-546-8001 | www.abracon.com

Revised: 04.21.11

OUR CERTIFICATE

DiGi provide top-quality products and perfect service for customer worldwide through standardization, technological innovation and continuous improvement. DiGi through third-party certification, we stricly control the quality of products and services. Welcome your RFQ to

Email: Info@DiGi-Electronics.com



Tel: +00 852-30501935

RFQ Email: Info@DiGi-Electronics.com

DiGi is a global authorized distributor of electronic components.