

ASPI-0630HI-1R0M-T15 Datasheet

www.digi-electronics.com

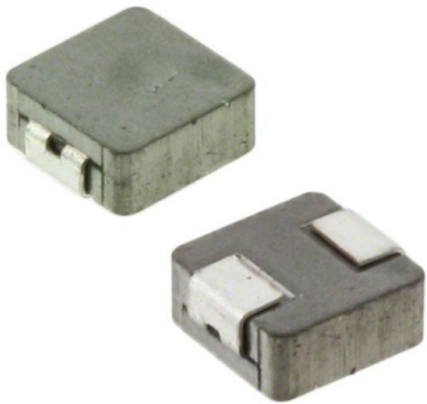

<https://www.DiGi-Electronics.com>

| | |
|------------------------------|--|
| DiGi Electronics Part Number | ASPI-0630HI-1R0M-T15-DG |
| Manufacturer | Abracon LLC |
| Manufacturer Product Number | ASPI-0630HI-1R0M-T15 |
| Description | FIXED IND 1UH 11A 10 MOHM SMD |
| Detailed Description | 1 μ H Shielded Molded Inductor 11 A 10mOhm Max Nonstandard |



Tel: +00 852-30501935

RFQ Email: Info@DiGi-Electronics.com

DiGi is a global authorized distributor of electronic components.

Purchase and inquiry

Manufacturer Product Number:

ASPI-0630HI-1R0M-T15

Series:

ASPI-0630HI

Type:

Molded

Inductance:

1 μ H

Current Rating (Amps):

11 A

Shielding:

Shielded

Q @ Freq:

-

Ratings:

-

Inductance Frequency - Test:

100 kHz

Package / Case:

Nonstandard

Size / Dimension:

0.283" L x 0.262" W (7.20mm x 6.65mm)

Manufacturer:

Abracon LLC

Product Status:

Active

Material - Core:

Carbonyl Powder

Tolerance:

\pm 20%

Current - Saturation (Isat):

20.5A

DC Resistance (DCR):

10mOhm Max

Frequency - Self Resonant:

-

Operating Temperature:

-55°C ~ 125°C

Mounting Type:

Surface Mount

Supplier Device Package:

-

Height - Seated (Max):

0.118" (3.00mm)

Environmental & Export classification

RoHS Status:

ROHS3 Compliant

REACH Status:

REACH Unaffected

HTSUS:

8504.50.8000

Moisture Sensitivity Level (MSL):

1 (Unlimited)

ECCN:

EAR99

Molded Power Inductor



ASPI-0630HI Series

Request Samples



Check Inventory



7.2 x 6.6 x 3.0 mm
RoHS/RoHS II Compliant
 MSL Level = 1

Features

- High saturation current
- Low loss due to low DC resistance.
- Frequency application up to 3MHz.
- Low profile with max thickness 3.0mm.
- 100% lead free and meets RoHS standard.
- Suitable for reflow soldering.
- High reliability SMD package

Applications

- DC/DC converters
- Notebook/Laptop power circuitry
- Desktop, Workstation, Server power circuitry
- Low profile, high current power supplies.

Electrical Specifications

| Part Number | Inductance | DCR | | Saturation Current | Temperature Rise Current | Dim E |
|------------------|---------------|------------------|------------------|--------------------|--------------------------|-------|
| | | Typ | Max | | | |
| Units | μH | $\text{m}\Omega$ | $\text{m}\Omega$ | A | A | mm |
| Symbol | L | | | Isat | Irms | |
| ASPI-0630HI-R10M | 0.10 | 1.15 | 1.7 | 60.0 | 32.5 | 2.0 |
| ASPI-0630HI-R15M | 0.15 | 1.35 | 2.5 | 52.0 | 26.0 | 2.0 |
| ASPI-0630HI-R20M | 0.20 | 2.45 | 3.0 | 41.0 | 24.0 | 3.0 |
| ASPI-0630HI-R22M | 0.22 | 2.45 | 2.8 | 40.0 | 23.0 | 3.0 |
| ASPI-0630HI-R33M | 0.33 | 3.1 | 3.9 | 30.0 | 20.0 | 3.0 |
| ASPI-0630HI-R47M | 0.47 | 4.0 | 4.2 | 26.0 | 17.5 | 3.0 |
| ASPI-0630HI-R56M | 0.56 | 4.8 | 5.0 | 25.5 | 16.5 | 3.0 |
| ASPI-0630HI-R68M | 0.68 | 4.95 | 5.5 | 25.0 | 15.5 | 3.0 |
| ASPI-0630HI-R82M | 0.82 | 7.15 | 8.0 | 24.0 | 13.0 | 3.0 |
| ASPI-0630HI-1R0M | 1.0 | 9.3 | 10.0 | 22.0 | 11.0 | 3.0 |
| ASPI-0630HI-1R2M | 1.2 | 11.6 | 13.0 | 20.0 | 10.0 | 3.0 |
| ASPI-0630HI-1R5M | 1.5 | 13.5 | 15.0 | 18.0 | 9.0 | 3.0 |
| ASPI-0630HI-1R8M | 1.8 | 14.9 | 18.0 | 16.0 | 8.5 | 3.0 |
| ASPI-0630HI-2R2M | 2.2 | 18.3 | 20.0 | 14.0 | 8.0 | 3.0 |
| ASPI-0630HI-3R3M | 3.3 | 28.0 | 30.0 | 13.5 | 6.0 | 3.0 |
| ASPI-0630HI-4R7M | 4.7 | 38.0 | 40.0 | 10.0 | 5.5 | 3.0 |
| ASPI-0630HI-5R6M | 5.6 | 46.9 | 50.0 | 9.0 | 5.0 | 3.0 |
| ASPI-0630HI-6R8M | 6.8 | 54.8 | 60.0 | 8.0 | 4.5 | 3.0 |
| ASPI-0630HI-8R2M | 8.2 | 61.5 | 68.0 | 7.5 | 4.0 | 3.0 |
| ASPI-0630HI-100M | 10.0 | 102.5 | 105.0 | 7.0 | 3.0 | 3.0 |

ASPI-0630HI is RoHS/RoHS II Compliant and Pb free

MSL level: 1



5101 Hidden Creek Ln, Spicewood TX 78669
 Phone: 512-371-6159 Fax: 512-351-8858
 For terms and conditions of sales, please visit:
www.abracon.com

REVISION B : 3/31/2022

ABRACON IS
 ISO9001-2015
 CERTIFIED

Molded Power Inductor



ASPI-0630HI Series

Request Samples



Check Inventory



7.2 x 6.6 x 3.0 mm
 RoHS/RoHS II Compliant
 MSL Level = 1

Test Conditions

1. Temperature: 26°C ±3°C, Humidity: < 70% RH, Frequency 100KHz/0.25v
2. Inductance is measured in HP-4284A Precision LCR Meter.
3. RDC is measured in HP-4338B milli ohm meter.(or equivalent).
4. Isat: Based on inductance change ($\Delta L/L_0 : \leq -20\%$)
5. Irms: Based on temperature rise ($\Delta T : 40^\circ\text{C TYP.}$)

Operating Temperature

-55°C to +125°C (Including self-generated heat)

Storage Temperature and Humidity

+25°C to +35°C, 45% to 85% RH

Typical Performance Graphs

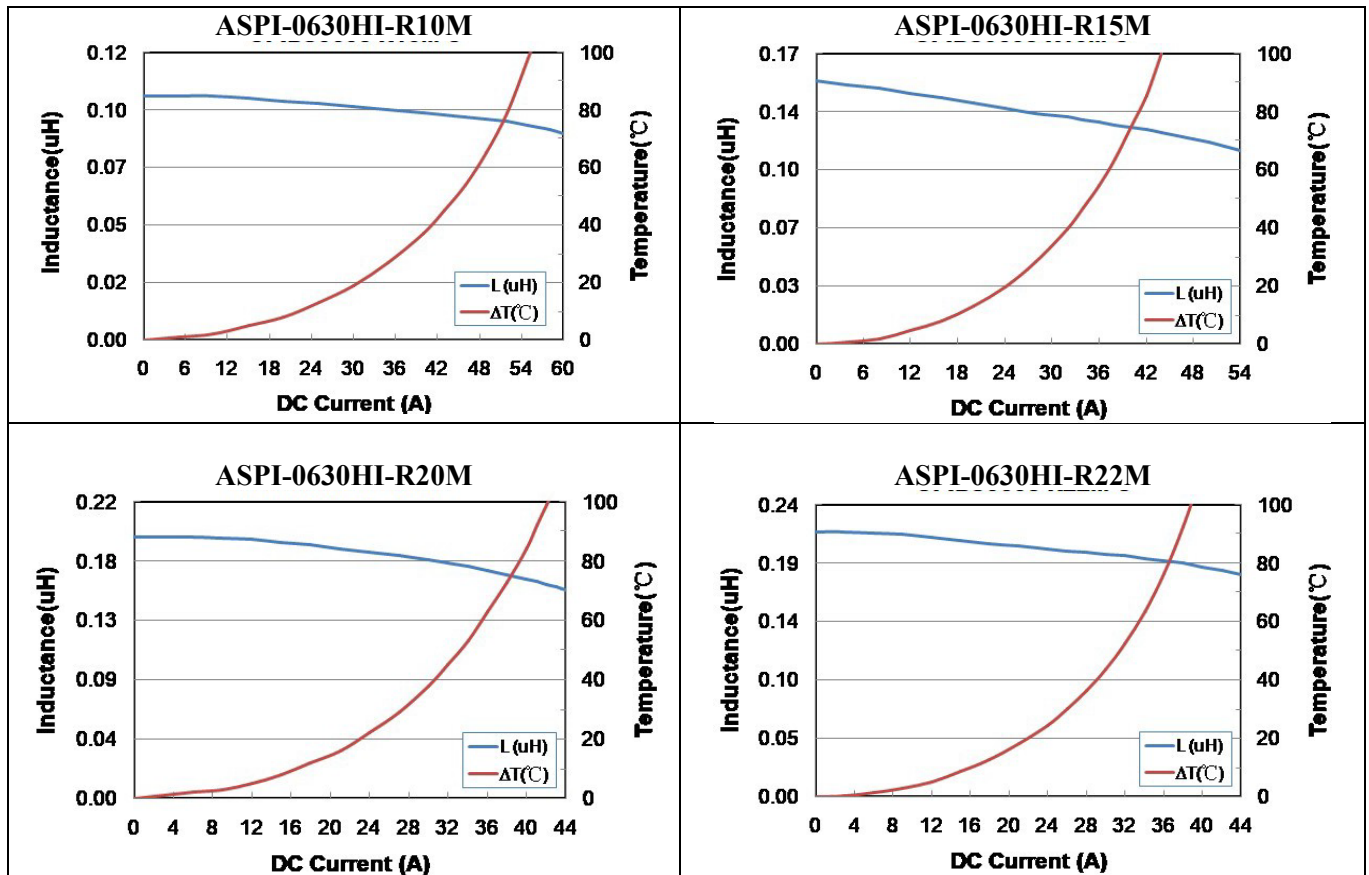

Molded Power Inductor

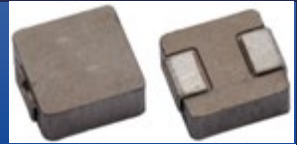

ASPI-0630HI Series

Request Samples



Check Inventory



7.2 x 6.6 x 3.0 mm
 RoHS/RoHS II Compliant
 MSL Level = 1

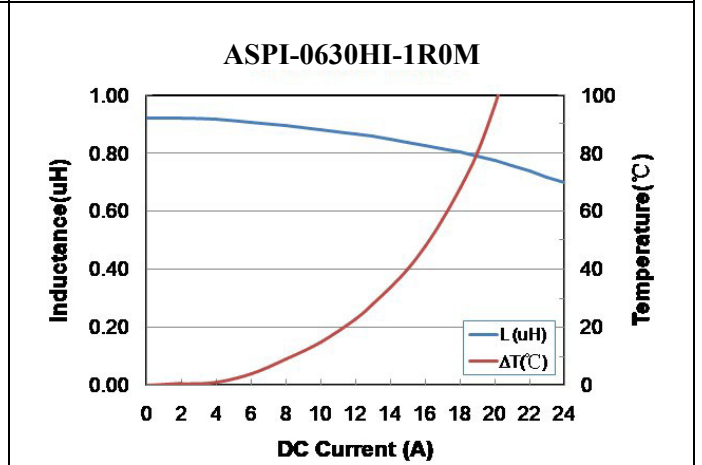
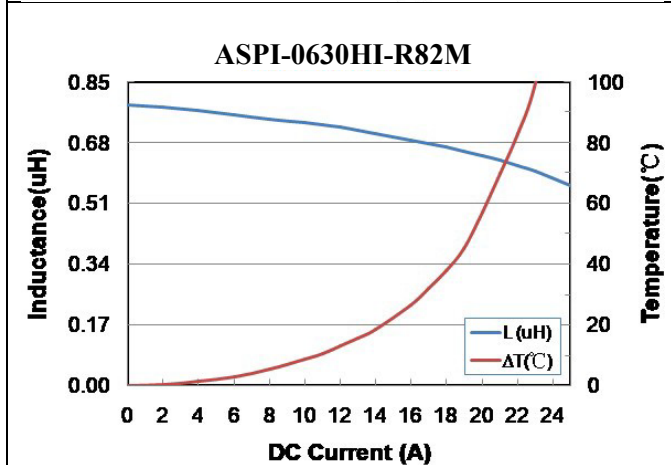
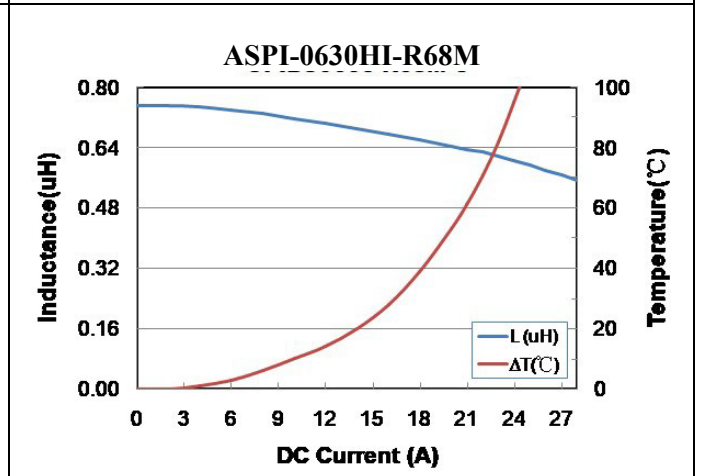
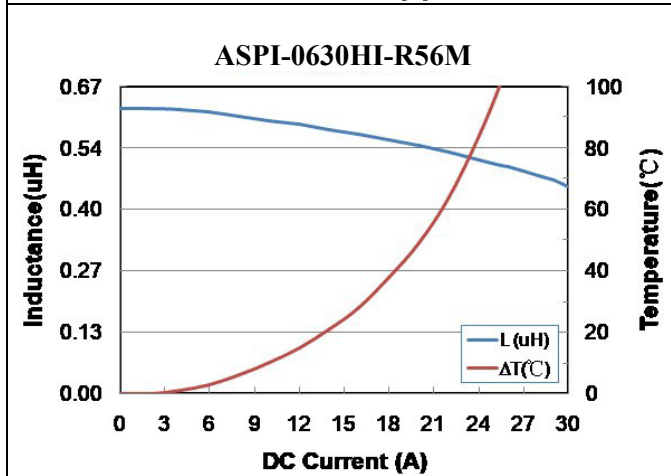
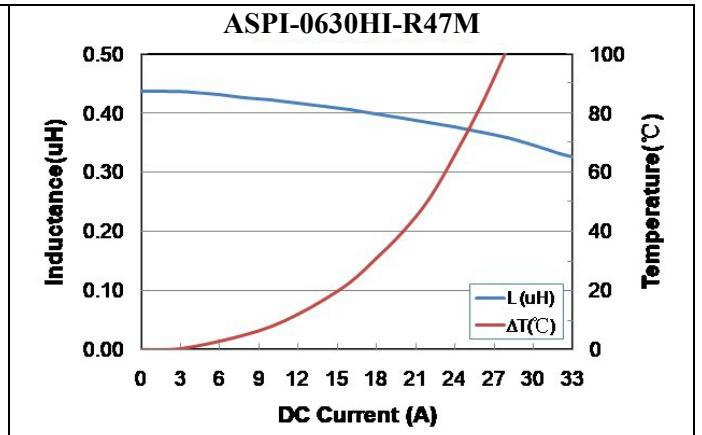
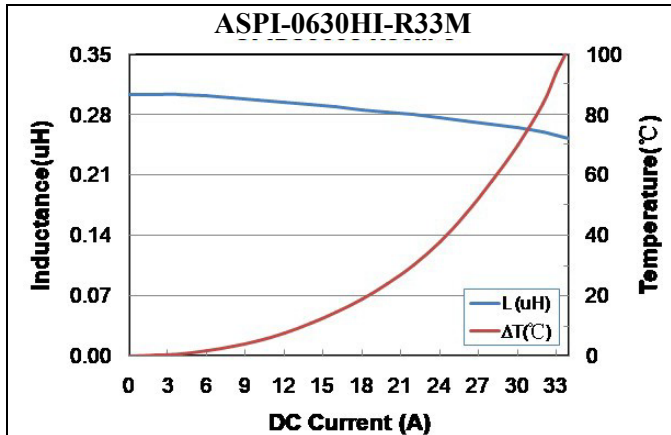

5101 Hidden Creek Ln, Spicewood TX 78669
 Phone: 512-371-6159 Fax: 512-351-8858
 For terms and conditions of sales, please visit:
www.abracon.com

REVISION B : 3/31/2022

ABRACON IS
 ISO9001-2015
 CERTIFIED

Molded Power Inductor

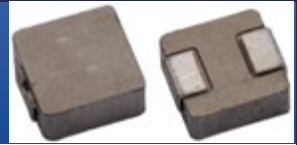

ASPI-0630HI Series

Request Samples



Check Inventory



7.2 x 6.6 x 3.0 mm
 RoHS/RoHS II Compliant
 MSL Level = 1

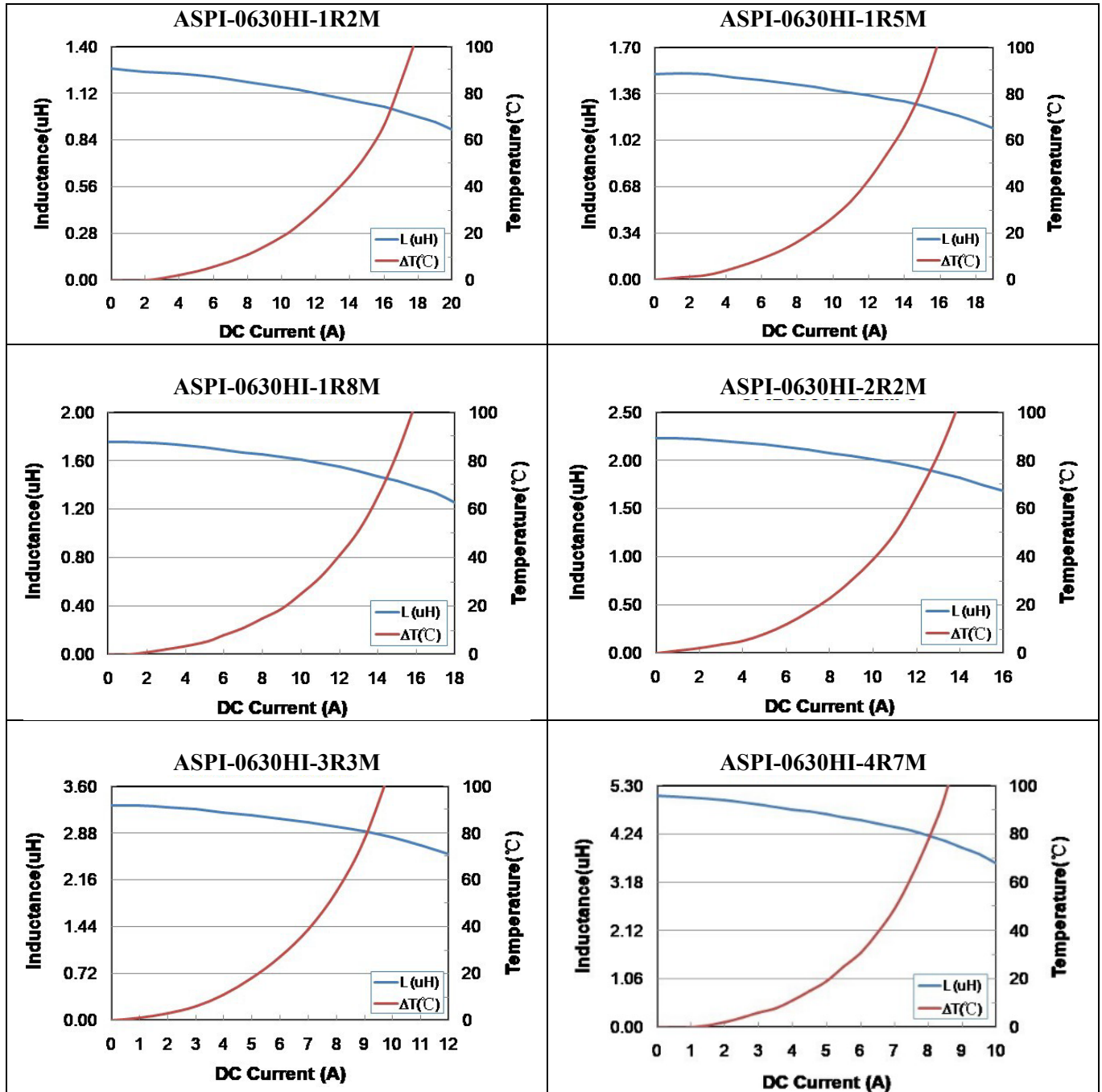

5101 Hidden Creek Ln, Spicewood TX 78669
 Phone: 512-371-6159 Fax: 512-351-8858
 For terms and conditions of sales, please visit:
www.abracon.com

REVISION B : 3/31/2022

ABRACON IS
 ISO9001-2015
 CERTIFIED

Molded Power Inductor

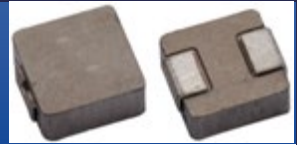

ASPI-0630HI Series

Request Samples



Check Inventory



7.2 x 6.6 x 3.0 mm
RoHS/RoHS II Compliant
 MSL Level = 1

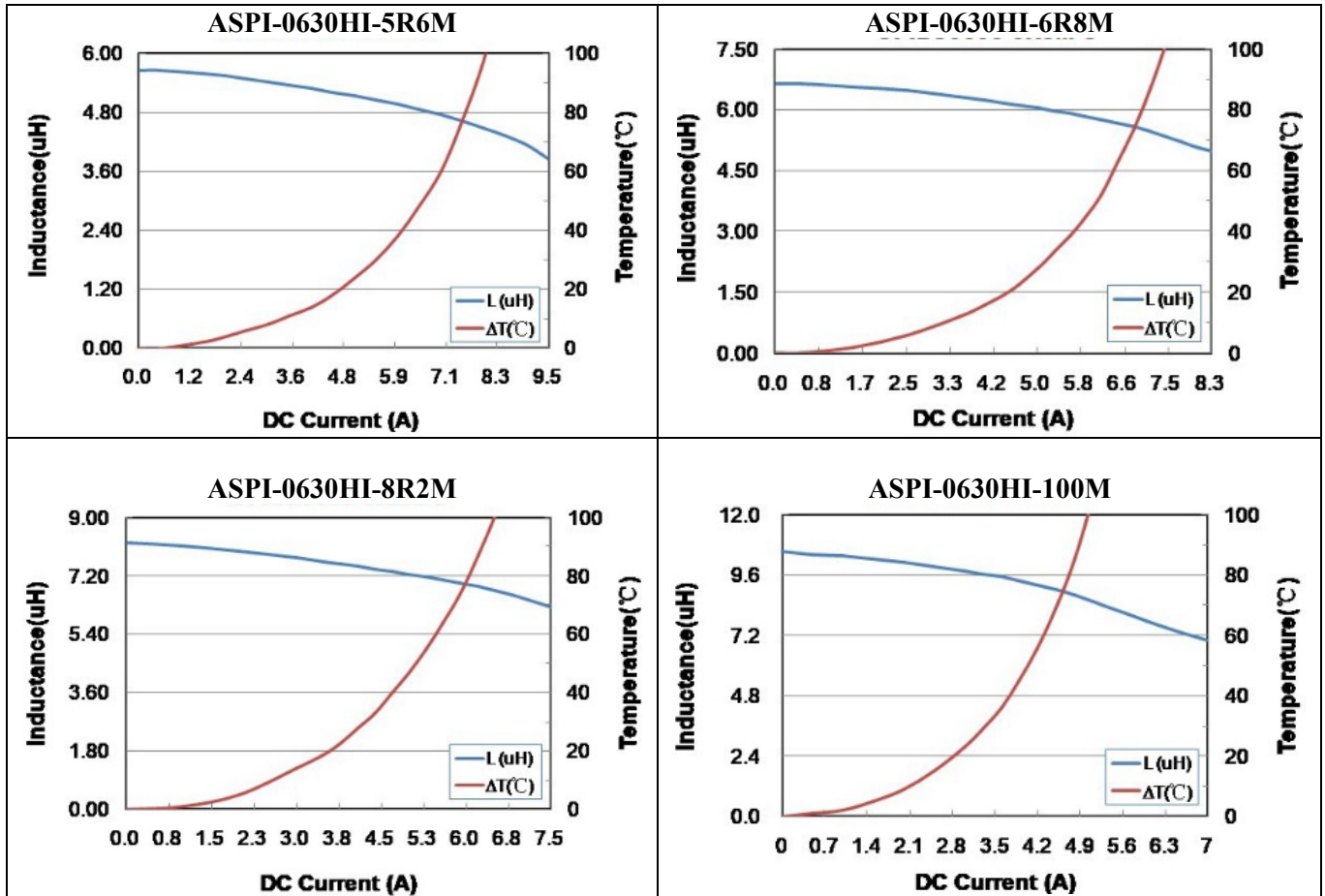

Part Number Identification

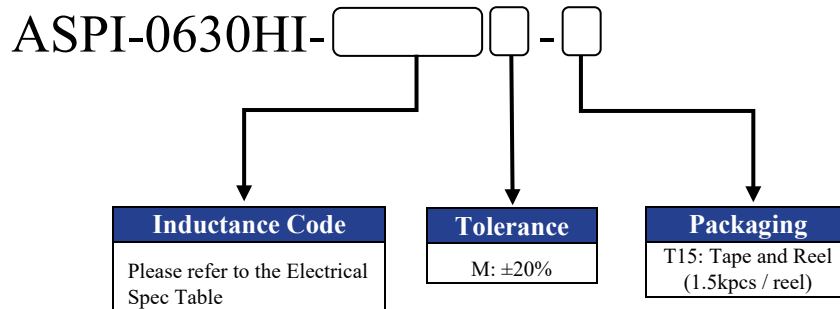

5101 Hidden Creek Ln, Spicewood TX 78669
 Phone: 512-371-6159 Fax: 512-351-8858
 For terms and conditions of sales, please visit:
www.abracon.com

REVISION B : 3/31/2022

ABRACON IS
 ISO9001-2015
 CERTIFIED

Molded Power Inductor



ASPI-0630HI Series

Request Samples



Check Inventory



7.2 x 6.6 x 3.0 mm
RoHS/RoHS II Compliant
MSL Level = 1

Marking

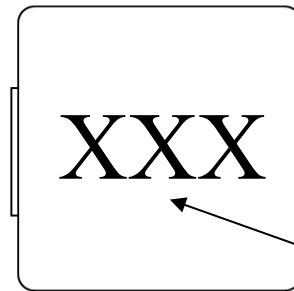

Inductance Code
e.g. 2R2

Marking Method = Ink Marking

Mechanical Specifications

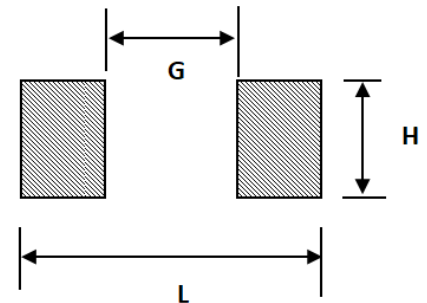
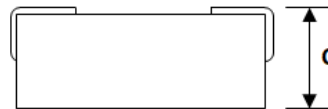
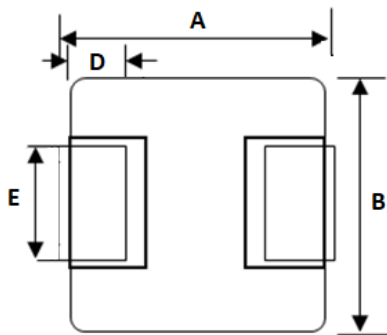

Recommended Layout

| A | B | C | D | E | G | H | L |
|----------|-----------|---------|----------|----------------------------|-----|-----|-----|
| 7.2 ±0.3 | 6.60 ±0.3 | 3.0 MAX | 1.6 ±0.3 | See Electrical Specs table | 3.7 | 3.5 | 8.0 |

Dimension: mm



5101 Hidden Creek Ln, Spicewood TX 78669
Phone: 512-371-6159 Fax: 512-351-8858
For terms and conditions of sales, please visit:
www.abracon.com

REVISION B : 3/31/2022

ABRACON IS
ISO9001-2015
CERTIFIED

Molded Power Inductor

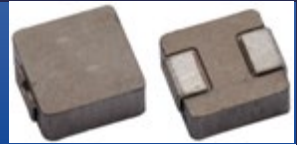

ASPI-0630HI Series

Request Samples



Check Inventory



7.2 x 6.6 x 3.0 mm
RoHS/RoHS II Compliant
 MSL Level = 1

Materials List

| No | Part Name | Material |
|----|-----------|------------------------|
| 1 | Core | Metal powder |
| 2 | Base | Cu + Ni + Sn plating |
| 3 | Wire | Copper wire, EIW Class |
| 4 | Marking | Ink(black) |
| 5 | Paint | Epoxy resin |

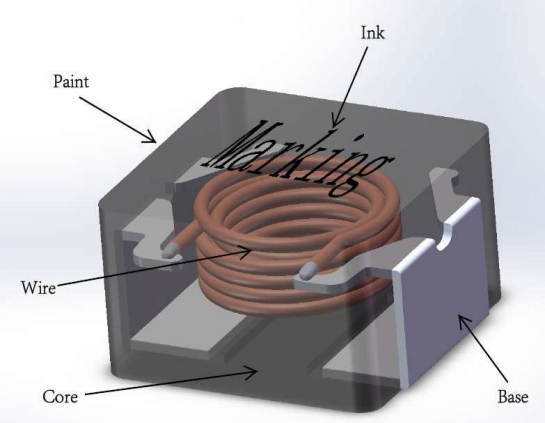

Molded Power Inductor



ASPI-0630HI Series

Request Samples



Check Inventory



7.2 x 6.6 x 3.0 mm
RoHS/RoHS II Compliant
MSL Level = 1

Reflow Profile

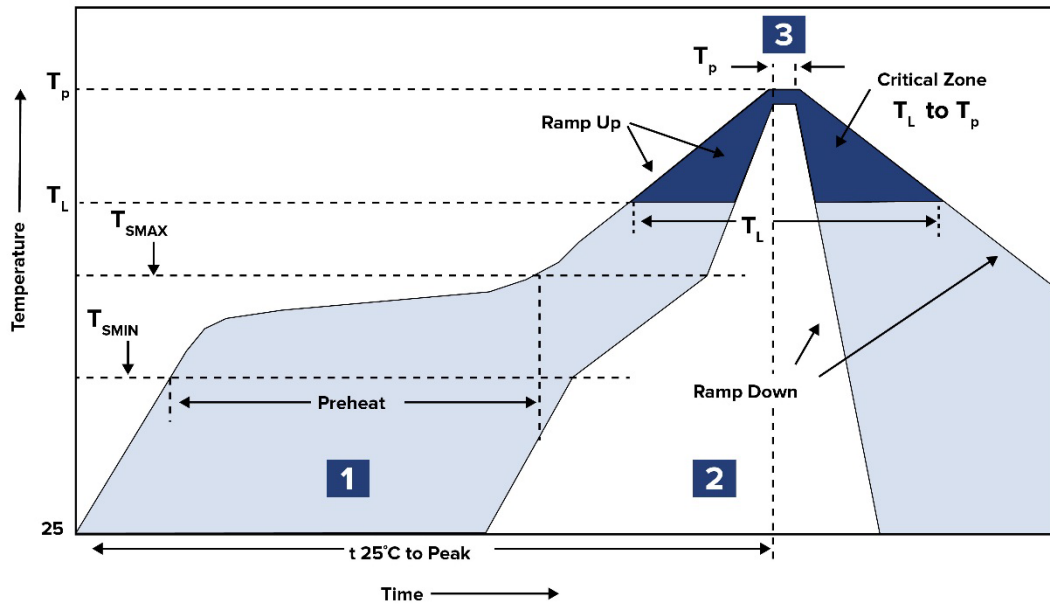

| Zone | Description | Temperature | Times |
|------|-------------|--|---------------|
| 1 | Preheat | $T_{SMIN} \sim T_{SMAX}$ $150^\circ\text{C} \sim 200^\circ\text{C}$ | 60 ~ 120 sec. |
| 2 | Reflow | T_L 217°C | 60 ~ 90 sec. |
| 3 | Peak heat | T_P $255^\circ\text{C} \pm 5^\circ\text{C}$ | 10 sec. MAX |

Molded Power Inductor

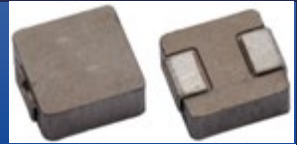

ASPI-0630HI Series

Request Samples



Check Inventory



7.2 x 6.6 x 3.0 mm
RoHS/RoHS II Compliant
 MSL Level = 1

Packaging

T15: 1,500pcs / reel

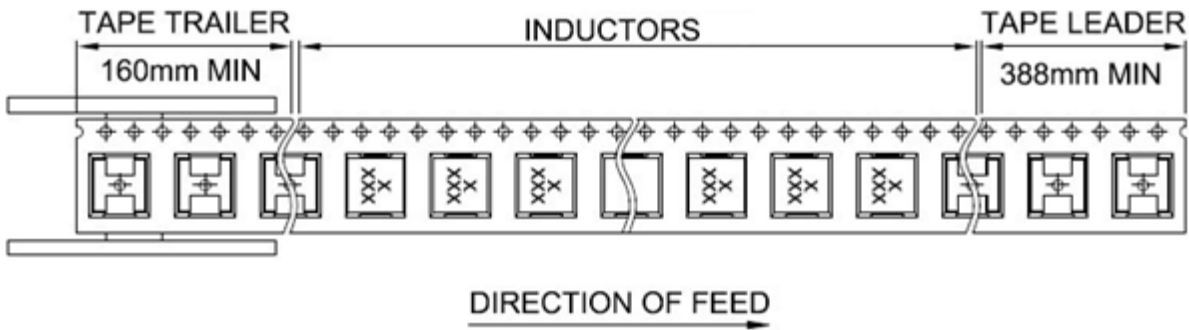
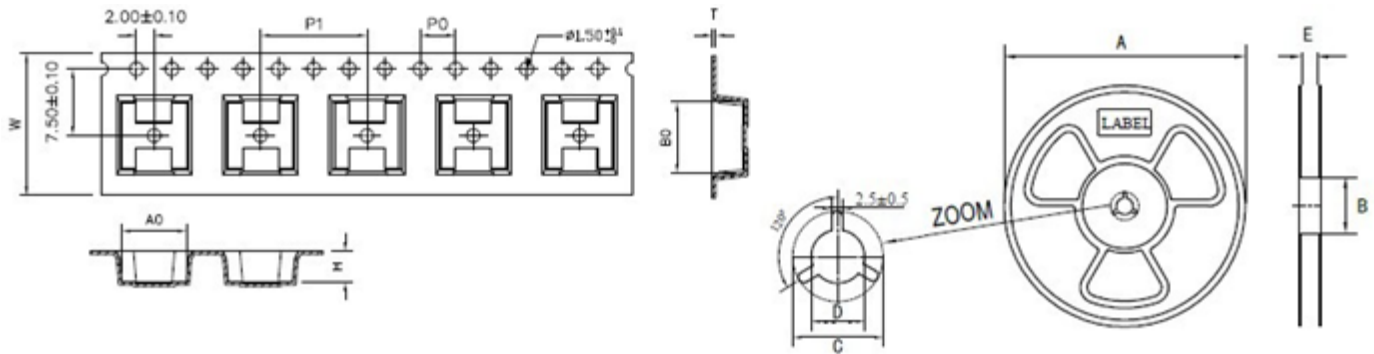

| Part Number | Reel Dimensions (mm) | | | | |
|-------------|----------------------|----------|----------|------------|------------|
| | A | B | C | D | E |
| ASPI-0630HI | 330 ±1 | 100 ±0.5 | 20.2 min | 13 +0.5/-0 | 16.4 +2/-0 |

| Part Number | Tap Dimensions (mm) | | | | | | |
|-------------|---------------------|---------|----------|----------|------------|----------|----------|
| | W | PI | P0 | H | T | A0 | B0 |
| ASPI-0630HI | 16 ±0.3 | 12 ±0.1 | 4.0 ±0.1 | 3.4 ±0.1 | 0.30 ±0.05 | 6.9 ±0.1 | 6.0 ±0.1 |

ATTENTION: Abracon LLC's products are COTS – Commercial-Off-The-Shelf products; suitable for Commercial, Industrial and, where designated, Automotive Applications. Abracon's products are not specifically designed for Military, Aviation, Aerospace, Life-dependent Medical applications or any application requiring high reliability where component failure could result in loss of life and/or property. For applications requiring high reliability and/or presenting an extreme operating environment, written consent and authorization from Abracon LLC is required. Please contact Abracon LLC for more information.



5101 Hidden Creek Ln, Spicewood TX 78669
 Phone: 512-371-6159 Fax: 512-351-8858
 For terms and conditions of sales, please visit:
www.abracon.com

REVISION B : 3/31/2022

ABRACON IS
 ISO9001-2015
 CERTIFIED

OUR CERTIFICATE

DiGi provide top-quality products and perfect service for customer worldwide through standardization, technological innovation and continuous improvement. DiGi through third-party certification, we stricly control the quality of products and services. Welcome your RFQ to

Email: Info@DiGi-Electronics.com



Tel: +00 852-30501935

RFQ Email: Info@DiGi-Electronics.com

DiGi is a global authorized distributor of electronic components.