

ASPIAIG-FLR4020-3R3M-T Datasheet

www.digi-electronics.com



<https://www.DiGi-Electronics.com>

DiGi Electronics Part Number	ASPIAIG-FLR4020-3R3M-T-DG
Manufacturer	Abracon LLC
Manufacturer Product Number	ASPIAIG-FLR4020-3R3M-T
Description	FIXED IND 3.3UH 5.5A 38.3MOHM SM
Detailed Description	3.3 μ H Shielded Molded Inductor 5.5 A 38.3mOhm Max Nonstandard



Tel: +00 852-30501935

RFQ Email: Info@DiGi-Electronics.com

DiGi is a global authorized distributor of electronic components.

Purchase and inquiry

Manufacturer Product Number:

ASPIAIG-FLR4020-3R3M-T

Series:

ASPIAIG-F

Type:

Molded

Inductance:

3.3 μ H

Current Rating (Amps):

5.5 A

Shielding:

Shielded

Q @ Freq:

-

Ratings:

AEC-Q200

Inductance Frequency - Test:

100 kHz

Mounting Type:

Surface Mount

Supplier Device Package:

4020

Height - Seated (Max):

0.083" (2.10mm)

Manufacturer:

Abracon LLC

Product Status:

Active

Material - Core:

-

Tolerance:

\pm 20%

Current - Saturation (Isat):

4.4A

DC Resistance (DCR):

38.3mOhm Max

Frequency - Self Resonant:

-

Operating Temperature:

-40°C ~ 125°C

Features:

-

Package / Case:

Nonstandard

Size / Dimension:

0.161" L x 0.161" W (4.10mm x 4.10mm)

Environmental & Export classification

RoHS Status:

ROHS3 Compliant

REACH Status:

REACH Unaffected

HTSUS:

8504.50.8000

Moisture Sensitivity Level (MSL):

1 (Unlimited)

ECCN:

EAR99



Molded SMD Power Inductor

ASPIAIG-FLR4020 Series

Request Samples



Check Inventory



4.4 x 4.4 x 1.9 mm

RoHS/RoHS II Compliant

MSL Level = 1

Features

- PPAP ready and supported
- TS16949 certified production lines
- AEC-Q200 qualified
- Excellent current capacity – up to 12.5A
- Exceptionally low DCR – only 6.8mΩ
- Soft saturation
- Low profile for compact designs
- Shielded constructions for low EMI

Applications

- Automotive grade 0 and electric vehicles
- ADAS and body electronics
- Infotainment systems
- Lighting
- Motor control
- Solar inverters and solar power
- DC/DC converters in distributed power systems
- Battery powered device

Electrical Specifications

Part Number	Inductance	Tolerance	DC Resistance	Saturation Current	Temperature Rise Current
	0.1MHz/0.1V		Max	Max	Max
Units	μH	%	mΩ	A	A
Symbol	L	M	DCR	Isat	Irms
ASPIAIG-FLR4020-R47	0.47	20%	6.8	12.5	13.2
ASPIAIG-FLR4020-R56	0.56	20%	7.8	11.3	12.6
ASPIAIG-FLR4020-R60	0.60	20%	7.8	11.1	12.4
ASPIAIG-FLR4020-R68	0.68	20%	8.2	10.0	12.0
ASPIAIG-FLR4020-R82	0.82	20%	9.5	9.0	11.5
ASPIAIG-FLR4020-1R0	1.00	20%	11.7	8.0	11.0
ASPIAIG-FLR4020-1R2	1.20	20%	13.4	7.5	9.5
ASPIAIG-FLR4020-1R5	1.50	20%	15.8	6.7	9.1
ASPIAIG-FLR4020-2R0	2.00	20%	23.3	5.0	8.2
ASPIAIG-FLR4020-2R2	2.20	20%	23.5	4.8	8.0
ASPIAIG-FLR4020-3R3	3.30	20%	38.3	4.4	5.5
ASPIAIG-FLR4020-4R7	4.70	20%	57.2	3.5	5.1

Test Conditions

Isat: Current at which the inductance drops 30% from its initial value

Irms: Current at which the temperature rises (ΔT , approximate 40 °C) from 20°C ambient

Operating Temperature: -55°C ~ +155°C (including self-temperature rise)

Storage Condition: -55°C ~ +155°C and R.H. 60% max (on PCB)

ASPIAIG-FLR4020 Series is **RoHS Compliant and Pb free**

ASPIAIG-FLR4020 Series is **AEC-Q200 Grade 0 qualified (-55°C ~ +155°C ambient)**

Operating Voltage: 15V

MSL level: 1



5101 Hidden Creek Ln Spicewood TX 78669
 Phone: 512-371-6159 | Fax: 512-351-8858
 For terms and conditions of sales, please visit:
www.abracon.com

REVISION A : 11/10/2021

ABRACON IS
 ISO9001-2015
 CERTIFIED



Molded SMD Power Inductor

ASPIAIG-FLR4020 Series

Request Samples



Check Inventory



4.4 x 4.4 x 1.9 mm

RoHS/RoHS II Compliant

MSL Level = 1

ASPIAIG-FLR4020-R47

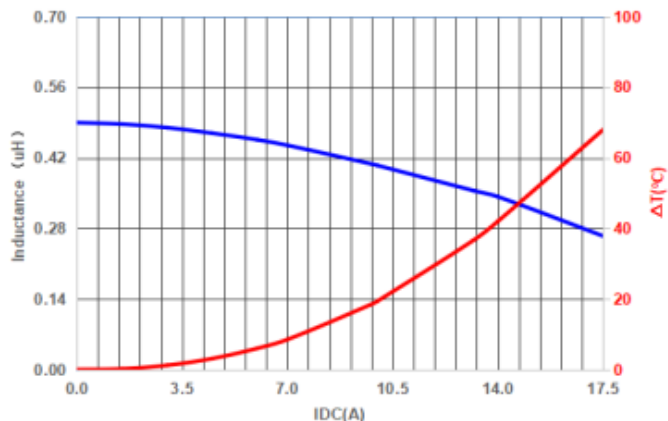

ASPIAIG-FLR4020-R56

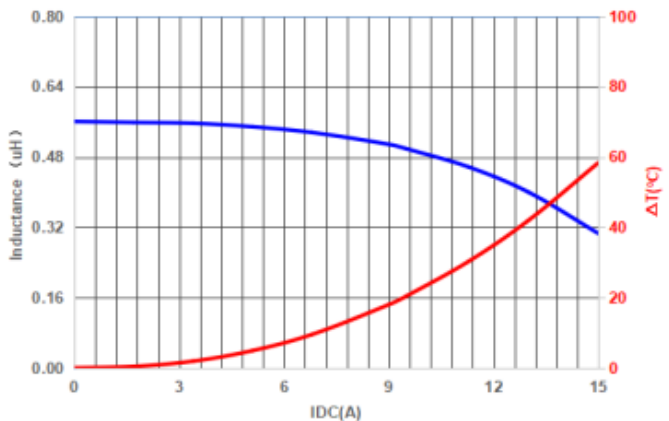

ASPIAIG-FLR4020-R60

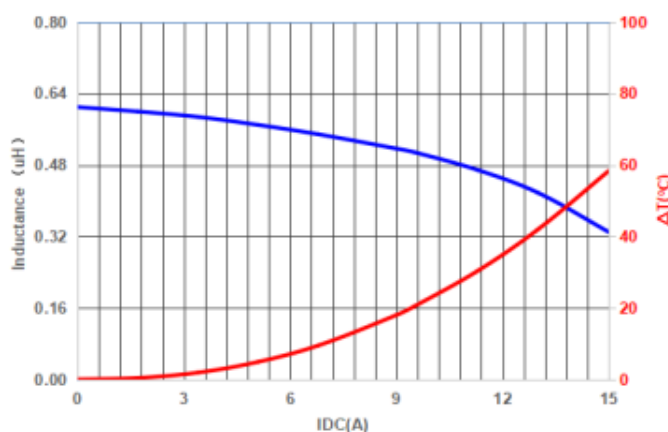

ASPIAIG-FLR4020-R68

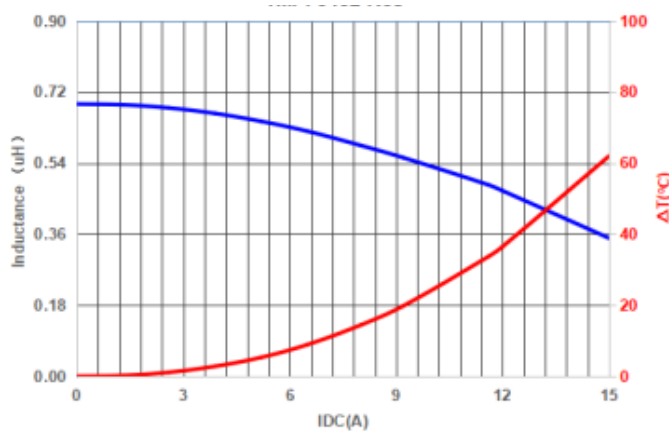

ASPIAIG-FLR4020-R82

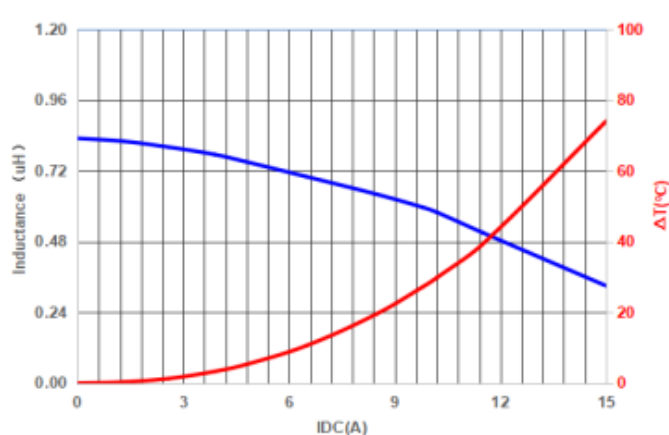

ASPIAIG-FLR4020-1R0

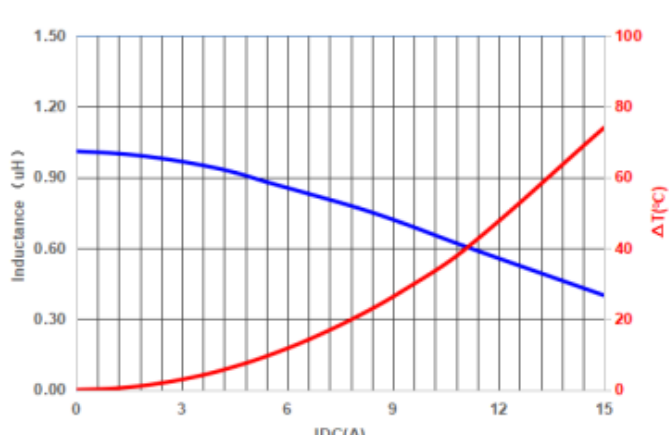

5101 Hidden Creek Ln Spicewood TX 78669
 Phone: 512-371-6159 | Fax: 512-351-8858
 For terms and conditions of sales, please visit:
www.abracon.com

REVISION A : 11/10/2021

ABRACON IS
 ISO9001-2015
 CERTIFIED

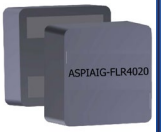

Molded SMD Power Inductor

ASPIAIG-FLR4020 Series

Request Samples



Check Inventory



4.4 x 4.4 x 1.9 mm
 RoHS/RoHS II Compliant
 MSL Level = 1

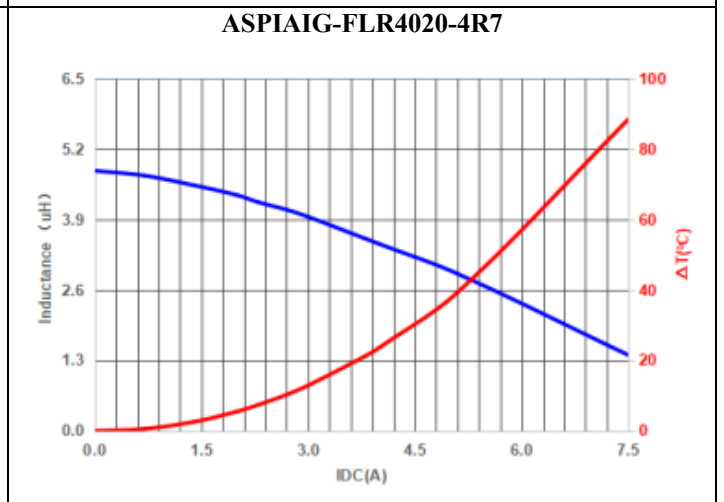
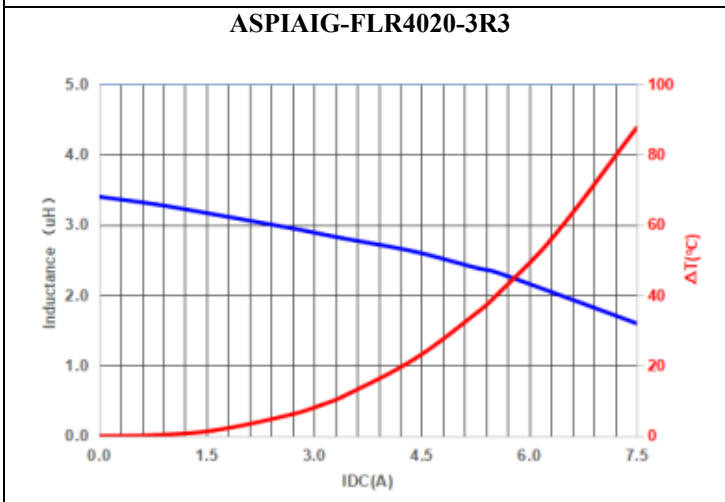
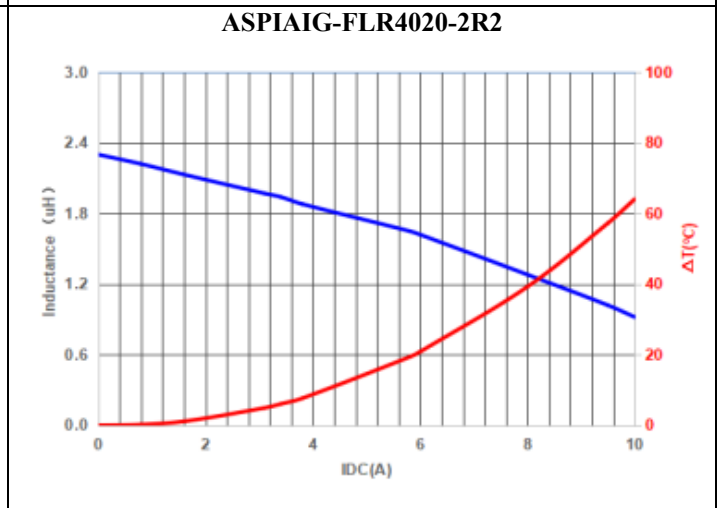
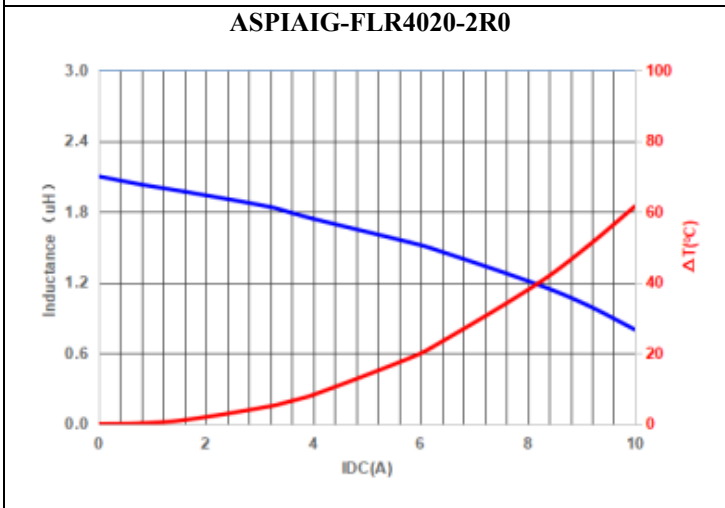
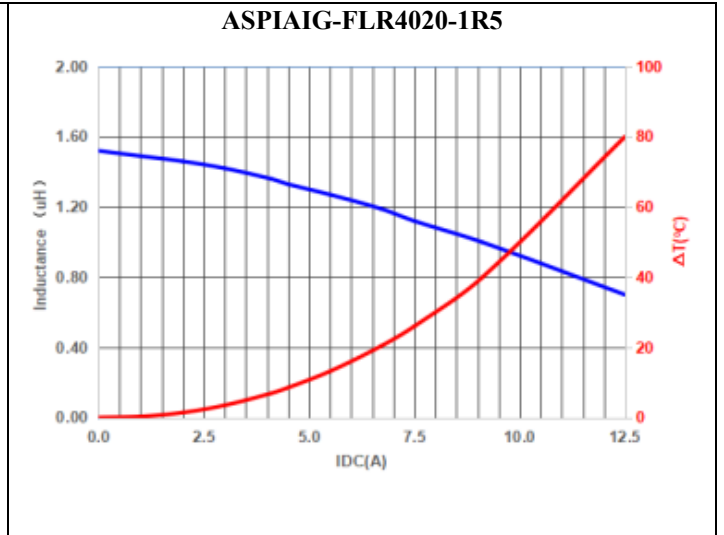
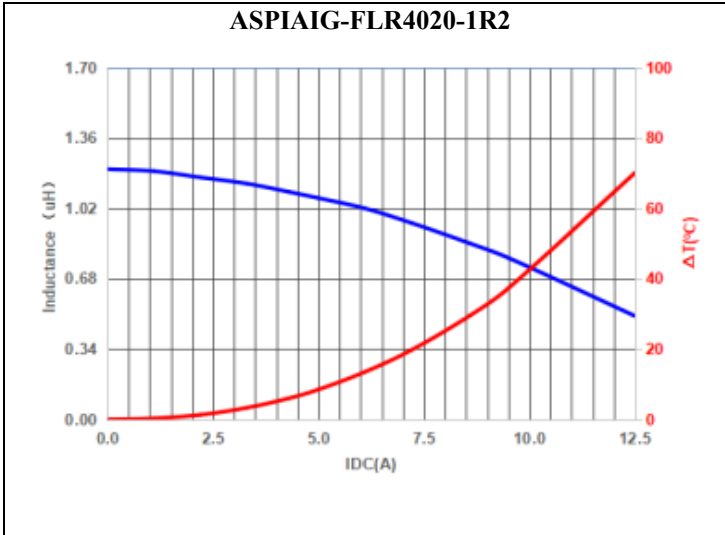

5101 Hidden Creek Ln Spicewood TX 78669
 Phone: 512-371-6159 | Fax: 512-351-8858
 For terms and conditions of sales, please visit:
www.abracon.com

REVISION A : 11/10/2021

ABRACON IS
 ISO9001-2015
 CERTIFIED



Molded SMD Power Inductor

ASPIAIG-FLR4020 Series

Request Samples



Check Inventory



4.4 x 4.4 x 1.9 mm
RoHS/RoHS II Compliant
MSL Level = 1

Mechanical Specifications

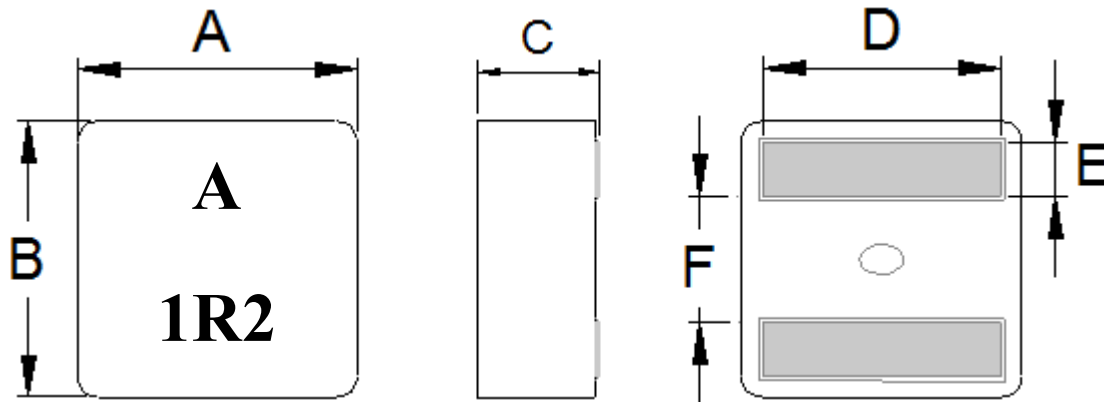

Series	A	B	C	D	E	F
ASPIAIG-FLR4020	4.4 ± 0.2	4.4 ± 0.2	1.9 ± 0.2	3.4 ± 0.3	0.88 ± 0.2	1.6 ± 0.25

Recommended Land Pattern

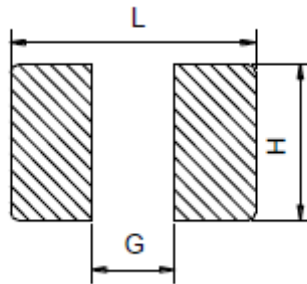

L Typ.	G Typ.	H Typ.
3.4	1.4	3.8

Dimension: mm



Molded SMD Power Inductor

ASPIAIG-FLR4020 Series

Request Samples



Check Inventory



4.4 x 4.4 x 1.9 mm
RoHS/RoHS II Compliant
 MSL Level = 1

Part Identification

ASPIAIG – FLR4020 - [] [] - []

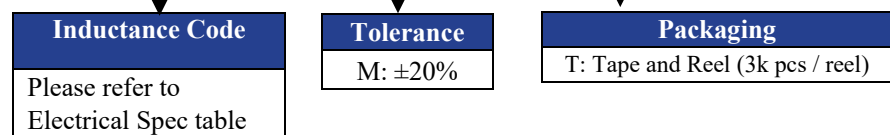

Marking

Marking Method: Ink

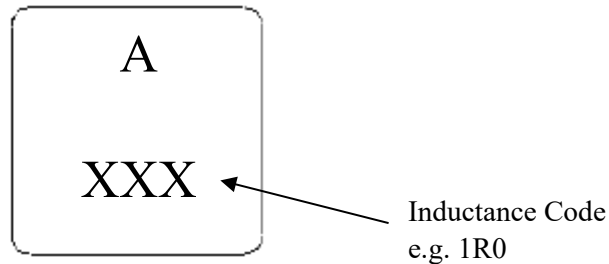

Materials

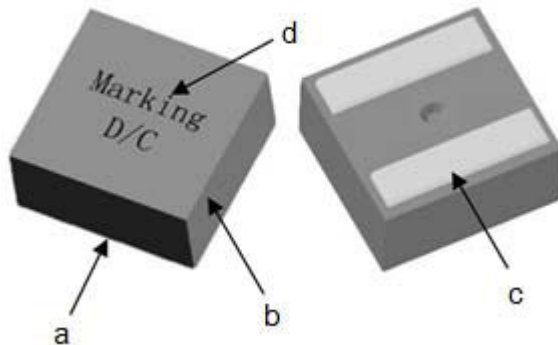

	Components	Material
a	Core	Alloy powder
b	Wire	220 deg. C Flat Wire
c	Solder	100% Pb free solder
d	Ink	Halogen-free ketone



Molded SMD Power Inductor

ASPIAIG-FLR4020 Series

Request Samples



Check Inventory



4.4 x 4.4 x 1.9 mm
 RoHS/RoHS II Compliant
 MSL Level = 1

Reflow Profile

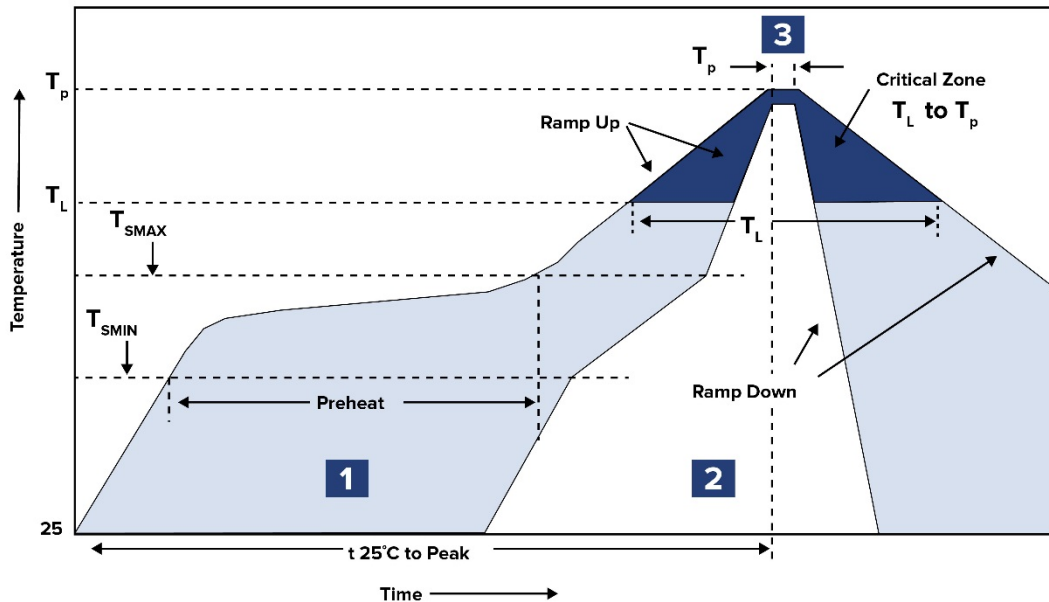

Zone	Description	Temperature	Times
1	Preheat	$T_{SMIN} \sim T_{SMAX}$ 150°C ~ 200°C	60 ~ 180 sec.
2	Reflow	T_L 217°C	60 ~ 150 sec.
3	Peak heat	T_P 260°C	10 sec. MAX



Molded SMD Power Inductor

ASPIAIG-FLR4020 Series

Request Samples



Check Inventory



4.4 x 4.4 x 1.9 mm

RoHS/RoHS II Compliant

MSL Level = 1

Packaging (Tape & Reel)

ASPIAIG-FLR4020: 3000pcs / reel

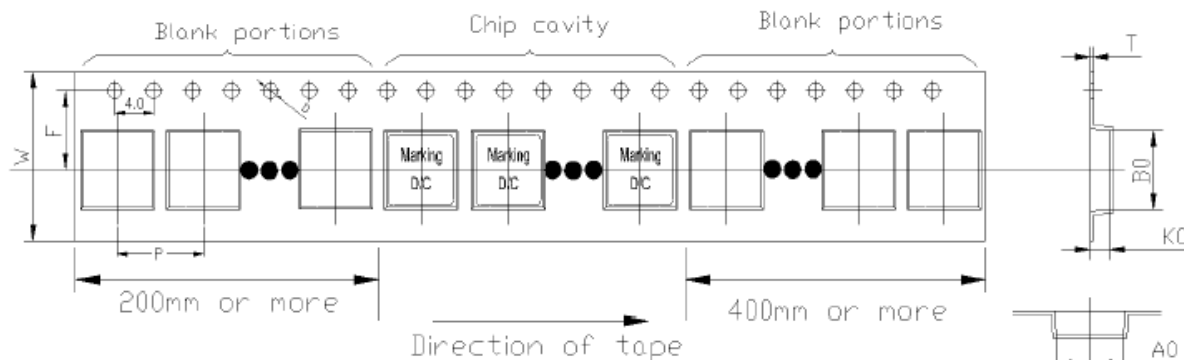

Series	W	F	P	D	A ₀	B ₀	T	K ₀
ASPIAIG-FLR4020	12.0±0.3	5.5±0.1	8.0±0.1	1.5±0.1	4.4±0.1	4.4 ±0.1	0.35±0.1	2.3±0.1

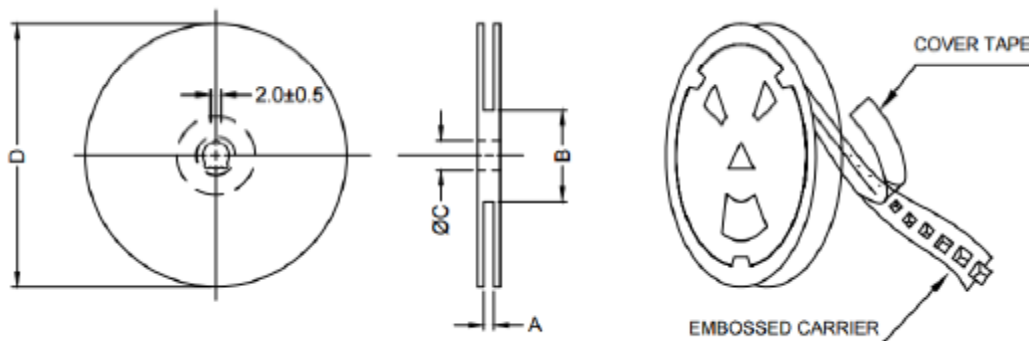

A	B	C	D
12.4+2/-0	100 ± 2	13.0+0.5/-0.2	330

Dimension: mm

ATTENTION: Abracon LLC's products are COTS – Commercial-Off-The-Shelf products; suitable for Commercial, Industrial and, where designated, Automotive Applications. Abracon's products are not specifically designed for Military, Aviation, Aerospace, Life-dependent Medical applications or any application requiring high reliability where component failure could result in loss of life and/or property. For applications requiring high reliability and/or presenting an extreme operating environment, written consent and authorization from Abracon LLC is required. Please contact Abracon LLC for more information.



5101 Hidden Creek Ln Spicewood TX 78669
 Phone: 512-371-6159 | Fax: 512-351-8858
 For terms and conditions of sales, please visit:
www.abracon.com

REVISION A : 11/10/2021

ABRACON IS
 ISO9001-2015
 CERTIFIED

OUR CERTIFICATE

DiGi provide top-quality products and perfect service for customer worldwide through standardization, technological innovation and continuous improvement. DiGi through third-party certification, we stricly control the quality of products and services. Welcome your RFQ to

Email: Info@DiGi-Electronics.com



Tel: +00 852-30501935

RFQ Email: Info@DiGi-Electronics.com

DiGi is a global authorized distributor of electronic components.