

AXF6D2012A Datasheet

www.digi-electronics.com

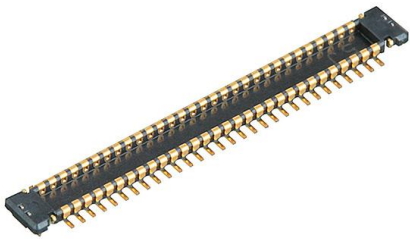

<https://www.DiGi-Electronics.com>

DiGi Electronics Part Number	AXF6D2012A-DG
Manufacturer	Panasonic Electric Works
Manufacturer Product Number	AXF6D2012A
Description	CONN HDR 20POS SMD GOLD
Detailed Description	20 Position Connector Header, Outer Shroud Contacts Surface Mount Gold

This model AXF6D2012A is available at DiGi Electronics.

DiGi Electronics offers a global database of semiconductor and electronic component datasheets.

We welcome your inquiries regarding pricing, lead time, or other product-related questions.

 [Request a Quote](#)

 [Datasheet Search](#)



Tel: +00 852-30501935

RFQ Email: Info@DiGi-Electronics.com

DiGi is a global authorized distributor of electronic components.

Purchase and inquiry

Manufacturer Product Number:

AXF6D2012A

Series:

A35UH

Connector Type:

Header, Outer Shroud Contacts

Pitch:

0.014" (0.35mm)

Mounting Type:

Surface Mount

Contact Finish:

Gold

Mated Stacking Heights:

0.6mm

Base Product Number:

AXF6D2012

Manufacturer:

Panasonic Electric Works

Product Status:

Active

Number of Positions:

20

Number of Rows:

2

Features:

Solder Retention

Contact Finish Thickness:

-

Height Above Board:

0.018" (0.46mm)

Environmental & Export classification

RoHS Status:

ROHS3 Compliant

ECCN:

EAR99

Moisture Sensitivity Level (MSL):

1 (Unlimited)

HTSUS:

8536.69.4040

High Current Connectors
【For board-to-FPC】

A35UH
(0.35 mm pitch)

Product Catalog

**IN Your
Future**

High current connectors 【For board-to-FPC】

RoHS

A35UH (0.35 mm pitch)

Supports 5 A for power terminal. Reduce number of pins is available.

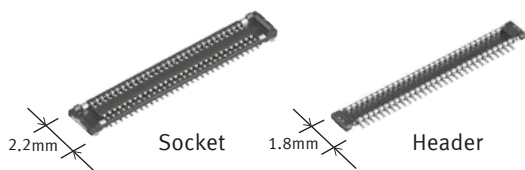

FEATURES

- Supports 5 A for power terminals
- With power terminal, so number of pins can be reduced
- " TOUGH CONTACT " construction provides high resistance to various environmental.

TYPICAL APPLICATIONS

- Smartphones, tablet PCs and other mobile devices

DETAILS FEATURES

- MAX. 5 A can be supplied to the power terminals. This allows for a reduction in the number of power line and contributes to space savings

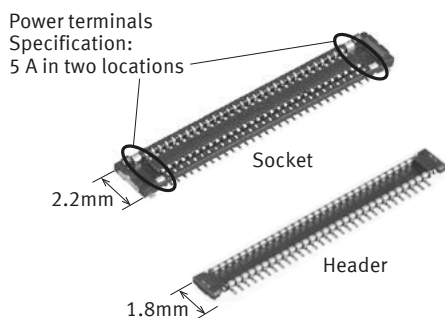

Example; Charging current: Max. 5 A (0.3 A/pin, Pitch: 0.35 mm)

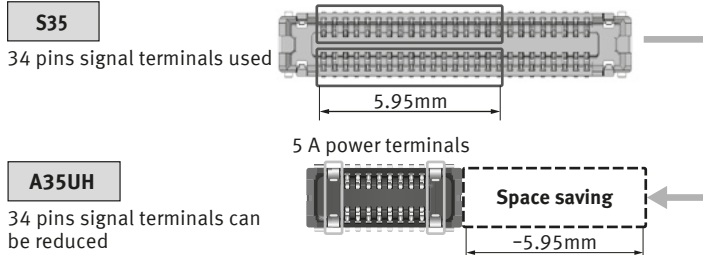

ORDERING INFORMATION (PART NO.)

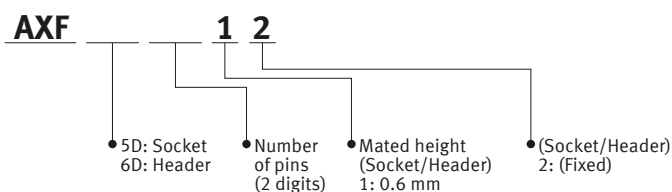

High current connectors A35UH (0.35 mm pitch)

PRODUCT TYPES

Mated height	Number of pins	Part No.		Standard packing	
		Socket	Header	Inner carton (1-reel)	Outer carton
0.6 mm	10	AXF5D1012	AXF6D1012	15,000 pcs.	30,000 pcs.
	12	AXF5D1212	AXF6D1212		
	16	AXF5D1612	AXF6D1612		
	20	AXF5D2012	AXF6D2012		
	24	AXF5D2412	AXF6D2412		
	30	AXF5D3012	AXF6D3012		
	34	AXF5D3412	AXF6D3412		
	40	AXF5D4012	AXF6D4012		
	44	AXF5D4412	AXF6D4412		
	50	AXF5D5012	AXF6D5012		
	54	AXF5D5412	AXF6D5412		
	60	AXF5D6012	AXF6D6012		
70	AXF5D7012	AXF6D7012			

Notes) 1: Order unit: For volume production: 1-inner carton (1-reel) units. For samples, please contact our sales representative.
2: Please contact our sales representative for connectors having a number of pins other than those listed above.

SPECIFICATIONS

Characteristics

Item		Specifications	Conditions																			
Electrical characteristics	Rated current	Power contact	5.0 A/pin contact																			
		Signal contact	0.3 A/pin contact (Max. 5 A at total pin contacts)																			
	Rated voltage		30 V AC/DC																			
	Dielectric strength		150 V AC for 1 min	No short-circuiting or damage at a detection current of 1 mA when the specified voltage is applied for one minute.																		
	Insulation resistance		Min. 1,000 M Ω (initial)	Using 250 V DC megger (applied for 1 min)																		
Contact resistance		Max. 30 m Ω (power terminal) Max. 90 m Ω (signal terminal)	Based on the contact resistance measurement method specified by JIS C 5402.																			
Mechanical characteristics	Composite insertion force		1.300 N/pin contact \times pin contacts																			
	Composite removal force		0.165 N/pin contact \times pin contacts																			
Environmental characteristics	Ambient temperature		-55 to +85 $^{\circ}$ C	Include the calorification from the connector. No icing. No condensation.																		
	Soldering heat resistance		The initial specification must be satisfied electrically and mechanically	Reflow soldering: Peak temperature: 260 $^{\circ}$ C or less (on the surface of the PC board around the connector terminals) Soldering iron: 300 $^{\circ}$ C within 5 sec., 350 $^{\circ}$ C within 3 sec.																		
	Storage temperature		-55 to +85 $^{\circ}$ C (product only) -40 to +50 $^{\circ}$ C (emboss packing)	No icing. No condensation.																		
	Thermal shock resistance (header and socket mated)		5 cycles, insulation resistance Min. 100 M Ω , contact resistance Max. 30 m Ω (power terminal) Max. 90 m Ω (signal terminal)	Conformed to MIL-STD-202F, method 107G <table border="1"> <thead> <tr> <th>Order</th> <th>Temperature ($^{\circ}$C)</th> <th>Time (minutes)</th> </tr> </thead> <tbody> <tr> <td>1</td> <td>-55$_{-3}^0$</td> <td>30</td> </tr> <tr> <td>2</td> <td>γ</td> <td>Max. 5</td> </tr> <tr> <td>3</td> <td>85$_{0}^{+3}$</td> <td>30</td> </tr> <tr> <td>4</td> <td>γ</td> <td>Max. 5</td> </tr> <tr> <td></td> <td>-55$_{-3}^0$</td> <td></td> </tr> </tbody> </table>	Order	Temperature ($^{\circ}$ C)	Time (minutes)	1	-55 $_{-3}^0$	30	2	γ	Max. 5	3	85 $_{0}^{+3}$	30	4	γ	Max. 5		-55 $_{-3}^0$	
	Order	Temperature ($^{\circ}$ C)	Time (minutes)																			
	1	-55 $_{-3}^0$	30																			
	2	γ	Max. 5																			
3	85 $_{0}^{+3}$	30																				
4	γ	Max. 5																				
	-55 $_{-3}^0$																					
Humidity resistance (header and socket mated)		120 hours, insulation resistance Min. 100 M Ω , contact resistance Max. 30 m Ω (power terminal) Max. 90 m Ω (signal terminal)	Conformed to IEC60068-2-78 Temperature 40 \pm 2 $^{\circ}$ C, humidity 90 to 95 % RH																			
Saltwater spray resistance (header and socket mated)		24 hours, insulation resistance Min. 100 M Ω , contact resistance Max. 30 m Ω (power terminal) Max. 90 m Ω (signal terminal)	Conformed to IEC60068-2-11 Temperature 35 \pm 2 $^{\circ}$ C, saltwater concentration 5 \pm 1 %																			
H ₂ S resistance (header and socket mated)		48 hours, contact resistance Max. 30 m Ω (power terminal) Max. 90 m Ω (signal terminal)	Temperature 40 \pm 2 $^{\circ}$ C, gas concentration 3 \pm 1 ppm, humidity 75 to 80 % RH																			
Lifetime characteristics	Insertion and removal life		30 times Repeated insertion and removal speed of Max. 200 times/hours																			
Unit weight		60 pins Socket : 0.02 g Header: 0.01 g																				

High current connectors A35UH (0.35 mm pitch)

Material and surface treatment

Part name	Material	Surface treatment
Molded portion	LCP resin (UL94V-0)	—
Contact and Post Power terminal	Copper alloy	Contact portion : Base: Ni plating, Surface: Au plating Terminal portion: Base: Ni plating, Surface: Au plating (except the terminal tips) The terminals close to the portion to be soldered have nickel barriers (exposed nickel portions) .

DIMENSIONS (Unit: mm)

CAD The CAD data of the products with a " CAD " mark can be downloaded from our Website.

Socket (Mated height: 0.6 mm)

CAD

External dimensions

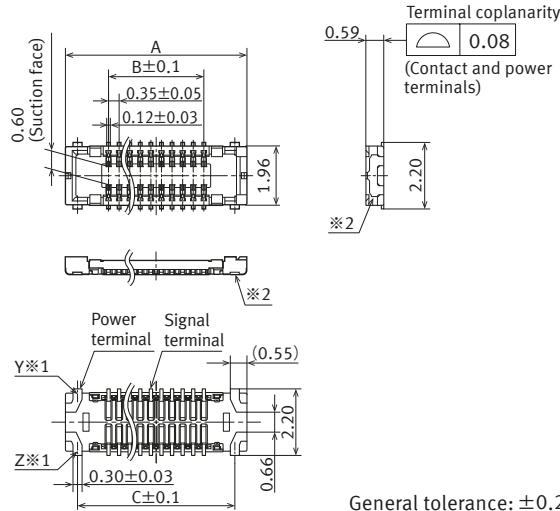
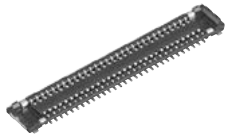

※1: Since power terminals are built into the body, the Y and Z parts are connected electrically.
 ※2: Excluding the terminal section, a difference may occur in the exposure of the power terminals.
 Please do not use this part for product inspection.

Dimension table

Number of pins	Dimensions		
	A	B	C
10	4.25	1.40	3.45
12	4.60	1.75	3.80
16	5.30	2.45	4.50
20	6.00	3.15	5.20
24	6.70	3.85	5.90
30	7.75	4.90	6.95
34	8.45	5.60	7.65
40	9.50	6.65	8.70
44	10.20	7.35	9.40
50	11.25	8.40	10.45
54	11.95	9.10	11.15
60	13.00	10.15	12.20
70	14.75	11.90	13.95

Header (Mated height: 0.6 mm)

CAD

External dimensions

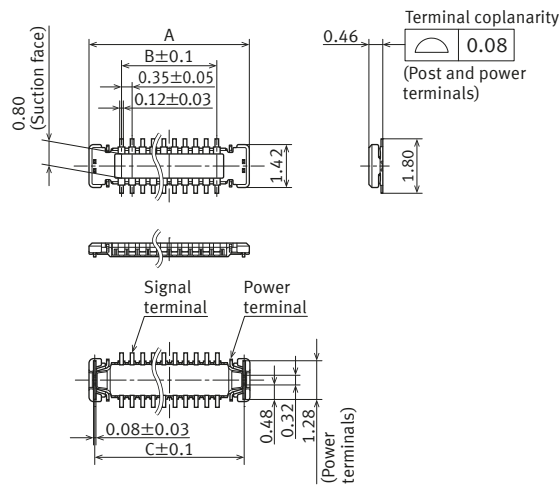

General tolerance: ±0.2

Dimension table

Number of pins	Dimensions		
	A	B	C
10	3.55	1.40	3.17
12	3.90	1.75	3.52
16	4.60	2.45	4.22
20	5.30	3.15	4.92
24	6.00	3.85	5.62
30	7.05	4.90	6.67
34	7.75	5.60	7.37
40	8.80	6.65	8.42
44	9.50	7.35	9.12
50	10.55	8.40	10.17
54	11.25	9.10	10.87
60	12.30	10.15	11.92
70	14.05	11.90	13.67

Socket and Header are mated

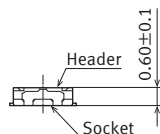

High current connectors A35UH (0.35 mm pitch)

EMBOSED TAPE DIMENSIONS (Unit: mm)

■ Specifications for taping

In accordance with JIS C 0806-3:1999. However, not applied to the mounting-hole pitch of some connectors.

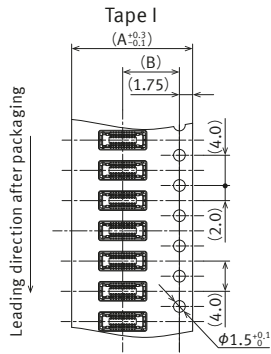

■ Specifications for the plastic reel

In accordance with EIAJ ET-7200B.

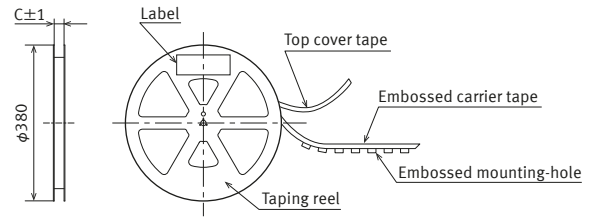

■ Dimension table

Type/Mated height	Number of pins	Type of taping	A	B	C	Quantity per reel
Socket 0.6 mm	Max. 30	Tape I	16.0	7.5	17.4	15,000
	34 to 70	Tape I	24.0	11.5	25.4	15,000
Type/Mated height	Number of pins	Type of taping	A	B	C	Quantity per reel
Header 0.6 mm	Max. 34	Tape I	16.0	7.5	17.4	15,000
	40 to 70	Tape I	24.0	11.5	25.4	15,000

■ Connector orientation with respect to embossed tape feeding direction

There is no indication on this product regarding top-bottom or left-right orientation.

Direction of tape progress	Type	Common for A35UH	
		Socket	Header
↓			

High current connectors A35UH (0.35 mm pitch)

NOTES (Unit: mm)

■ Design of PC board patterns

Conduct the recommended foot pattern design, in order to preserve the mechanical strength of terminal solder areas.

■ Recommended PC board and metal mask patterns

Connectors are mounted with high pitch density, intervals of 0.35 mm, 0.4 mm or 0.5 mm. In order to reduce solder and flux rise, solder bridges and other issues make sure the proper levels of solder is used.

The figures are recommended patterns. Please use them as a reference.

■ Socket (Mated height: 0.6 mm)

● Recommended PC board pattern (TOP VIEW)

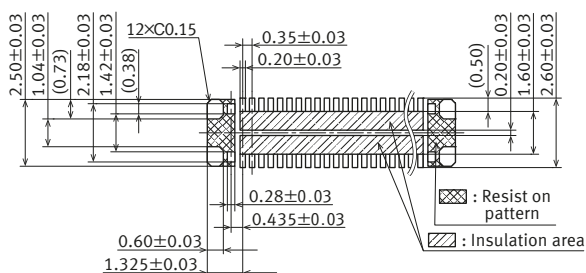

● Recommended metal mask pattern

Metal mask thickness: When 100 μm
(Terminal opening ratio : 70 %)
(Metal-part opening ratio: 46 %)

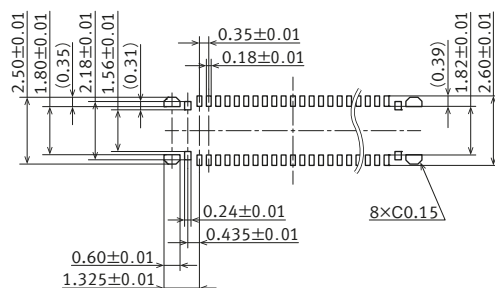

■ Header (Mated height: 0.6 mm)

● Recommended PC board pattern (TOP VIEW)

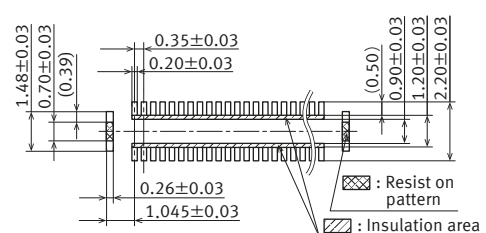

● Recommended metal mask pattern

Metal mask thickness: When 100 μm
(Signal terminal opening ratio: 70 %)
(Power terminal opening ratio: 77 %)

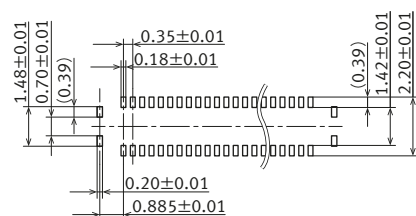

Please refer to "the latest product specifications" when designing your product.

• Requests to customers:

<https://industrial.panasonic.com/ac/e/salespolicies/>

About safety remarks

Observe the following safety remarks to prevent accidents and injuries.

- Do not use these connectors beyond the specification sheets. The usage outside of specified rated current, dielectric strength, and environmental conditions and so on may cause circuitry damage via abnormal heating, smoke, and fire.
- In order to avoid accidents, your thorough specification review is appreciated. Please contact our sales representative if your usage is out of the specifications. Otherwise, Panasonic Industry Co., Ltd. cannot guarantee the quality and reliability.
- Panasonic Industry Co., Ltd. is consistently striving to improve quality and reliability. However, the fact remains that electrical components and devices generally cause failures at a given statistical probability. Furthermore, their durability varies with use environments or use conditions. In this respect, please check for actual electrical components and devices under actual conditions before use. Continued usage in a state of degraded condition may cause the deteriorated insulation, thus result in abnormal heat, smoke or firing. Please carry out safety design and periodic maintenance including redundancy design, design for fire spread prevention, and design for malfunction prevention so that no accidents resulting in injury or death, fire accidents, or social damage will be caused as a result of failure of the products or ending life of the products.

Regarding the design of devices and PC board patterns

- When using board to board connectors, a pair of board shall NOT be connected with multiple connectors. Otherwise, misaligned connector positions may cause mating failure or product breakage. Panasonic Industry Co., Ltd. does not guarantee the failures caused by using the multiple connectors.
- With mounting equipment, there may be up to a ± 0.2 to 0.3 mm error in positioning. Be sure to design PC boards and patterns while taking into consideration the performance and abilities of the required equipment.
- Some connectors have tabs embossed on the body to aid in positioning. When using these connectors, make sure that the PC board is designed with positioning holes to match these tabs.
- To ensure the required mechanical strength when soldering the connector terminals, make sure the PC board meets recommended PC board pattern design dimensions given.
- PC board
Control the thicknesses of the cover lay and adhesive to prevent poor soldering. This connector has no stand-off. Therefore, minimize the thickness of the cover lay, etc. so as to prevent the occurrence of poor soldering.
- For all connectors of the narrow pitch series, to prevent the PC board from coming off during vibrations or impacts, and to prevent loads from falling directly on the soldered portions, be sure to design some means to fix the PC board in place.

Example) Secure in place with screws

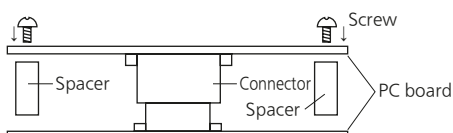

When connecting PC boards, take appropriate measures to prevent the connector from coming off.

Notes on Using Narrow pitch RF Connectors/Narrow pitch Connectors/High Current Connectors

Regarding the selection of the connector placement machine and the mounting procedures

- Select the placement machine taking into consideration the connector height, required positioning accuracy, and packaging conditions.
- Be aware that if the chucking force of the placement machine is too great, it may deform the shape of the connector body or connector terminals.
- Be aware that during mounting, external forces may be applied to the connector contact surfaces and terminals and cause deformations.
- Depending on the size of the connector being used, self alignment may not be possible. In such cases, be sure to carefully position the terminal with the PC board pattern.
- The positioning bosses give an approximate alignment for positioning on the PC board. For accurate positioning of the connector when mounting it to the PC board, we recommend using an automatic positioning machine.
- In case of dry condition, please note the occurrence of static electricity. The product may be adhered to the embossed carrier tape or the cover tape in dry condition. Recommended humidity is from 40 to 60 % RH and please remove static electricity by ionizer in manufacturing process.

Regarding soldering

Reflow soldering

- Measure the recommended profile temperature for reflow soldering by placing a sensor on the PC board near the connector surface or terminals. (Please refer to the specification for detail because the temperature setting differs by products.)
- As for cream solder printing, screen printing is recommended.
- When setting the screen opening area and PC board foot pattern area, refer the recommended PC board pattern and window size of metal mask on the specification sheet, and make sure that the size of board pattern and metal mask at the base of the terminals are not increased.
- Please pay attentions not to provide too much solder. It makes miss mating because of interference at soldering portion when mating.

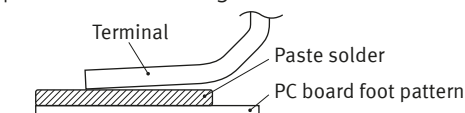

- When mounting on both sides of the PC board and the connector is mounting on the underside, use adhesives or other means to ensure the connector is properly fixed to the PC board. (Double reflow soldering on the same side is possible.)
- The condition of solder or flux rise and wettability varies depending on the type of solder and flux. Solder and flux characteristics should be taken into consideration and also set the reflow temperature and oxygen level.

- Do not use resin-containing solder. Otherwise, the contacts might be firmly fixed.
- Soldering conditions
Please use the reflow temperature profile conditions recommended below for reflow soldering. Please contact our sales representative before using a temperature profile other than that described below.

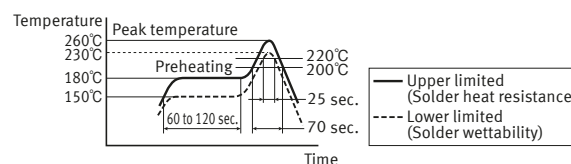

For products other than the ones above, please refer to the latest product specifications.

- The temperature profiles given in this catalog are values measured when using the connector on a resin-based PC board. When performed reflow soldering on a metal board (iron, aluminum, etc.) or a metal table to mount on a FPC, make sure there is no deformation or discoloration of the connector before mounting.
- Please contact our sales representative when using a screen-printing thickness other than that recommended.

Notes on Using Narrow pitch RF Connectors/Narrow pitch Connectors/High Current Connectors

■ Hand soldering

- Set the soldering iron so that the tip temperature is less than that given in the table below.

Table A

Product name	Soldering iron temperature
SMD type connectors all products	300°C within 5 sec. 350°C within 3 sec.

- Do not allow flux to spread onto the connector leads or PC board. This may lead to flux rising up to the connector inside.
- Touch the soldering iron to the foot pattern. After the foot pattern and connector terminal are heated, apply the solder wire so it melts at the end of the connector terminals.

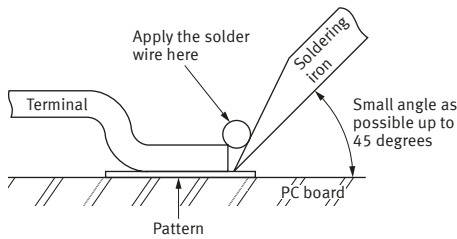

- Be aware that soldering while applying a load on the connector terminals may cause improper operation of the connector.
- Thoroughly clean the soldering iron.
- Flux from the solder wire may get on the contact surfaces during soldering operations. After soldering, carefully check the contact surfaces and clean off any solder before use.
- These connector is low profile type. If too much solder is supplied for hand soldering, It makes miss mating because of interference at soldering portion. Please pay attentions.

■ Solder reworking

- Finish reworking in one operation.
- In case of soldering rework of bridges. Do not use supplementary solder flux. Doing so may cause contact problems by flux.
- Keep the soldering iron tip temperature below the temperature given in Table A.

Handling single components

- Make sure not to drop or allow parts to fall from work bench.
- Excessive force applied to the terminals could cause warping, come out, or weaken the adhesive strength of the solder. Handle with care.
- Do not insert or remove the connector when it is not soldered. Forcibly applied external pressure on the terminals can weaken the adherence of the terminals to the molded part or cause the terminals to lose their evenness.

Precautions for mating

This product is designed with ease of handling. However, in order to prevent the deformation or damage of contacts and molding, take care and do not mate the connectors as shown right.

Our products are symmetrical structure. Please avoid reverse insertion of connector. Inserting a connector in a circuit direction opposite to that you intended may cause circuitry damage via abnormal heating, smoke, and fire.

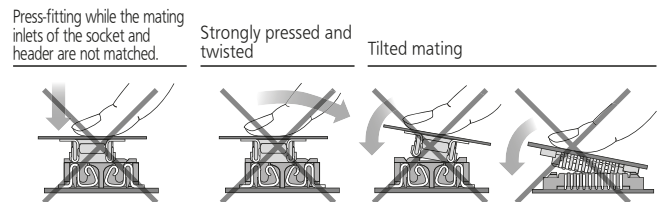

Cleaning flux from PC board

There is no need to clean this product. If cleaning it, pay attention to the following points to prevent the negative effect to the product.

- Keep the cleaning solvent clean and prevent the connector contacts from contamination.
- Some cleaning solvents are strong and they may dissolve the molded part and characters, so pure water passed liquid solvent is recommended.

Notes on Using Narrow pitch RF Connectors/Narrow pitch Connectors/High Current Connectors

Handling the PC board

■ Handling the PC board after mounting the connector

When cutting or bending the PC board after mounting the connector, be careful that the soldered sections are subjected to excessive force.

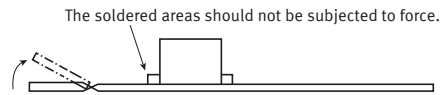

Storage of connectors

- To prevent problems from voids or air pockets due to heat of reflow soldering, avoid storing the connectors in areas of high humidity.
- Depending on the connector type, the color of the connector may vary from connector to connector depending on when it is produced. Some connectors may change color slightly if subjected to ultraviolet rays during storage. This is normal and will not affect the operation of the connector.
- When storing the connectors with the PC boards assembled and components already set, be careful not to stack them up so the connectors are subjected to excessive forces.
- Avoid storing the connectors in locations with excessive dust. The dust may accumulate and cause improper connections at the contact surfaces.

Other Notes

- Do not remove or insert the electrified connector (in the state of carrying current or applying voltage).
- Dropping of the products or rough mishandling may bend or damage the terminals and possibly hinder proper reflow soldering.
- Before soldering, try not to insert or remove the connector more than absolutely necessary.
- When coating the PC board after soldering the connector to prevent the deterioration of insulation, perform the coating in such a way so that the coating does not get on the connector.
- There may be variations in the colors of products from different production lots. This is normal.
- The connectors are not meant to be used for switching.
- Product failures due to condensation are not covered by warranty.

Regarding sample orders to confirm proper mounting

When ordering samples to confirm proper mounting with the placement machine, connectors are delivered in 50-piece units in the condition given right. Consult a sale representative for ordering sample units.

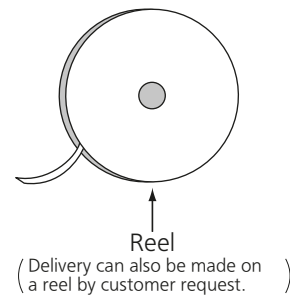
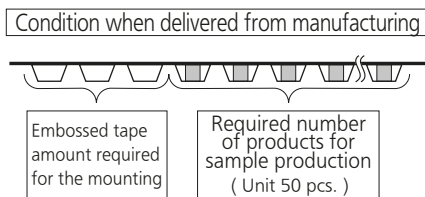

Please refer to "the latest product specifications" when designing your product.

- Requests to customers:

<https://industrial.panasonic.com/ac/e/salespolicies/>

■ Global Sales Network Information: industrial.panasonic.com/ac/e/salesnetwork

Panasonic
INDUSTRY

Panasonic Industry Co., Ltd.

Electromechanical Control Business Division

■ 1006, Oaza Kadoma, Kadoma-shi, Osaka 571-8506, Japan
industrial.panasonic.com/ac/e/

OUR CERTIFICATE

DiGi provide top-quality products and perfect service for customer worldwide through standardization, technological innovation and continuous improvement. DiGi through third-party certification, we stricly control the quality of products and services. Welcome your RFQ to

Email: Info@DiGi-Electronics.com



Tel: +00 852-30501935

RFQ Email: Info@DiGi-Electronics.com

DiGi is a global authorized distributor of electronic components.