

# ELJ-NDR10JF Datasheet

[www.digi-electronics.com](http://www.digi-electronics.com)



<https://www.DiGi-Electronics.com>

DiGi Electronics Part Number	ELJ-NDR10JF-DG
Manufacturer	<a href="#">Panasonic Electronic Components</a>
Manufacturer Product Number	ELJ-NDR10JF
Description	FIXED IND 100NH 285MA 860MOHM SM
Detailed Description	100 nH Unshielded Wirewound Inductor 285 mA 860mOhm Max 0805 (2012 Metric)

This model ELJ-NDR10JF is available at DiGi Electronics.

DiGi Electronics offers a global database of semiconductor and electronic component datasheets.

We welcome your inquiries regarding pricing, lead time, or other product-related questions.

 [Request a Quote](#)

 [Datasheet Search](#)



Tel: +00 852-30501935

RFQ Email: [Info@DiGi-Electronics.com](mailto:Info@DiGi-Electronics.com)

DiGi is a global authorized distributor of electronic components.

## Purchase and inquiry

Manufacturer Product Number:

ELJ-NDR10JF

Series:

ND

Type:

Wirewound

Inductance:

100 nH

Current Rating (Amps):

285 mA

Shielding:

Unshielded

Q @ Freq:

8 @ 25.2MHz

Ratings:

-

Inductance Frequency - Test:

25.2 MHz

Package / Case:

0805 (2012 Metric)

Size / Dimension:

0.079" L x 0.049" W (2.00mm x 1.25mm)

Base Product Number:

ELJ-NDR

Manufacturer:

Panasonic Electronic Components

Product Status:

Obsolete

Material - Core:

Non-Magnetic

Tolerance:

±5%

Current - Saturation (Isat):

-

DC Resistance (DCR):

860mOhm Max

Frequency - Self Resonant:

800MHz

Operating Temperature:

-20°C ~ 85°C

Mounting Type:

Surface Mount

Supplier Device Package:

0805 (2012 Metric)

Height - Seated (Max):

0.057" (1.45mm)

## Environmental & Export classification

Moisture Sensitivity Level (MSL):

1 (Unlimited)

HTSUS:

8504.50.8000

ECCN:

EAR99

**1. High Frequency Use (Non Magnetic Core) RF, RE, ND, NC, NA**



**Features**

- High frequency capability due to its non magnetic core.
- Capable of being Re-flow or flow soldered.
- Wide line-up from 1005 to 3225 case sizes.
- Good for mounting.
- RoHS compliant

Wire wound ELJND, ELJNC, ELJNA  
 • Planed final order receiving:October.2014  
 • Planed final production:September.2015  
 Non wound ELJRF, ELJRE  
 • Planed final order receiving:March.2016  
 • laned final production:March.2017

**Recommended Applications**

- RF circuitry for cellular phones and wireless communication equipment.

**Explanation of Part Numbers**

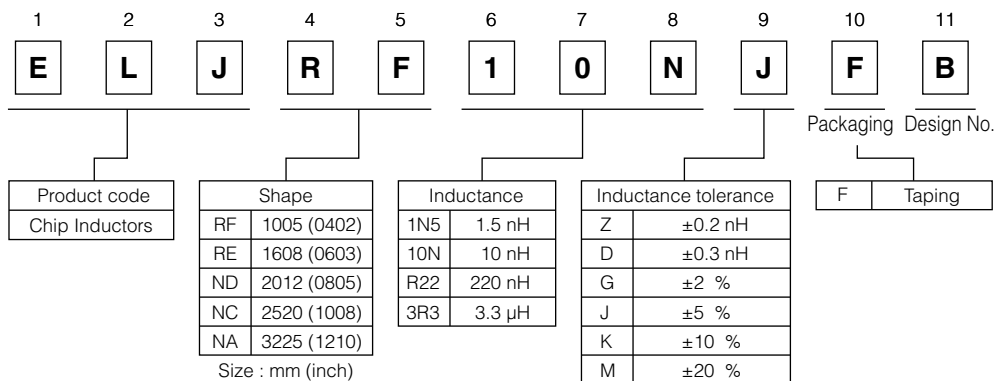

**Storage Conditions**

- Package : Normal temperature (-5 to 35 °C), normal humidity (85 %RH max.), shall not be exposed to direct sunlight and harmful gases and care should be taken so as not to cause dew.
- Operating Temperature : -40 to +85 °C (RF, RE)  
 -20 to +85 °C (ND, NC, NA)

**Storage Period**

- Solderability may be reduced due to the conditions of high temperature and high humidity which causes the oxidation of tin-plated terminals. Even if storage conditions are within specified limits, solderability may be reduced with the passage of time. Therefore, please control the storage conditions and try to use the product within 6 months of receipt.

**Packaging Methods, Soldering Conditions and Safety Precautions**

Please see Data Files.

■ RF Type 1005 (0402)

● Dimensions in mm (not to scale)

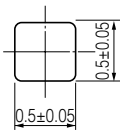
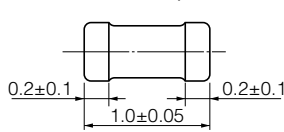

● Recommended Land Pattern in mm (not to scale)

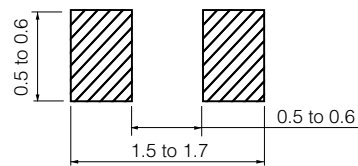

■ Standard Packing Quantity

● 10000 pcs./Reel

■ Standard Parts (E12 series)

Part No.	Inductance			Q		SRF *1 (MHz) min.	R <sub>DC</sub> *2 (Ω) max.	DC Current (mA) max.
	(nH)	Tolerance (%)	Test Freq. (MHz)	min.	Test Freq. (MHz)			
ELJRF1N0□FB	1.0	D : ±0.3 nH Z : ±0.2 nH	100	8	100	6000	0.05	400
ELJRF1N2□FB	1.2					6000	0.06	400
ELJRF1N5□FB	1.5					6000	0.07	400
ELJRF1N8□FB	1.8					6000	0.08	400
ELJRF2N2□FB	2.2					6000	0.09	400
ELJRF2N7□FB	2.7					5500	0.10	400
ELJRF3N3□FB	3.3					5500	0.12	400
ELJRF3N9□FB	3.9					5200	0.15	360
ELJRF4N7□FB	4.7					4800	0.17	360
ELJRF5N6□FB	5.6					4600	0.19	340
ELJRF6N8□FB	6.8	J : ±5 % G : ±2 %	100	8	100	4000	0.30	320
ELJRF8N2□FB	8.2					3500	0.35	320
ELJRF10N□FB	10					2800	0.41	320
ELJRF12N□FB	12					2800	0.45	320
ELJRF15N□FB	15					2500	0.60	240
ELJRF18N□FB	18					2200	0.70	240
ELJRF22N□FB	22					2000	0.80	200
ELJRF27N□FB	27					1800	1.20	200
ELJRF33N□FB	33					1800	1.40	170
ELJRF39N□FB	39					1800	1.70	150
ELJRF47N□FB	47	1800	2.10	140				
ELJRF56N□FB	56	1500	2.50	130				
ELJRF68N□FB	68	1500	4.00	120				
ELJRF82N□FB	82	1400	4.50	110				
ELJRFR10□FB	100	1200	5.50	90				

□ : Symbol of Tolerance \*1 : Self Resonant Frequency \*2 : DC Resistance

■ Standard Parts (E24 series)

Part No.	Inductance			Q		SRF *1 (MHz) min.	R <sub>DC</sub> *2 (Ω) max.	DC Current (mA) max.
	(nH)	Tolerance (%)	Test Freq. (MHz)	min.	Test Freq. (MHz)			
ELJRF2N0□FB	2.0	D : ±0.3 nH Z : ±0.2 nH	100	8	100	6000	0.08	400
ELJRF2N4□FB	2.4					6000	0.09	400
ELJRF3N0□FB	3.0					5500	0.11	400
ELJRF3N6□FB	3.6					5300	0.14	380
ELJRF4N3□FB	4.3					5000	0.16	360
ELJRF5N1□FB	5.1					4700	0.18	350
ELJRF6N2□FB	6.2	J : ±5 % G : ±2 %	100	8	100	4300	0.25	330
ELJRF7N5□FB	7.5					3700	0.33	320
ELJRF9N1□FB	9.1					3100	0.38	320
ELJRF11N□FB	11					2800	0.43	320
ELJRF13N□FB	13					2600	0.53	280
ELJRF16N□FB	16					2300	0.65	240
ELJRF20N□FB	20					2100	0.75	220
ELJRF24N□FB	24					1900	1.00	200
ELJRF30N□FB	30					1800	1.30	190
ELJRF36N□FB	36					1800	1.60	160
ELJRF43N□FB	43	1800	1.90	150				

□ : Symbol of Tolerance \*1 : Self Resonant Frequency \*2 : DC Resistance

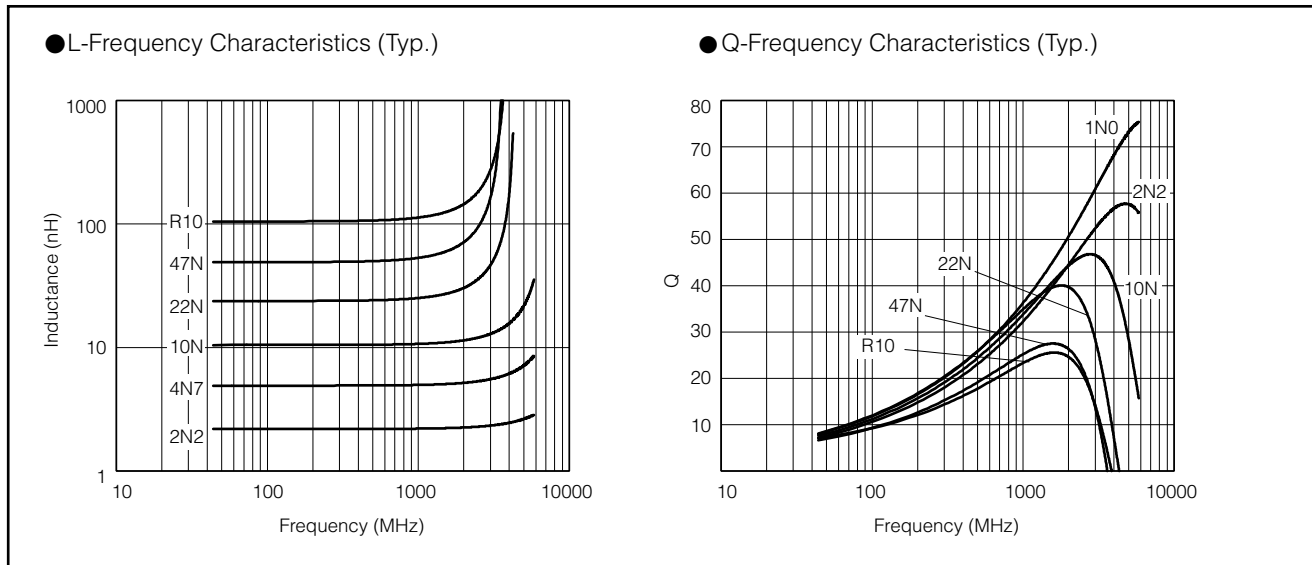
**■ ELJRF Type**
**■ Typical Characteristics**

**■ Reference Date**

Part No	Inductance (nH)(Typ.)					Q(Typ.)				
	800MHz	900MHz	1.8GHz	2.0GHz	2.4GHz	800MHz	900MHz	1.8GHz	2.0GHz	2.4GHz
ELJRF1N0□FB	0.95	0.95	0.96	0.96	0.97	31.8	33.8	47.2	49.6	54.0
ELJRF1N2□FB	1.23	1.24	1.24	1.25	1.25	31.0	33.0	43.4	45.6	49.7
ELJRF1N5□FB	1.51	1.51	1.53	1.53	1.54	32.9	34.9	48.6	50.9	55.4
ELJRF1N8□FB	1.85	1.85	1.87	1.88	1.90	31.1	33.1	45.9	48.1	52.1
ELJRF2N2□FB	2.11	2.12	2.15	2.16	2.19	28.3	30.1	41.6	43.6	47.2
ELJRF2N7□FB	2.63	2.63	2.68	2.70	2.73	28.0	28.7	39.6	41.4	44.7
ELJRF3N3□FB	3.27	3.28	3.35	3.37	3.42	29.9	31.7	43.7	45.7	49.2
ELJRF3N9□FB	3.73	3.74	3.82	3.85	3.91	29.7	31.5	43.4	45.4	48.8
ELJRF4N7□FB	4.77	4.78	4.92	4.96	5.07	33.9	35.9	49.0	51.1	54.6
ELJRF5N6□FB	5.70	5.70	5.80	5.90	6.20	30.0	31.0	40.0	41.0	42.8
ELJRF6N8□FB	6.91	6.93	7.21	7.29	7.51	28.9	30.7	41.3	42.7	45.0
ELJRF8N2□FB	8.31	8.33	8.73	8.86	9.19	31.0	32.9	43.9	45.3	47.4
ELJRF10N□FB	10.21	10.25	10.77	10.94	11.37	29.8	31.6	42.1	43.5	45.6
ELJRF12N□FB	12.3	12.3	13.1	13.3	14.0	30.8	32.6	42.9	44.1	45.4
ELJRF15N□FB	15.3	15.4	16.5	16.9	17.9	28.8	30.4	39.5	40.4	41.2
ELJRF18N□FB	18.4	18.6	20.2	20.8	22.3	31.1	32.8	41.6	42.1	41.7
ELJRF22N□FB	23.7	23.9	27.5	28.8	32.5	31.3	32.9	39.6	39.4	37.2
ELJRF27N□FB	28.3	28.5	32.8	34.4	38.8	28.4	29.9	36.0	35.8	33.7
ELJRF33N□FB	34.6	35.1	43.4	46.8	57.5	28.4	29.7	33.7	32.9	29.2
ELJRF39N□FB	40.8	41.4	49.9	53.2	63.3	25.6	26.9	31.1	30.5	27.5
ELJRF47N□FB	49.6	50.3	62.1	66.8	81.8	22.7	23.8	26.9	26.2	23.2
ELJRF56N□FB	58.4	59.1	69.9	74.1	86.2	23.8	25.0	28.9	28.3	25.6
ELJRF68N□FB	71.9	72.9	90.4	97.5	119.9	22.3	23.3	25.4	24.3	20.4
ELJRF82N□FB	86.6	87.8	107.8	115.7	140.6	21.9	22.9	25.5	24.6	21.3
ELJRFR10□FB	105.5	106.8	128.2	136.5	161.3	21.0	21.9	25.0	24.4	21.9

□ : Symbol of Tolerance

■ RE Type 1608 (0603)

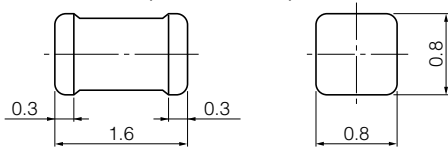
● Dimensions in mm (not to scale)



● Recommended Land Pattern in mm (not to scale)

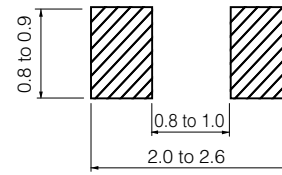

■ Standard Packing Quantity

● 3000 pcs./Reel

■ Standard Parts (E12 series)

Part No.	Inductance			Q		SRF *1 (MHz) min.	R <sub>bc</sub> *2 (Ω) max.	DC Current (mA) max.
	(nH)	Tolerance (%)	Test Freq. (MHz)	min.	Test Freq. (MHz)			
ELJRE1N0□FA	1.0	D : ±0.3 nH	Z : ±0.2 nH	100	100	6000	0.05	500
ELJRE1N2□FA	1.2							
ELJRE1N5□FA	1.5							
ELJRE1N8□FA	1.8							
ELJRE2N2□FA	2.2							
ELJRE2N7□FA	2.7							
ELJRE3N3□FA	3.3							
ELJRE3N9□FA	3.9	J : ±5 %	G : ±2 %	100	100	5500	0.15	450
ELJRE4N7□FA	4.7							
ELJRE5N6□FA	5.6							
ELJRE6N8□FA	6.8							
ELJRE8N2□FA	8.2							
ELJRE10N□FA	10							
ELJRE12N□FA	12							
ELJRE15N□FA	15							
ELJRE18N□FA	18							
ELJRE22N□FA	22							
ELJRE27N□FA	27							
ELJRE33N□FA	33							
ELJRE39N□FA	39	100	25.2	25.2	1200	3.00	130	
ELJRE47N□FA	47							
ELJRE56N□FA	56							
ELJRE68N□FA	68							
ELJRE82N□FA	82							
ELJRER10□FA	100							
ELJRER12□FA	120	25.2	25.2	25.2	1100	4.50	100	
ELJRER15□FA	150							
ELJRER18□FA	180							
ELJRER22□FA	220							

□ : Symbol of Tolerance \*1 : Self Resonant Frequency \*2 : DC Resistance

■ ELJRE Type

■ Typical Characteristics

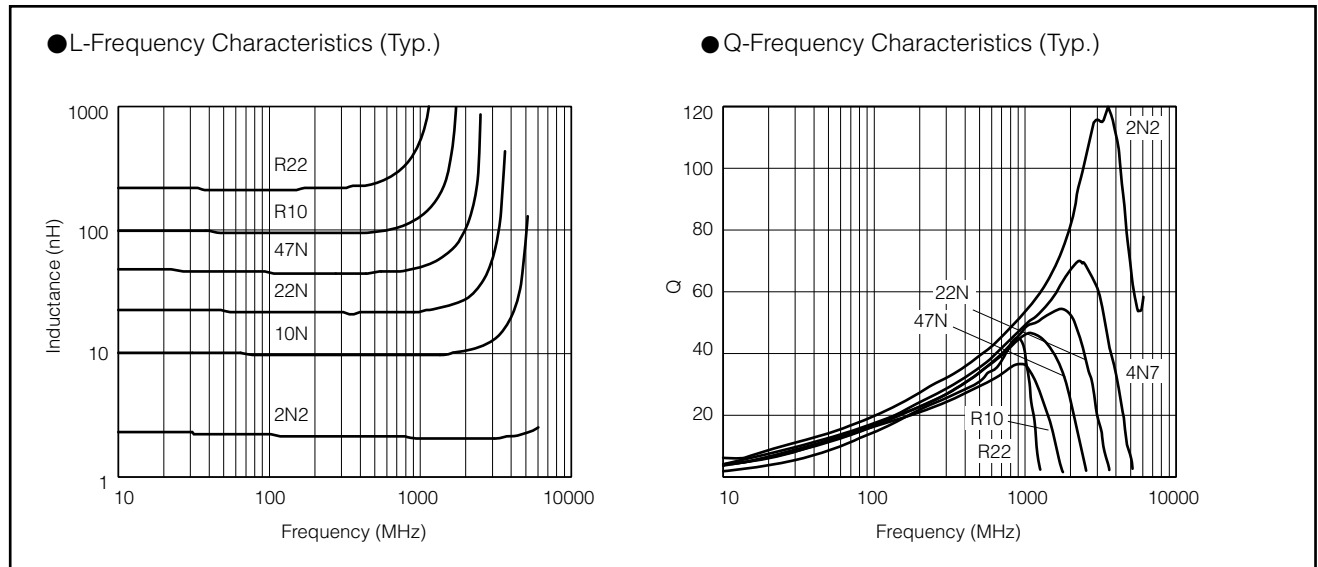

■ Reference Date

Part No	Inductance (nH)(Typ.)					Q(Typ.)				
	800MHz	900MHz	1.8GHz	2.0GHz	2.4GHz	800MHz	900MHz	1.8GHz	2.0GHz	2.4GHz
ELJRE1N0□FA	1.01	1.01	0.99	0.98	0.98	71.2	76.8	116.8	129.6	155.8
ELJRE1N2□FA	1.19	1.19	1.18	1.17	1.17	65.1	69.8	102.7	113.9	136.9
ELJRE1N5□FA	1.41	1.41	1.39	1.39	1.38	52.7	56.2	79.6	88.0	103.3
ELJRE1N8□FA	1.86	1.86	1.84	1.84	1.84	55.9	59.6	86.7	97.5	117.0
ELJRE2N2□FA	2.10	2.09	2.07	2.07	2.07	48.6	51.3	74.8	83.6	98.6
ELJRE2N7□FA	2.59	2.59	2.58	2.59	2.60	48.6	51.3	71.1	78.1	89.9
ELJRE3N3□FA	3.09	3.08	3.08	3.09	3.11	49.6	52.7	78.5	88.6	105.8
ELJRE3N9□FA	3.61	3.61	3.63	3.65	3.69	50.2	53.0	70.5	77.1	87.0
ELJRE4N7□FA	4.42	4.42	4.48	4.52	4.60	46.3	49.4	69.4	76.6	86.1
ELJRE5N6□FA	5.39	5.39	5.49	5.55	5.66	49.5	52.8	75.4	84.0	94.3
ELJRE6N8□FA	6.59	6.60	6.79	6.89	7.08	49.3	52.8	78.1	86.7	97.0
ELJRE8N2□FA	7.97	7.99	8.33	8.51	8.83	49.0	52.4	75.4	82.6	89.1
ELJRE10N□FA	9.60	9.63	10.22	10.51	11.07	44.2	47.0	63.4	68.0	69.7
ELJRE12N□FA	11.7	11.8	12.7	13.2	14.1	44.6	47.7	64.7	68.5	67.8
ELJRE15N□FA	14.6	14.6	16.2	17.1	18.7	42.4	45.4	58.4	59.5	56.9
ELJRE18N□FA	17.6	17.8	20.2	21.5	24.2	45.9	49.4	64.6	65.0	58.8
ELJRE22N□FA	21.7	21.9	26.0	28.3	33.3	43.0	45.8	54.2	52.2	43.8
ELJRE27N□FA	27.2	27.6	34.6	38.9	49.3	43.9	47.0	52.4	49.2	38.1
ELJRE33N□FA	33.3	33.9	45.5	53.2	75.2	41.8	44.4	45.2	39.3	26.2
ELJRE39N□FA	39.8	40.7	58.6	71.9	117.0	42.2	44.9	40.4	33.1	18.8
ELJRE47N□FA	48.3	49.6	79.8	107.1	260.7	42.6	45.3	34.1	24.0	8.8
ELJRE56N□FA	59.2	61.1	112.8	176.3	735.5	42.0	44.5	25.1	15.2	0.8
ELJRE68N□FA	73.9	77.0	185.9	459.7		41.8	44.0	21.5	9.5	
ELJRE82N□FA	94.0	99.6	494.3			39.7	41.5	7.7		
ELJRER10□FA	115.2	123.5	2141.2			35.3	36.7	1.6		
ELJRER12□FA	143.4	156.9				35.2	35.7			
ELJRER15□FA	188.5	210.6				40.6	41.5			
ELJRER18□FA	242.9	280.4				39.0	39.8			
ELJRER22□FA	337.9	416.6				43.2	45.3			

□ : Symbol of Tolerance

■ ND Type 2012 (0805)

● Dimensions in mm (not to scale)

● Recommended Land Pattern in mm (not to scale)

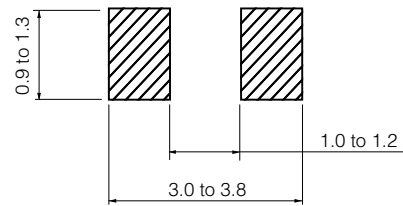
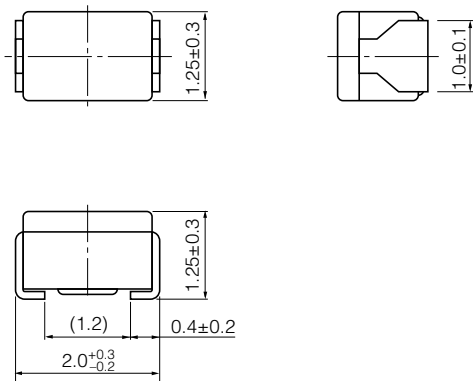

■ Standard Packing Quantity

● 3000 pcs./Reel

■ Standard Parts

Part No.	Inductance			Q		SRF *1 (MHz) min.	R <sub>DC</sub> *2 (Ω) max.	DC Current (mA) max.			
	(nH)	Tolerance (%)	Test Freq. (MHz)	min.	Test Freq. (MHz)						
ELJND10N□F	10	K : ±10 %	100	10	100	3300	0.18	540			
ELJND12N□F	12					3300	0.24	535			
ELJND15N□F	15					3000	0.24	520			
ELJND18N□F	18					3000	0.29	480			
ELJND22N□F	22					2600	0.29	465			
ELJND27N□F	27					2500	0.34	455			
ELJND33N□F	33			K : ±10 % or J : ±5 %		25.2	15	25.2	2050	0.39	395
ELJND39N□F	39								2000	0.41	390
ELJND47N□F	47								1650	0.46	385
ELJND56N□F	56								1550	0.51	360
ELJND68N□F	68								1450	0.57	340
ELJND82N□F	82								1100	0.63	330
ELJNDR10□F	100	K : ±10 % or J : ±5 %	25.2		8		25.2		800	0.86	285
ELJNDR12□F	120								600	0.99	275
ELJNDR15□F	150								600	1.47	230
ELJNDR18□F	180								600	1.61	195
ELJNDR22□F	220								500	1.84	170
ELJNDR27□F	270								300	1.95	165
ELJNDR33□F	330			200	2.16	160					
ELJNDR39□F	390			150	2.37	150					
ELJNDR47□F	470			150	2.56	145					
ELJNDR56□F	560			100	2.69	140					
ELJNDR68□F	680			100	3.02	130					
ELJNDR82□F	820			80	3.38	125					
ELJND1R0□F	1000	7.96	8	7.96	80	3.88	120				

□ : Symbol of Tolerance \*1 : Self Resonant Frequency \*2 : DC Resistance

■ NC Type 2520 (1008)

● Dimensions in mm (not to scale)

● Recommended Land Pattern in mm (not to scale)

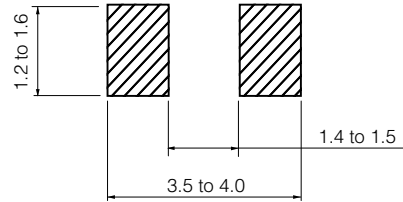
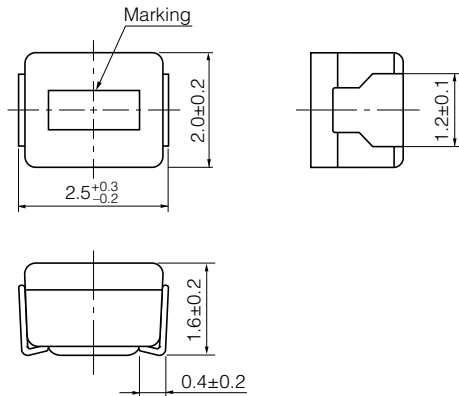

■ Standard Packing Quantity

● 2000 pcs./Reel

■ Standard Parts

Part No.	Inductance			Q		SRF *1 (MHz) min.	R <sub>DC</sub> *2 (Ω) max.	DC Current (mA) max.
	(nH)	Tolerance (%)	Test Freq. (MHz)	min.	Test Freq. (MHz)			
ELJNC10N□F	10	K : ±10 %	100	10	100	2500	0.32	280
ELJNC12N□F	12					2200	0.34	270
ELJNC15N□F	15					1800	0.38	255
ELJNC18N□F	18					1550	0.40	250
ELJNC22N□F	22					1350	0.43	240
ELJNC27N□F	27			1150		0.47	230	
ELJNC33N□F	33			1000		0.51	220	
ELJNC39N□F	39			890		0.55	215	
ELJNC47N□F	47			770		0.59	205	
ELJNC56N□F	56			670		0.63	200	
ELJNC68N□F	68	590	0.68	190				
ELJNC82N□F	82	520	0.73	185				
ELJNCR10□F	100	K : ±10 % or J : ±5 %	25.2	10	25.2	460	0.80	175
ELJNCR12□F	120					400	0.87	170
ELJNCR15□F	150					340	0.98	160
ELJNCR18□F	180					300	1.05	155
ELJNCR22□F	220					260	1.15	145
ELJNCR27□F	270					230	1.25	140
ELJNCR33□F	330					200	1.37	135
ELJNCR39□F	390					180	1.47	130
ELJNCR47□F	470					160	1.58	125
ELJNCR56□F	560					145	1.70	120
ELJNCR68□F	680	130	1.85	110				
ELJNCR82□F	820	100	2.10	100				

□ : Symbol of Tolerance \*1 : Self Resonant Frequency \*2 : DC Resistance

## ■ NA Type 3225 (1210)

### ● Dimensions in mm (not to scale)

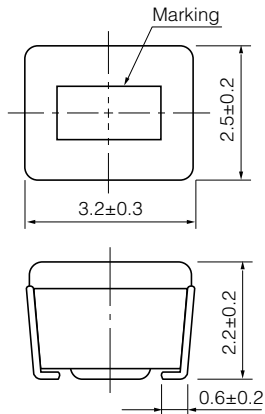

### ● Recommended Land Pattern in mm (not to scale)

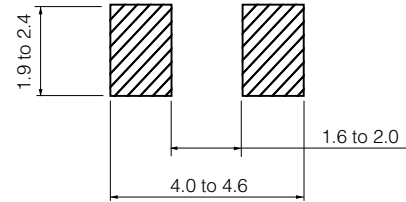

### ■ Standard Packing Quantity

- 2000 pcs./Reel

### ■ Standard Parts

Part No.	Inductance			Q		SRF *1 (MHz) min.	R <sub>bc</sub> *2 (Ω) max.	DC Current (mA) max.
	(nH)	Tolerance (%)	Test Freq. (MHz)	min.	Test Freq. (MHz)			
ELJNA47N□F	47	M : ±20 %	100	10	100	680	0.20	450
ELJNA56N□F	56					600	0.22	420
ELJNA68N□F	68					540	0.25	400
ELJNA82N□F	82					500	0.27	380
ELJNAR10□F	100					450	0.30	360
ELJNAR12□F	120					25.2	25.2	400
ELJNAR15□F	150	350	0.72	230				
ELJNAR18□F	180	320	0.81	220				
ELJNAR22□F	220	280	0.90	210				
ELJNAR27□F	270	250	1.0	200				
ELJNAR33□F	330	K : ±10 % or J : ±5 %	1	13	7.96			220
ELJNAR39□F	390					200	1.2	180
ELJNAR47□F	470					180	1.4	175
ELJNAR56□F	560					160	1.5	170
ELJNAR68□F	680					150	1.7	155
ELJNAR82□F	820					135	1.9	145
ELJNA1R0□F	1000	J : ±5 %	1	13	7.96	120	2.1	125
ELJNA1R2□F	1200					110	2.3	120
ELJNA1R5□F	1500					95	2.7	115
ELJNA1R8□F	1800					85	3.0	110
ELJNA2R2□F	2200					80	3.2	110
ELJNA2R7□F	2700					70	3.6	105
ELJNA3R3□F	3300					62	4.2	100
ELJNA3R9□F	3900					57	4.4	95
ELJNA4R7□F	4700					52	7.7	70
ELJNA5R6□F	5600					46	8.7	65
ELJNA6R8□F	6800	42	10	60				
ELJNA8R2□F	8200	38	11	60				

□ : Symbol of Tolerance \*1 : Self Resonant Frequency \*2 : DC Resistance

■ Packaging Methods (Taping)

● Punched Carrier Tape Dimensions in mm (not to scale)

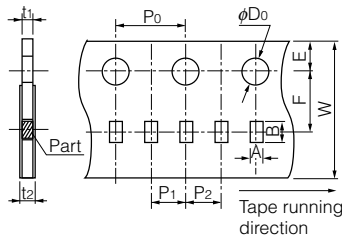

● Embossed Carrier Tape Dimensions in mm (not to scale)

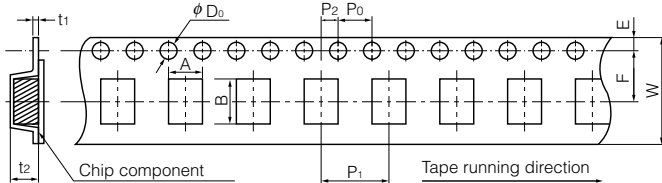
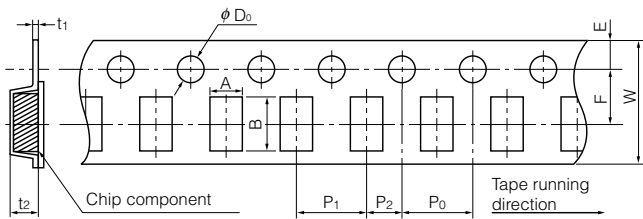
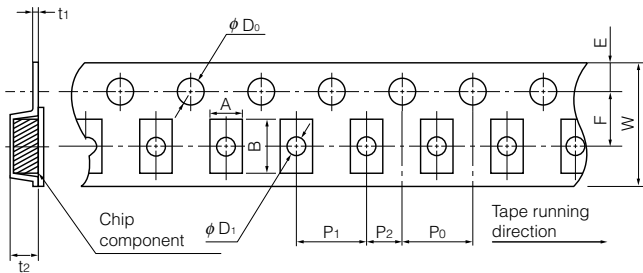

● Taping Reel Dimensions in mm (not to scale)

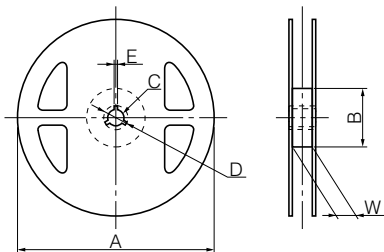

■ Standard Packing Quantity/Reel

Types	Quantity	Quantity
RF, QF, PF		10000 pcs.
RE, QE, PE, ND		3000 pcs.
NC, FC, PC, LC, SC		2000 pcs.
NA, FA, PA, LA, SA, EA, DA		2000 pcs.
FB, PB		500 pcs.

● Type □F

	A	B	W	E	F	P <sub>1</sub>
RF, QF, PF	0.71	1.21	8.0	1.75	3.5	2.0
	P <sub>2</sub>	P <sub>0</sub>	φD <sub>0</sub>	t <sub>1</sub>	t <sub>2</sub>	
RF, QF, PF	2.0	4.0	φ1.5	0.7 max.	1.0 max.	

● Type □E, Type ND, Type □C

	A	B	W	E	F	P <sub>1</sub>
RE, QE, PE	1.0	1.8	8.0	1.75	3.5	4.0
ND	1.45	2.25	8.0	1.75	3.5	4.0
NC, FC, PC, LC, SC	2.40	2.90	8.0	1.75	3.5	4.0
	P <sub>2</sub>	P <sub>0</sub>	φD <sub>0</sub>	φD <sub>1</sub>	t <sub>1</sub>	t <sub>2</sub>
RE, QE, PE	2.0	4.0	φ1.5	φ0.6	(0.27)	1.2
ND	2.0	4.0	φ1.5	φ1.0	(0.25)	1.55
NC, FC, PC, LC, SC	2.0	4.0	φ1.5	φ1.1	(0.25)	1.85

● Type □A

	A	B	W	E	F	P <sub>1</sub>
NA, FA, PA, LA, SA, EA, DA	2.80	3.60	8.0	1.75	3.5	4.0
	P <sub>2</sub>	P <sub>0</sub>	φD <sub>0</sub>	t <sub>1</sub>	t <sub>2</sub>	
NA, FA, PA, LA, SA, EA, DA	2.0	4.0	φ1.5	(0.25)	2.40	

● Type □B

	A	B	W	E	F	P <sub>1</sub>
FB, PB	3.60	4.90	12.0	1.75	5.5	8.0
	P <sub>2</sub>	P <sub>0</sub>	φD <sub>0</sub>	t <sub>1</sub>	t <sub>2</sub>	
FB, PB	2.0	4.0	φ1.5	(0.30)	3.50	

Types	Parts					
	A	B	C	D	E	W
RF, QF, PF, RE, QE, PE, ND, NC, FC, PC, LC, SC, NA, FA, PA, LA, SA, EA, DA	180	60	13	21	2	9
FB, PB	180	60	13	21	2	13

\* Under conditions of high temperature and humidity deterioration of the taping and packaging may be accelerated.  
Please carefully control storage conditions and use the product within 6 months of receipt.

## Soldering Conditions

### ■ Reflow soldering conditions

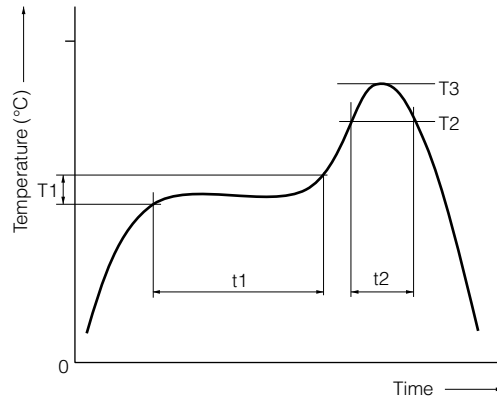

### ● Pb free solder recommended temperature profile

Type	Preheat		Soldering		Peak Temperature		Time of Reflow
	T1 [°C]	t1 [s]	T2 [°C]	t2 [s]	T3	T3 Limit	
□F	150 to 180	60 to 120	230 °C	40 max.	250 °C, 10 s	260 °C, 10 s	2 times max.
□E	150 to 180	60 to 120	230 °C	40 max.	250 °C, 10 s	260 °C, 10 s	2 times max.
□D	150 to 180	60 to 120	230 °C	40 max.	245 °C, 10 s	250 °C, 10 s	2 times max.
□C	150 to 180	60 to 120	230 °C	40 max.	245 °C, 10 s	250 °C, 10 s	2 times max.
□A	150 to 180	60 to 120	230 °C	40 max.	245 °C, 10 s	250 °C, 10 s	2 times max.
□B	150 to 180	60 to 120	230 °C	40 max.	245 °C, 10 s	250 °C, 10 s	2 times max.

### ■ Flow soldering conditions

Preheat: 130 to 150 °C, 60 to 180 s, Soldering: 260 °C, 5 s max.

### ■ Notes

- Solderability may be reduced due to the conditions of high temperature and high humidity which causes the oxidation of tin-plated terminals. Even if storage conditions are within specified limits, solderability may be reduced with the passage of time. Therefore, please control the storage conditions and try to use the product within 6 months of receipt.
- In case the product has been stored for a period longer than 6 months, use the product only after confirmation of its solderability.

## ⚠ Safety Precautions (Common precautions for Chip Inductors)

- When using our products, no matter what sort of equipment they might be used for, be sure to make a written agreement on the specifications with us in advance. The design and specifications in this catalog are subject to change without prior notice.
- Do not use the products beyond the specifications described in this catalog.
- This catalog explains the quality and performance of the products as individual components. Before use, check and evaluate their operations when installed in your products.
- Install the following systems for a failsafe design to ensure safety if these products are to be used in equipment where a defect in these products may cause the loss of human life or other significant damage, such as damage to vehicles (automobile, train, vessel), traffic lights, medical equipment, aerospace equipment, electric heating appliances, combustion/gas equipment, rotating equipment, and disaster/crime prevention equipment.
- \* Systems equipped with a protection circuit and a protection device
- \* Systems equipped with a redundant circuit or other system to prevent an unsafe status in the event of a single fault

## ⚠ Precautions for use

### 1. Operation range and environments

- ① These products are designed and manufactured for general and standard use in general electronic equipment (e.g. AV equipment, home electric appliances, office equipment, information and communication equipment)
- ② These products are not intended for use in the following special conditions. Before using the products, carefully check the effects on their quality and performance, and determine whether or not they can be used.
  - In liquid, such as water, oil, chemicals, or organic solvent
  - In direct sunlight, outdoors, or in dust
  - In salty air or air with a high concentration of corrosive gas, such as Cl<sub>2</sub>, H<sub>2</sub>S, NH<sub>3</sub>, SO<sub>2</sub>, or NO<sub>2</sub>
  - In an environment where these products cause dew condensation

### 2. Handling

- ① Do not bring magnets or magnetized materials close to the product. The influence of their magnetic field can change the inductance value.
- ② Do not apply strong mechanical shocks by either dropping or collision with other parts.  
Excessive shock can damage the part.

### 3. Land pattern design

- ① Please refer to the recommended land pattern for each type shown on the datasheet.
- ② Avoid placing the chip inductor on any metal pattern except the recommended land pattern because a drop of Q and mutual conductance may occur.
- ③ In case of flow soldering, venting of soldering flux gases should be made for high density assemblies to get a good solder connection.
- ④ In case of reflow soldering, consider the layout because taller components close to chip inductor tend to block thermal conduction.

### 4. Mounting

- ① In general, magnetic and electric characteristics of ferrite cores can be changed by applying excessively strong force. Placement force should not exceed 20 N.
- ② Do not bend or twist the PWB after mounting the part.

### 5. Cleaning

- ① Do not use acid or alkali agents. Some cleaning solvents may damage the part.  
Confirm by testing the reliability in advance of mass production.
- ② If Ultrasonic cleaning is used, please confirm the reliability in advance.  
It is possible that combined resonance of component and PWB and cavitation can cause an abnormal vibration mode to exist causing damage.

### 6. Caution about applying excessive current

The rated current is defined as the smaller value of either the current value when the inductance drops 10 % down from the initial point or the current value when the average temperature of coil inside rises 20 °C up from the initial point. Do not operate product over the specific max. current.

### <Package markings>

Package markings include the product number, quantity, and country of origin.  
In principle, the country of origin should be indicated in English.

Chip Inductors

Type: F, E, D, C, A, B

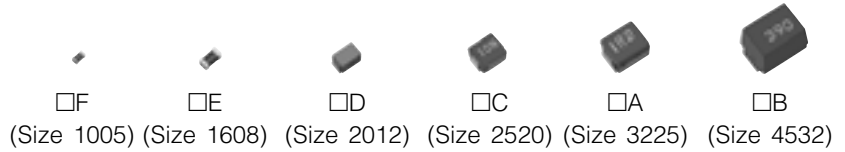

Ceramic Core/Laser-Cut and wire wound type chip inductors for automatic and high-density mounting  
Wide variation product line-up correspond to various needs

■ Recommended Applications

- Cellular phones, wireless communication equipment (W-LAN, Bluetooth), various modules, HIC, TV, VTR, PC & peripherals, DVD, DSC, STB.

■ Inductors · Selection Guide

Size : mm (inch)

Technology Case Usage	Non wound		Wire wound			
	Size 1005 (0402)	Size 1608 (0603)	Size 2012 (0805)	Size 2520 (1008)	Size 3225 (1210)	Size 4532 (1812)
High Freq. Use	ELJRF  1.0–100 nH	ELJRE  1.0–220 nH	ELJND  10–1000 nH	ELJNC  10–820 nH	ELJNA  47–8200 nH	
High Freq. High-Q	ELJQF  1.0–39 nH	ELJQE  2.2–56 nH				
General Use				ELJFC  0.22–100 μH	ELJFA  0.22–220 μH	ELJFB  0.22–1000 μH
High Power	ELJPF  2.2–10 nH	ELJPE  2.2–22 nH		ELJPC/PC□3 ELJLC  1.0–33 μH	ELJPA/PA□2 ELJLA  1.0–330 μH	ELJPB  10–220 μH
Magnetically Shielded				ELJSC  27–100 μH	ELJSA  10–270 μH	
Low DC Resistance					ELJEA  1.0–330 μH	
Signal Processing Use (Low Distortion Type)					ELJDA/ELJFA  39–100 μH	

Design and specifications are each subject to change without notice. Ask factory for the current technical specifications before purchase and/or use.  
Should a safety concern arise regarding this product, please be sure to contact us immediately.

## OUR CERTIFICATE

DiGi provide top-quality products and perfect service for customer worldwide through standardization, technological innovation and continuous improvement. DiGi through third-party certification, we stricly control the quality of products and services. Welcome your RFQ to

Email: [Info@DiGi-Electronics.com](mailto:Info@DiGi-Electronics.com)



Tel: +00 852-30501935

RFQ Email: [Info@DiGi-Electronics.com](mailto:Info@DiGi-Electronics.com)

DiGi is a global authorized distributor of electronic components.