

# ELL-6SH2R7M Datasheet



<https://www.DiGi-Electronics.com>

DiGi Electronics Part Number	ELL-6SH2R7M-DG
Manufacturer	<a href="#">Panasonic Electronic Components</a>
Manufacturer Product Number	ELL-6SH2R7M
Description	FIXED IND 2.7UH 2.4A 31 MOHM SMD
Detailed Description	2.7 $\mu$ H Shielded Wirewound Inductor 2.4 A 31mOhm Nonstandard



Tel: +00 852-30501935

RFQ Email: [Info@DiGi-Electronics.com](mailto:Info@DiGi-Electronics.com)

DiGi is a global authorized distributor of electronic components.



## Purchase and inquiry

Manufacturer Product Number:

ELL-6SH2R7M

Series:

H

Type:

Wirewound

Inductance:

2.7  $\mu$ H

Current Rating (Amps):

2.4 A

Shielding:

Shielded

Q @ Freq:

-

Ratings:

-

Inductance Frequency - Test:

100 kHz

Package / Case:

Nonstandard

Size / Dimension:

0.252" L x 0.236" W (6.40mm x 6.00mm)

Base Product Number:

ELL-6SH

Manufacturer:

Panasonic Electronic Components

Product Status:

Obsolete

Material - Core:

-

Tolerance:

$\pm$ 20%

Current - Saturation (Isat):

-

DC Resistance (DCR):

31mOhm

Frequency - Self Resonant:

-

Operating Temperature:

-

Mounting Type:

Surface Mount

Supplier Device Package:

-

Height - Seated (Max):

0.130" (3.30mm)

## Environmental & Export classification

RoHS Status:

ROHS3 Compliant

ECCN:

EAR99

Moisture Sensitivity Level (MSL):

1 (Unlimited)

HTSUS:

8504.50.8000

## Power Inductors / Wire Wound type

Discontinued

Series : **H**  
 Type : **ELL6RH**  
           **ELL6SH**  
           **ELL6UH**

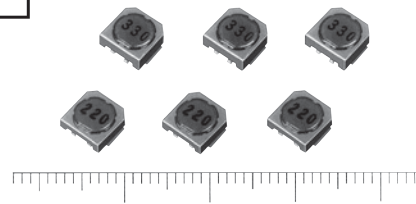

### Features

- Thin (height 2.5 mm, 3.0 mm)
- Higher reliability in mounting by separating the user terminal and internal connection.
- Large current capability
- RoHS compliant

### Recommended Applications

- Audiovisual equipment, Small portable device, DC/DC converter circuit for amusement machine

### Cautionary Notes Regarding Usage in DC/DC converters

- Maximum Dissipation of 1 W.
- Maximum case temperature of 105 °C (Ambient & self-heating temperature)

### Standard Packing Quantity

- 1,000 pcs./reel

### As for Soldering Conditions and Safety Precautions,

Please see Data Files

### Explanation of Part Numbers

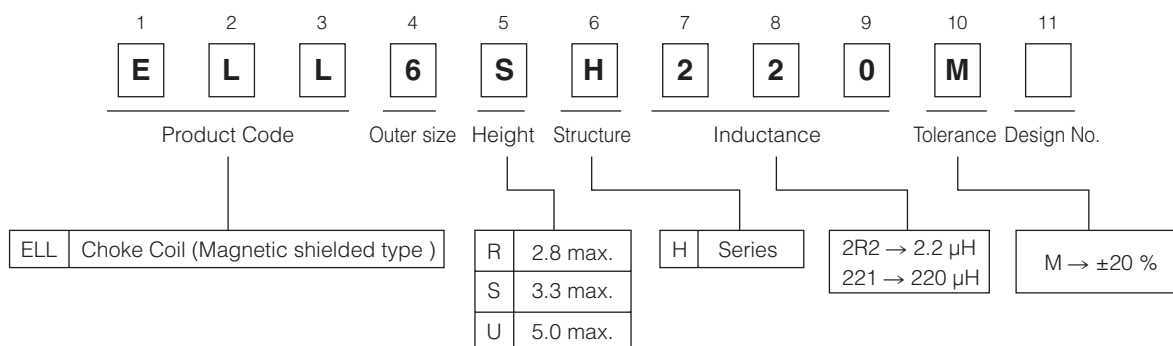

**Discontinued**

**Dimensions in mm (not to scale)**

**Connections (Top view)**

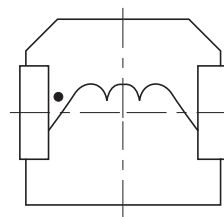
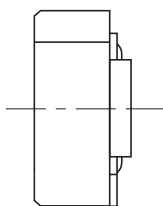
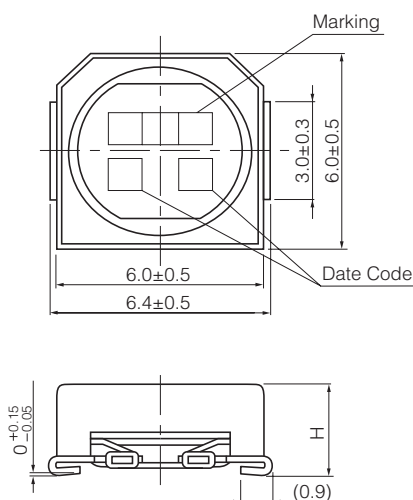

**Recommended land patterns in mm (not to scale)**

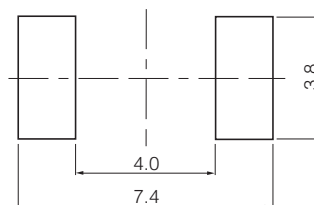

Type	H
ELL6RH	2.5 mm±0.3 mm
ELL6SH	3.0 mm±0.3 mm
ELL6UH	5.0 mm max.

**Standard Parts**

Part No.	Inductance (μH) at 100 kHz Tol. ±20 %	R <sub>DC</sub> (mΩ) at 20 °C Tol. ±20 %		Rated Current* (mA) max.		Marking
		6RH	6SH	6RH	6SH	
ELL6□H1R0M	1.0	19	19	3000	3400	1R0
ELL6□H1R5M	1.5	24	24	2400	3200	1R5
ELL6□H2R0M	2.0	—	26	—	2600	2R0
ELL6□H2R2M	2.2	30	—	2300	—	2R2
ELL6□H2R7M	2.7	39	31	1800	2400	2R7
ELL6□H3R3M	3.3	44	34	1600	2200	3R3
ELL6□H4R7M	4.7	49	42	1580	2000	4R7
ELL6□H5R1M	5.1	56	—	1550	—	5R1
ELL6□H5R6M	5.6	—	49	—	1800	5R6
ELL6□H6R2M	6.2	62	—	1400	—	6R2
ELL6□H6R8M	6.8	—	52	—	1500	6R8
ELL6□H7R5M	7.5	80	—	1250	—	7R5
ELL6□H8R2M	8.2	87	61	1200	1400	8R2
ELL6□H100M	10.0	95	65	1100	1300	100
ELL6□H120M	12.0	130	71	1000	1200	120
ELL6□H150M	15.0	150	96	850	1100	150
ELL6□H180M	18.0	170	130	800	1000	180
ELL6□H220M	22.0	220	140	700	900	220
ELL6□H270M	27.0	260	160	650	800	270
ELL6□H330M	33.0	380	180	600	700	330
ELL6□H390M	39.0	410	240	550	650	390
ELL6□H470M	47.0	480	270	500	600	470
ELL6□H560M	56.0	540	290	450	550	560
ELL6□H680M	68.0	770	520	400	500	680
ELL6□H820M	82.0	870	600	350	450	820
ELL6□H101M	100.0	1000	680	300	400	101
ELL6□H121M	120.0	1500	750	280	370	121
ELL6□H151M	150.0	1800	860	250	350	151
ELL6□H181M	180.0	2000	1300	230	300	181
ELL6□H221M	220.0	2300	1400	200	280	221
ELL6□H271M	270.0	—	2400	—	260	271
ELL6□H331M	330.0	—	2700	—	240	331
ELL6□H391M	390.0	—	2800	—	210	391
ELL6□H471M	470.0	—	3200	—	200	471
ELL6□H561M	560.0	—	3700	—	180	561
ELL6□H681M	680.0	—	4300	—	160	681

\* Current : This indicates the value of current when the inductance is 80% of nominal value or when the case temperature has risen 45 °C.

**Discontinued**

**Standard Parts**

Part No.	Inductance (μH) at 100 kHz Tol. ±20 %	R <sub>bc</sub> (mΩ) at 20 °C Tol. ±20 %	Rated Current* (mA) max.	Marking
ELL6UH100M	10.0	63	1800	100
ELL6UH120M	12.0	71	1700	120
ELL6UH150M	15.0	79	1600	150
ELL6UH180M	18.0	88	1400	180
ELL6UH220M	22.0	98	1300	220
ELL6UH270M	27.0	110	1200	270
ELL6UH330M	33.0	130	1100	330
ELL6UH390M	39.0	150	1000	390
ELL6UH470M	47.0	160	900	470
ELL6UH560M	56.0	210	800	560
ELL6UH680M	68.0	230	700	680
ELL6UH820M	82.0	260	650	820
ELL6UH101M	100.0	360	600	101
ELL6UH121M	120.0	480	580	121
ELL6UH151M	150.0	680	500	151
ELL6UH181M	180.0	750	470	181
ELL6UH221M	220.0	840	410	221
ELL6UH271M	270.0	1200	370	271
ELL6UH331M	330.0	1360	330	331
ELL6UH391M	390.0	1500	300	391
ELL6UH471M	470.0	1680	270	471
ELL6UH561M	560.0	2530	260	561
ELL6UH681M	680.0	2830	240	681
ELL6UH821M	820.0	3140	200	821
ELL6UH102M	1000.0	3670	180	102

\* Current : This indicates the value of current when the inductance is 70% of nominal value or when the case temperature has risen 45 °C.

**Embossed Carrier Tape Dimensions in mm (not to scale)**

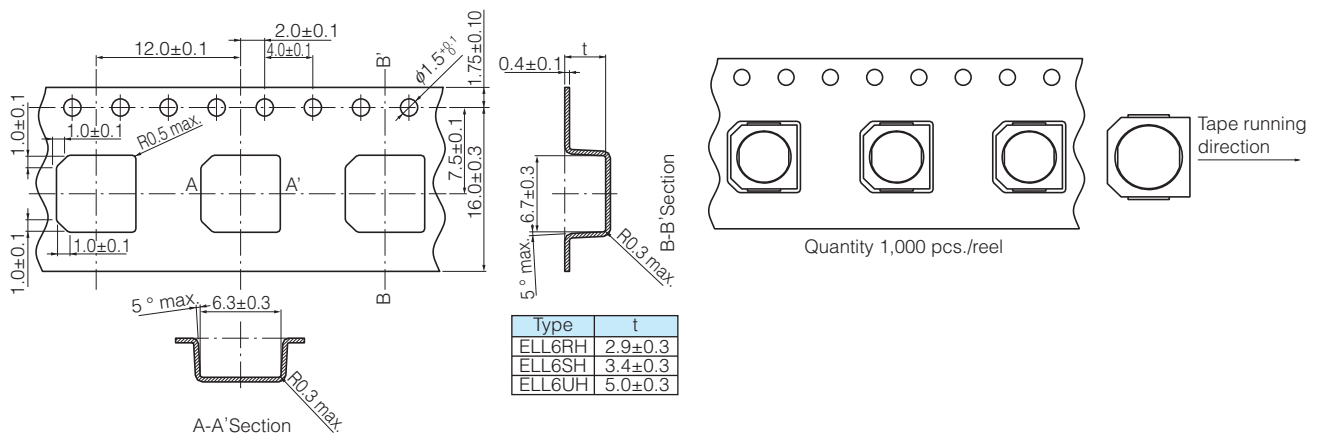

**⚠ Safety Precautions****(Common precautions for Power Inductors / Wire Wound type)**

- When using our products, no matter what sort of equipment they might be used for, be sure to make a written agreement on the specifications with us in advance. The design and specifications in this catalog are subject to change without prior notice.
  - Do not use the products beyond the specifications described in this catalog.
  - This catalog explains the quality and performance of the products as individual components. Before use, check and evaluate their operations when installed in your products.
  - Install the following systems for a failsafe design to ensure safety if these products are to be used in equipment where a defect in these products may cause the loss of human life or other significant damage, such as damage to vehicles (automobile, train, vessel), traffic lights, medical equipment, aerospace equipment, electric heating appliances, combustion/gas equipment, rotating equipment, and disaster/crime prevention equipment.
- \*Systems equipped with a protection circuit and a protection device  
 \*Systems equipped with a redundant circuit or other system to prevent an unsafe status in the event of a single fault

**⚠ Precautions for use****1. Operation range and environments**

- ① These products are designed and manufactured for general and standard use in general electronic equipment (e.g. AV equipment, home electric appliances, office equipment, information and communication equipment)
- ② These products are not intended for use in the following special conditions. Before using the products, carefully check the effects on their quality and performance, and determine whether or not they can be used.
  - In liquid, such as water, oil, chemicals, or organic solvent
  - In direct sunlight, outdoors, or in dust
  - In salty air or air with a high concentration of corrosive gas, such as Cl<sub>2</sub>, H<sub>2</sub>S, NH<sub>3</sub>, SO<sub>2</sub>, or NO<sub>2</sub>
  - In an environment where these products cause dew condensation

**2. Handling**

- ① Do not bring magnets or magnetized materials close to the product. The influence of their magnetic field can change the inductance value.
- ② Do not apply strong mechanical shocks by either dropping or collision with other parts. Excessive shock can damage the part.

**3. Washing of board**

Kindly consult the Technical department before washing of the PWB with any cleansing agent, and provide the washing condition.

**4. Resoldering with a soldering iron**

The temperature of the tip of the soldering iron should be 360 °C or less, 4 seconds.  
 And resoldering with a soldering iron should be limited to 1 time, and after that should be cooling these.

**5. Mounting side**

External force must be less than 5.0 [N] : while mounting.

**6. Storage conditions**

Normal temperature (–5 to 35 °C), normal humidity (85 % RH max.), shall not be exposed to direct sunlight and harmful gases and care should be taken so as not to cause dew.

**<Package markings>**

Package markings include the product number, quantity, and country of origin.  
 In principle, the country of origin should be indicated in English.



## OUR CERTIFICATE

DiGi provide top-quality products and perfect service for customer worldwide through standardization, technological innovation and continuous improvement. DiGi through third-party certification, we stricly control the quality of products and services. Welcome your RFQ to

Email: [Info@DiGi-Electronics.com](mailto:Info@DiGi-Electronics.com)



Tel: +00 852-30501935

RFQ Email: [Info@DiGi-Electronics.com](mailto:Info@DiGi-Electronics.com)

DiGi is a global authorized distributor of electronic components.